

Circle - Inscribed angles

Decide if angle is inscribed and name the central angle and the arc between

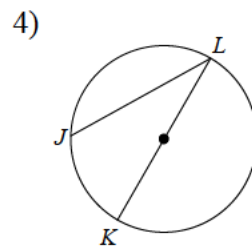

5)

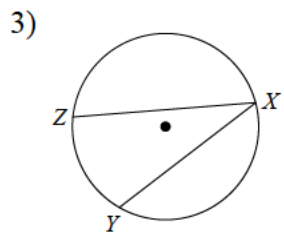
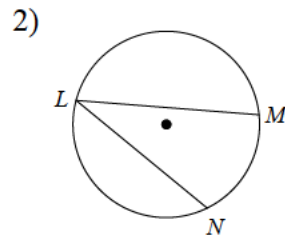
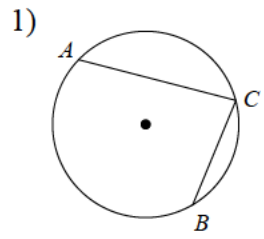
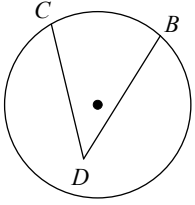

6)

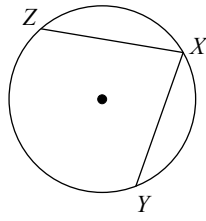

7)

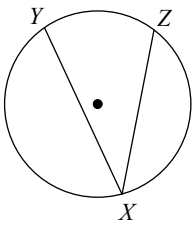

8)

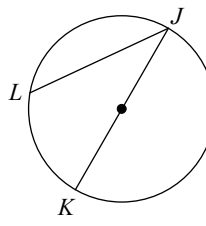

9)

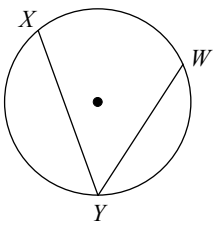

10)

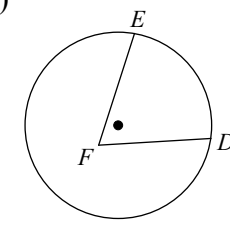

11)

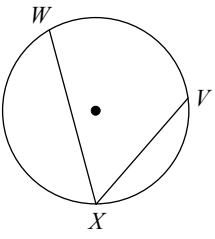

12)

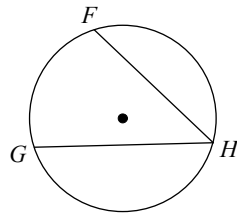

13)

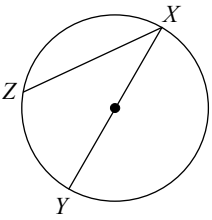

14)

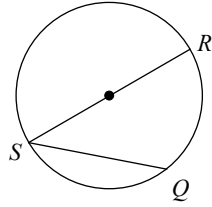

15)

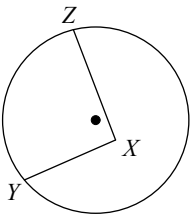

16)

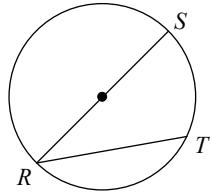

17)

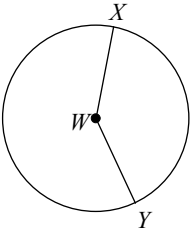

18)

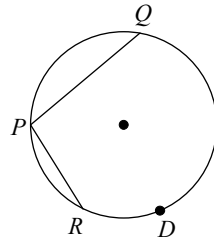

19)

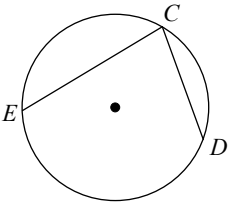

20)

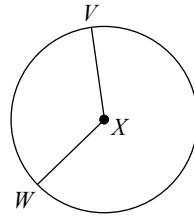

21)

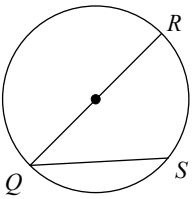

22)

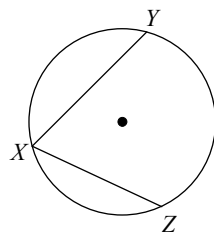

23)

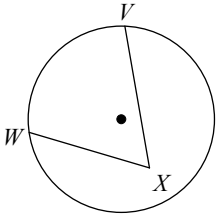

24)

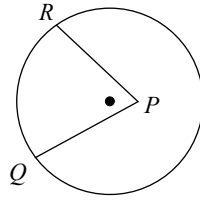

25)

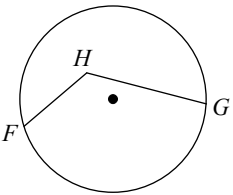

26)

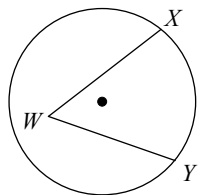

27)

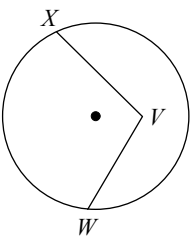

28)

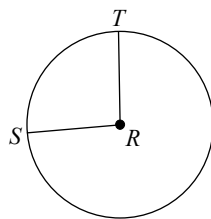

29)

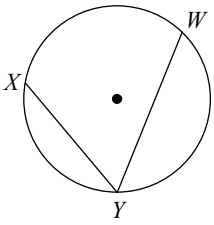

30)

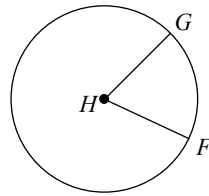

31)

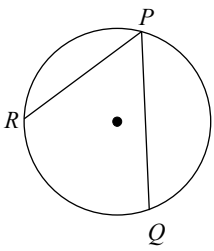

32)

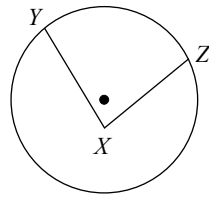

33)

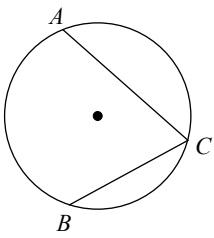

34)

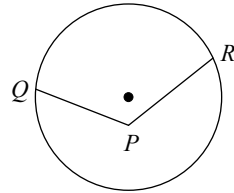

35)

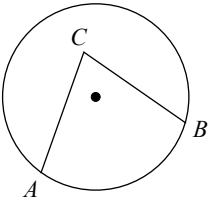

36)

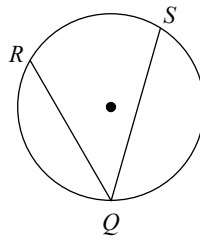

37)

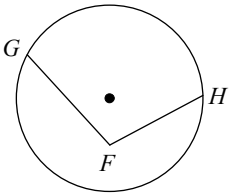

38)

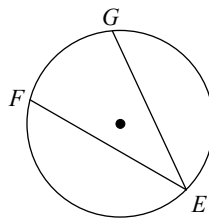

39)

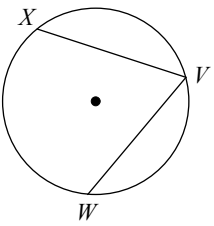

40)

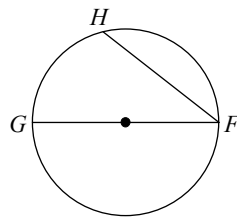

41)

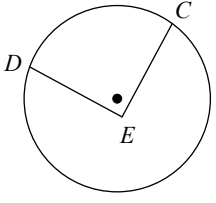

42)

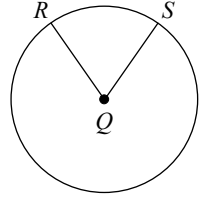

43)

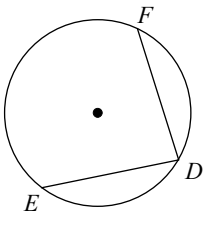

44)

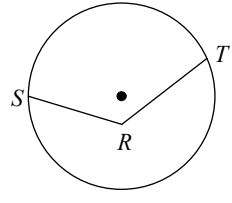

45)

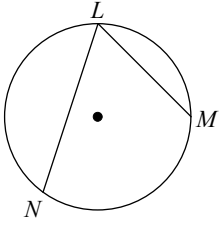

46)

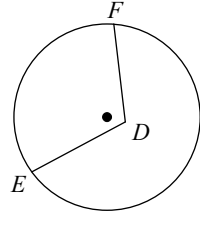

47)

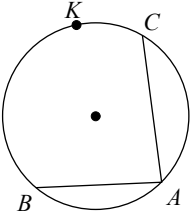

48)

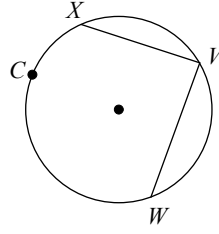

49)

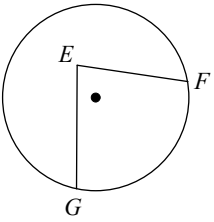

50)

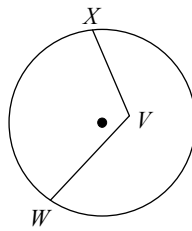

51)

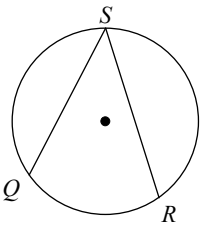

52)

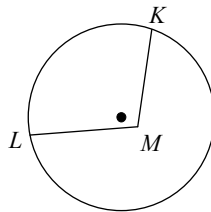

53)

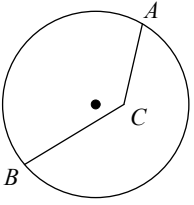

54)

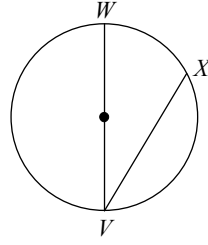

55)

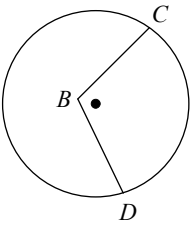

56)

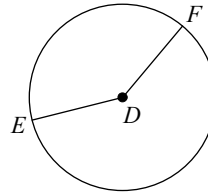

57)

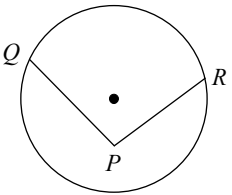

58)

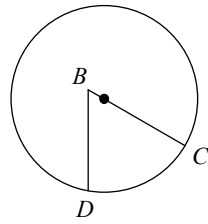

59)

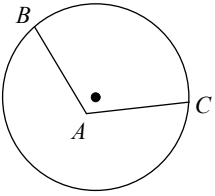

60)

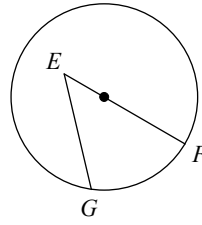

Find the measure of inscribed angle

61)

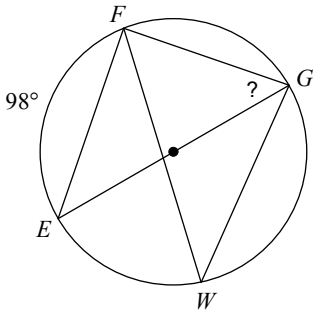

62)

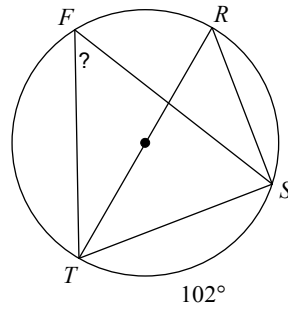

63)

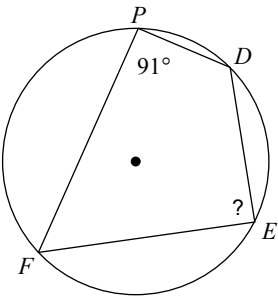

64)

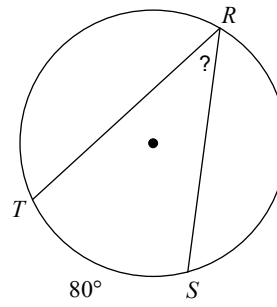

65)

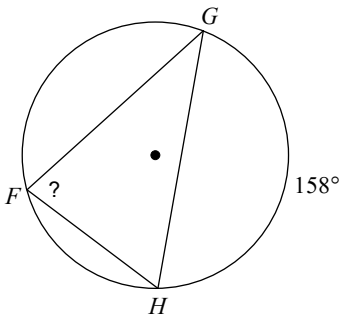

66)

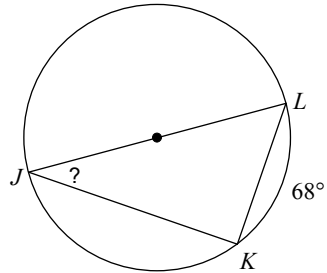

67)

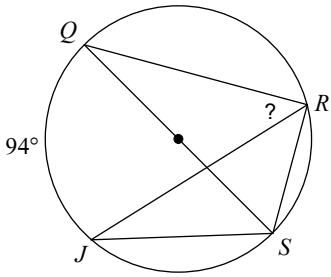

68)

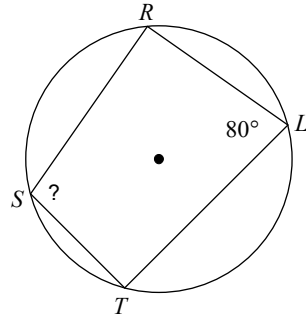

69)

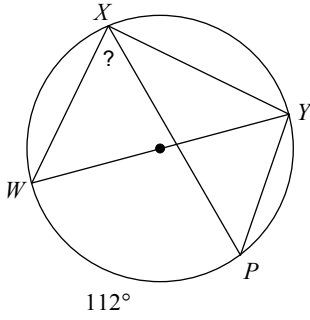

70)

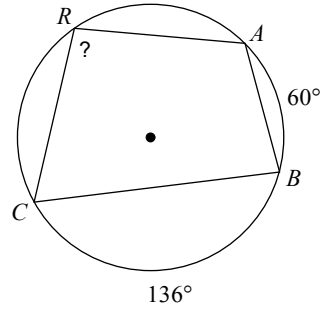

71)

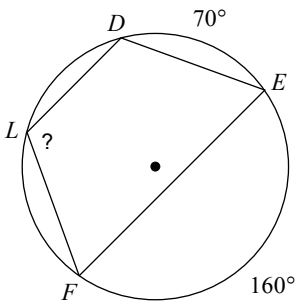

72)

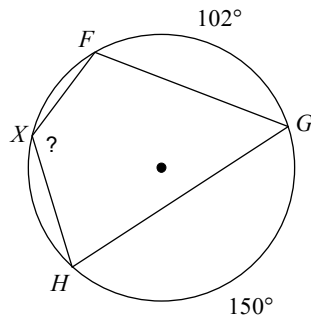

73)

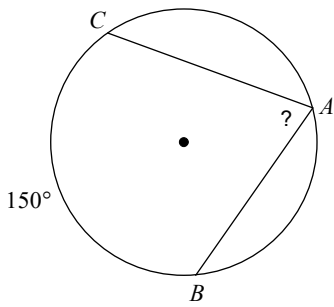

74)

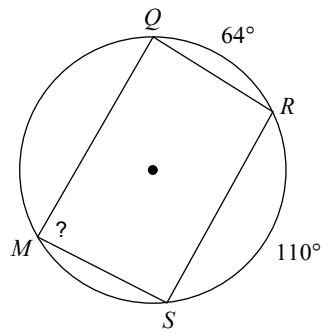

75)

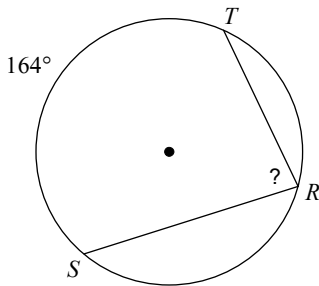

76)

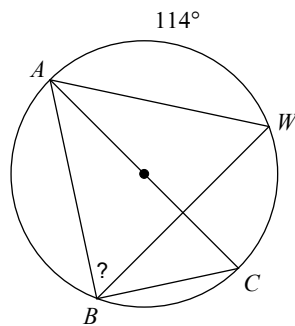

77)

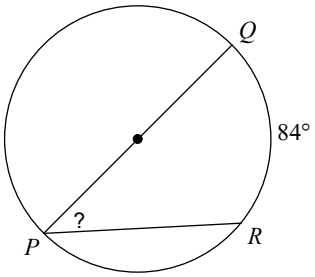

78)

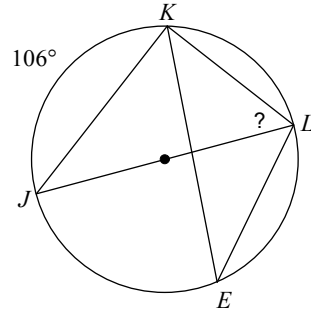

79)

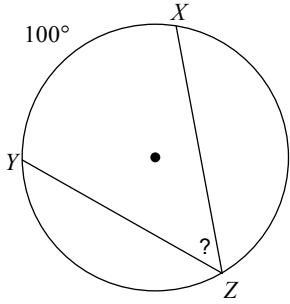

80)

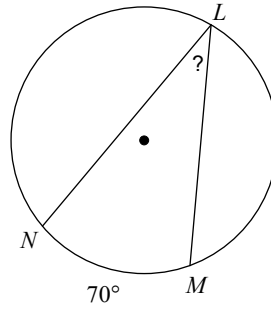

81)

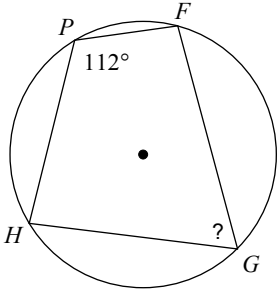

82)

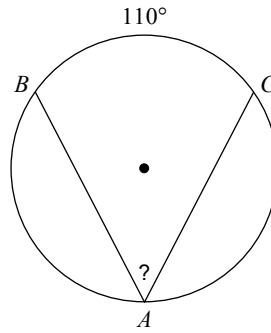

83)

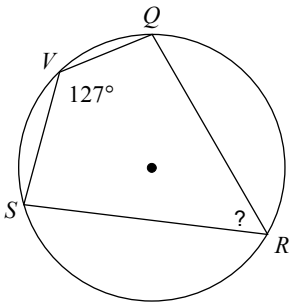

84)

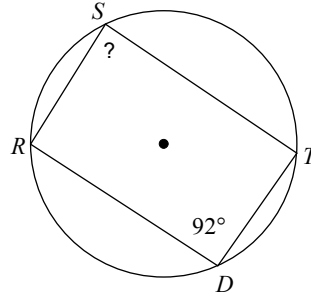

85)

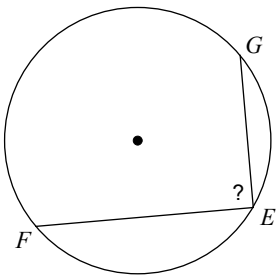

86)

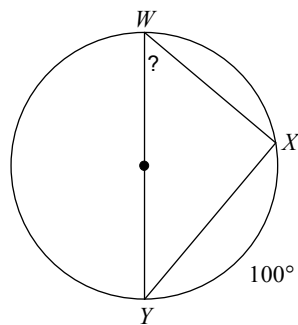

87)

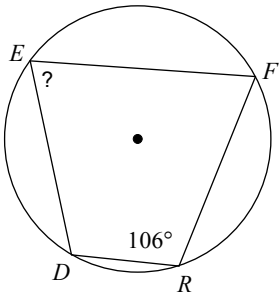

88)

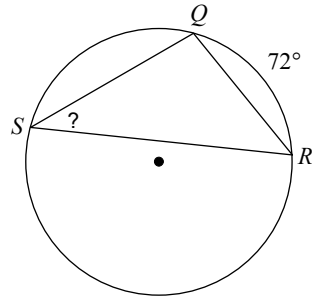

89)

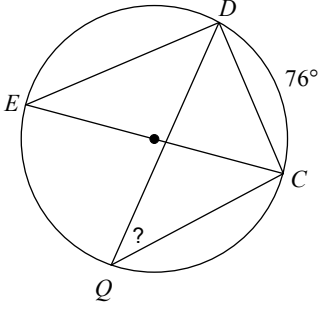

90)

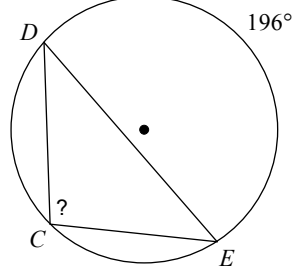

91)

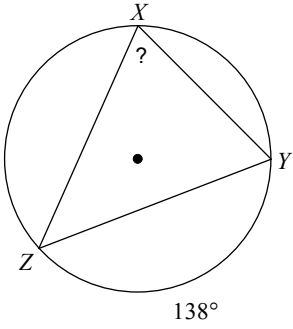

92)

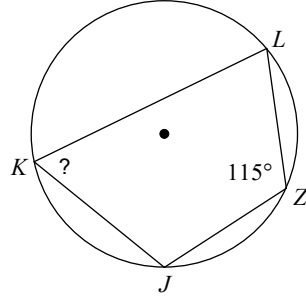

93)

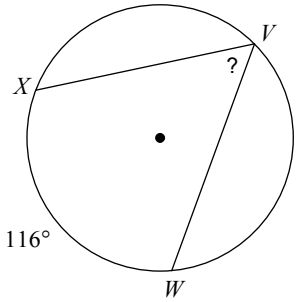

94)

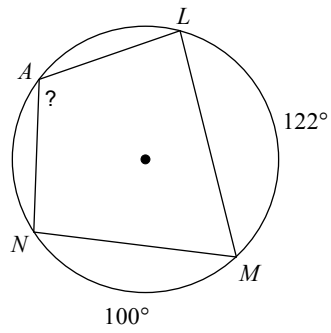

95)

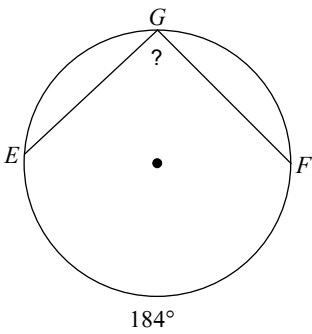

96)

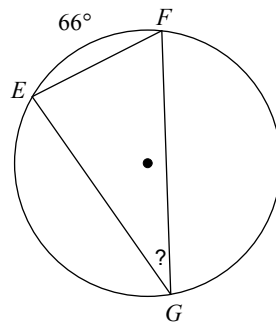

97)

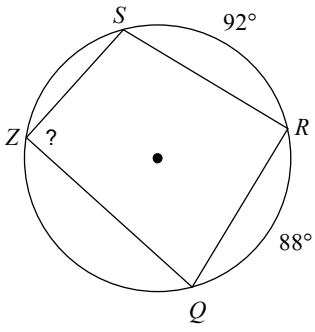

98)

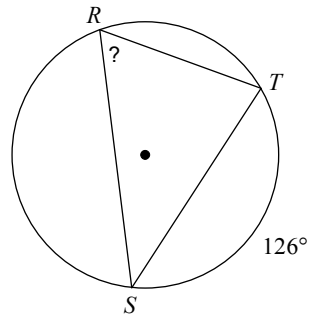

99)

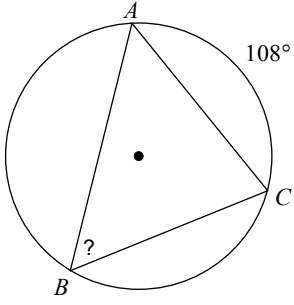

100)

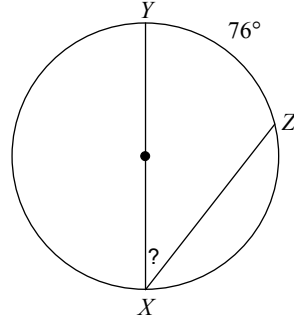

101)

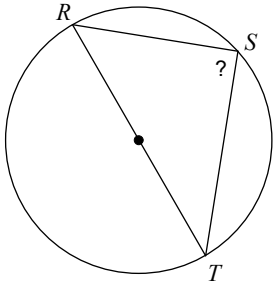

102)

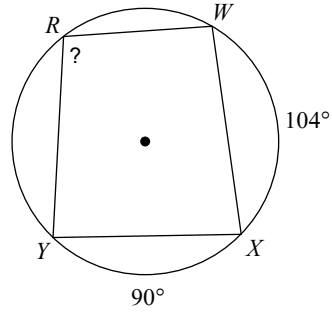

103)

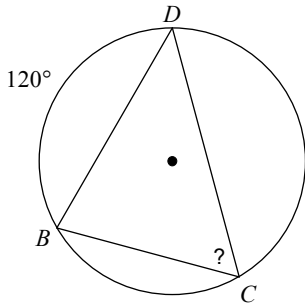

104)

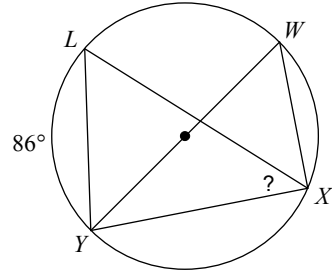

105)

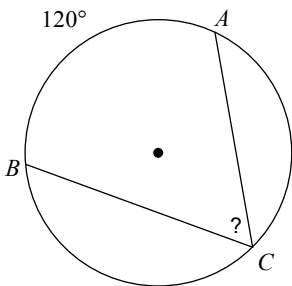

106)

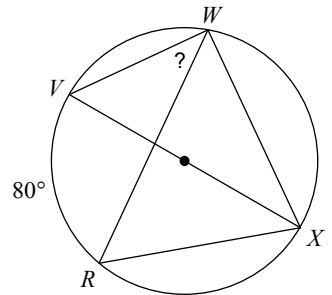

107)

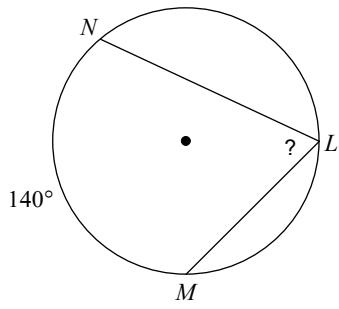

108)

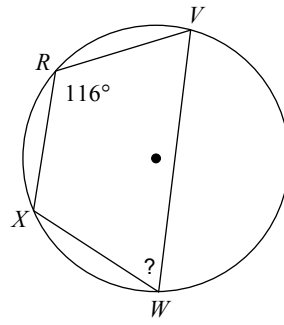

109)

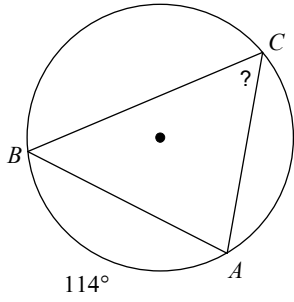

110)

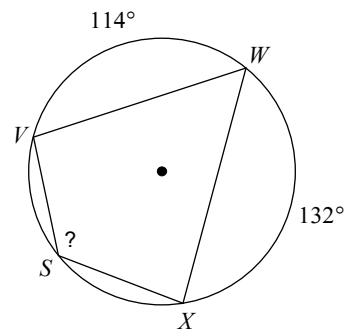

111)

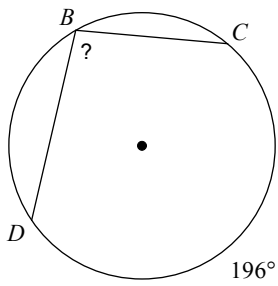

112)

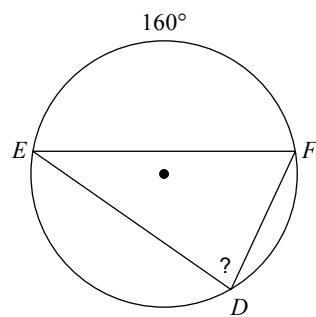

113)

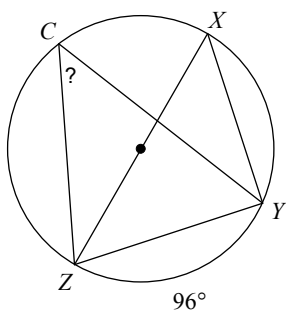

114)

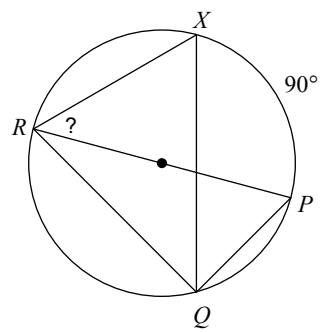

115)

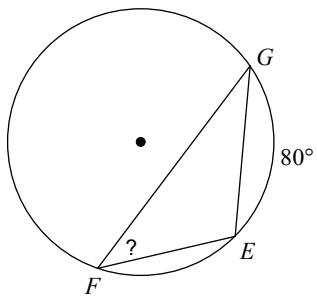

116)

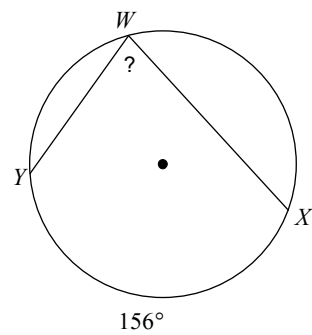

117)

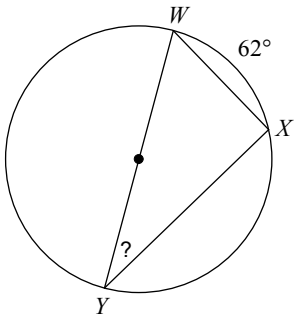

118)

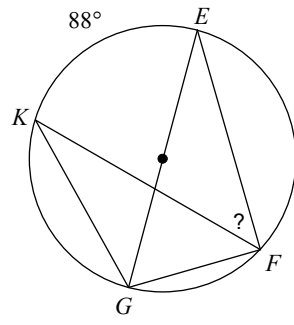

119)

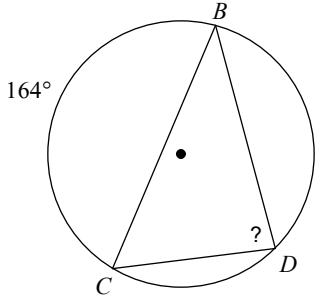

120)

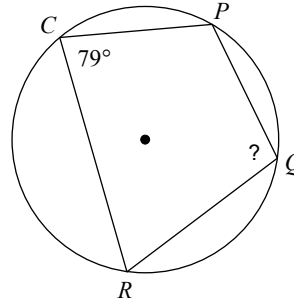

121)

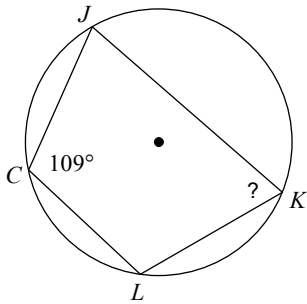

122)

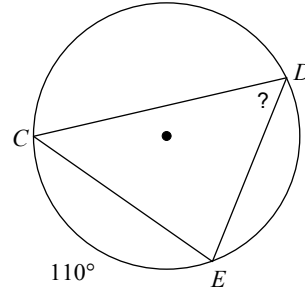

123)

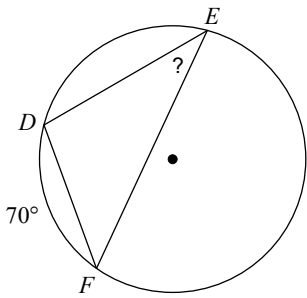

124)

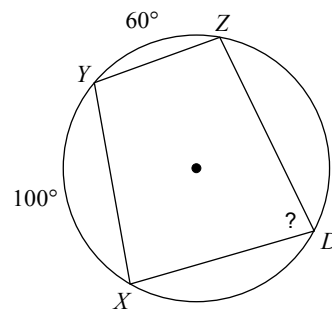

125)

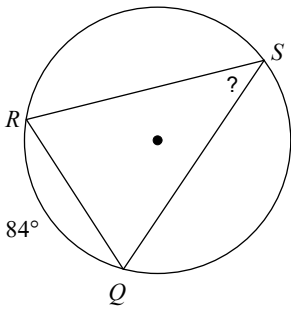

126)

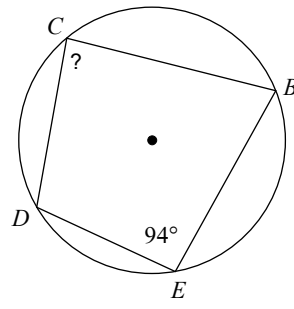

127)

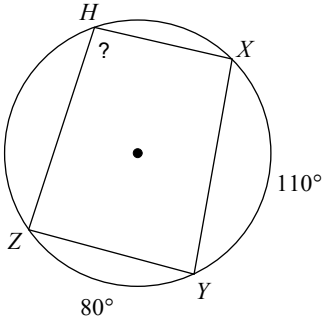

128)

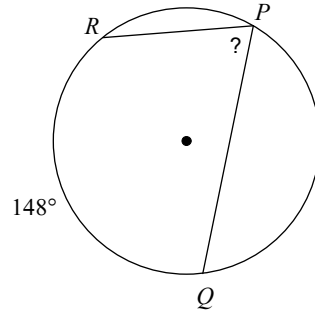

129)

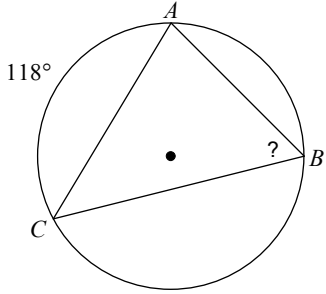

130)

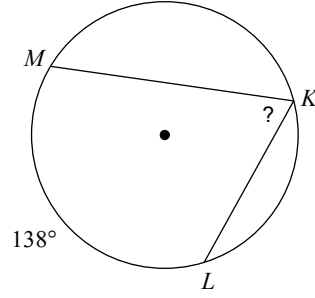

131)

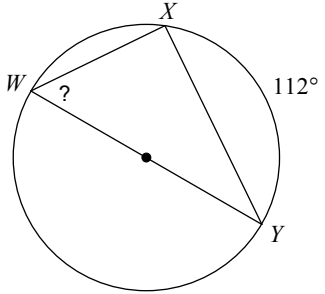

132)

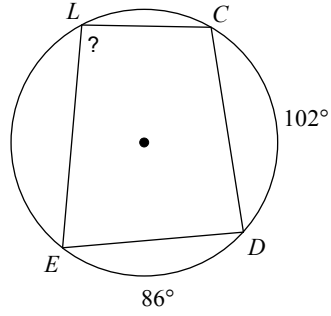

133)

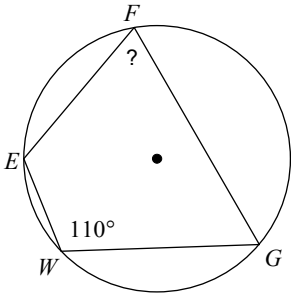

134)

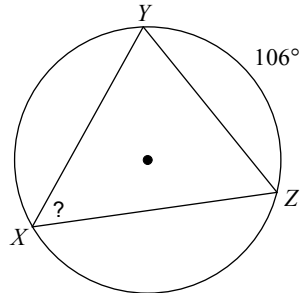

135)

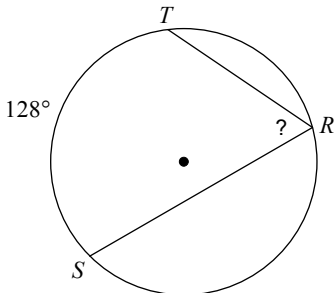

136)

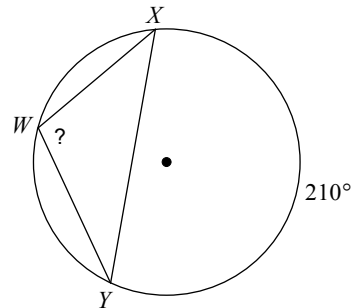

137)

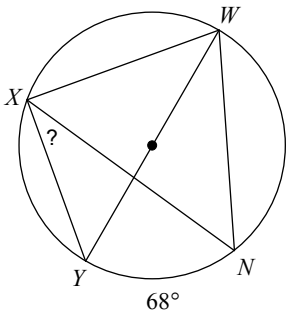

138)

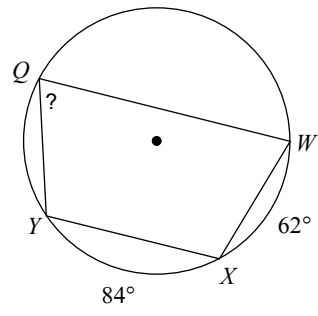

139)

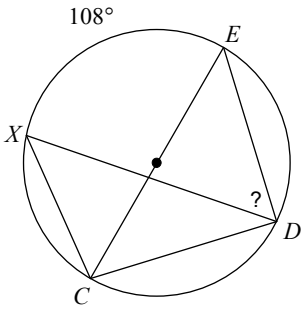

140)

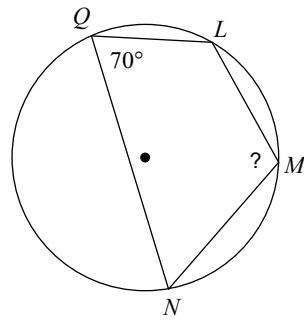

141)

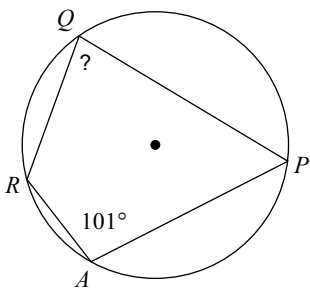

142)

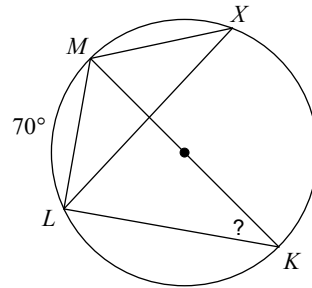

143)

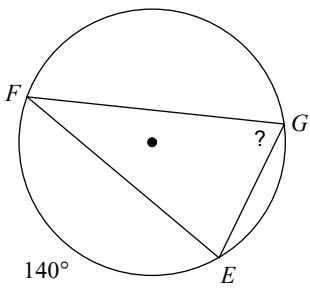

144)

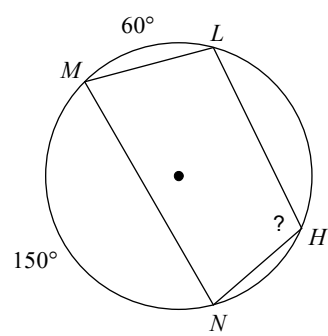

145)

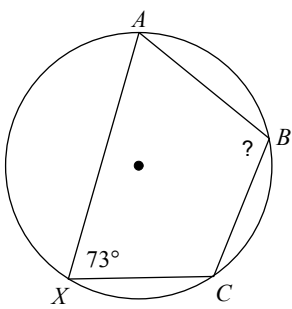

146)

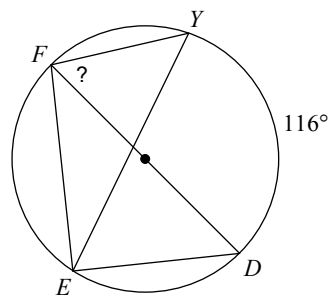

147)

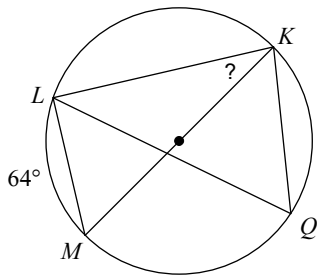

148)

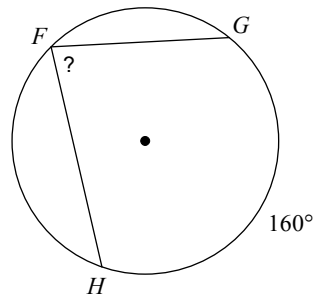

149)

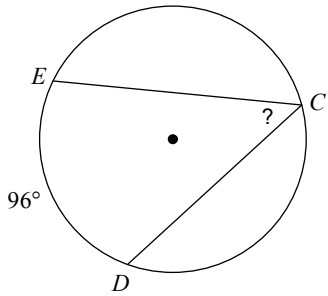

150)

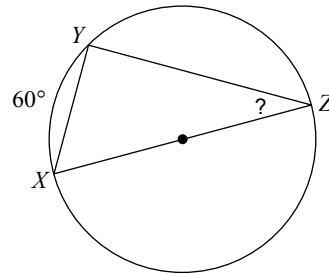

151)

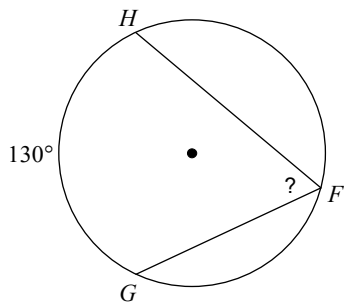

152)

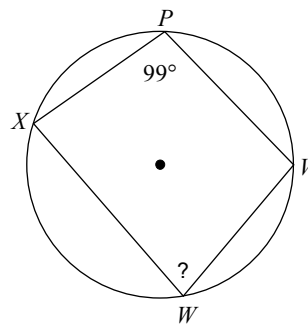

153)

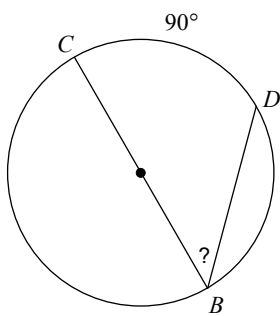

154)

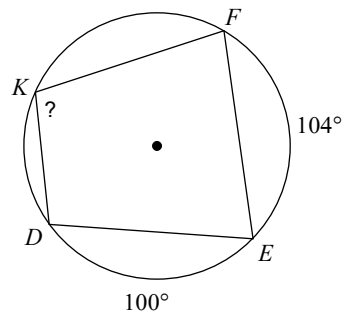

155)

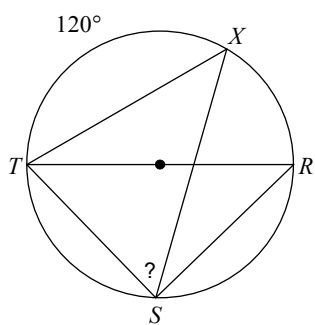

156)

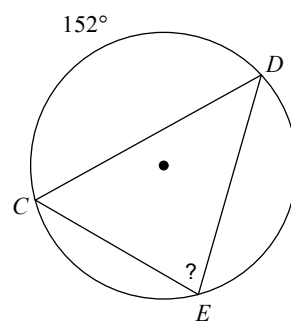

157)

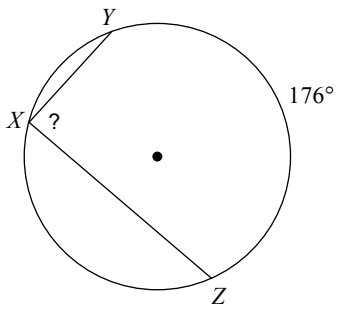

158)

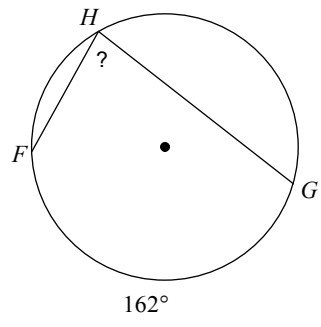

159)

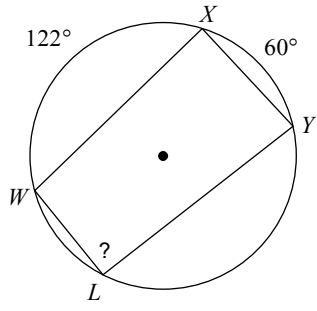

160)

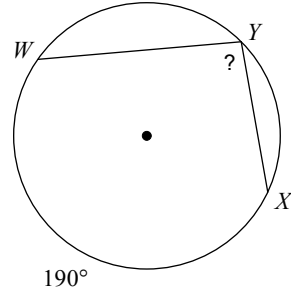

161)

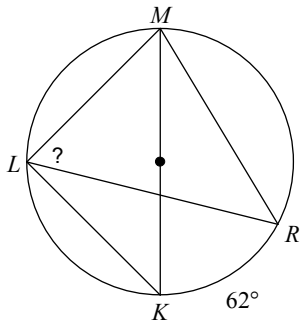

162)

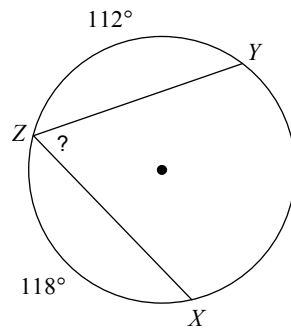

163)

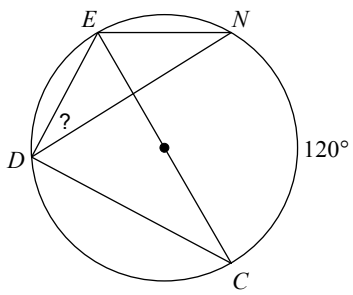

164)

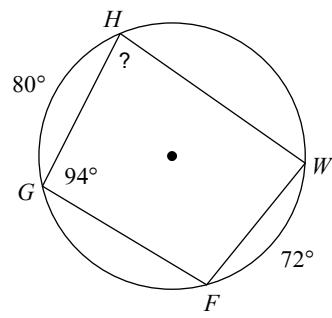

165)

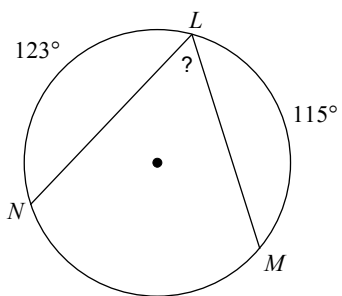

166)

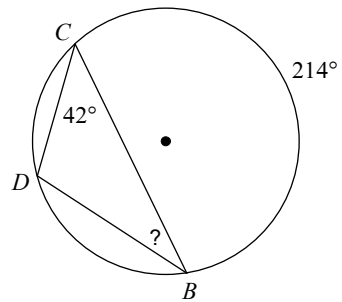

167)

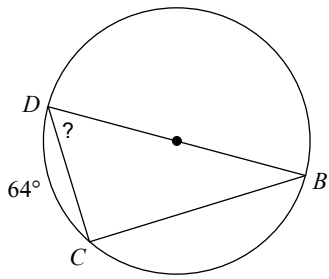

168)

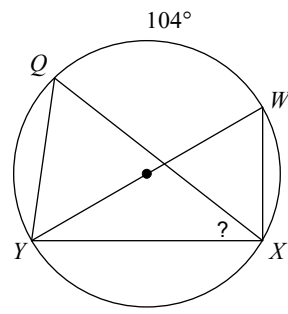

169)

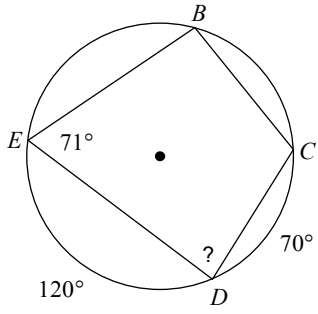

170)

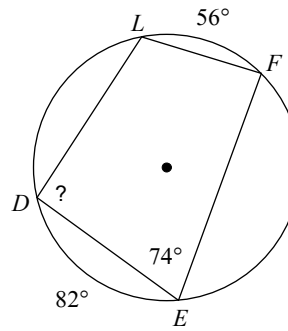

171)

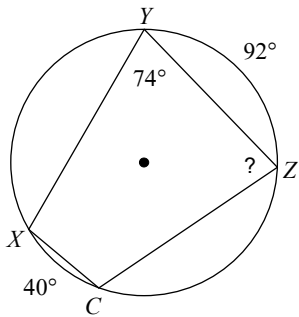

172)

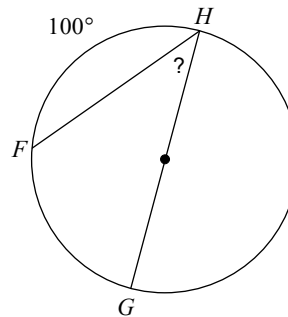

173)

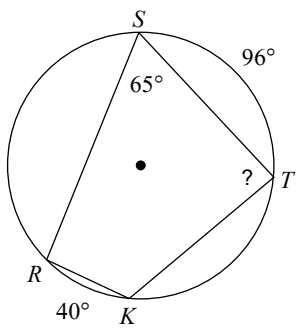

174)

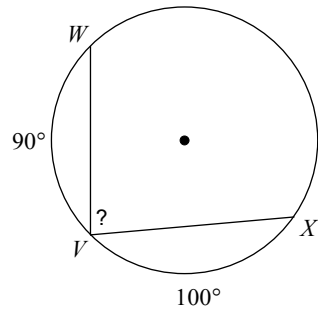

175)

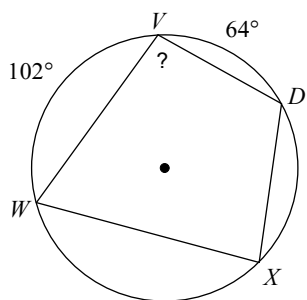

176)

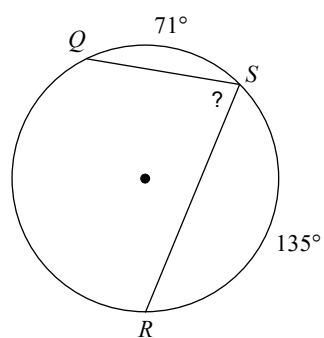

177)

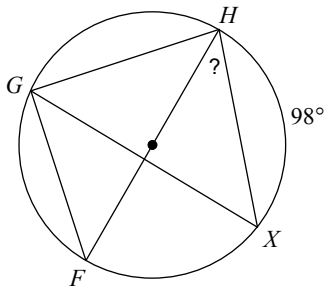

178)

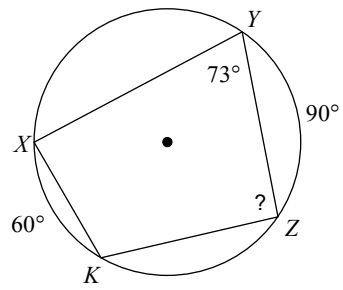

179)

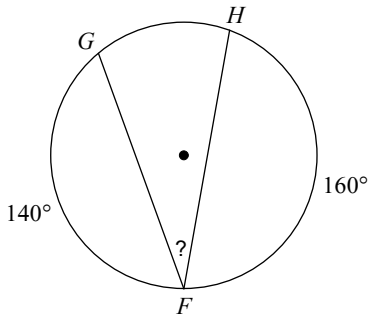

180)

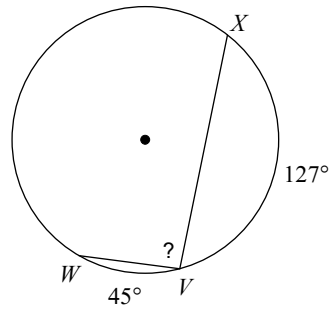

181)

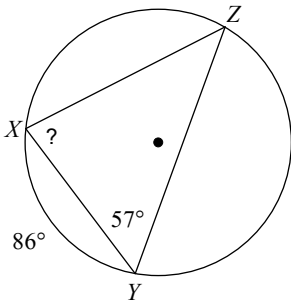

182)

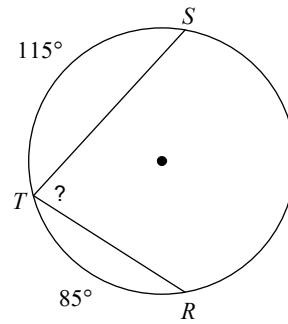

183)

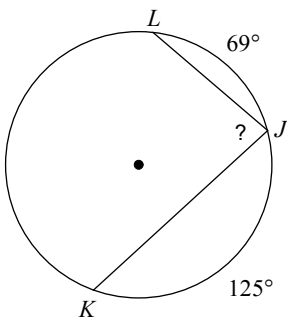

184)

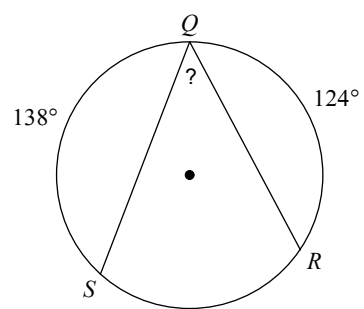

185)

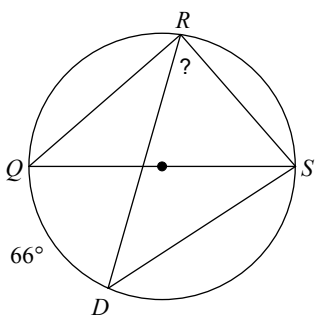

186)

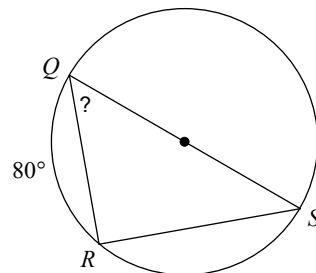

187)

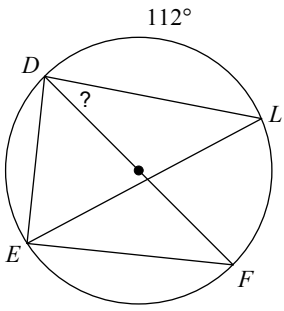

188)

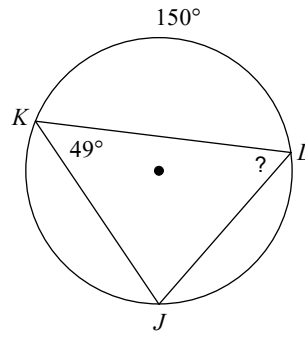

189)

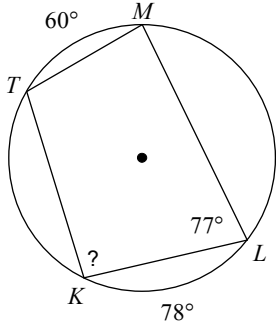

190)

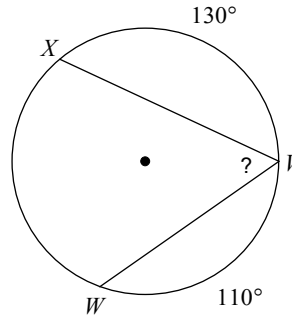

191)

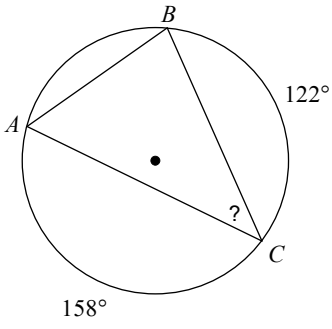

192)

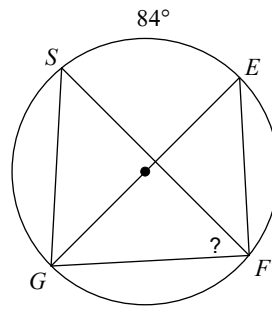

193)

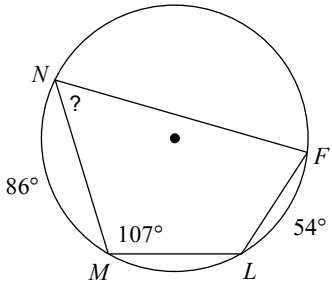

194)

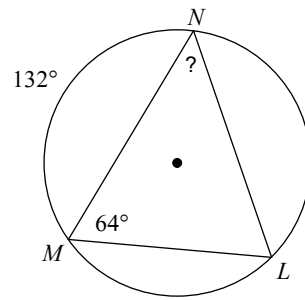

195)

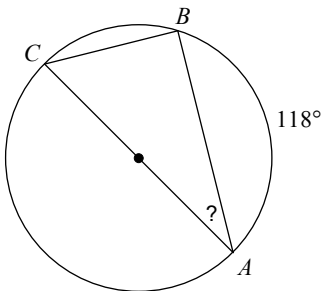

196)

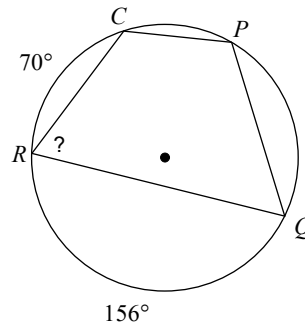

197)

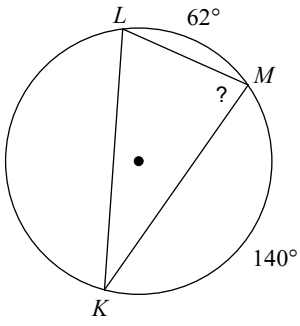

198)

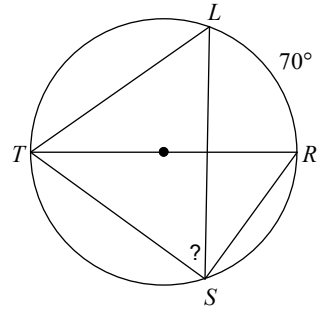

199)

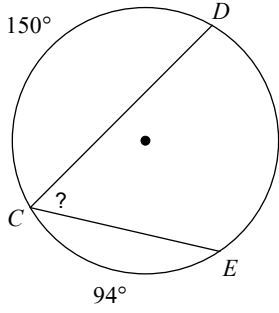

200)

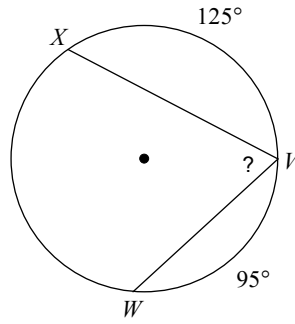

201)

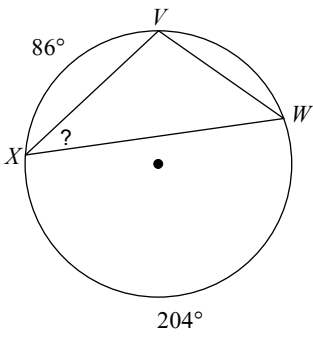

202)

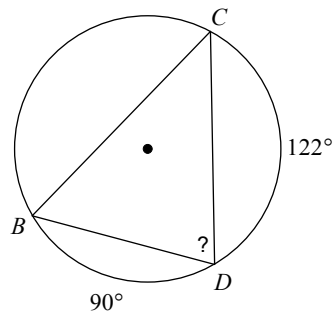

203)

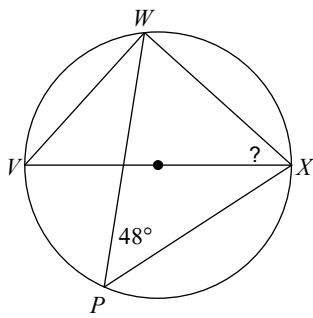

204)

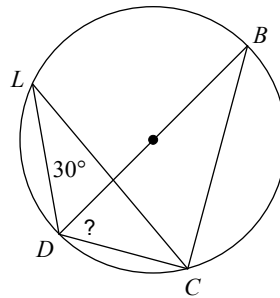

205)

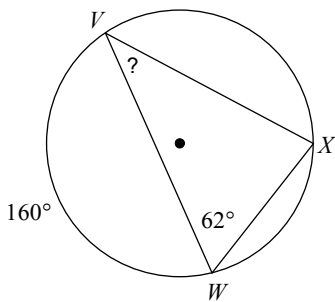

206)

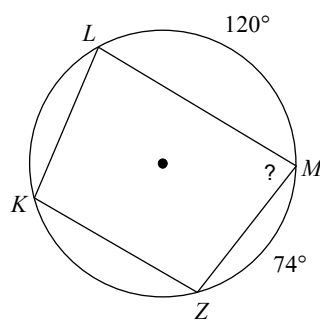

207)

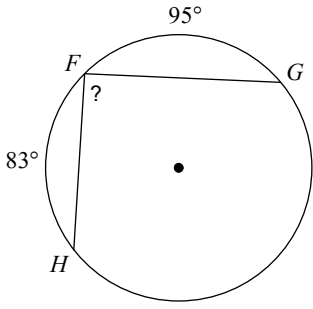

208)

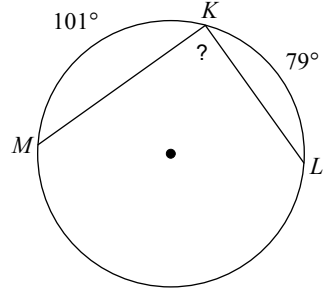

209)

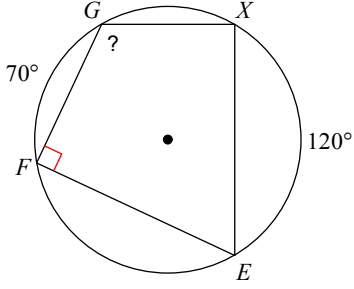

210)

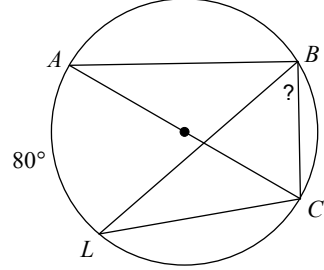

211)

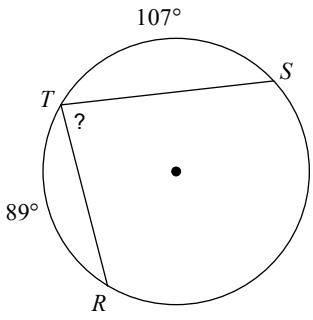

212)

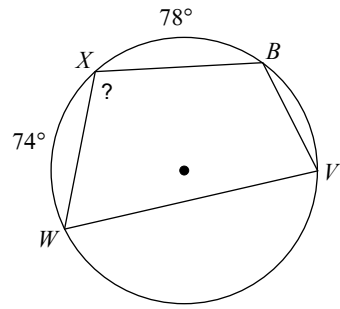

213)

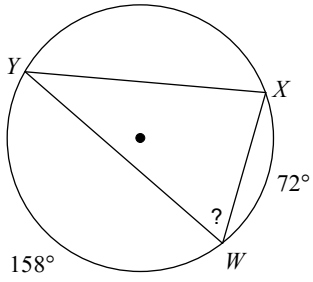

214)

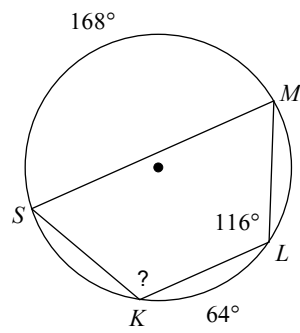

215)

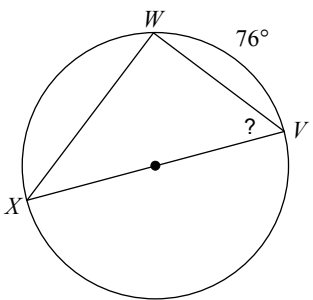

216)

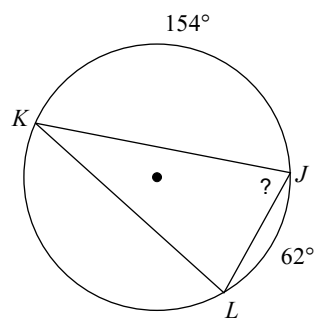

217)

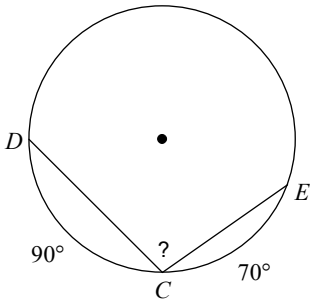

218)

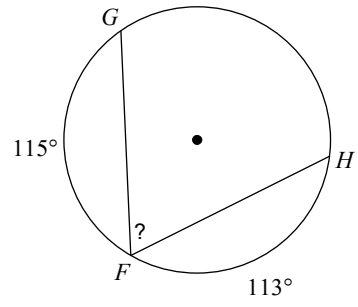

219)

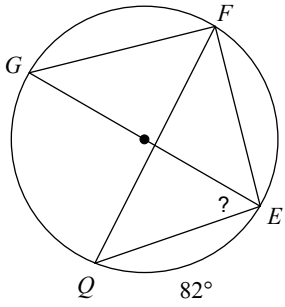

220)

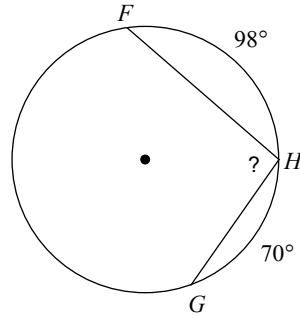

221)

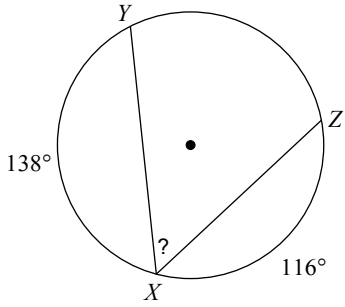

222)

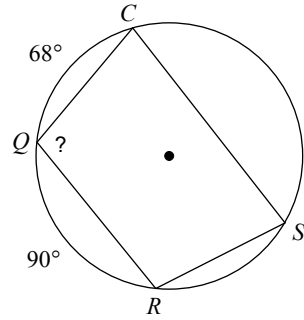

223)

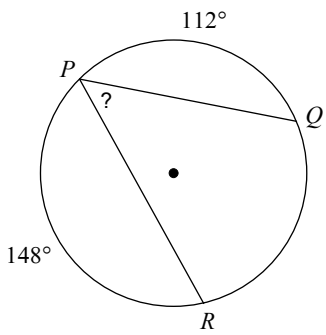

224)

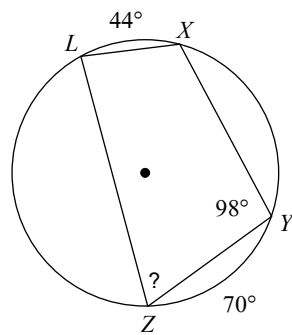

225)

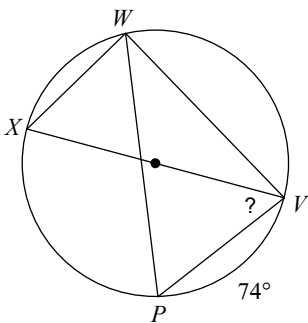

226)

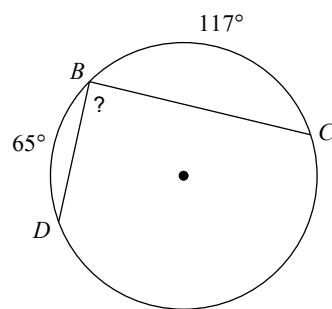

227)

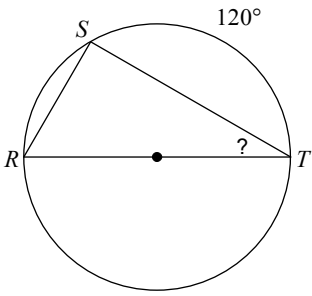

228)

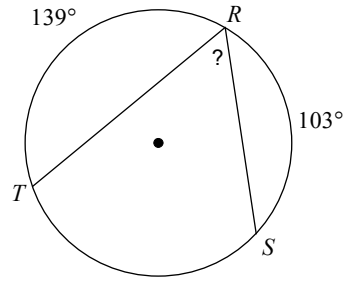

229)

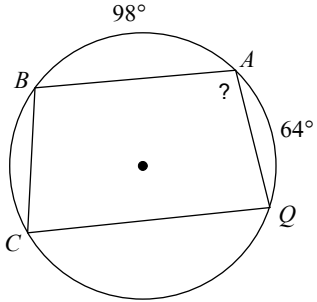

230)

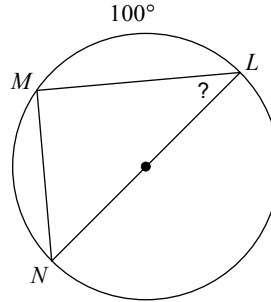

231)

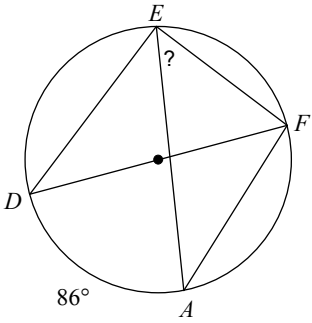

232)

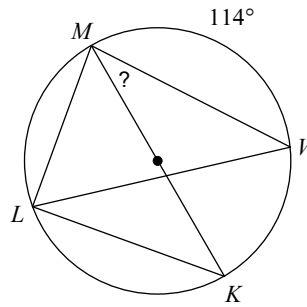

233)

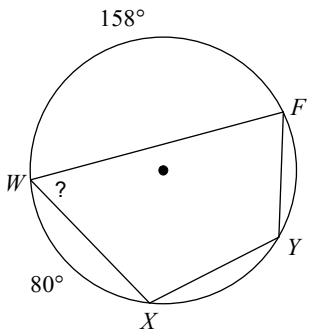

234)

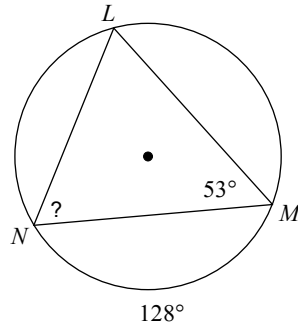

235)

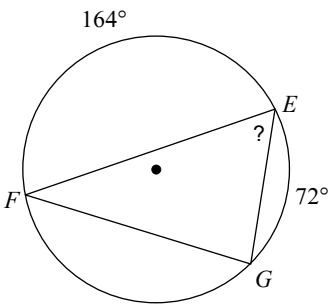

236)

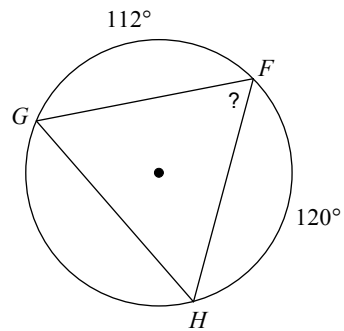

237)

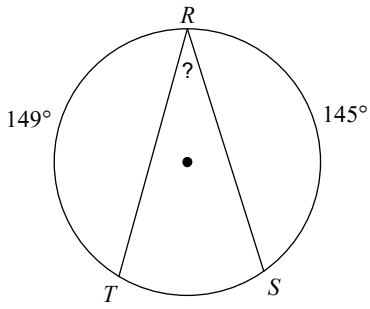

238)

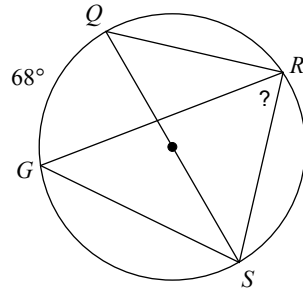

239)

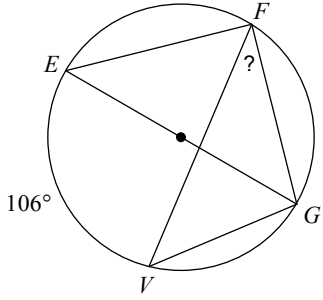

240)

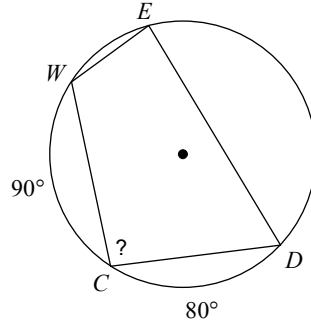

241)

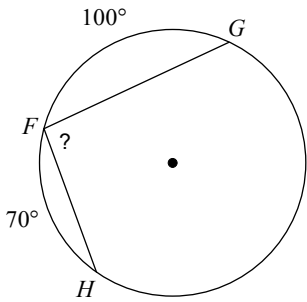

242)

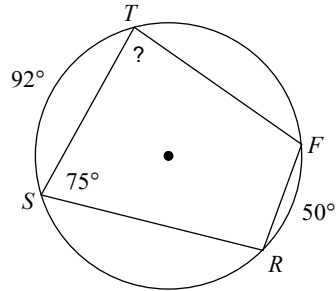

243)

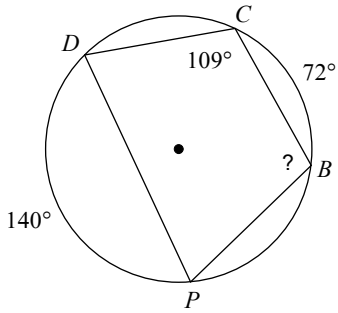

244)

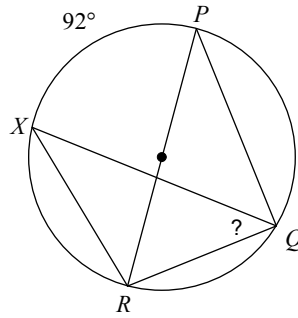

245)

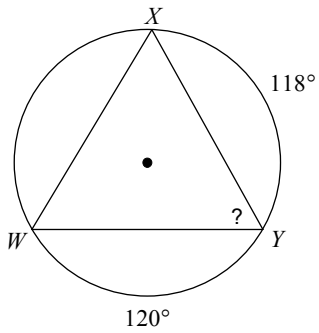

246)

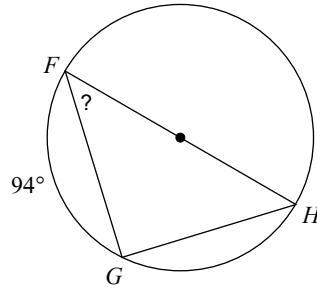

247)

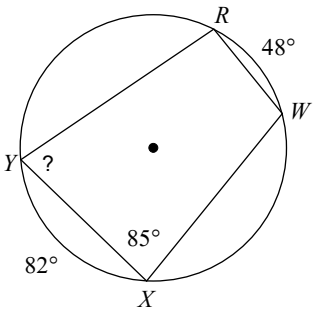

248)

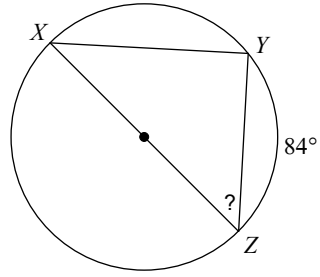

249)

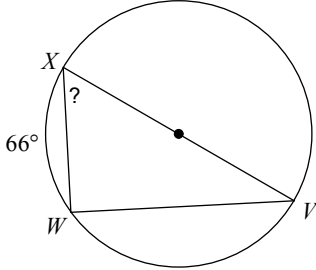

250)

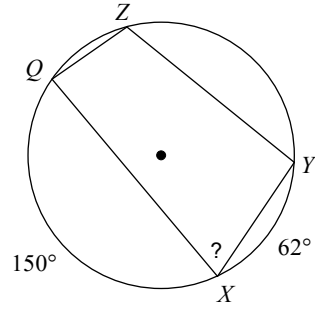

251)

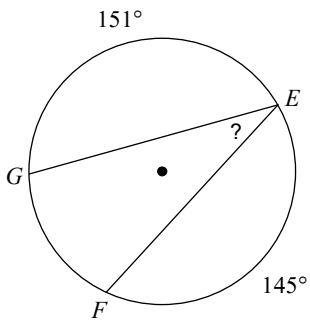

252)

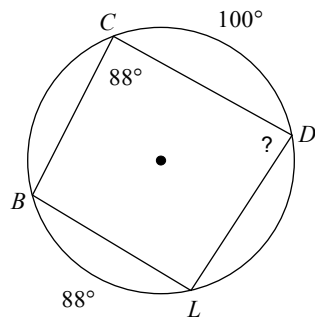

253)

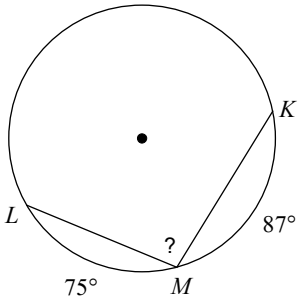

254)

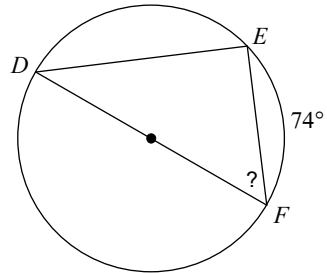

255)

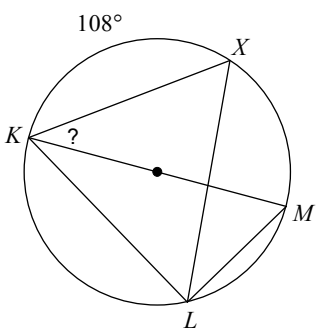

256)

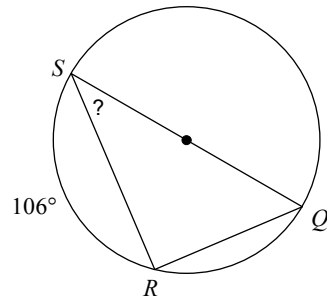

257)

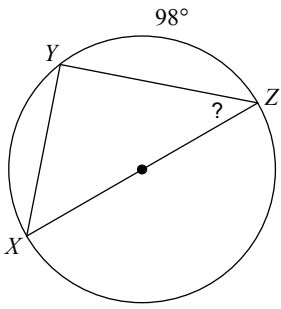

258)

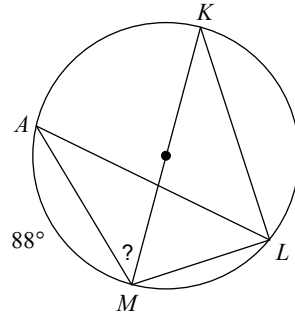

259)

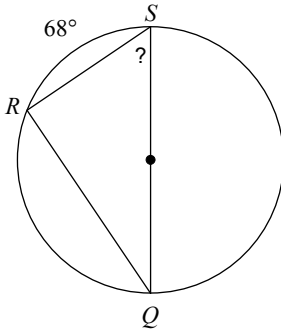

260)

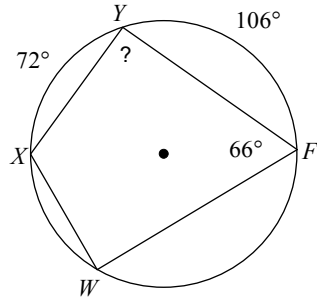

Find the measure of the unknown arc

261) Find $m\widehat{FED}$

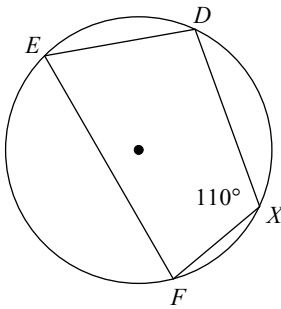

262)

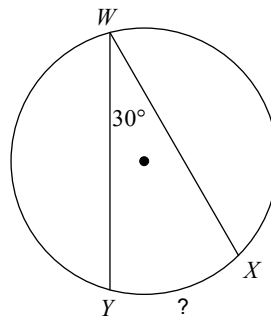

263) Find $m\widehat{SRQ}$

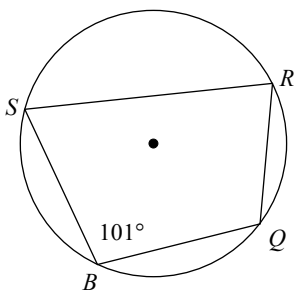

264)

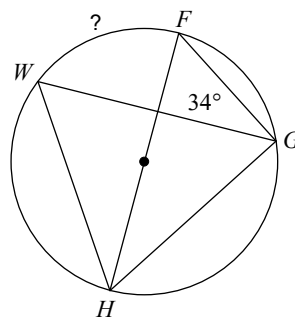

265)

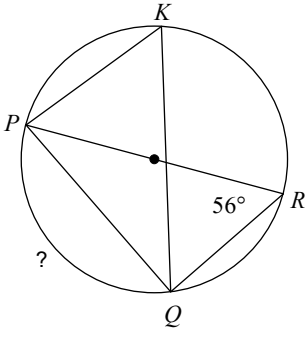

266)

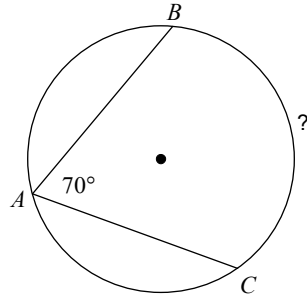

267)

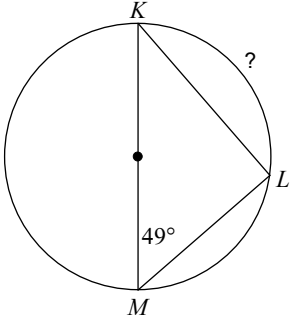

268)

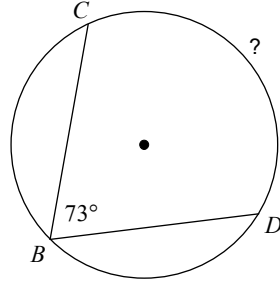

269)

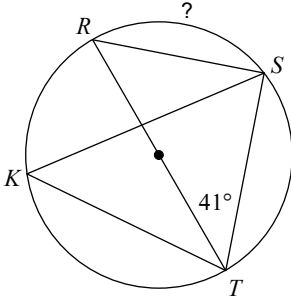

270)

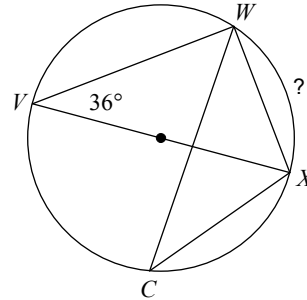

271)

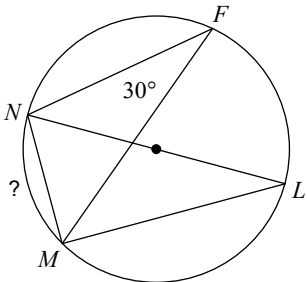

272)

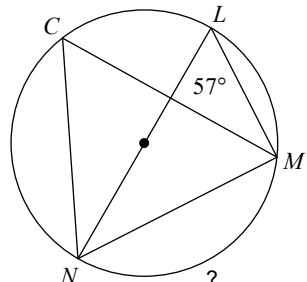

273)

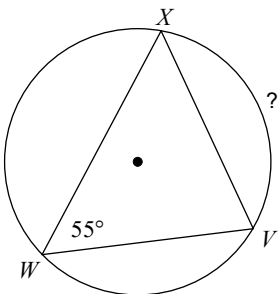

274)

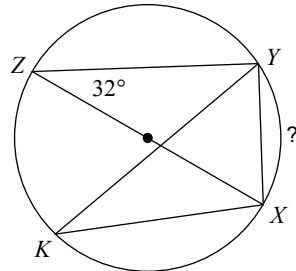

275)

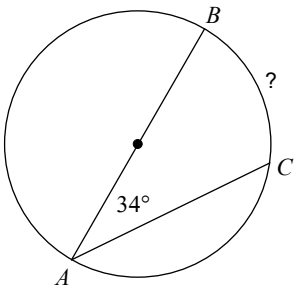

276)

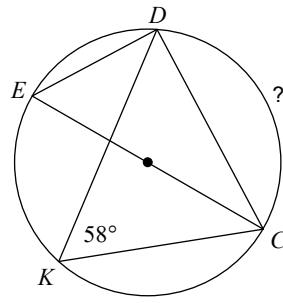

277)

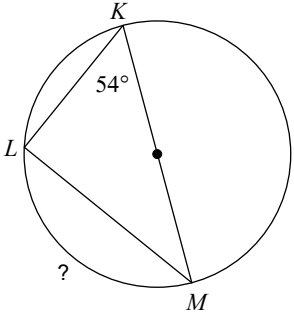

278)

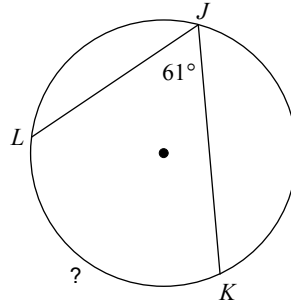

279) Find $m\widehat{LMN}$

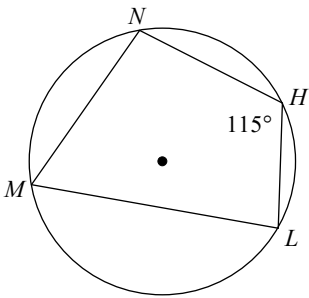

280)

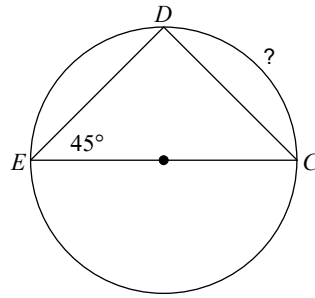

281)

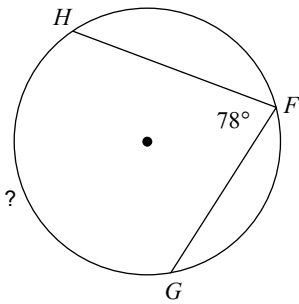

282)

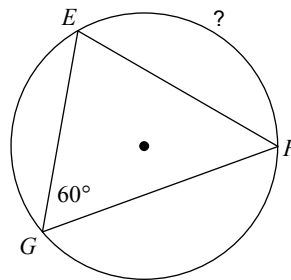

283)

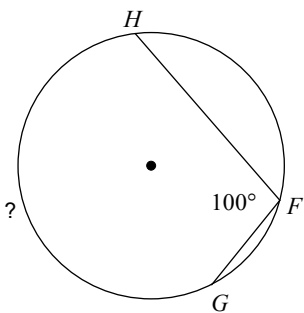

284)

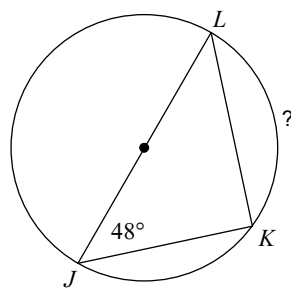

285) Find $m\widehat{CE}$

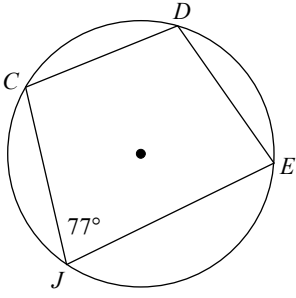

286)

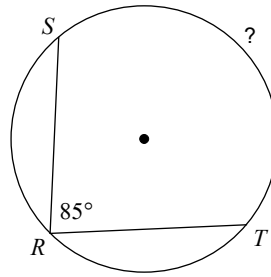

287)

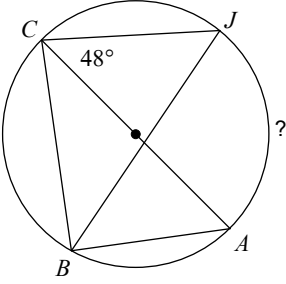

288) Find $m\widehat{EG}$

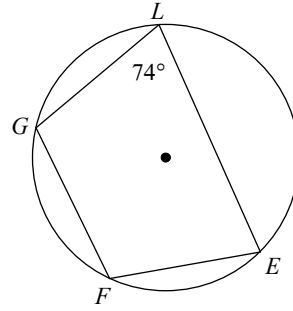

289)

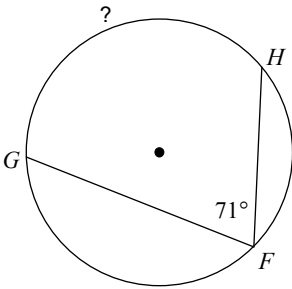

290)

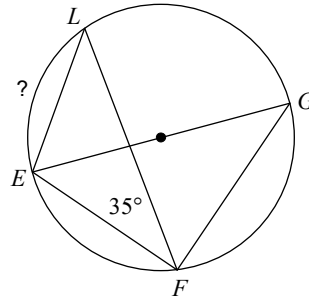

291)

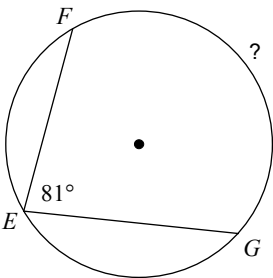

292)

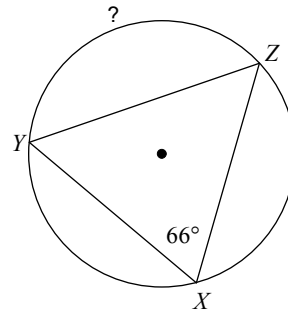

293)

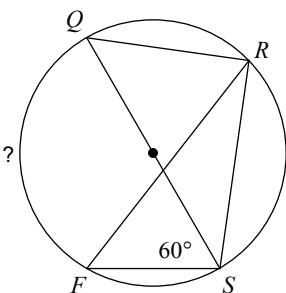

294) Find $m\widehat{YXW}$

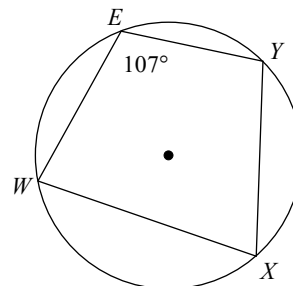

295)

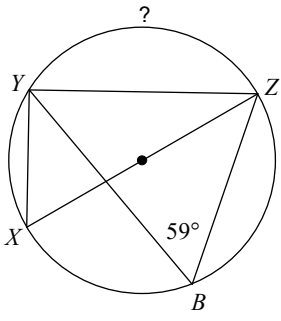

296)

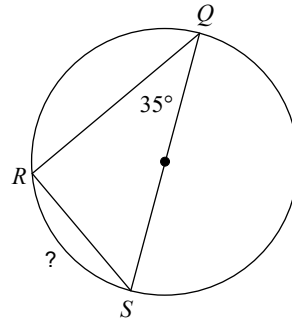

297)

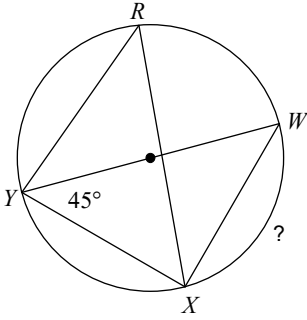

298)

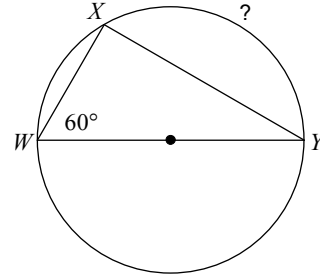

299)

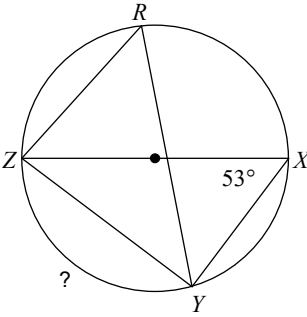

300)

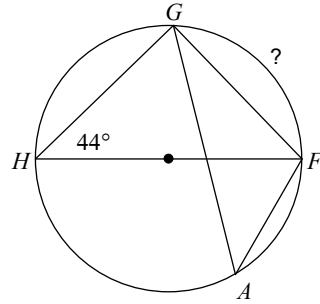

301) Find $m\widehat{QS}$

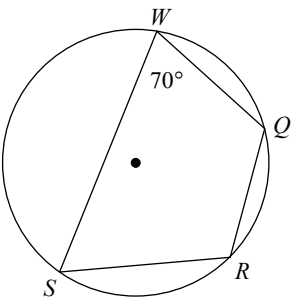

302)

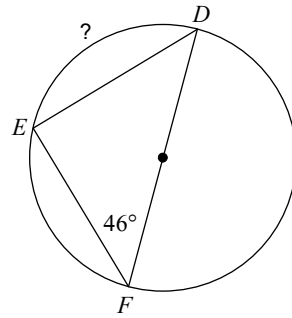

303)

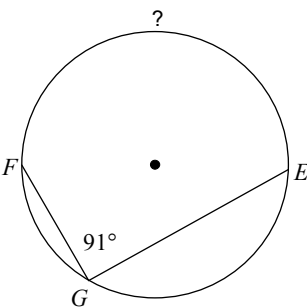

304)

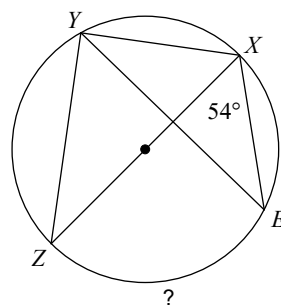

305)

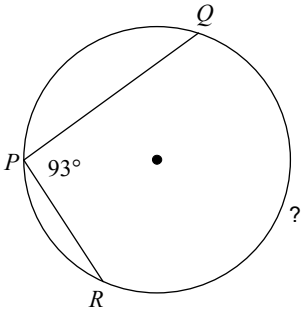

306) Find $m\widehat{KLM}$

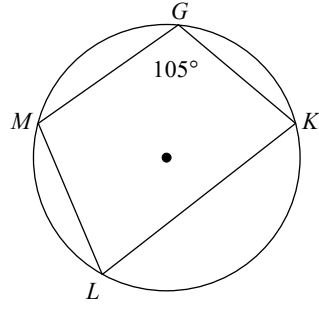

307) Find $m\widehat{KLM}$

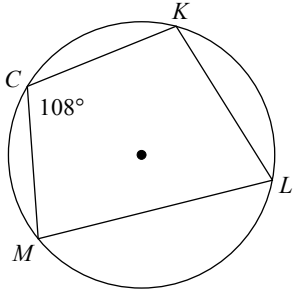

308) Find $m\widehat{JKL}$

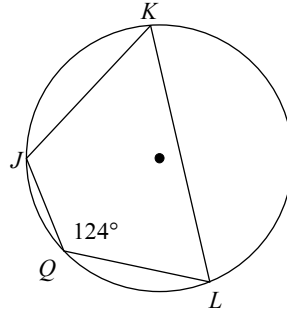

309)

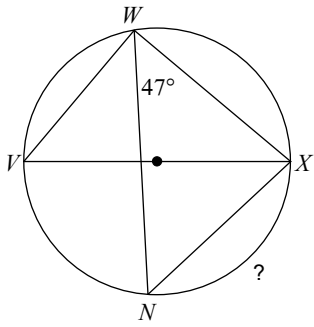

310) Find $m\widehat{EDC}$

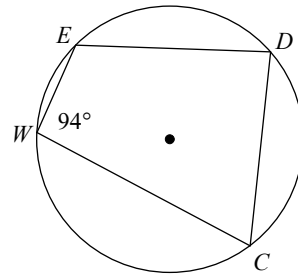

311)

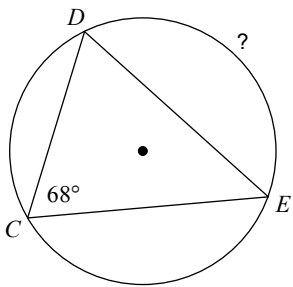

312)

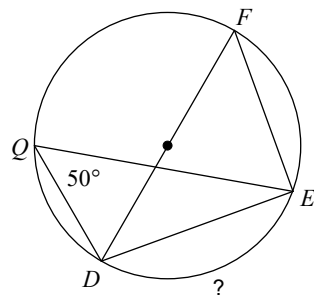

313)

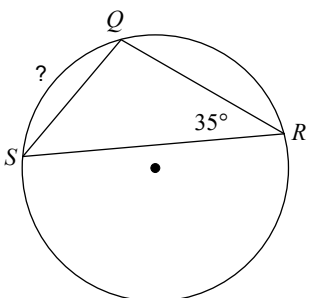

314) Find $m\widehat{LN}$

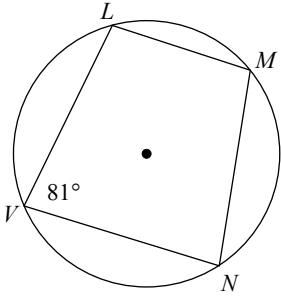

315)

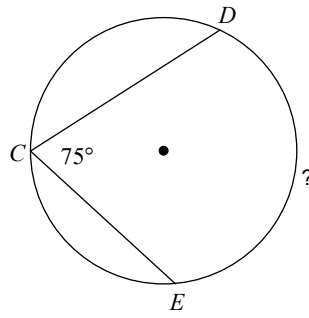

316) Find $m\widehat{PQR}$

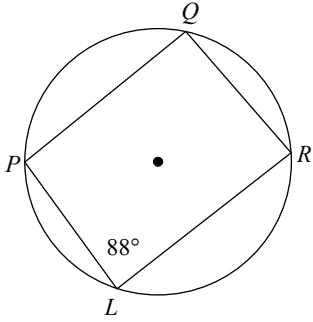

317) Find $m\widehat{DEF}$

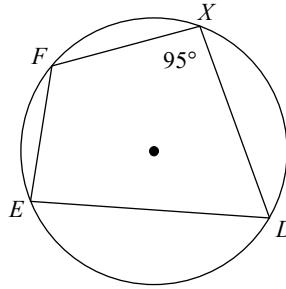

318) Find $m\widehat{PQR}$

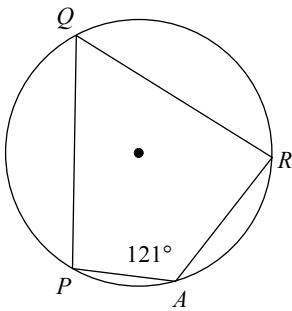

319)

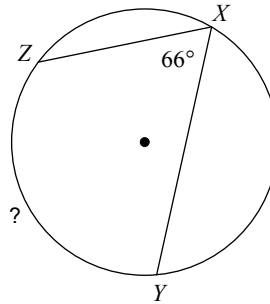

320) Find $m\widehat{VWX}$

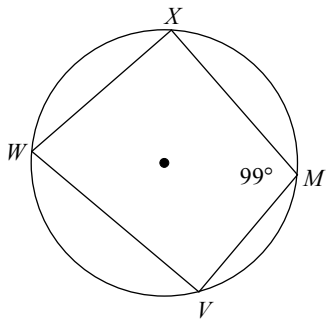

321)

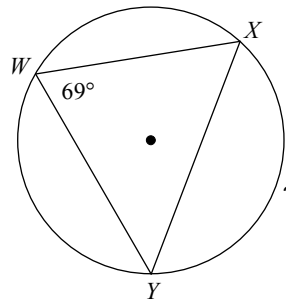

322)

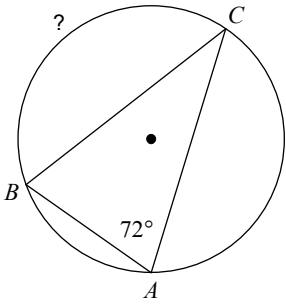

323)

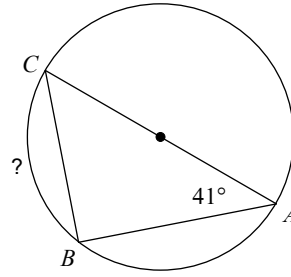

324)

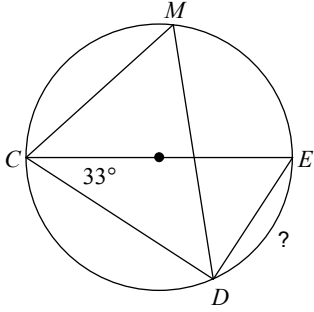

325)

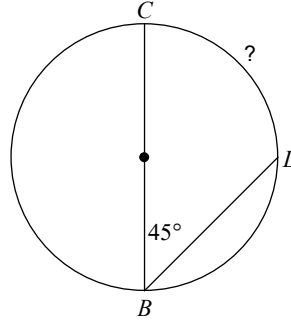

326)

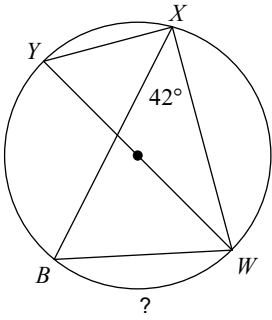

327)

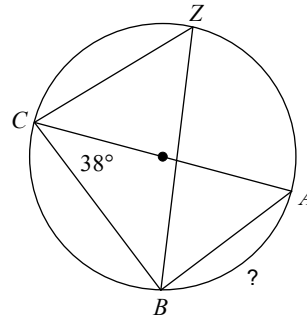

328)

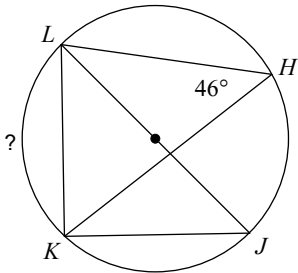

329) Find $m\widehat{YXW}$

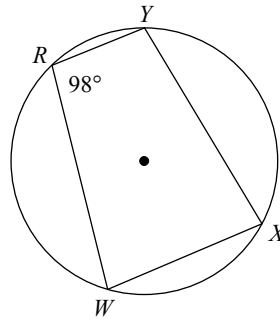

330) Find $m\widehat{BCD}$

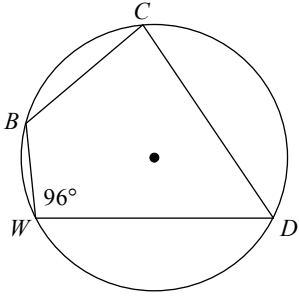

331)

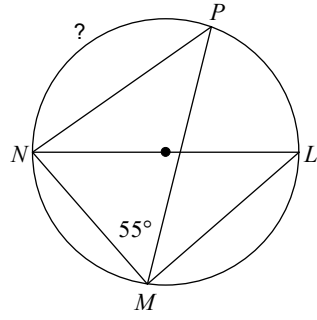

332)

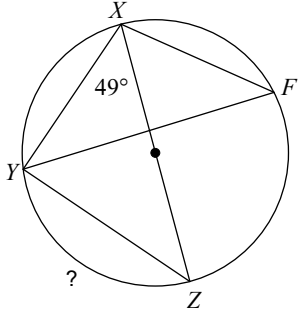

333)

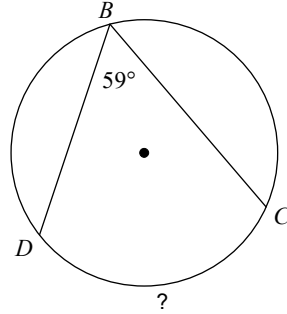

334)

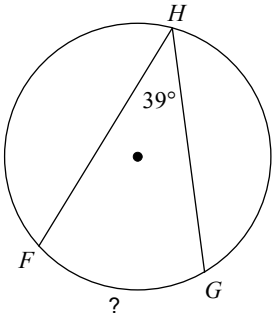

335)

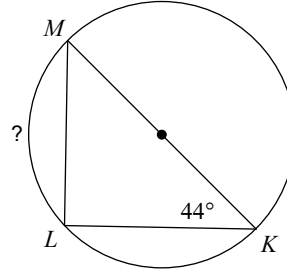

336) Find $m\widehat{BD}$

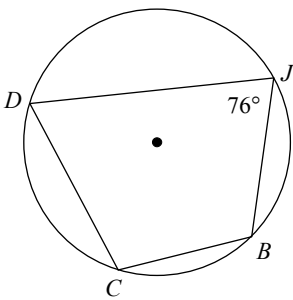

337) Find $m\widehat{XWV}$

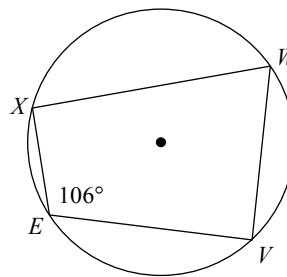

338)

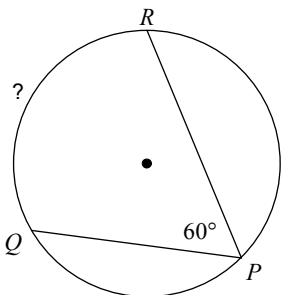

339)

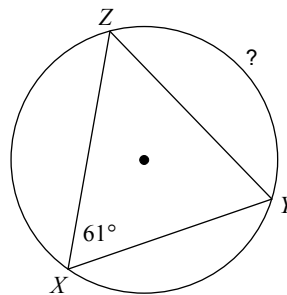

340) Find $m\widehat{ABC}$

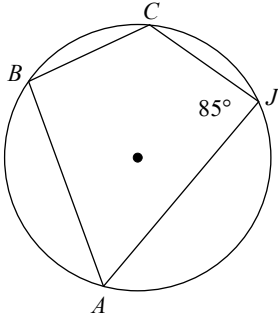

341)

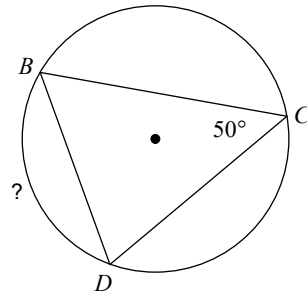

342)

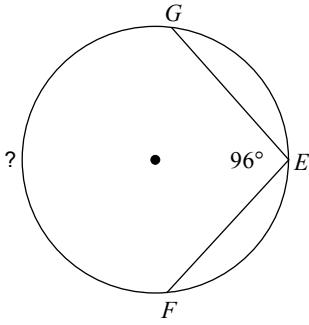

343)

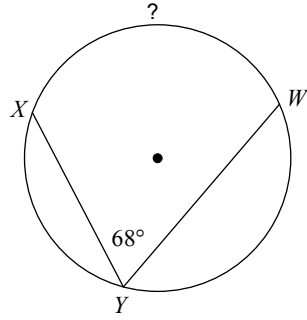

344)

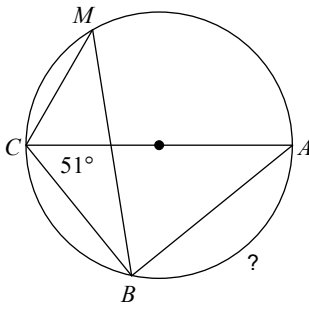

345)

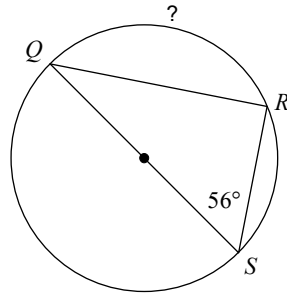

346) Find $m\widehat{WXY}$

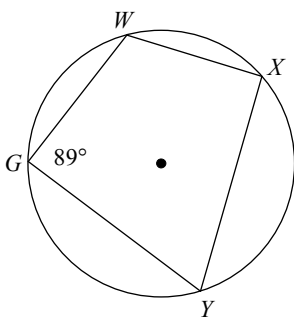

347) Find $m\widehat{RT}$

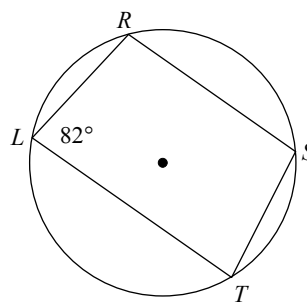

348)

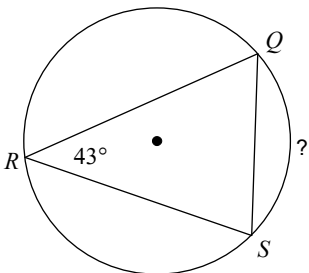

349)

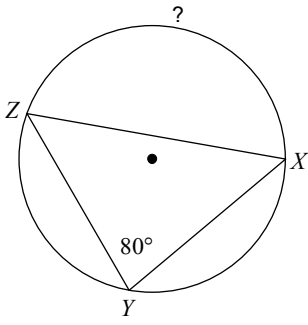

350)

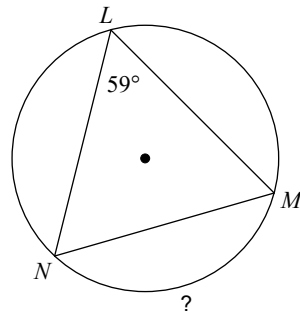

351)

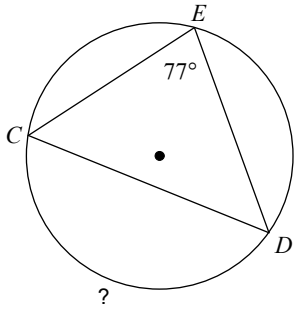

352)

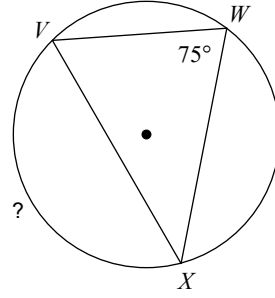

353)

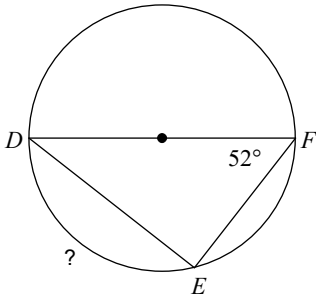

354)

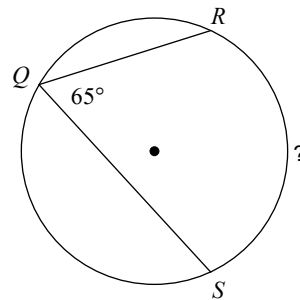

355)

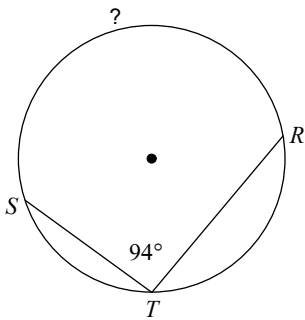

356) Find $m\widehat{KM}$

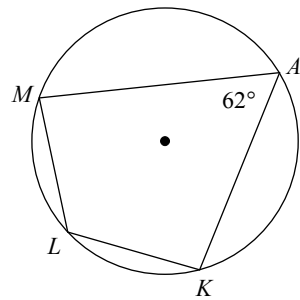

357)

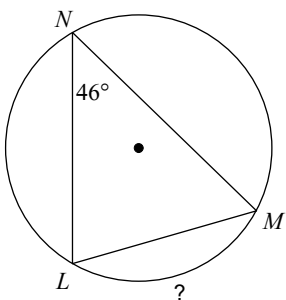

358) Find $m\widehat{SRQ}$

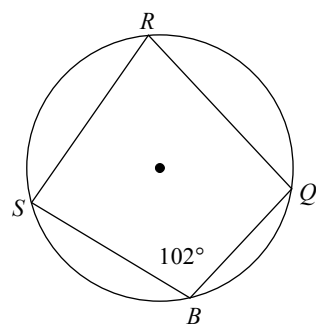

359)

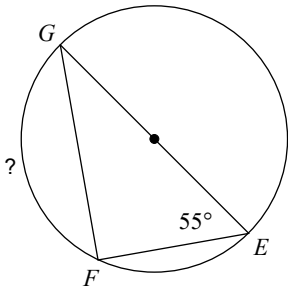

360)

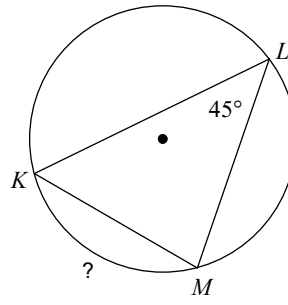

361)

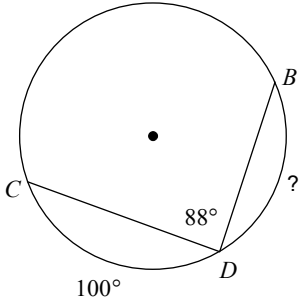

362)

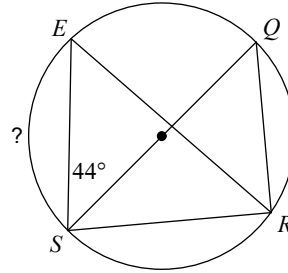

363)

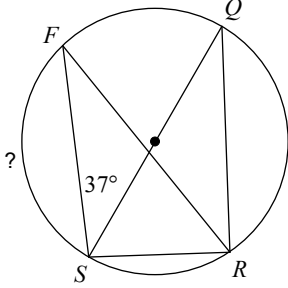

364)

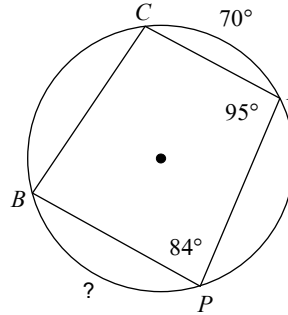

365)

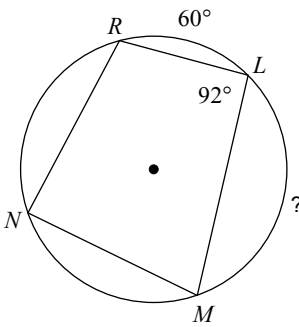

366)

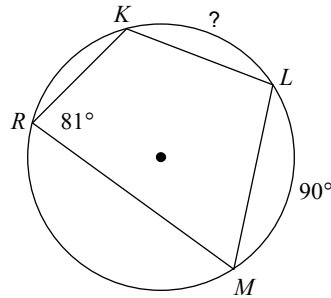

367)

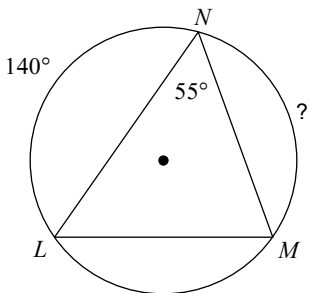

368)

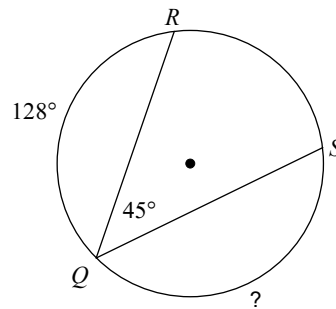

369)

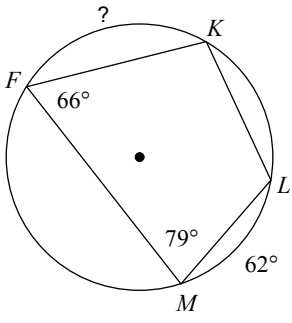

370)

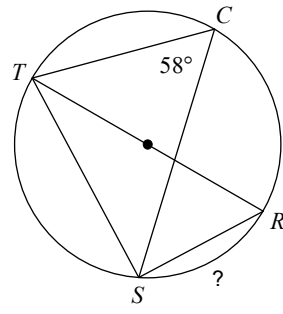

371)

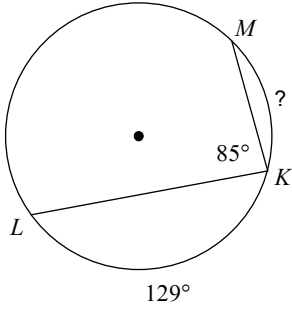

372)

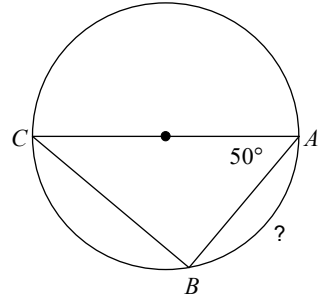

373)

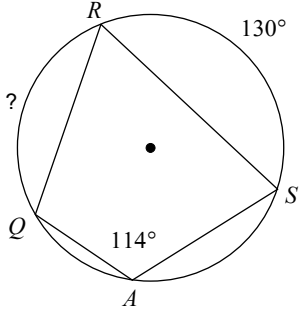

374)

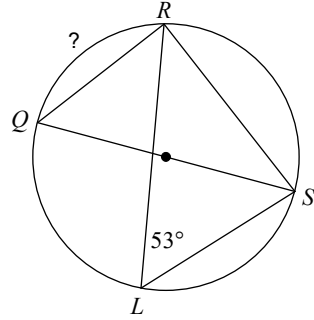

375)

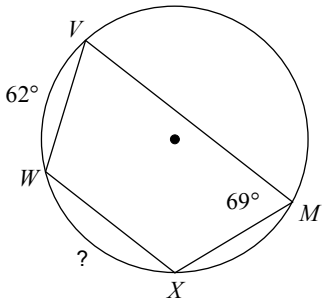

376)

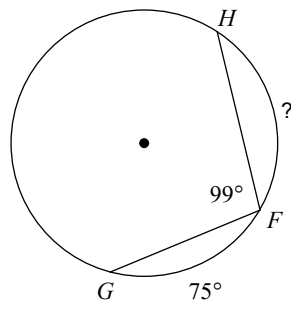

377)

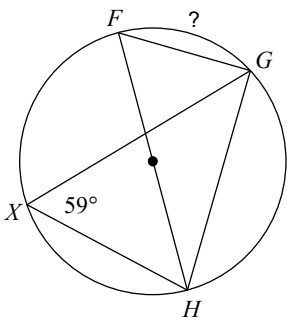

378)

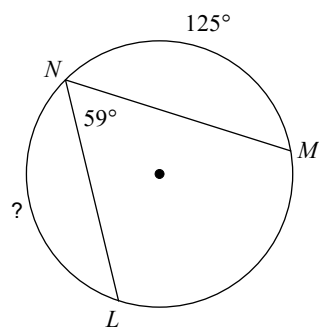

379)

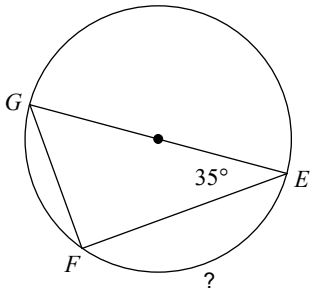

380)

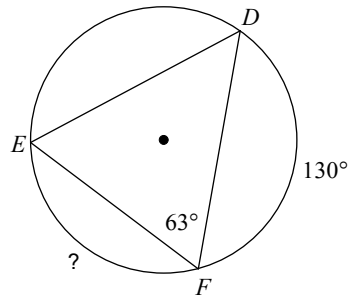

381)

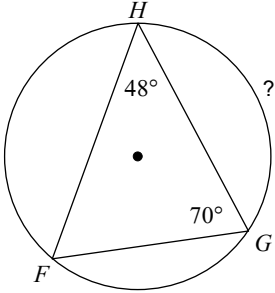

382)

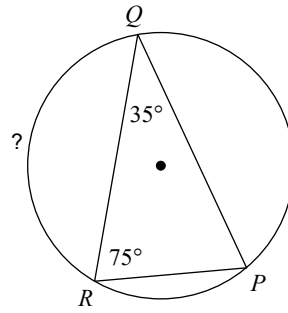

383)

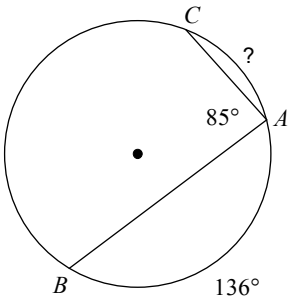

384)

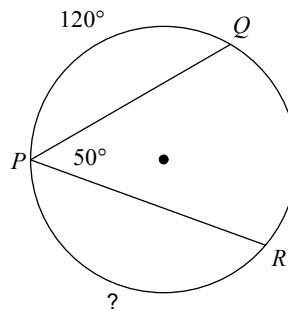

385)

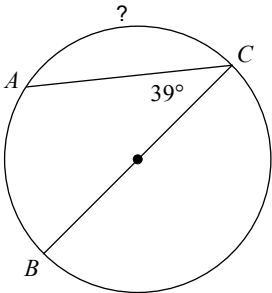

386)

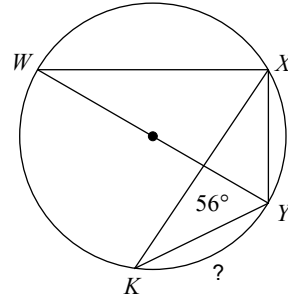

387)

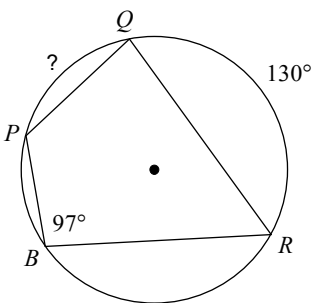

388)

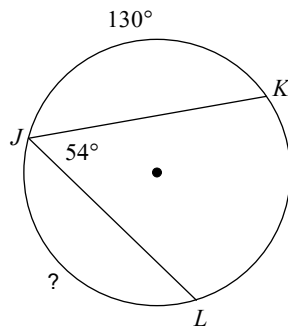

389)

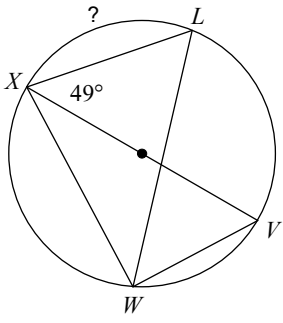

390)

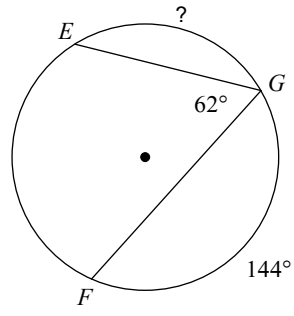

391)

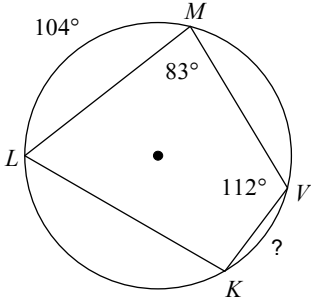

392)

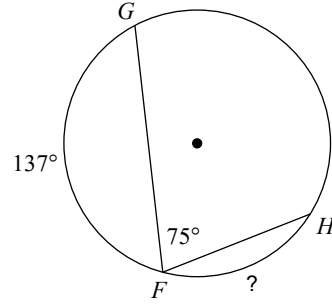

393)

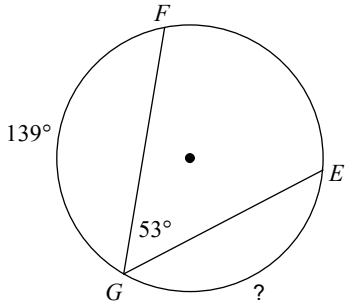

394)

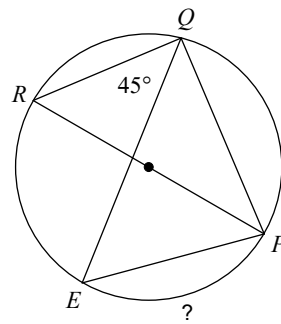

395)

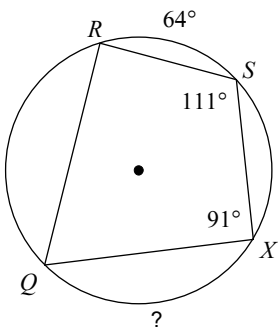

396)

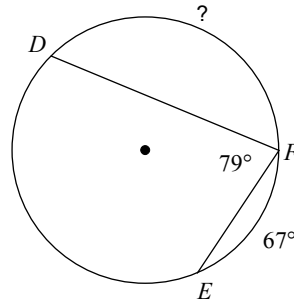

397)

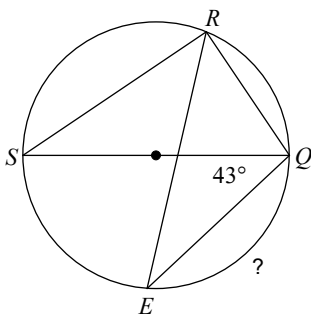

398)

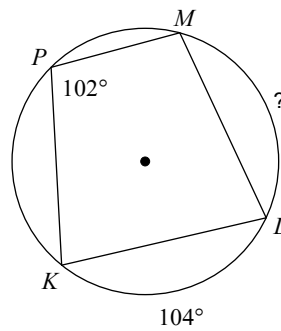

399)

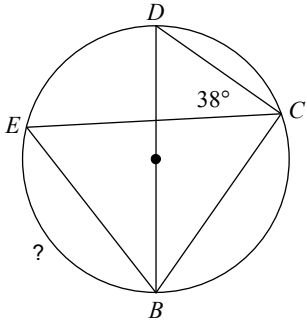

400)

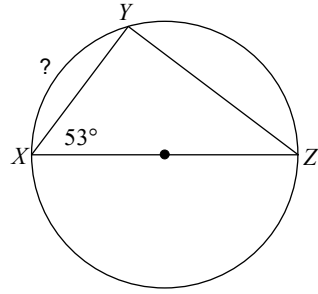

401)

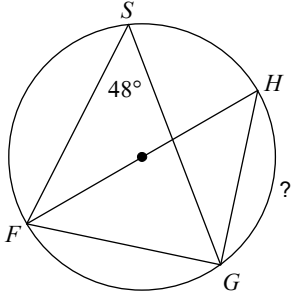

402)

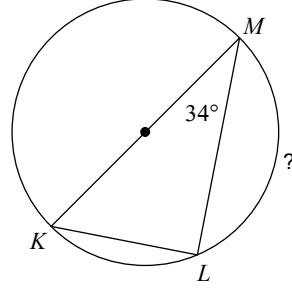

403)

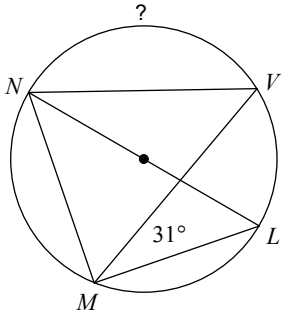

404)

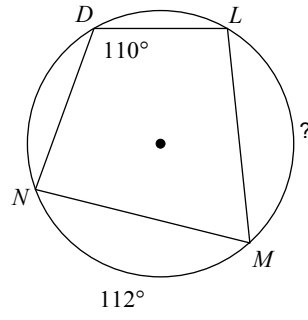

405)

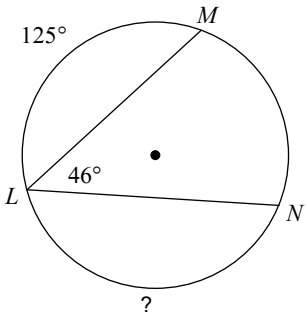

406)

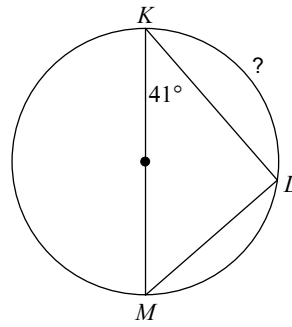

407)

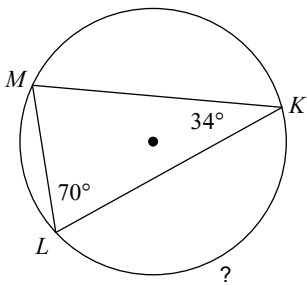

408)

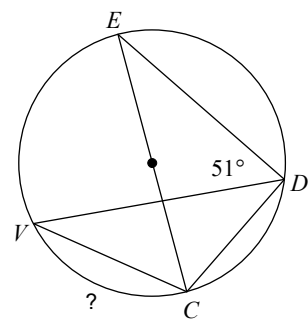

409)

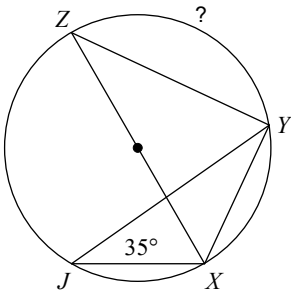

410)

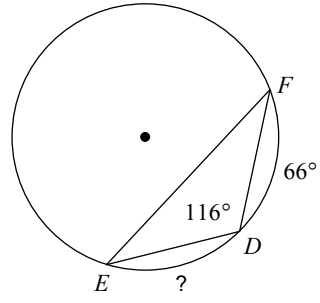

411)

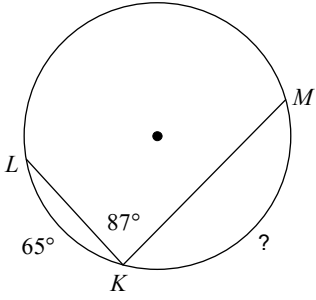

412)

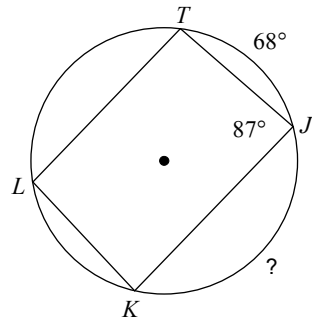

413)

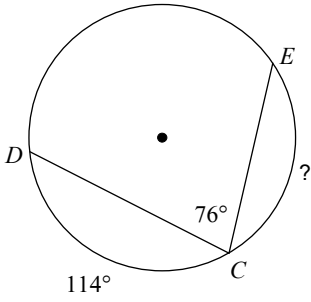

414)

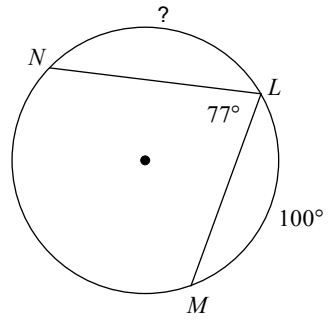

415)

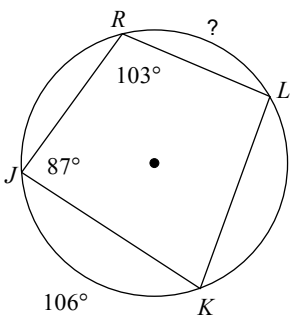

416)

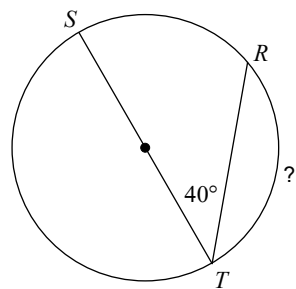

417)

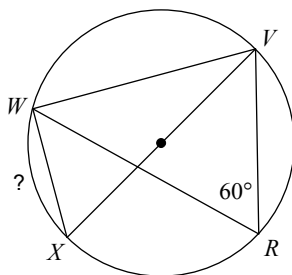

418)

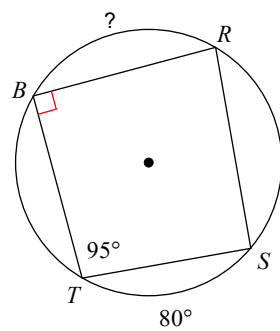

419)

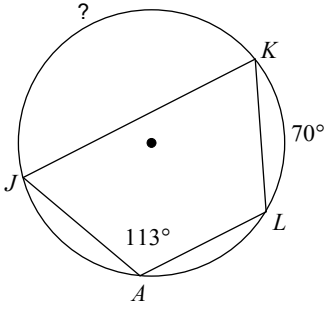

420)

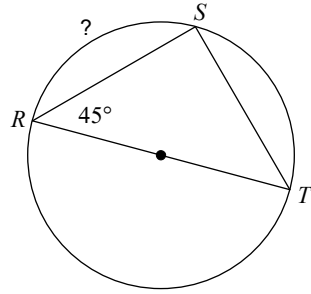

421)

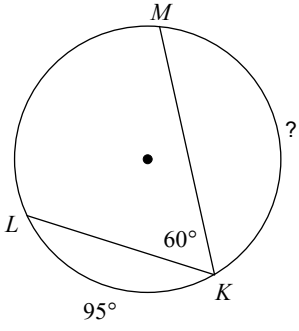

422)

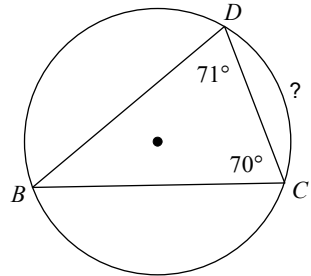

423)

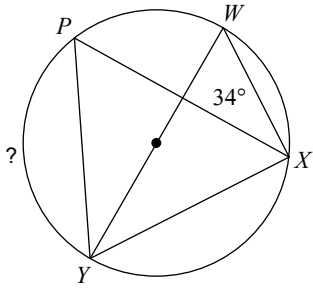

424)

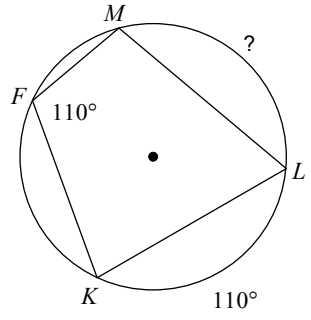

425)

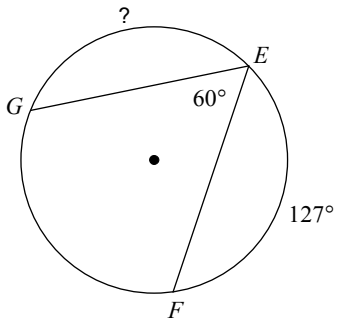

426)

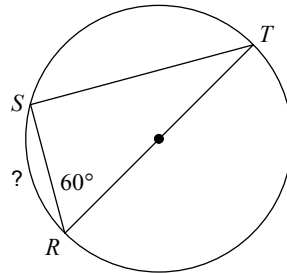

427)

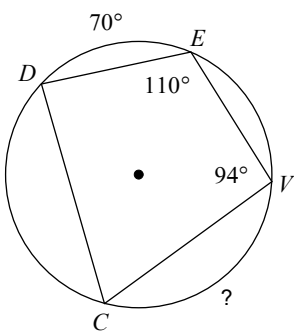

428)

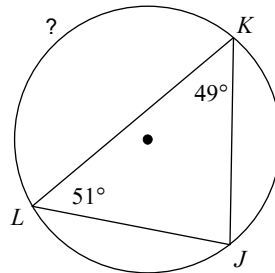

429)

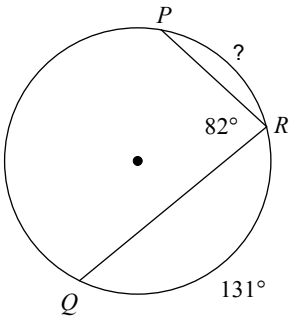

430)

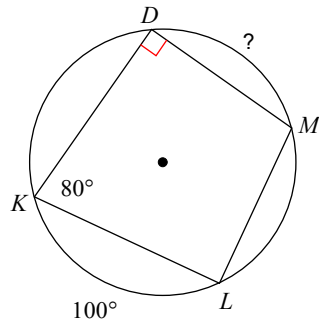

431)

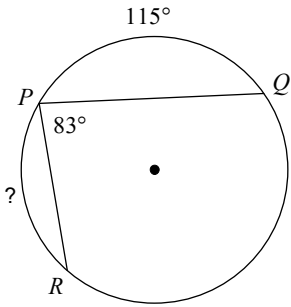

432)

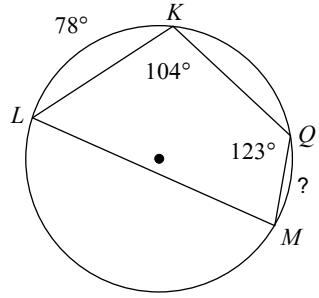

433)

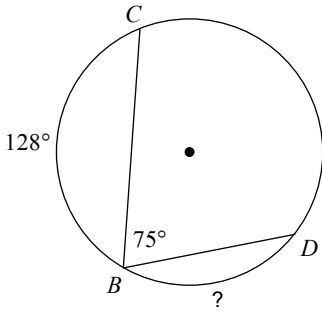

434)

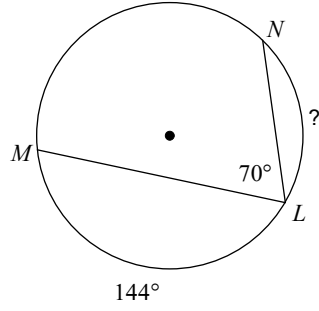

435)

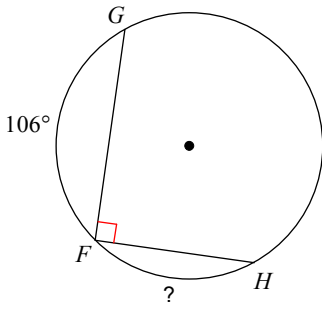

436)

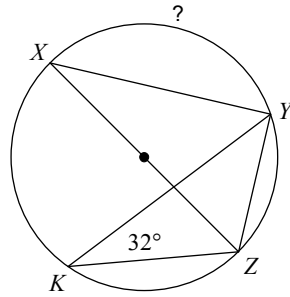

437)

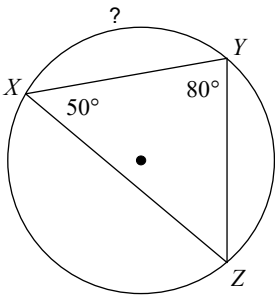

438)

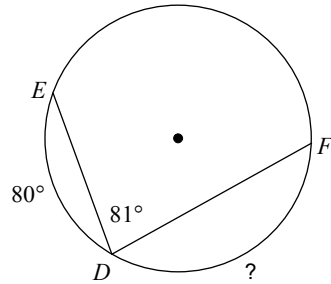

439)

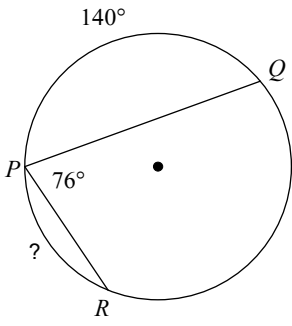

440)

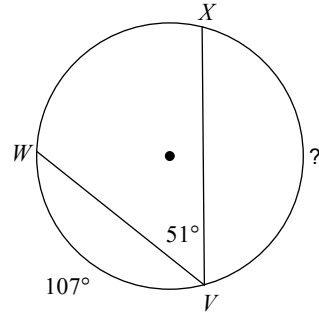

441)

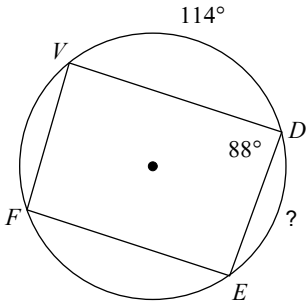

442)

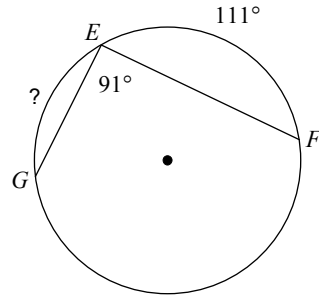

443)

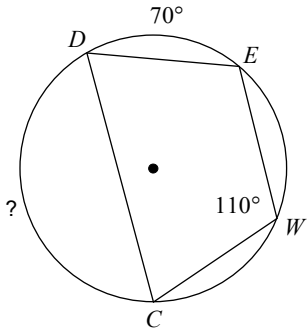

444)

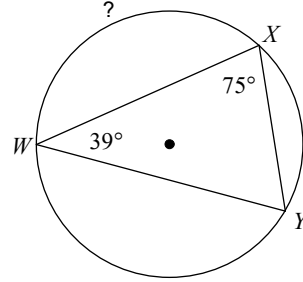

445)

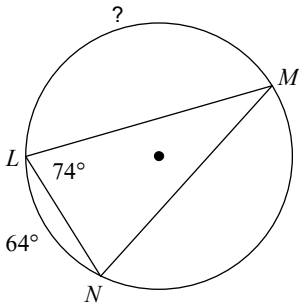

446)

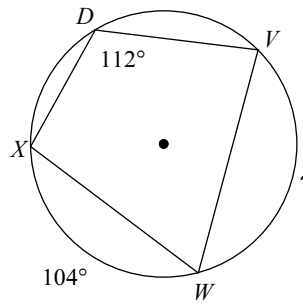

447)

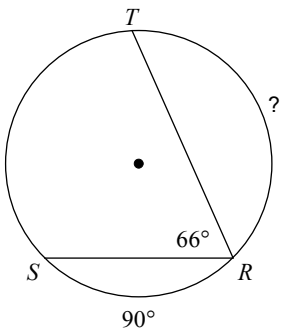

448)

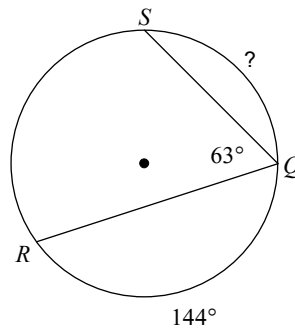

449)

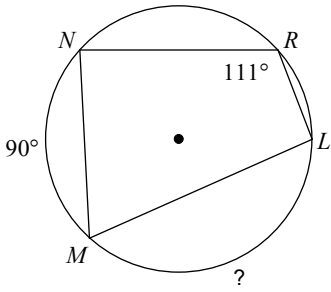

450)

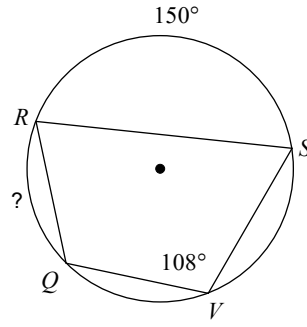

451)

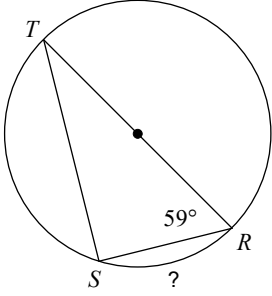

452)

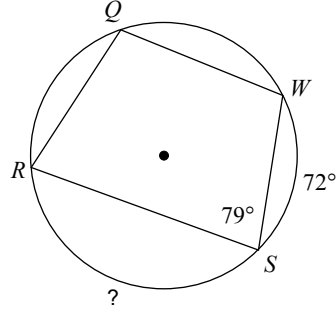

453)

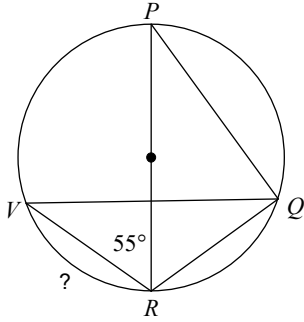

454)

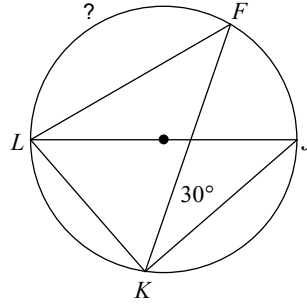

455)

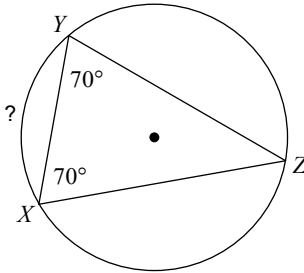

456)

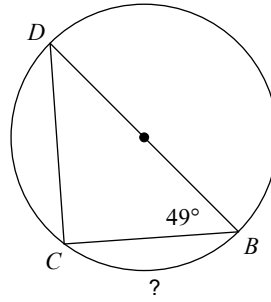

457)

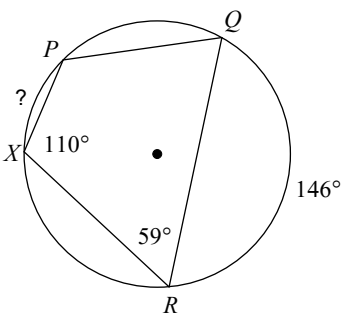

458)

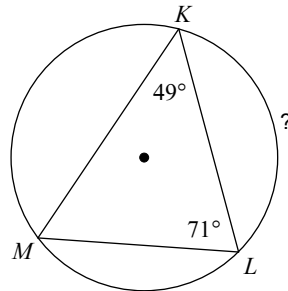

459)

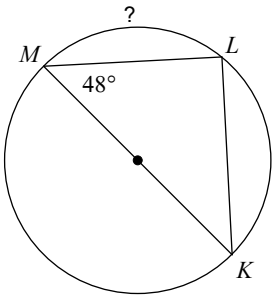

460)

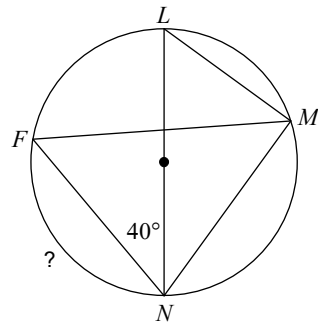

Find the angle measure by solving the unknown

461)

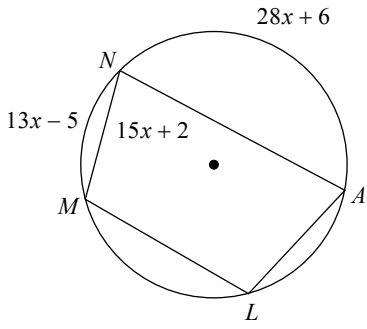

462)

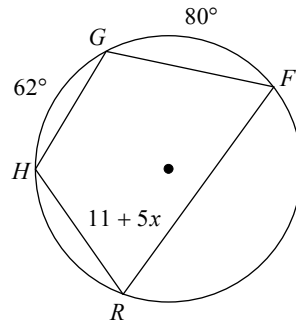

463)

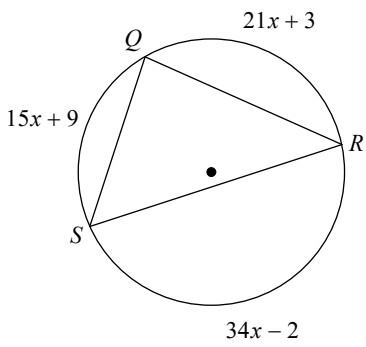

464)

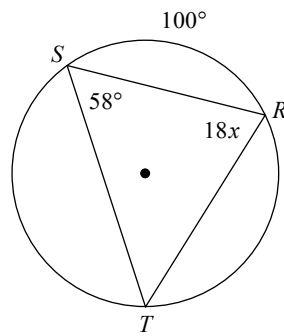

465)

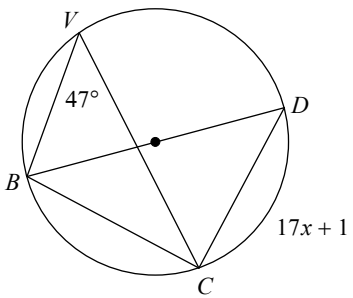

466)

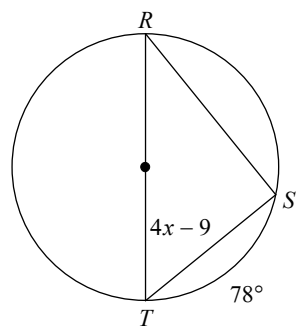

467)

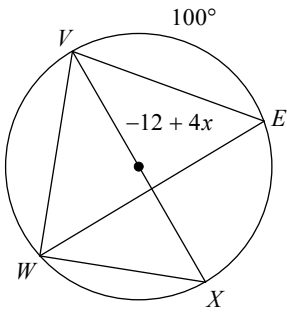

468)

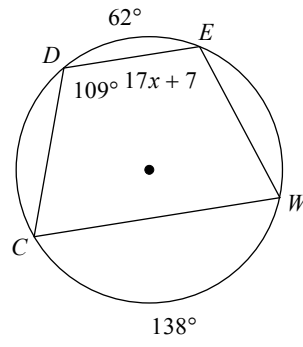

469)

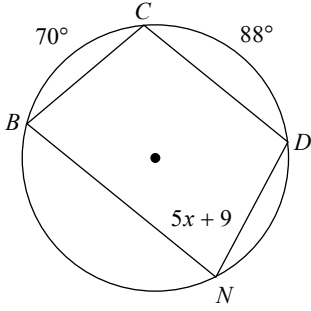

470)

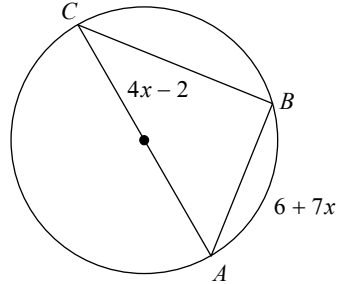

471)

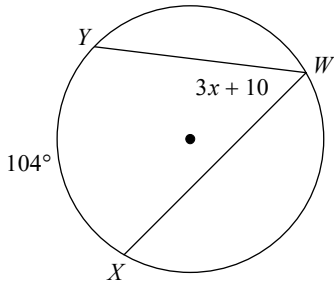

472)

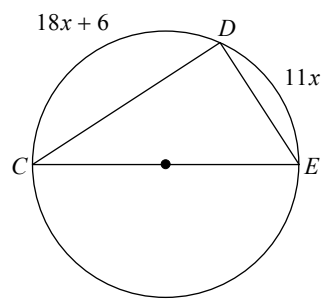

473)

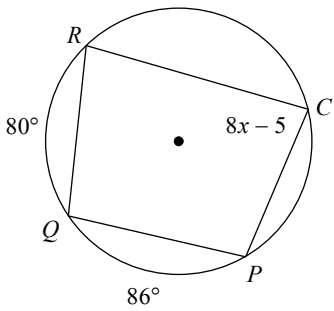

474)

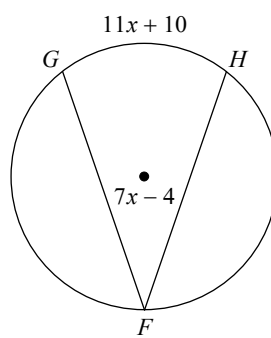

475)

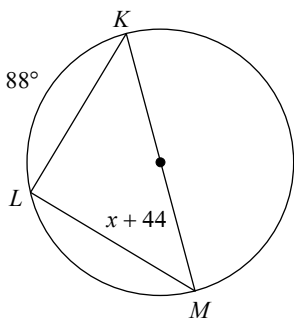

476)

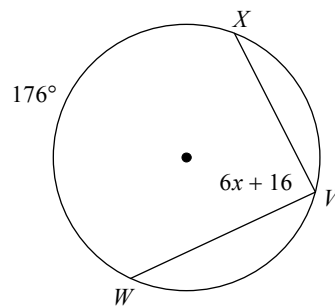

477)

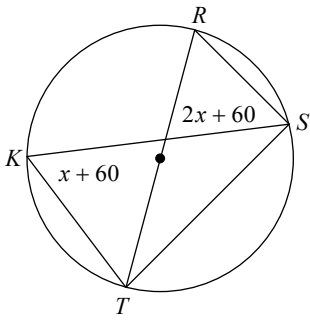

478)

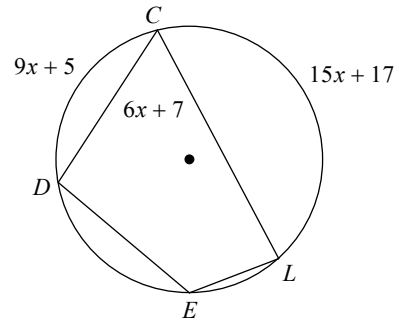

479)

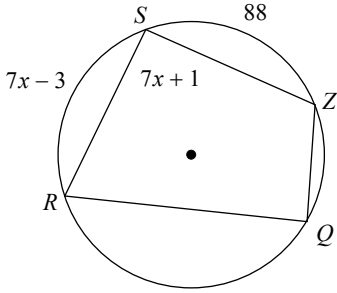

480)

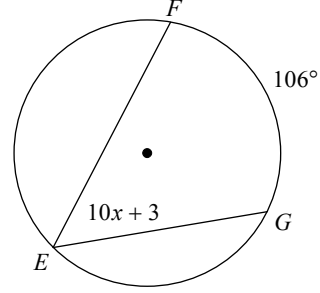

481)

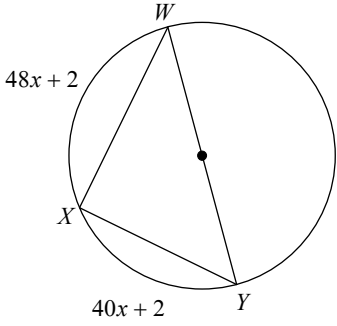

482)

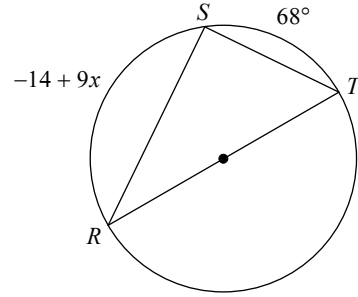

483)

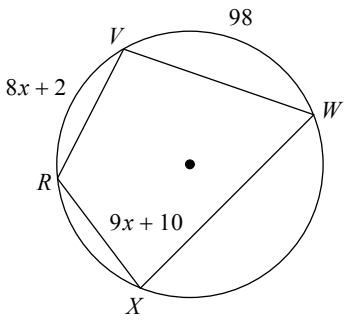

484)

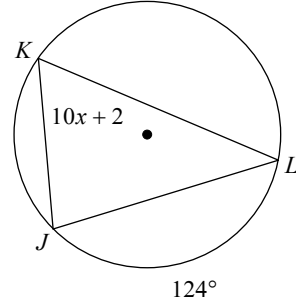

485)

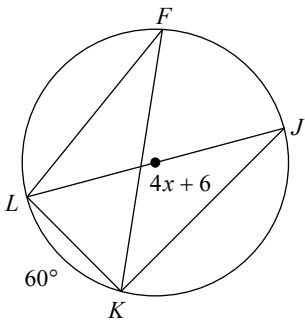

486)

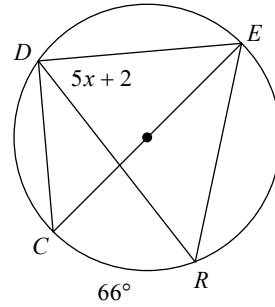

487)

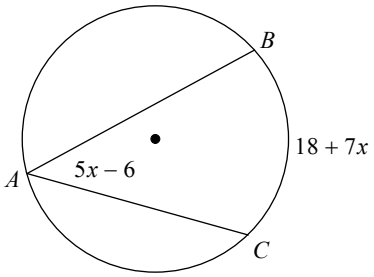

488)

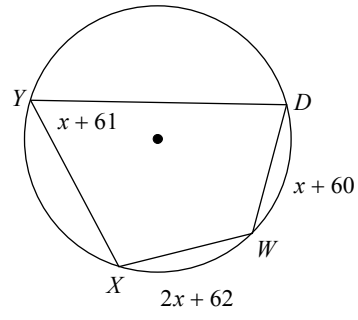

489)

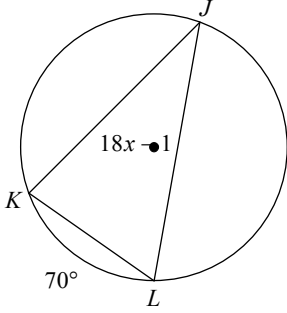

490)

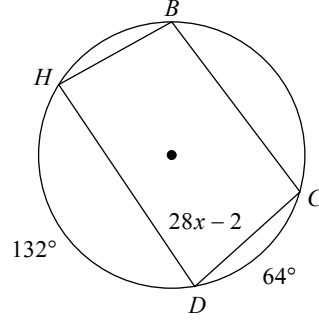

491)

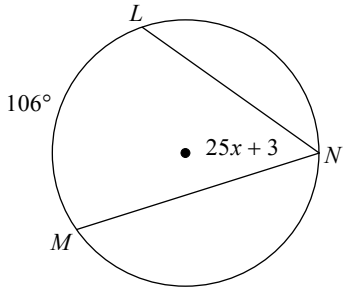

492)

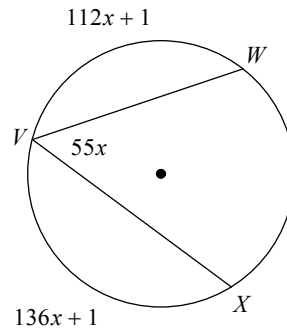

493)

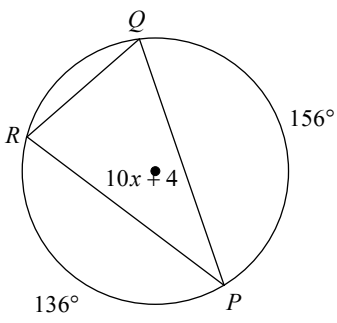

494)

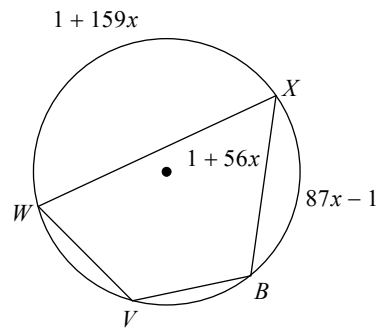

495)

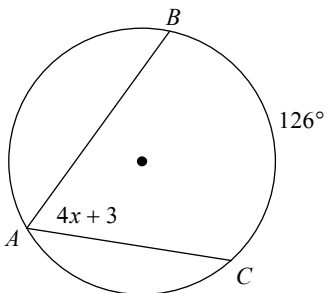

496)

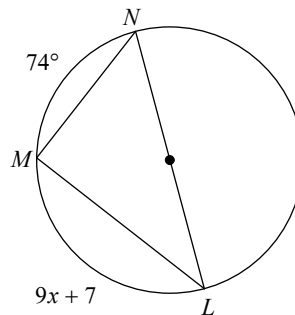

497)

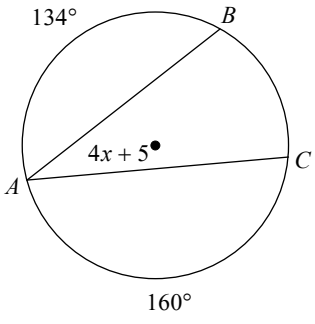

498)

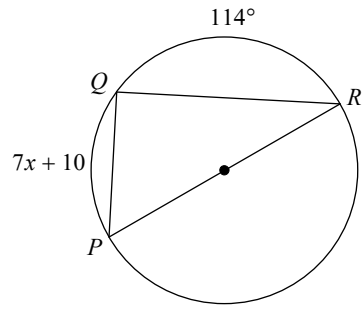

499)

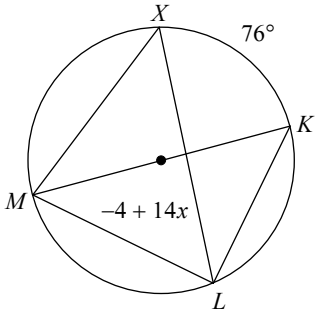

500)

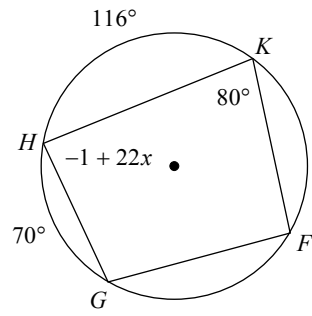

501)

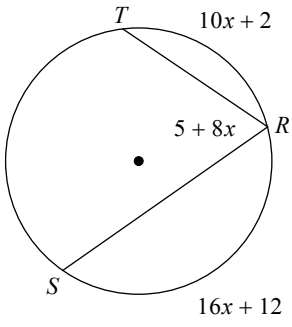

502)

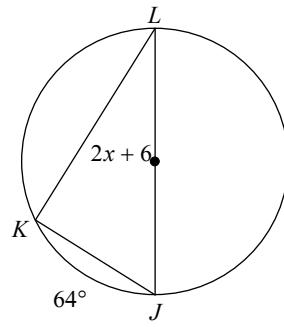

503)

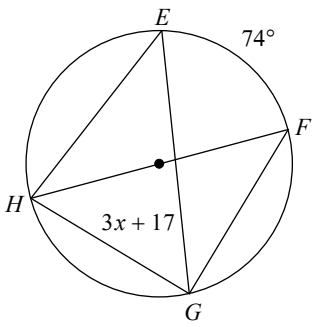

504)

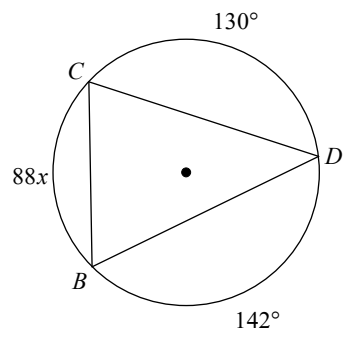

505)

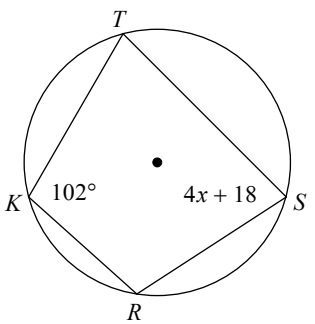

506)

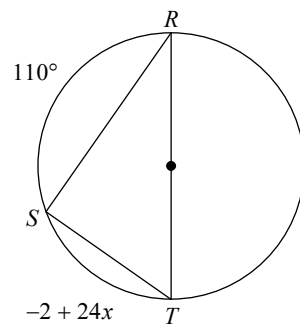

507)

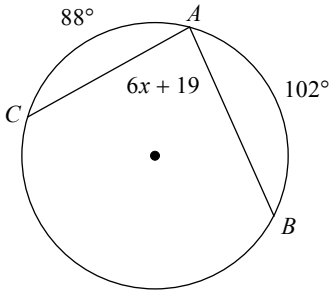

508)

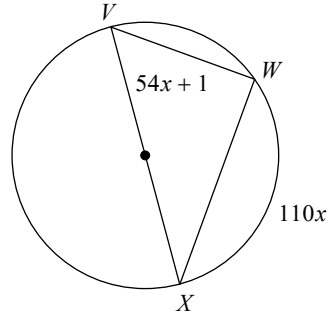

509)

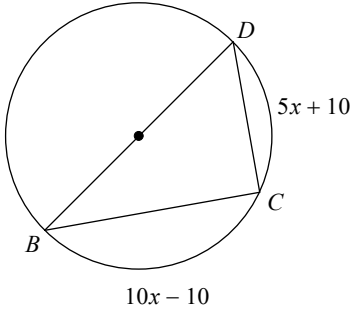

510)

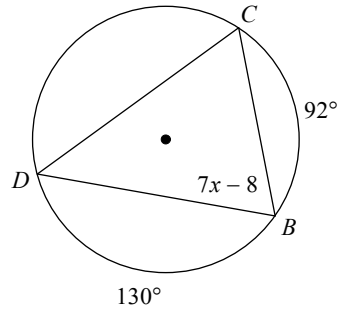

511)

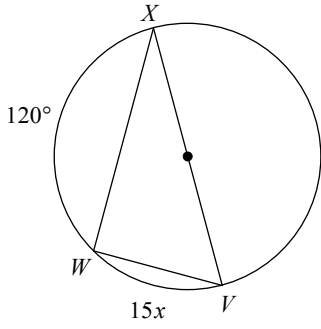

512)

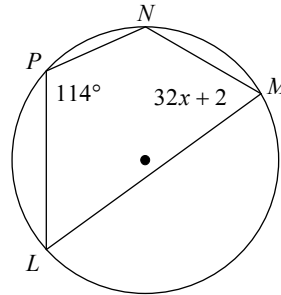

513)

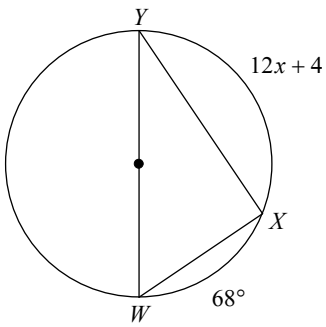

514)

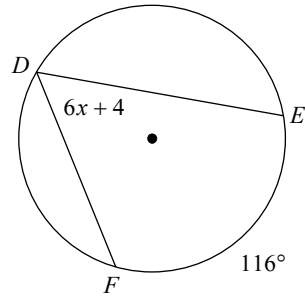

515)

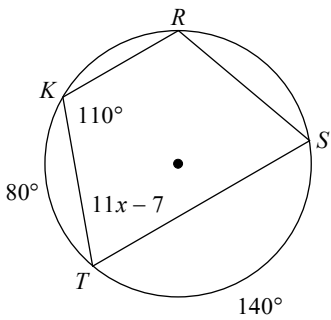

516)

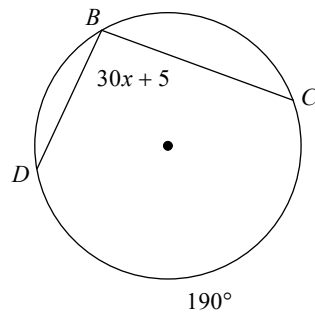

517)

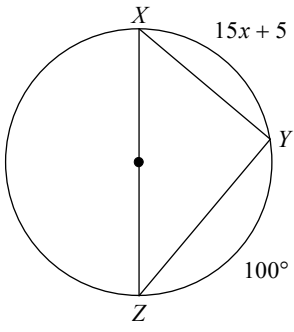

518)

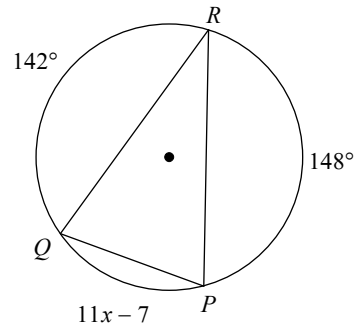

519)

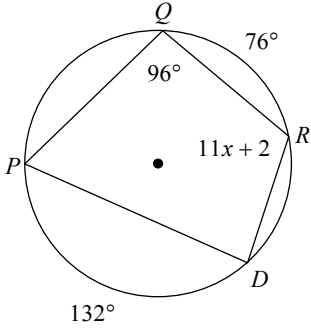

520)

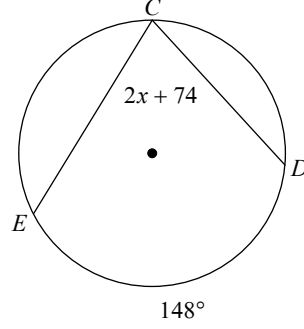

521)

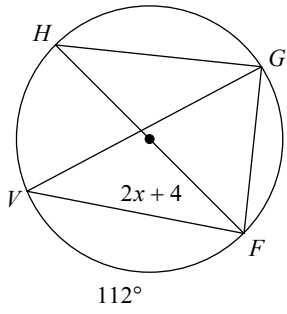

522)

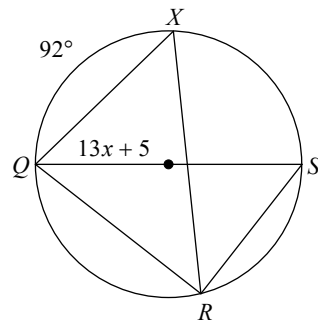

523)

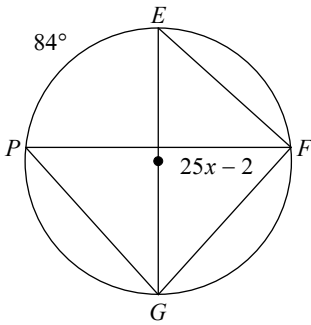

524)

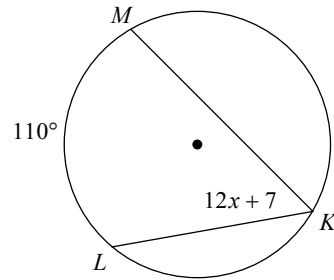

525)

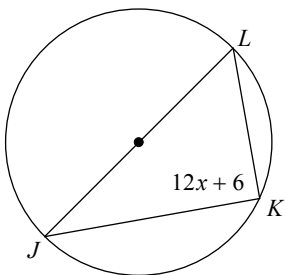

526)

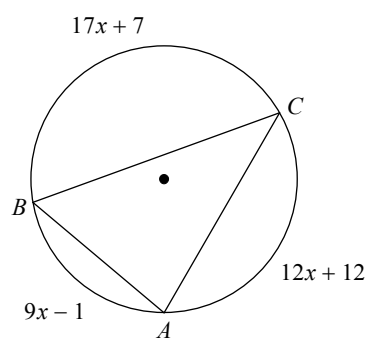

527)

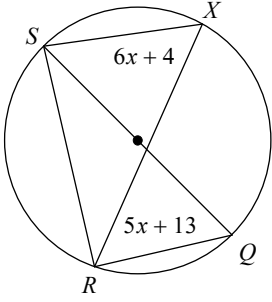

528)

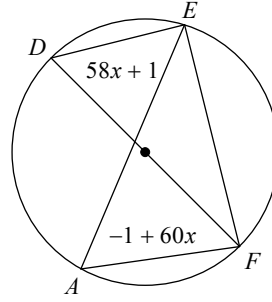

529)

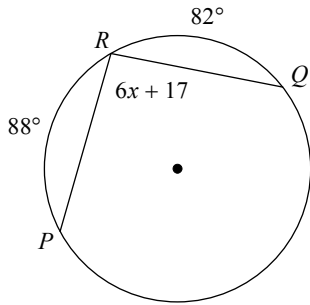

530)

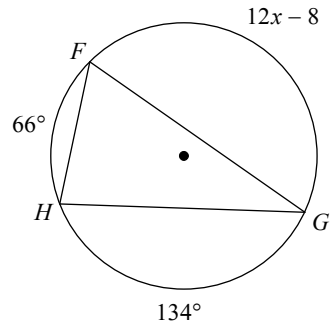

531)

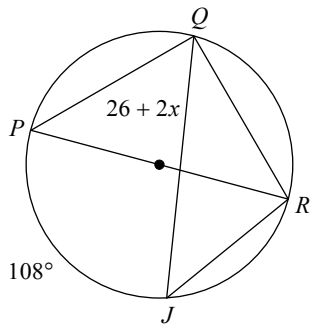

532)

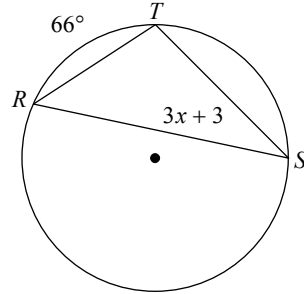

533)

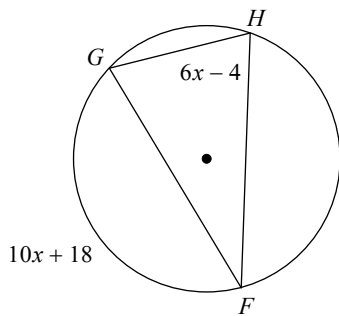

534)

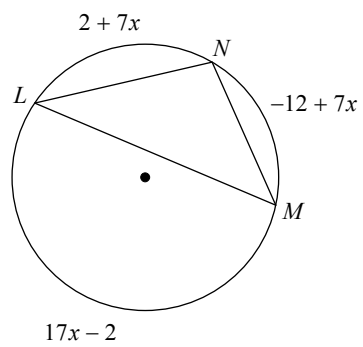

535)

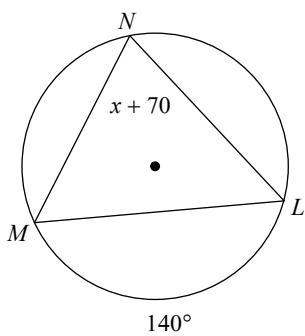

536)

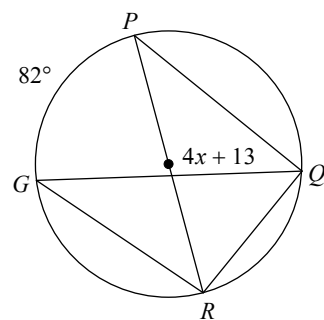

537)

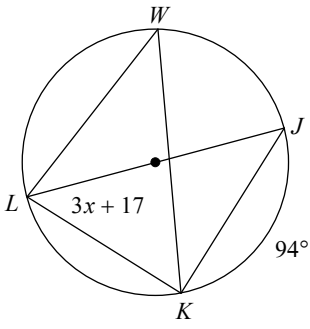

538)

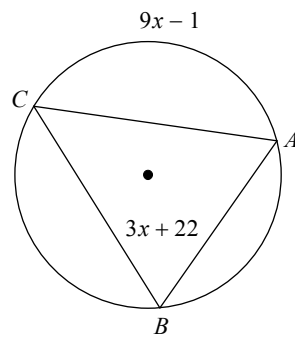

539)

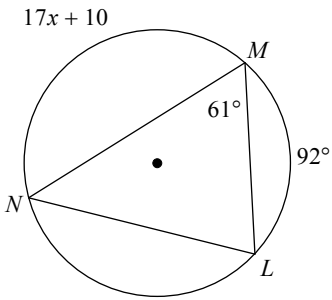

540)

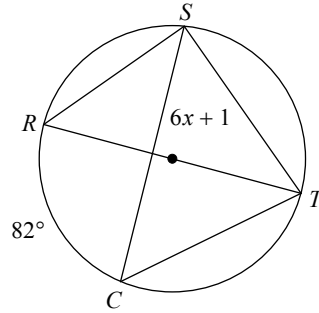

541) Find $m\angle RLK$

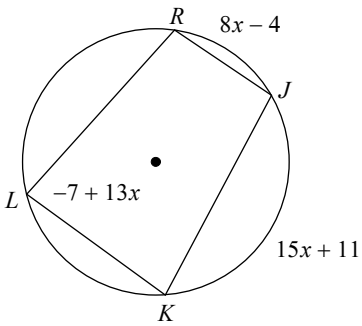

542) Find $m\angle PRQ$

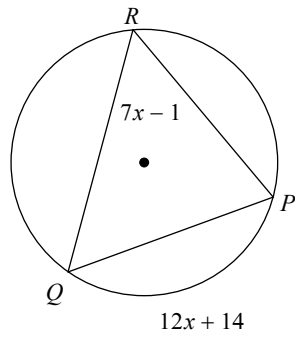

543) Find $m\angle YDW$

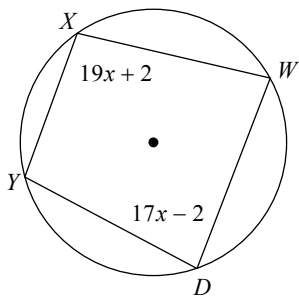

544) Find $m\angle CEA$

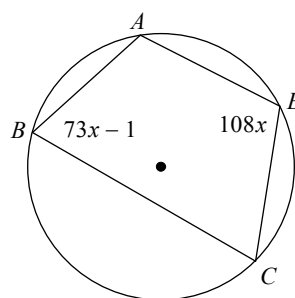

545) Find $m\angle FSG$

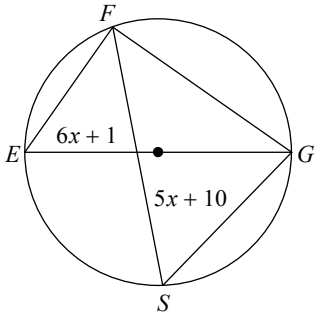

546) Find $m\angle DBC$

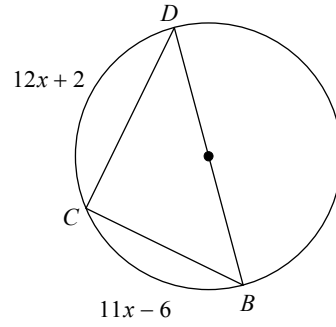

547) Find $m\angle BLM$

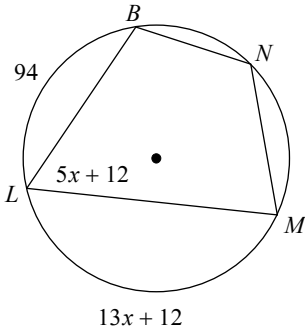

548) Find $m\angle MCN$

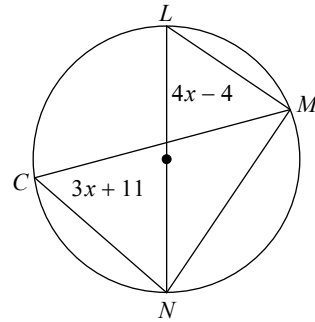

549) Find $m\angle CBD$

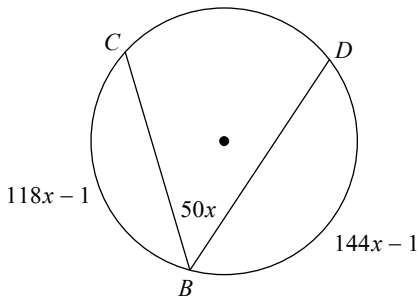

550) Find $m\angle EFD$

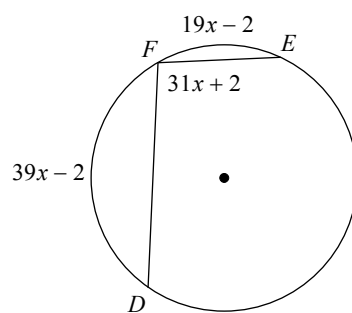

551) Find $m\angle VXW$

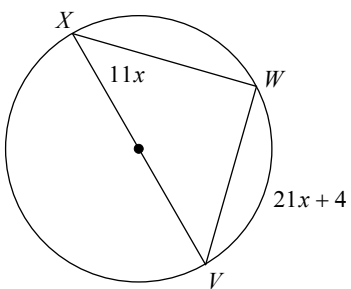

552) Find $m\angle CAB$

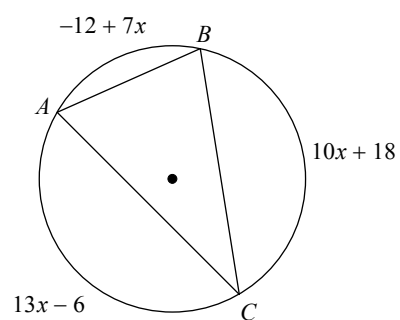

553) Find $m\angle RYQ$

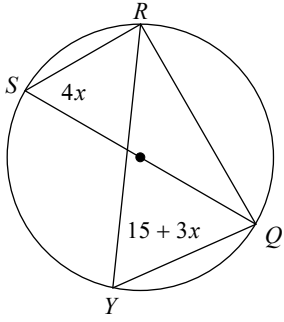

554) Find $m\angle KBM$

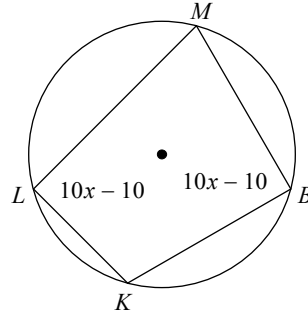

555) Find $m\angle DEC$

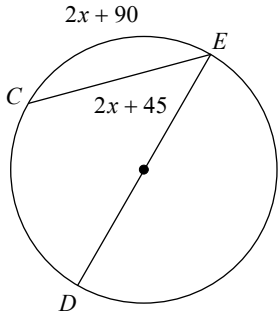

556) Find $m\angle CAB$

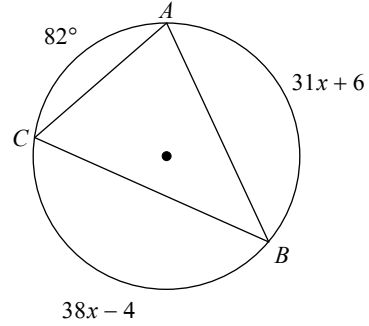

557) Find $m\angle KML$

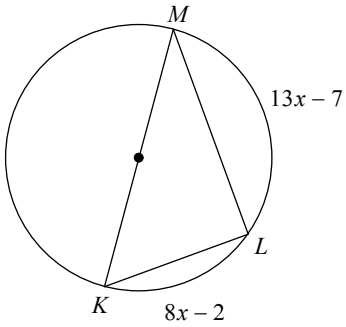

558) Find $m\angle PNM$

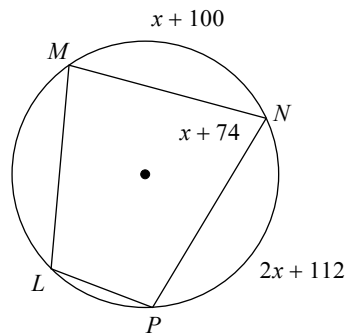

559) Find $m\angle ABC$

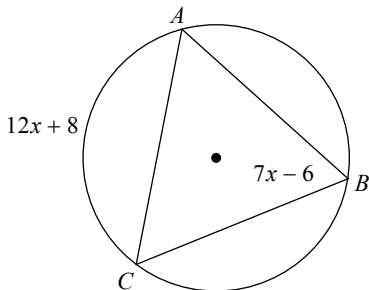

560) Find $m\angle RQS$

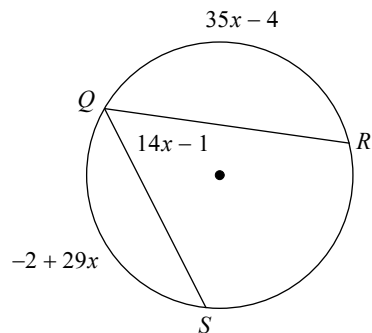

561) Find $m\angle ZTS$

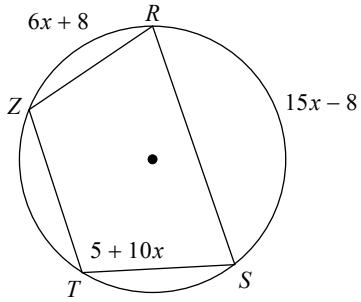

562) Find $m\angle VWX$

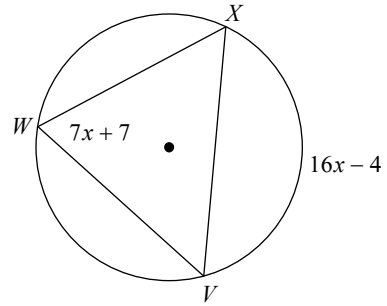

563) Find $m\angle QPR$

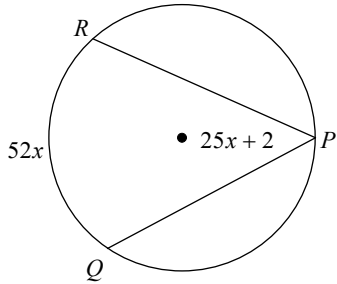

564) Find $m\angle QPR$

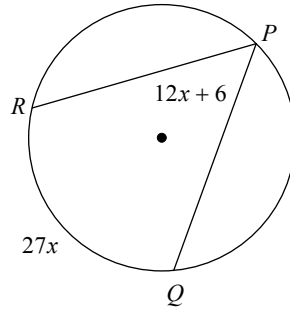

565) Find $m\angle XVW$

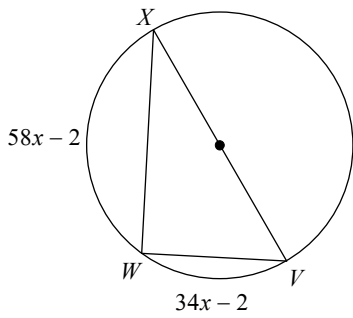

566) Find $m\angle XYW$

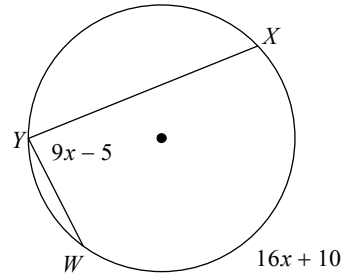

567) Find $m\angle RQS$

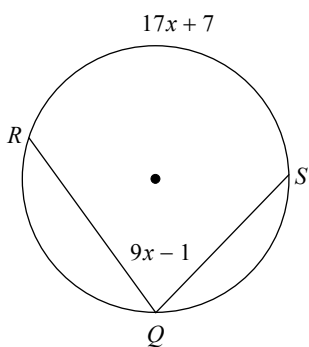

568) Find $m\angle CED$

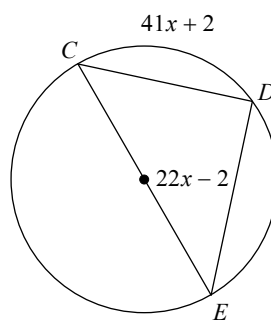

569) Find $m\angle LNM$

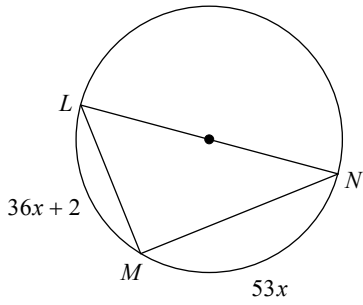

570) Find $m\angle GDC$

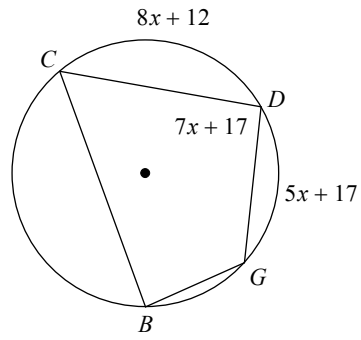

571) Find $m\angle MNL$

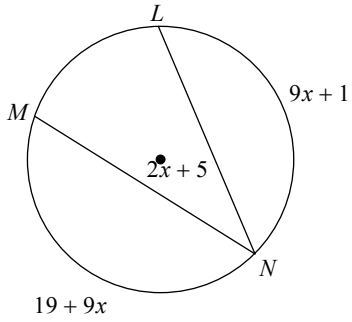

572) Find $m\angle SRT$

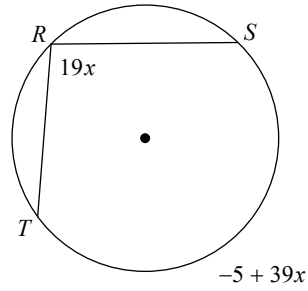

573) Find $m\angle DRQ$

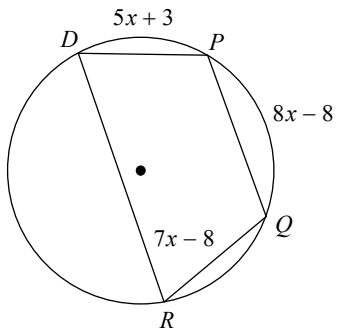

574) Find $m\angle FEG$

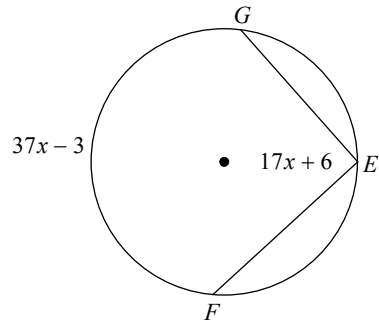

575) Find $m\angle BAC$

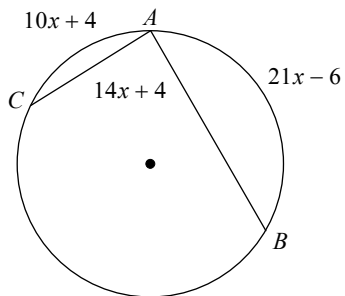

576) Find $m\angle SQR$

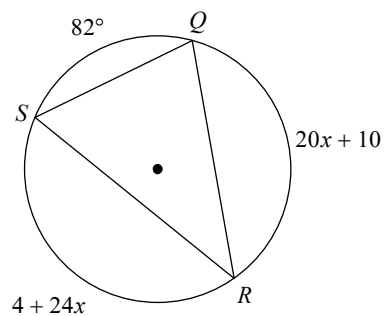

577) Find $m\angle EBC$

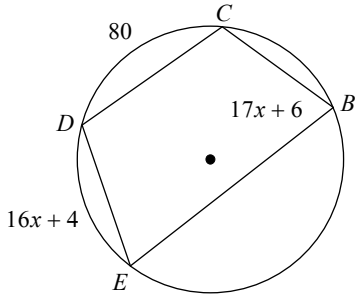

578) Find $m\angle GEF$

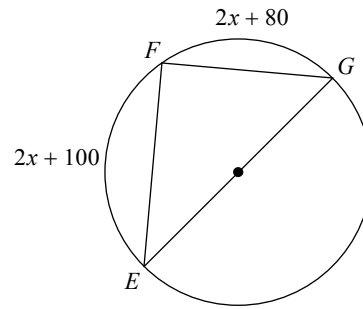

579) Find $m\angle XZY$

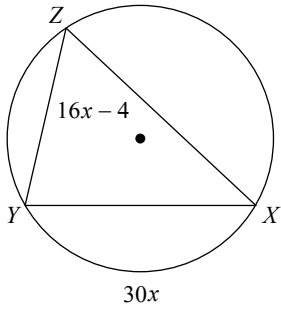

580) Find $m\angle QSR$

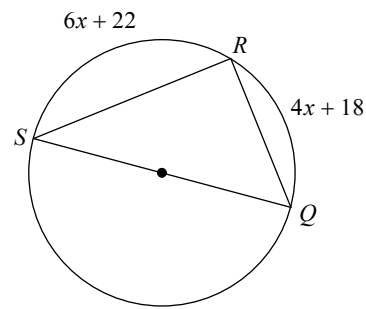

581) Find $m\angle YWX$

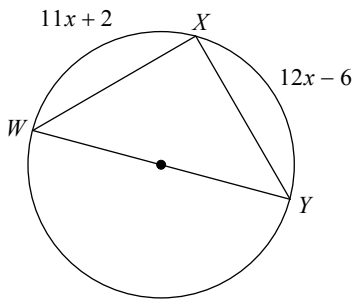

582) Find $m\angle YWX$

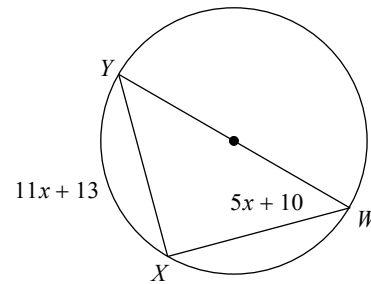

583) Find $m\angle KQR$

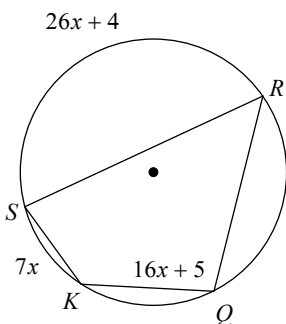

584) Find $m\angle PRQ$

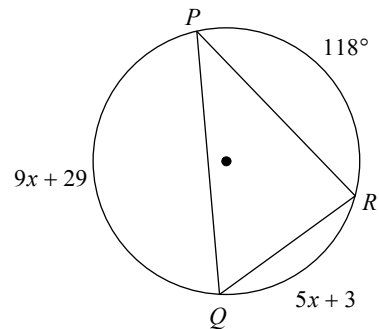

585) Find $m\angle ACB$

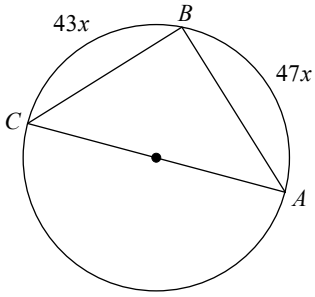

586) Find $m\angle FML$

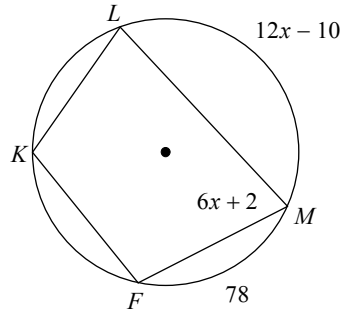

587) Find $m\angle GFH$

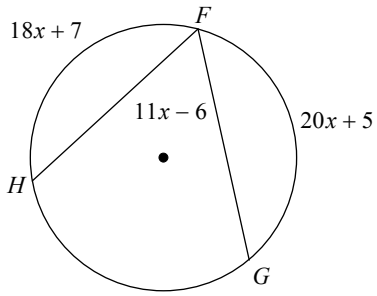

588) Find $m\angle KLJ$

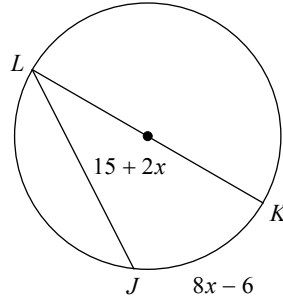

589) Find $m\angle WXV$

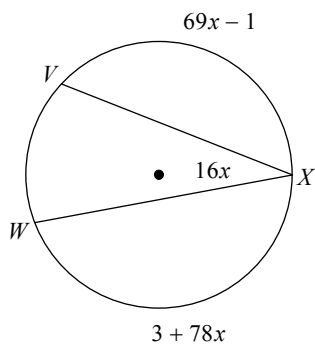

590) Find $m\angle CED$

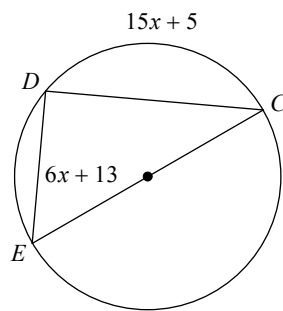

591) Find $m\angle QYP$

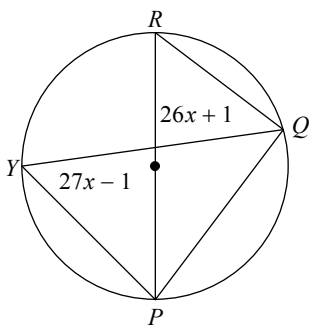

592) Find $m\angle RPQ$

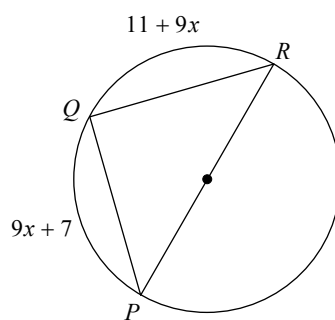

593) Find $m\angle XZY$

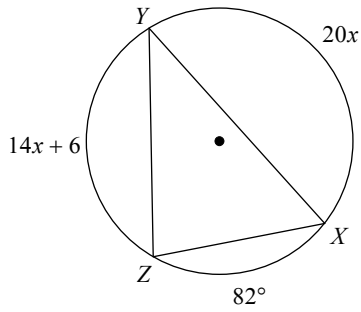

594) Find $m\angle RTS$

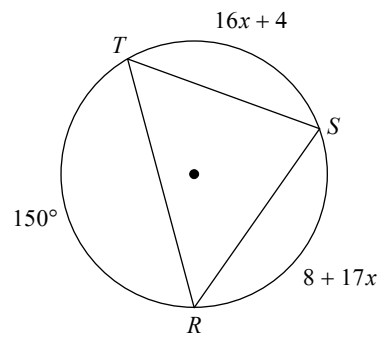

595) Find $m\angle XWY$

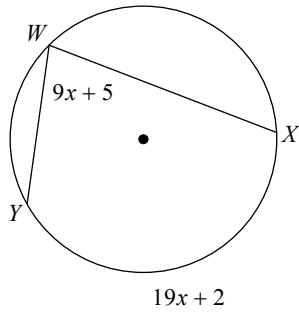

596) Find $m\angle NLM$

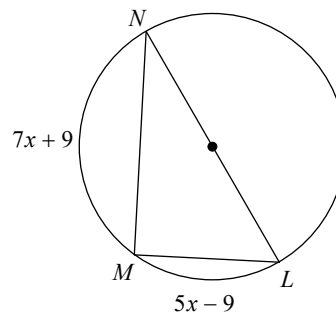

597) Find $m\angle LMK$

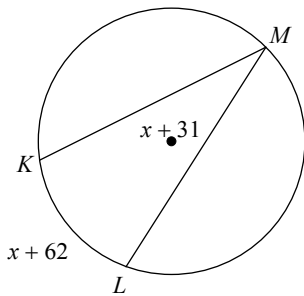

598) Find $m\angle XZY$

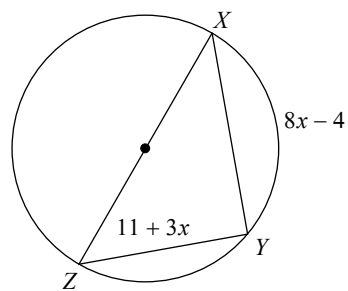

599) Find $m\angle PGF$

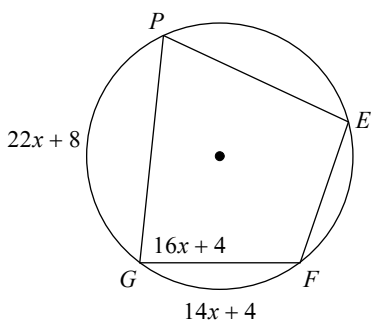

600) Find $m\angle VGF$

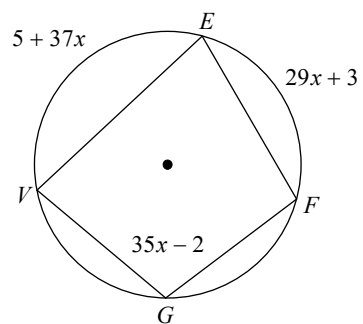

601) Find $m\angle KYX$

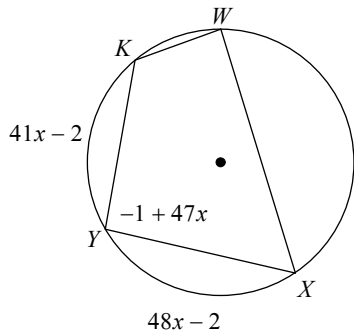

602) Find $m\angle FWH$

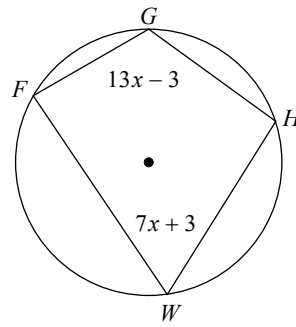

603) Find $m\angle MKL$

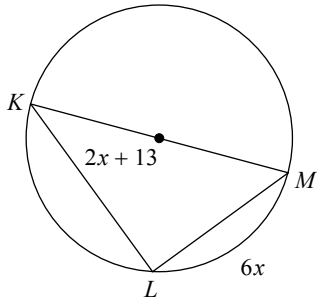

604) Find $m\angle RPQ$

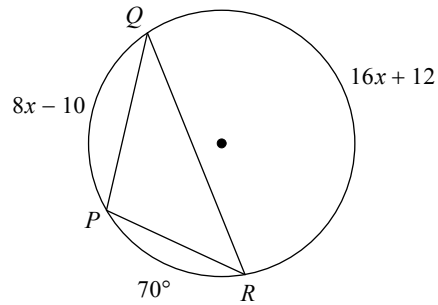

605) Find $m\angle KJL$

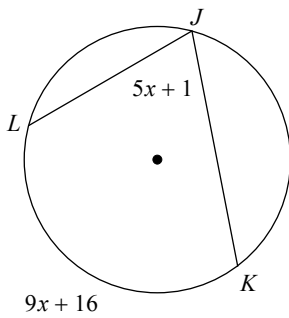

606) Find $m\angle FEG$

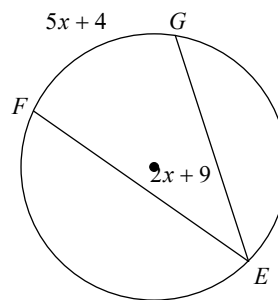

607) Find $m\angle ZXY$

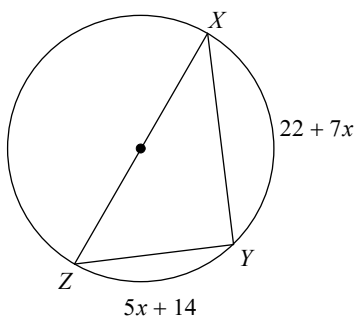

608) Find $m\angle GHF$

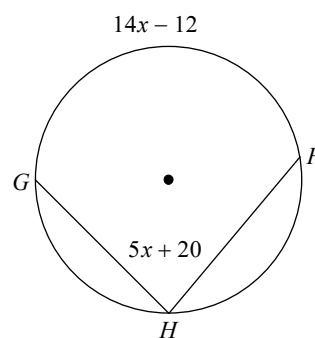

609) Find $m\angle SFT$

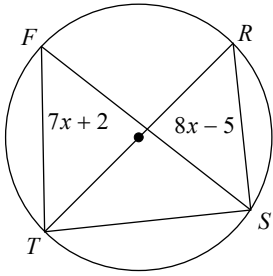

610) Find $m\angle WYX$

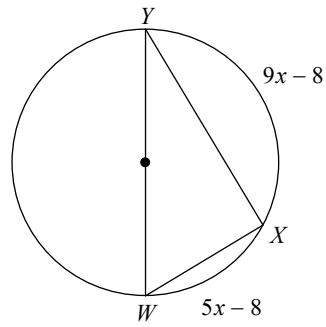

611) Find $m\angle QAP$

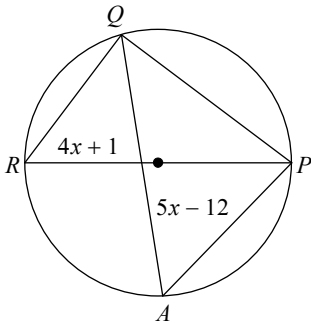

612) Find $m\angle QPR$

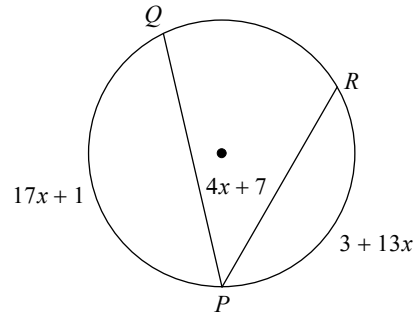

613) Find $m\angle KJL$

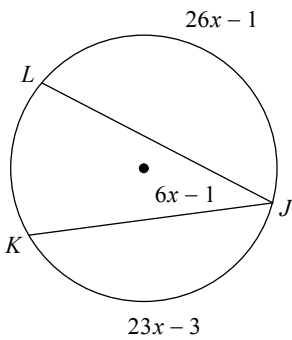

614) Find $m\angle BCA$

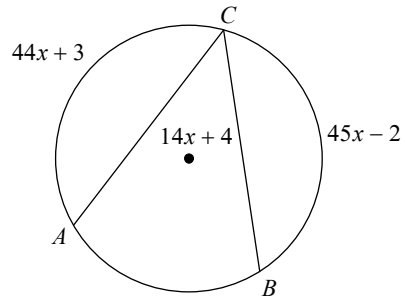

615) Find $m\angle RPQ$

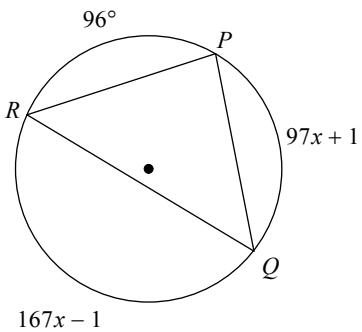

616) Find $m\angle WVX$

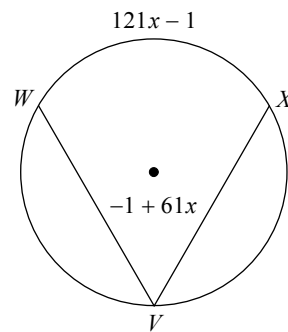

617) Find $m\angle LMK$

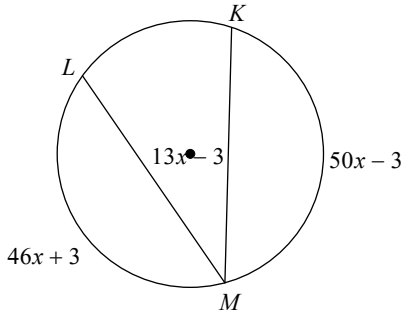

618) Find $m\angle FZY$

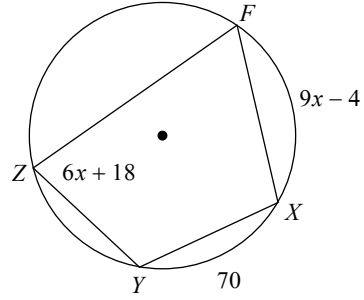

619) Find $m\angle VCB$

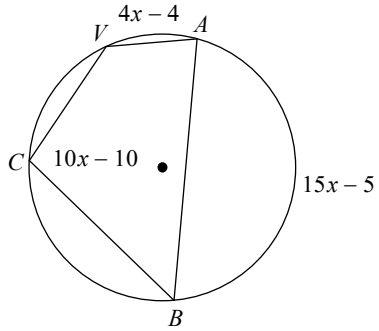

620) Find $m\angle CWX$

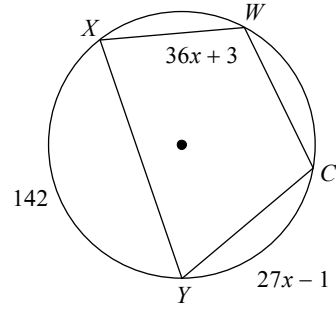

621) Find $m\angle LRN$

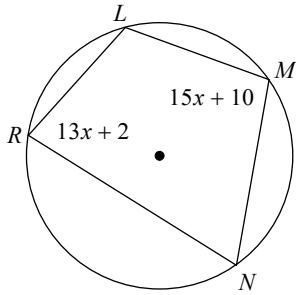

622) Find $m\angle GFH$

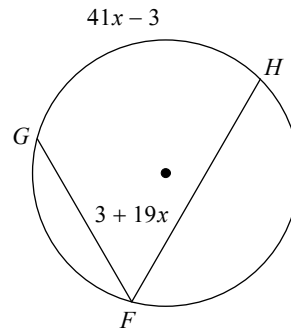

623) Find $m\angle FGE$

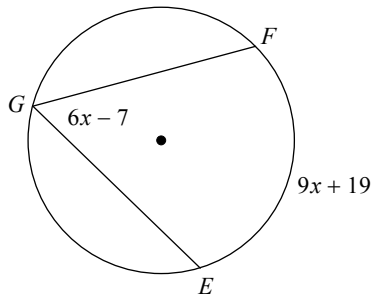

624) Find $m\angle RQS$

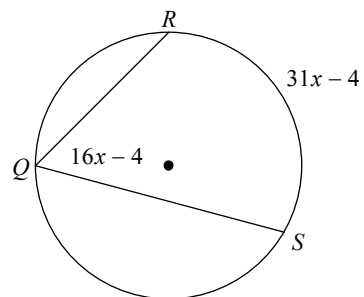

625) Find $m\angle XRS$

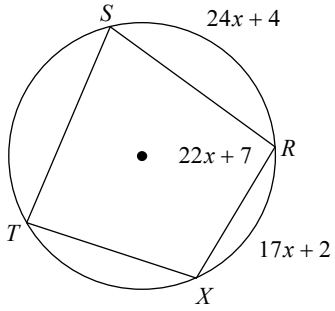

626) Find $m\angle RQS$

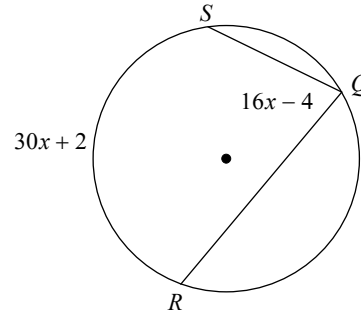

627) Find $m\angle YTS$

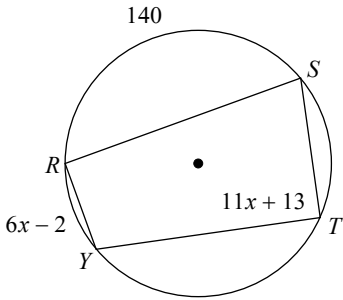

628) Find $m\angle MNL$

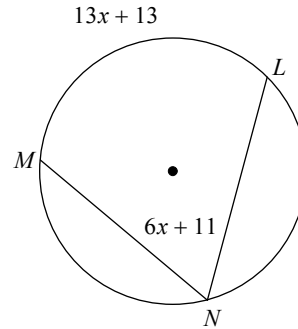

629) Find $m\angle ZXY$

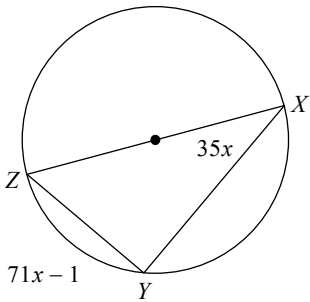

630) Find $m\angle FXW$

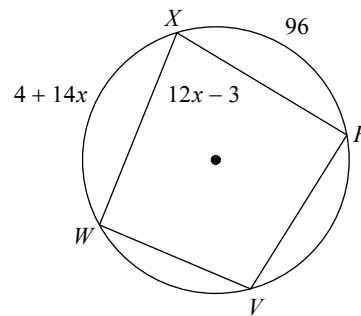

631) Find $m\angle FDE$

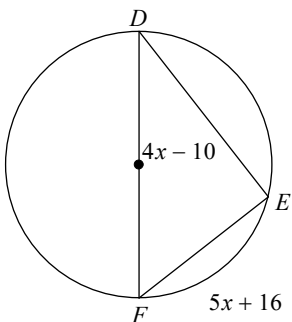

632) Find $m\angle BPC$

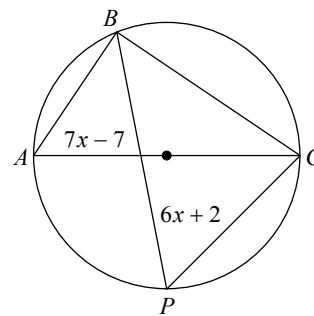

633) Find $m\angle XSR$

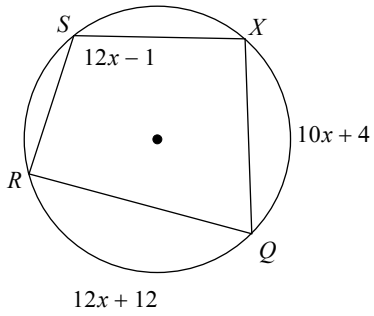

634) Find $m\angle CKL$

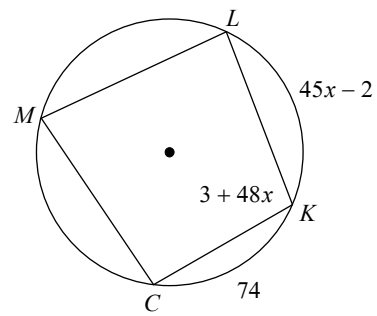

635) Find $m\angle YWX$

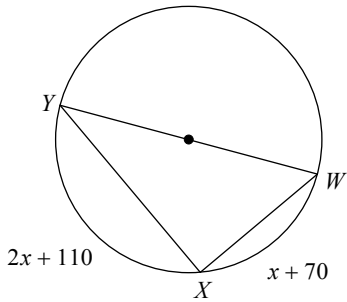

636) Find $m\angle FGH$

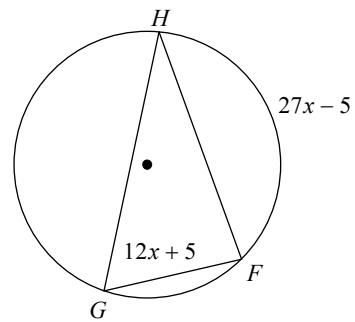

637) Find $m\angle PWR$

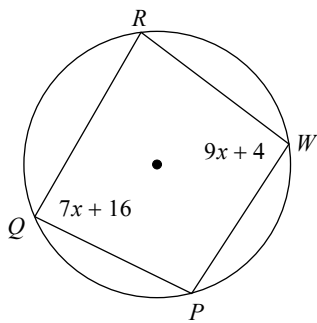

638) Find $m\angle SQR$

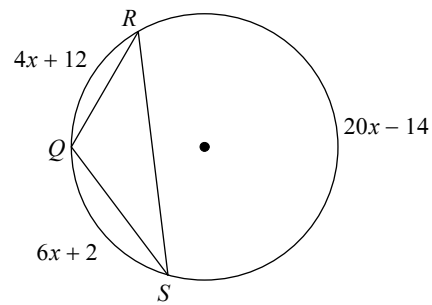

639) Find $m\angle CSR$

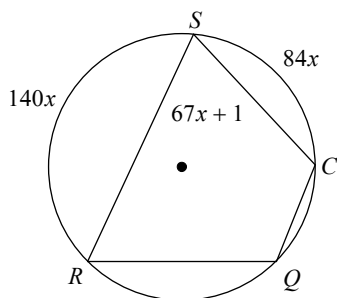

640) Find $m\angle WNX$

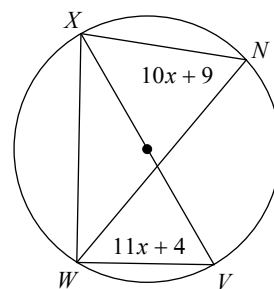

Find the angle measure by solving the system of equations

641)

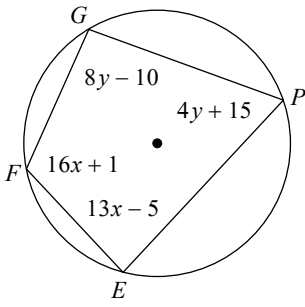

642)

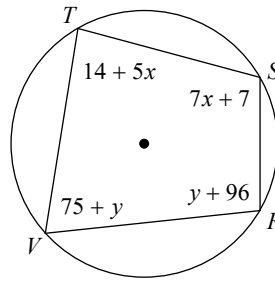

643)

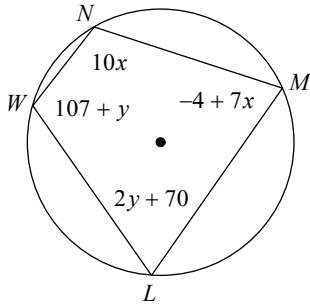

644)

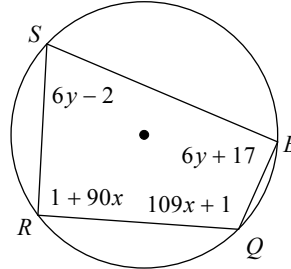

645)

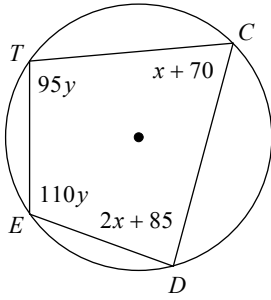

646)

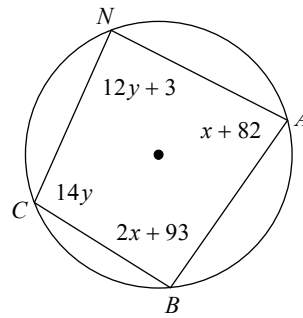

647)

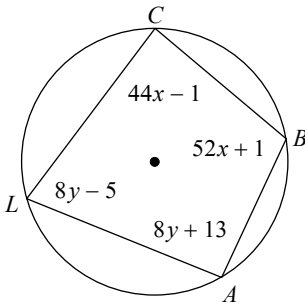

648)

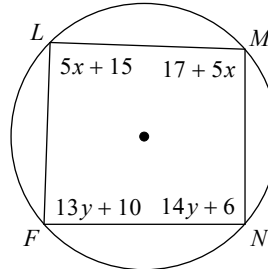

649)

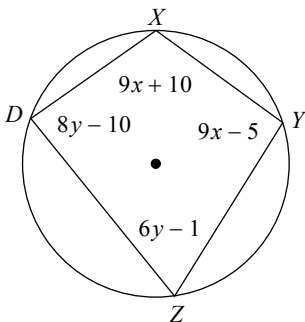

650)

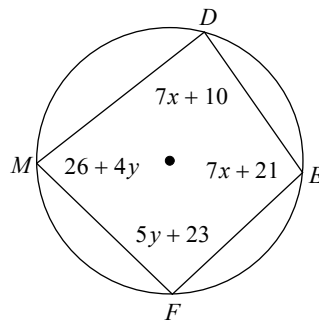

651)

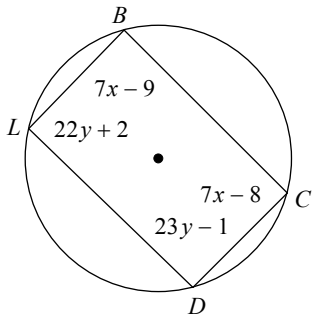

652)

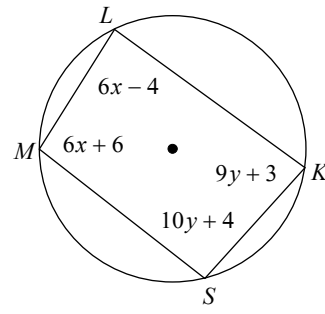

653)

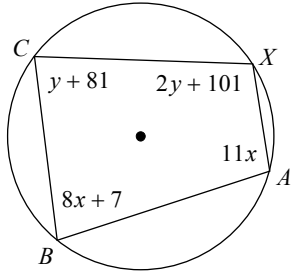

654)

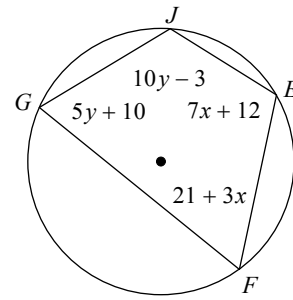

655)

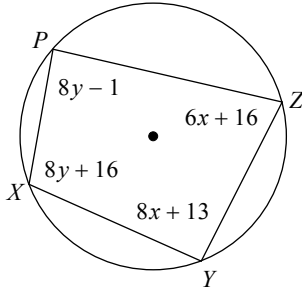

656)

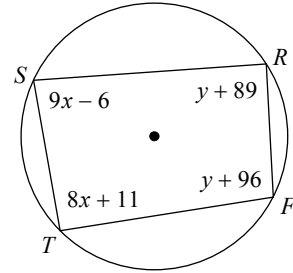

657)

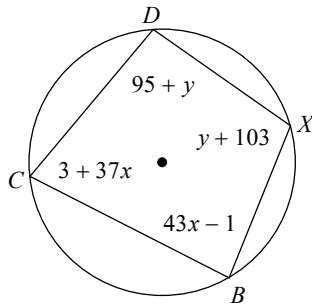

658)

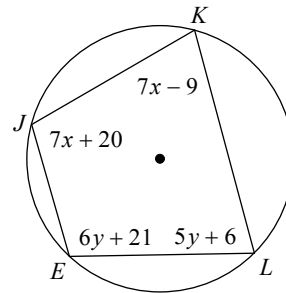

659)

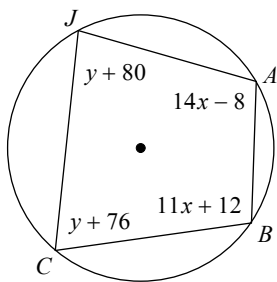

660)

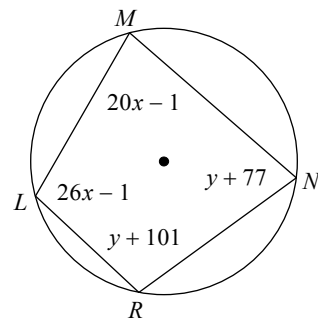

661)

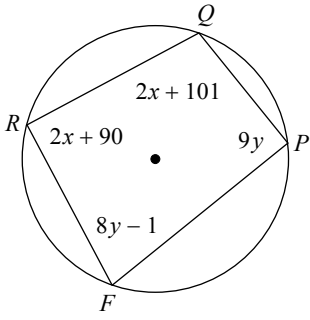

662)

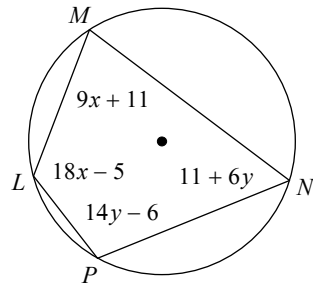

663)

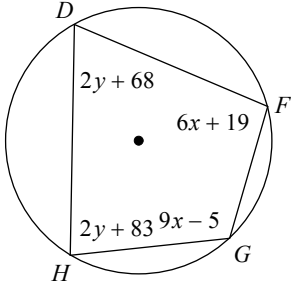

664)

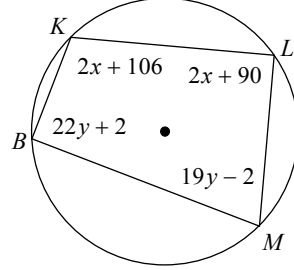

665)

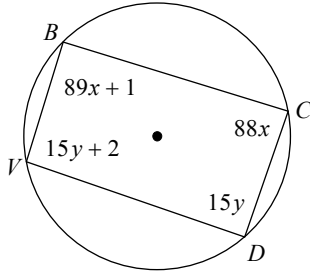

666)

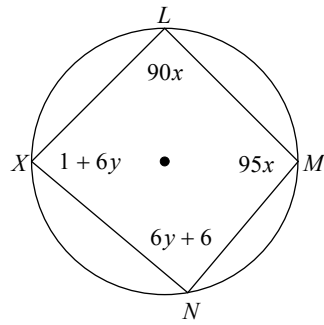

667)

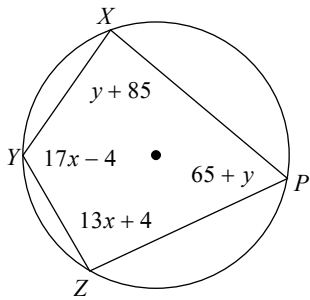

668)

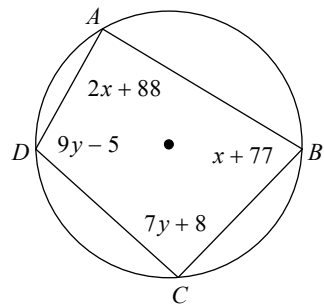

669)

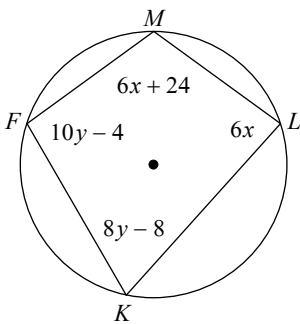

670)

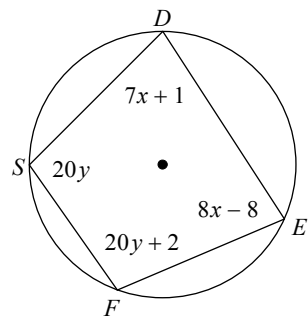

671)

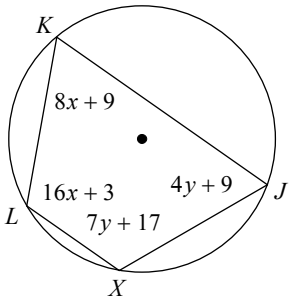

672)

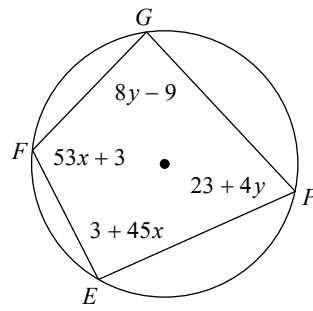

673)

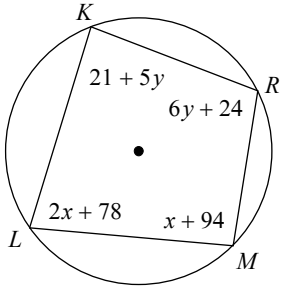

674)

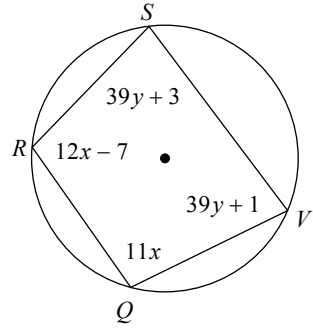

675)

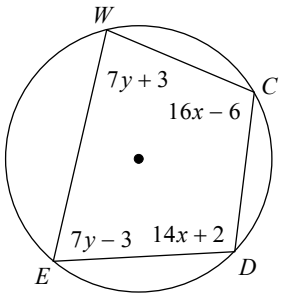

676)

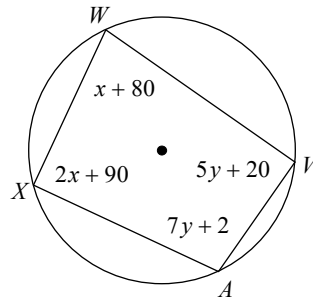

677)

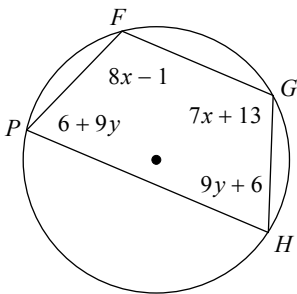

678)

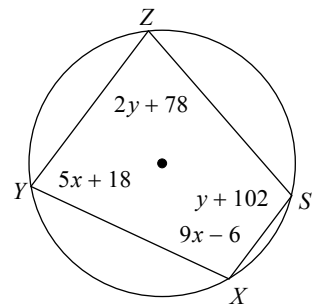

679)

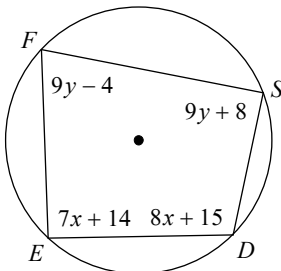

680)

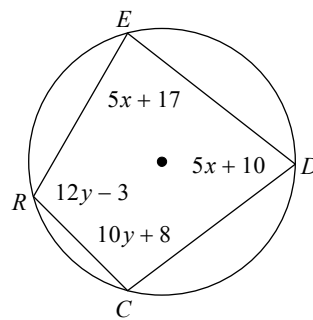

681)

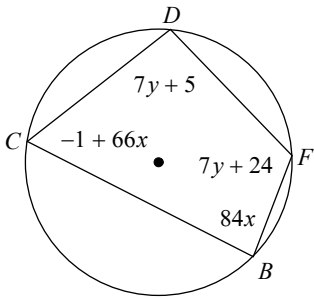

682)

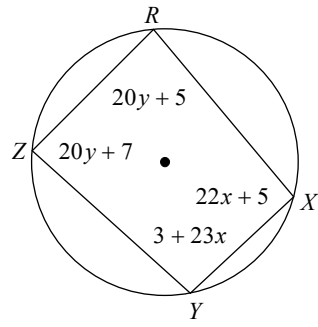

683)

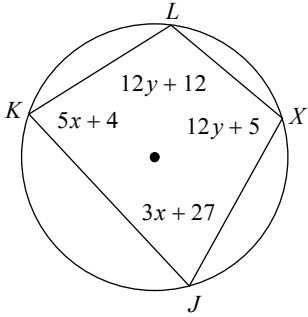

684)

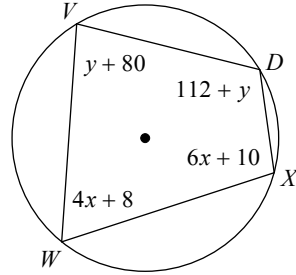

685)

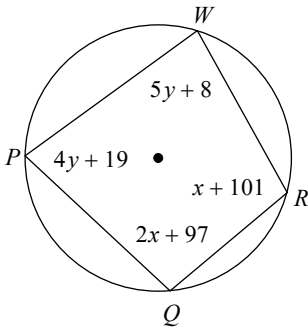

686)

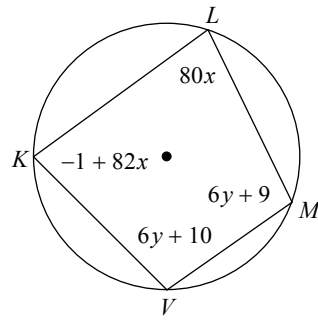

Find the angle measure by solving the unknown

687)

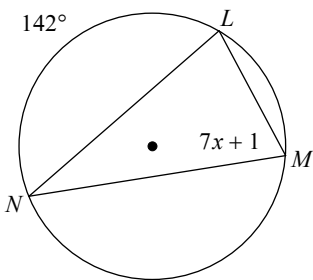

688)

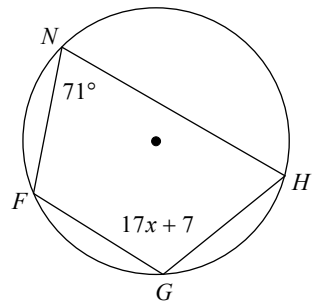

689)

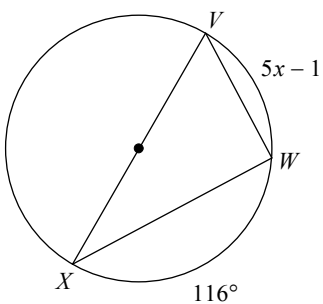

690)

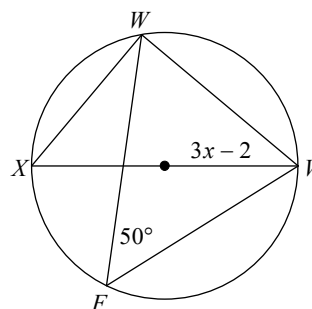

691)

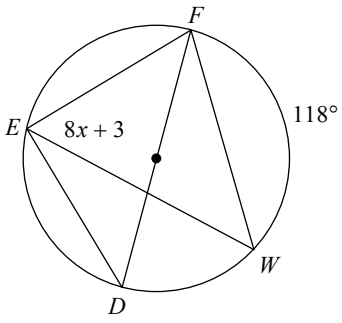

692)

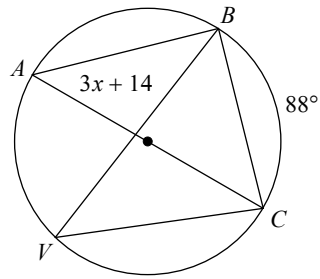

693)

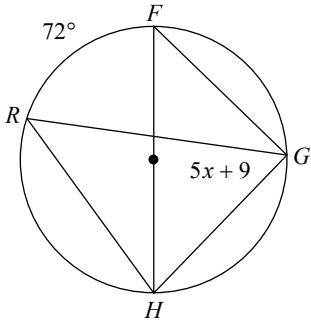

694)

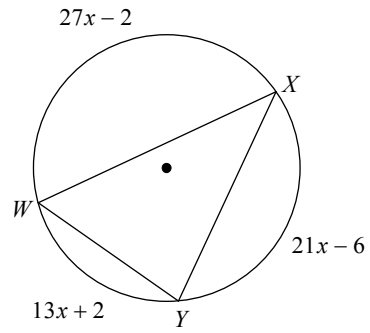

695)

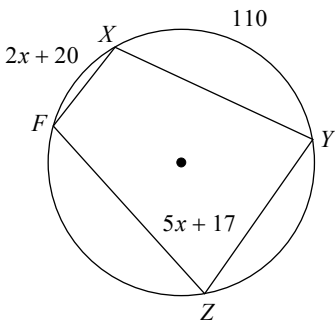

696)

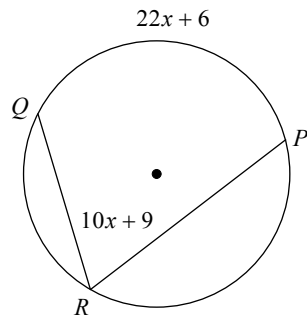

697)

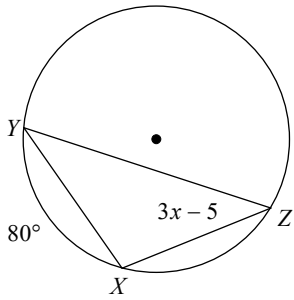

698)

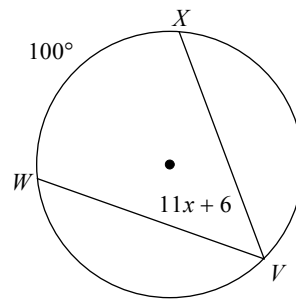

699)

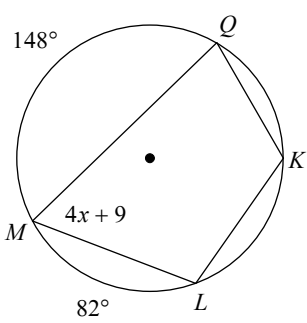

700)

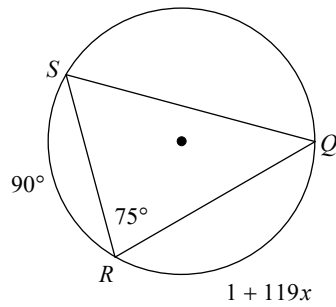

701)

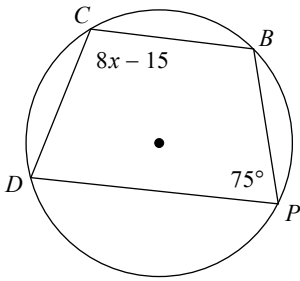

702)

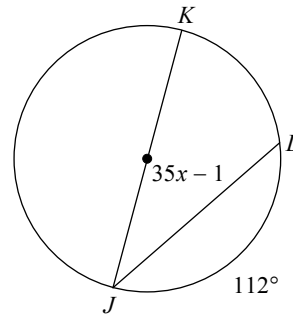

703)

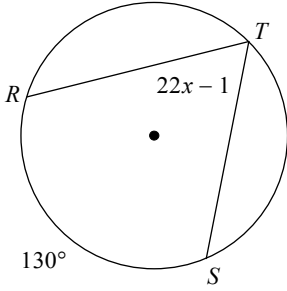

704)

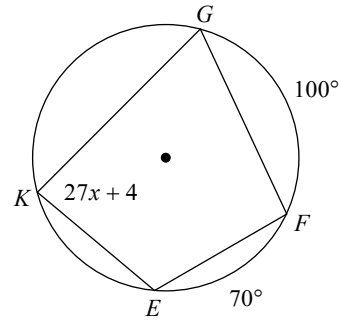

705)

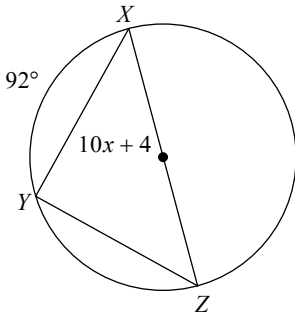

706)

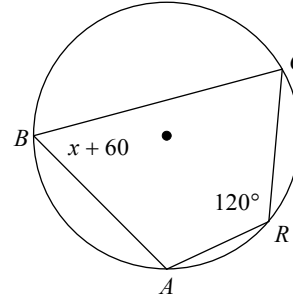

707)

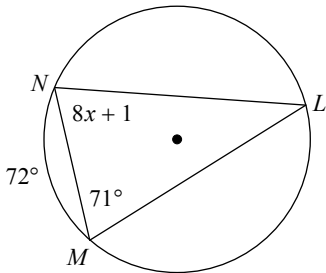

708)

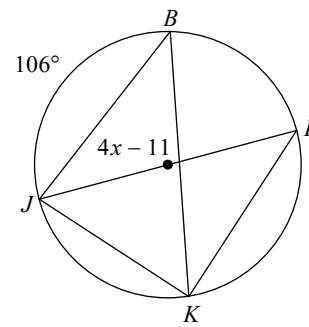

709)

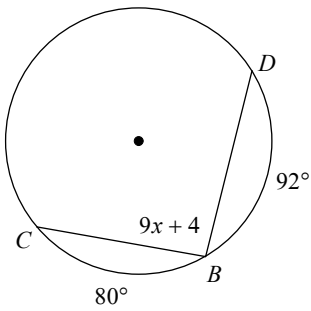

710)

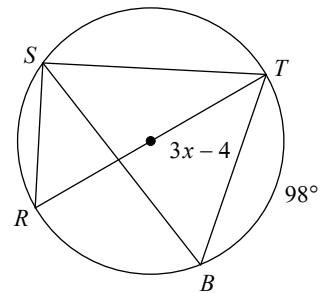

711)

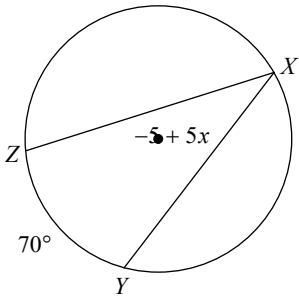

712)

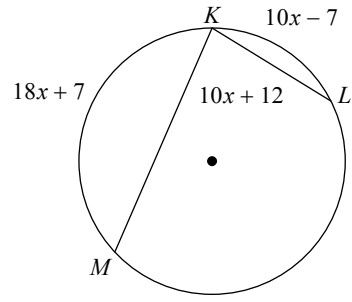

713)

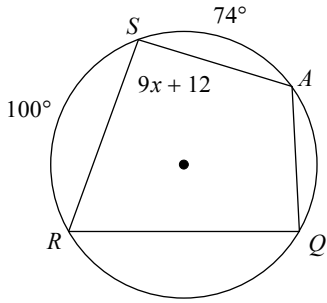

714)

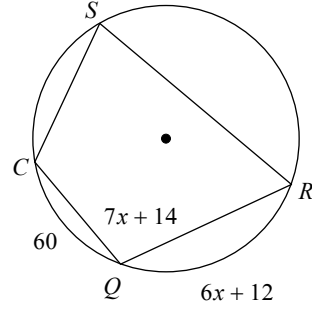

715)

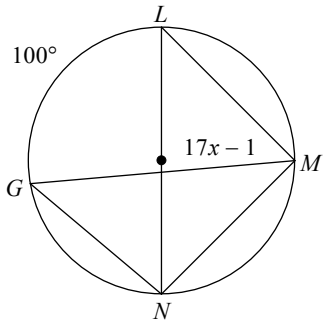

716)

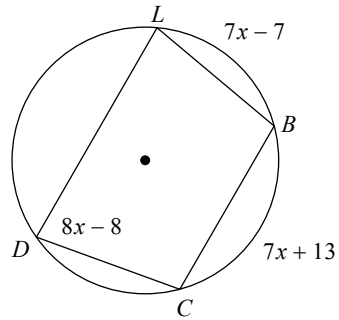

717)

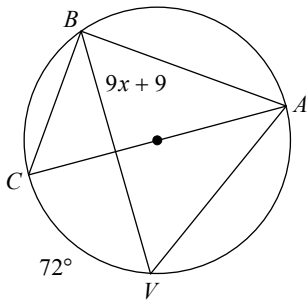

718)

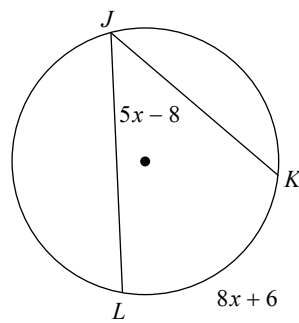

719)

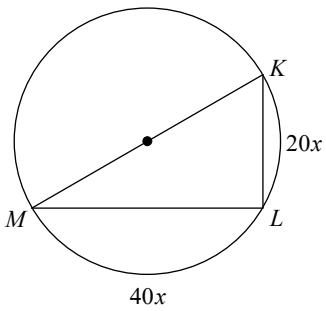

720)

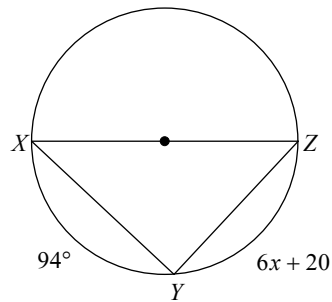

721)

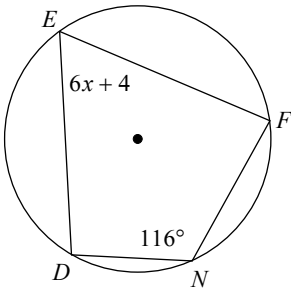

722)

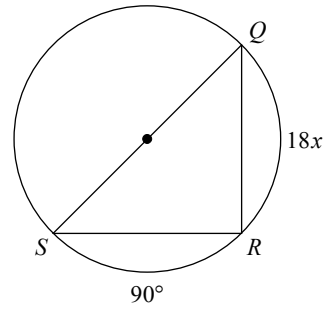

723)

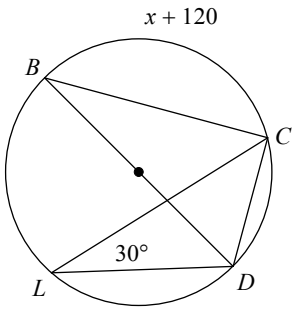

724)

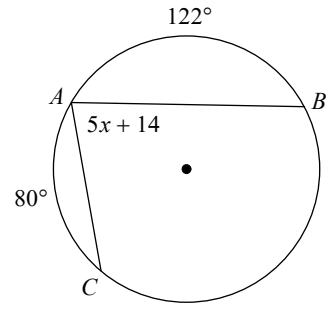

725)

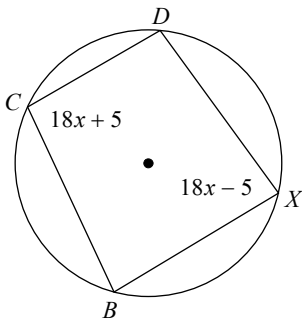

726)

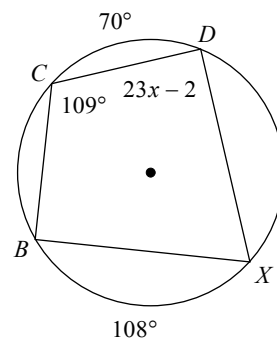

727)

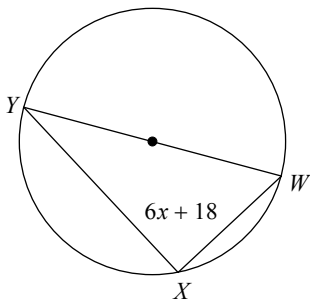

728)

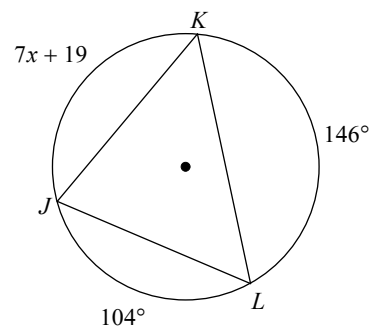

729)

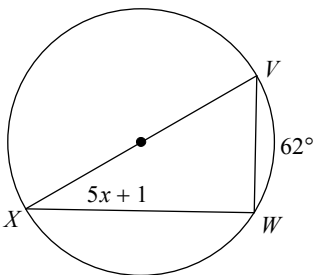

730)

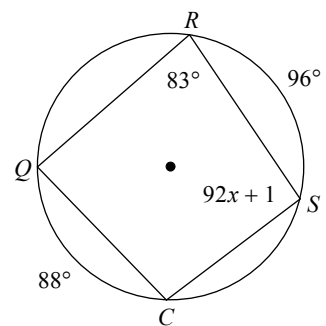

731)

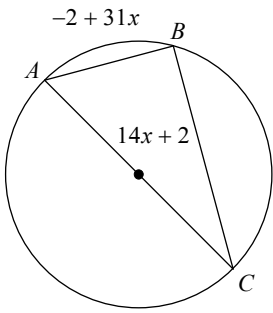

732)

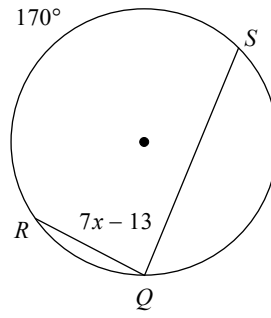

733)

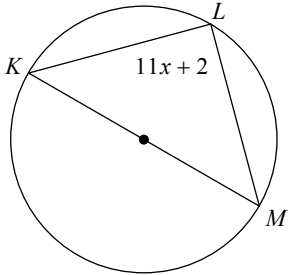

734)

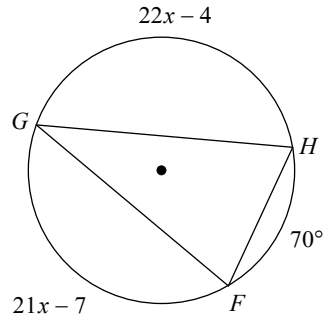

735)

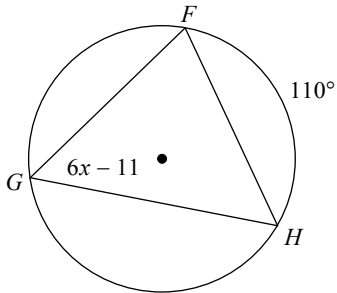

736)

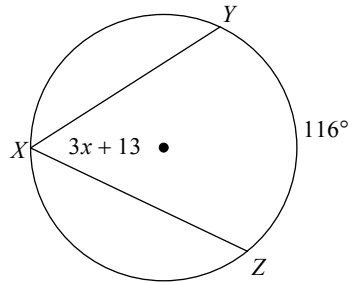

737)

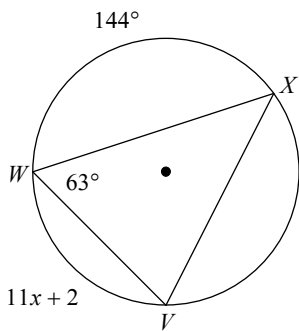

738)

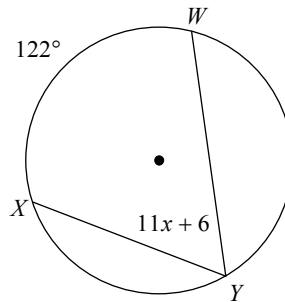

739)

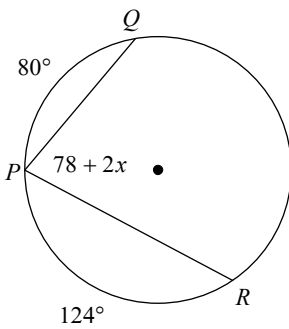

740)

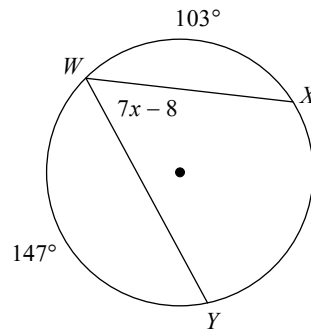

741)

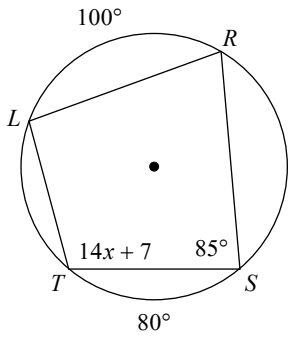

742)

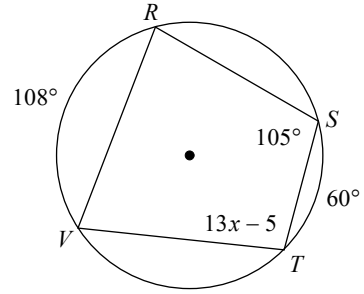

743)

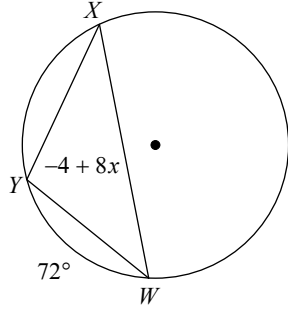

744)

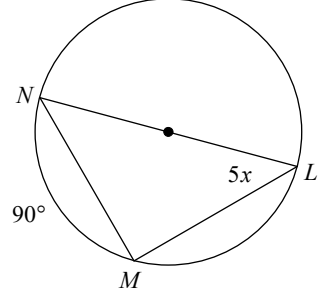

745)

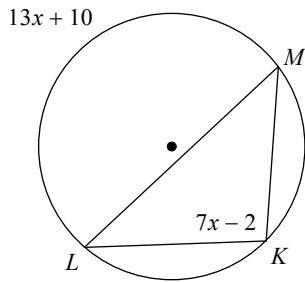

746)

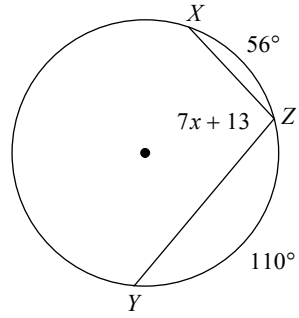

747)

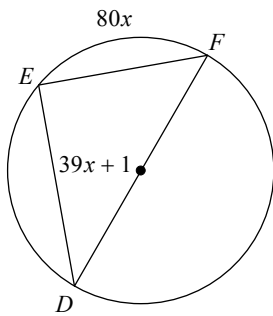

748)

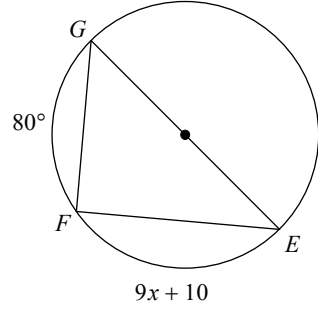

749)

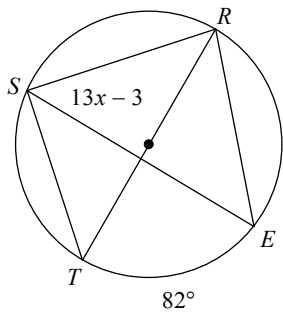

750)

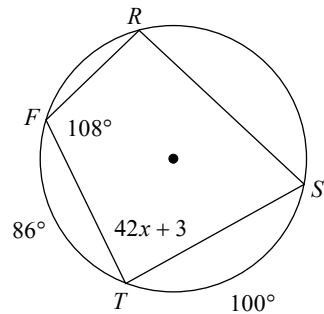

751)

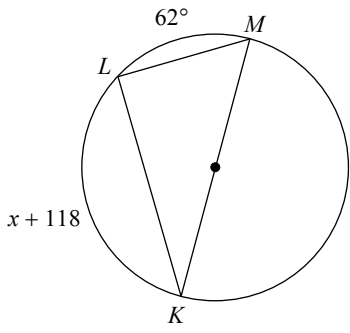

752)

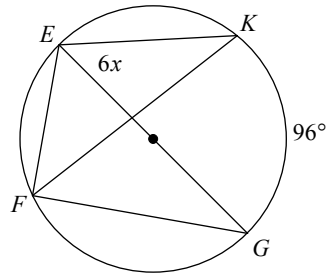

753)

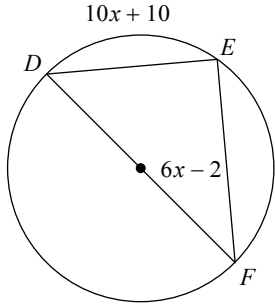

754)

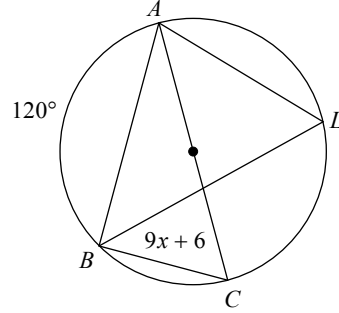

755)

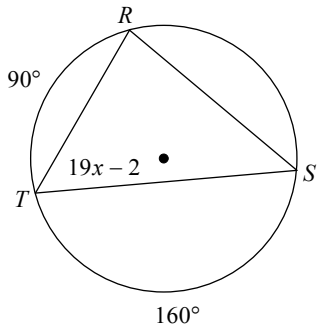

756)

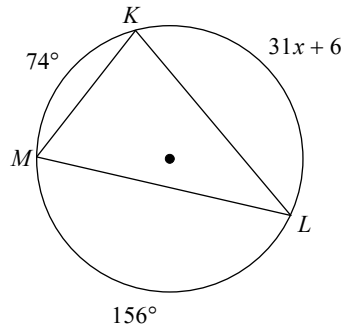

757)

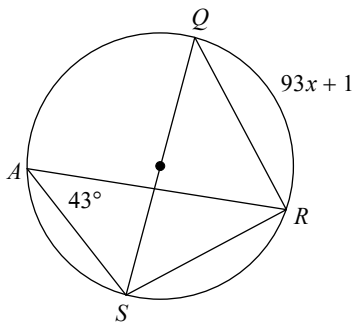

758)

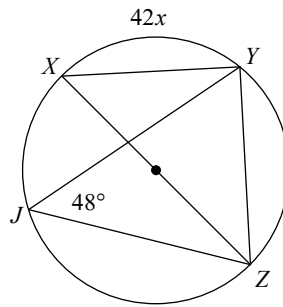

759)

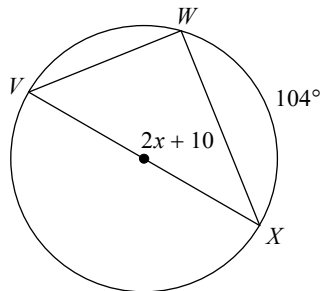

760)

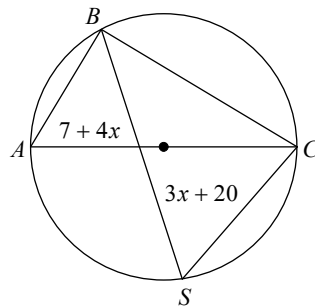

761)

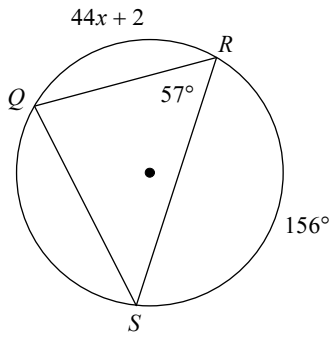

762)

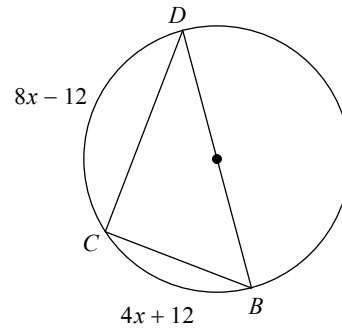

763)

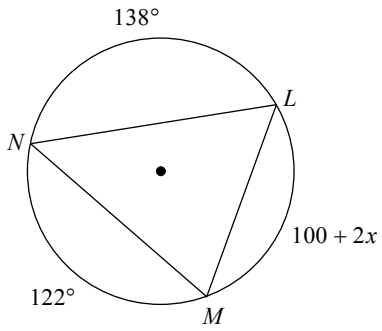

764)

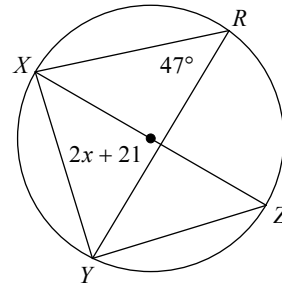

765)

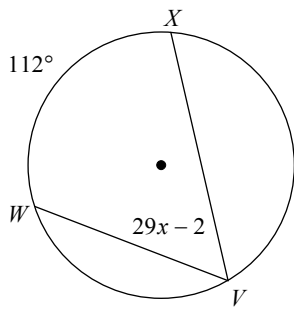

766)

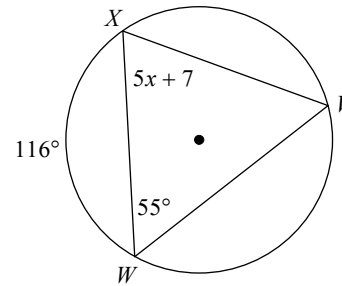

767) Find $m\angle KJL$

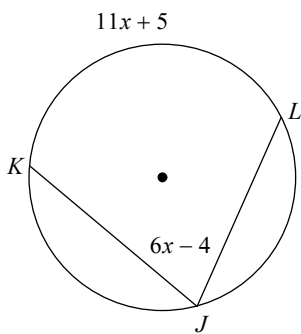

768) Find $m\angle WVX$

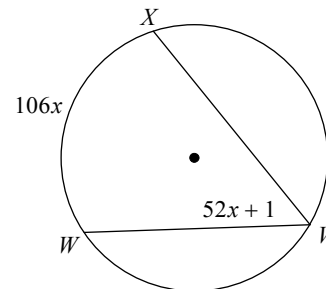

769) Find $m\angle YXZ$

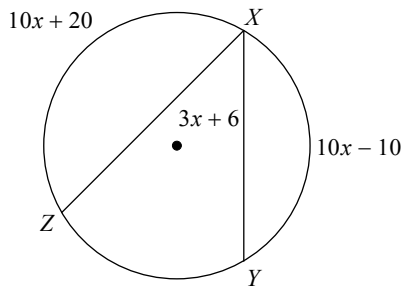

770) Find $m\angle FSG$

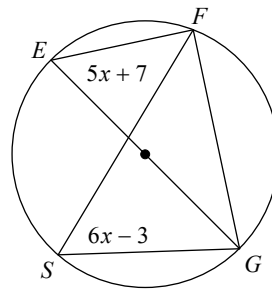

771) Find $m\angle RTS$

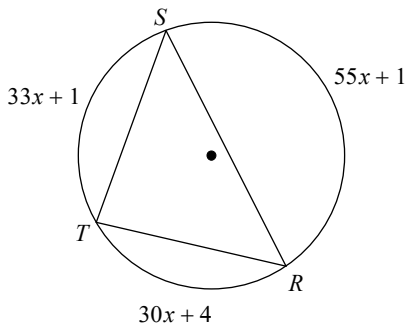

772) Find $m\angle MKL$

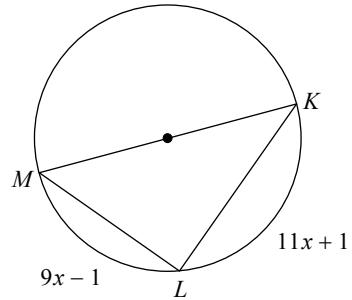

773) Find $m\angle BDC$

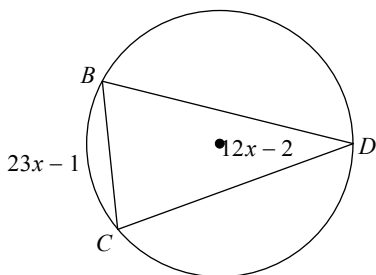

774) Find $m\angle GHF$

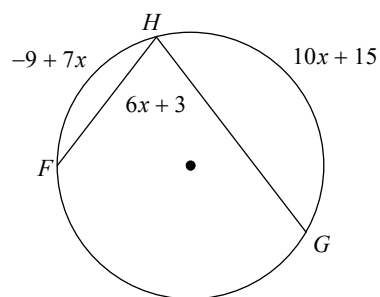

775) Find $m\angle YWX$

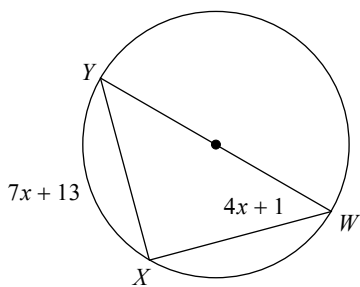

776) Find $m\angle XVW$

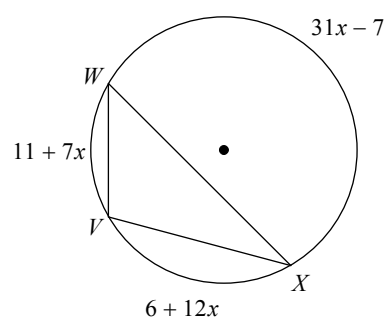

777) Find $m\angle YZX$

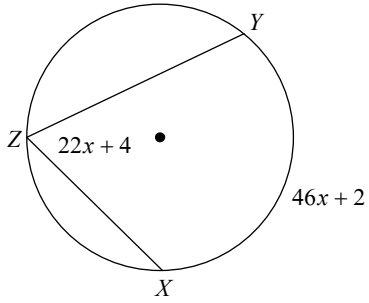

778) Find $m\angle WXV$

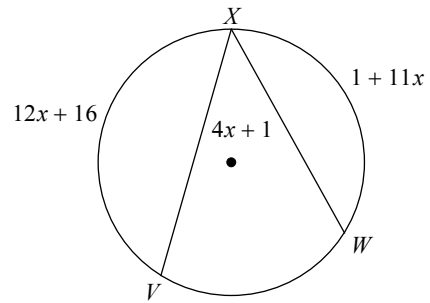

779) Find $m\angle JZY$

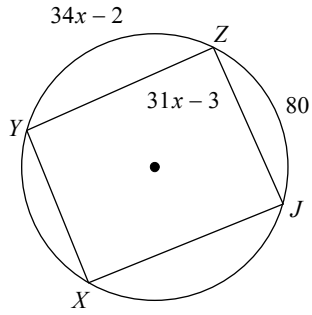

780) Find $m\angle BAC$

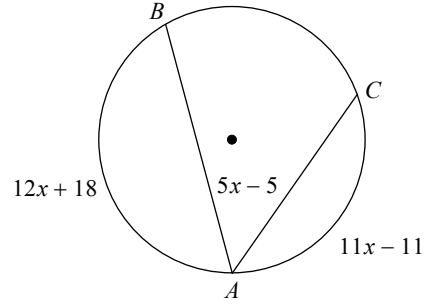

781) Find $m\angle KYX$

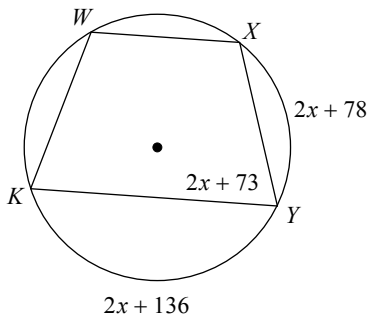

782) Find $m\angle LCB$

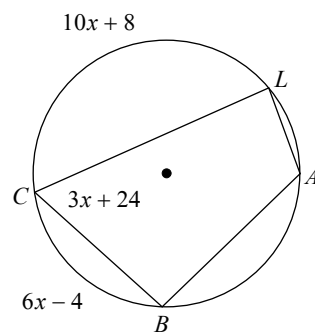

783) Find $m\angle EDF$

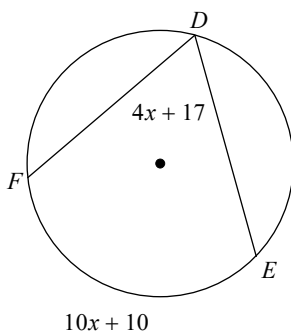

784) Find $m\angle EDF$

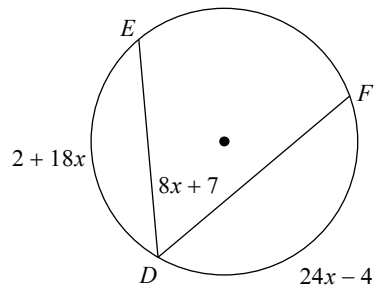

785) Find $m\angle DLM$

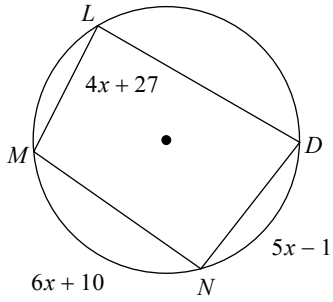

786) Find $m\angle MLN$

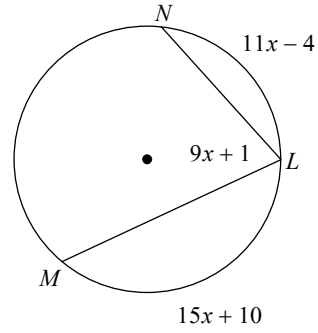

787) Find $m\angle FEG$

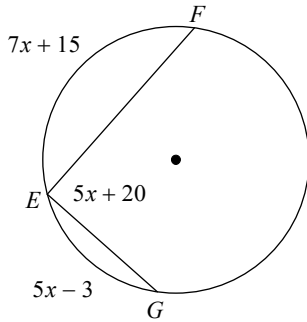

788) Find $m\angle QZY$

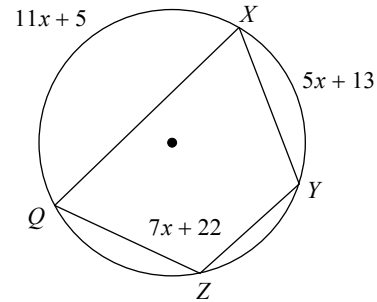

789) Find $m\angle ZXY$

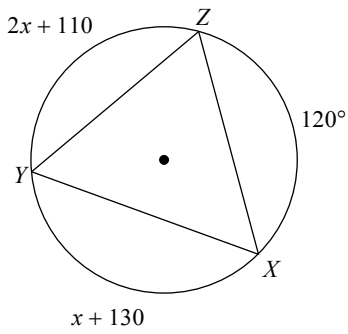

790) Find $m\angle SQR$

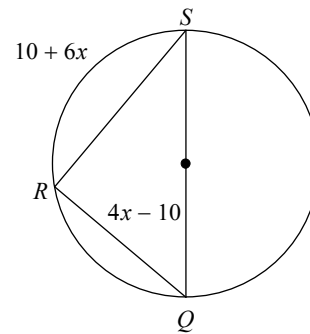

791) Find $m\angle EGF$

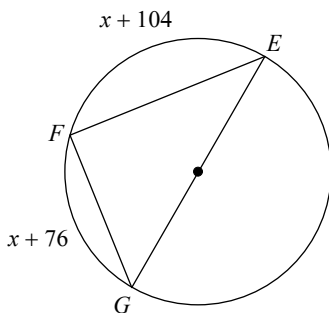

792) Find $m\angle NFE$

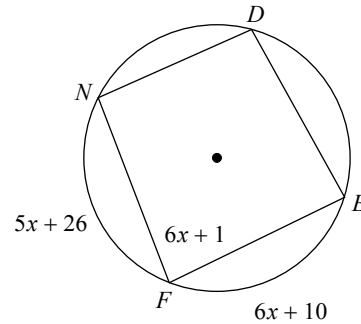

793) Find $m\angle EFD$

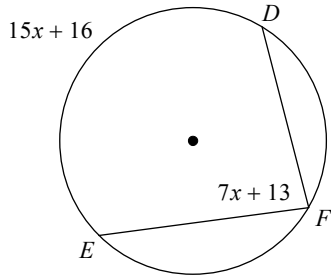

794) Find $m\angle CAB$

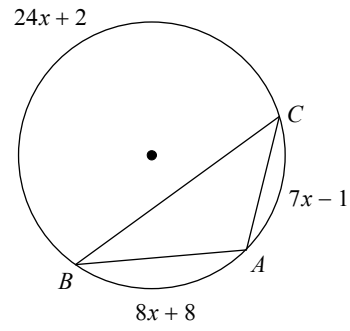

795) Find $m\angle WQY$

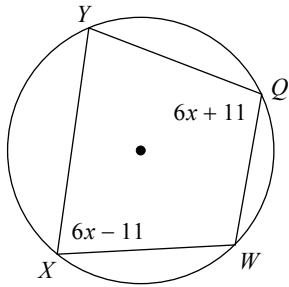

796) Find $m\angle EDF$

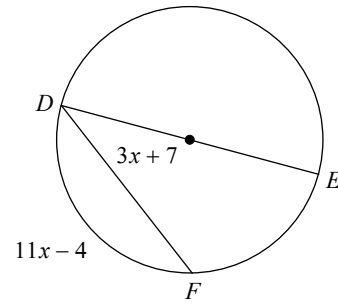

797) Find $m\angle SJR$

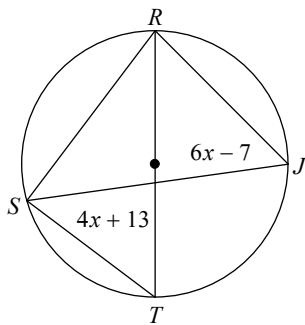

798) Find $m\angle YZX$

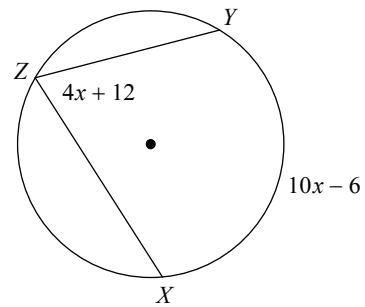

799) Find $m\angle RQS$

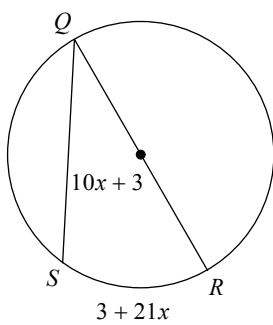

800) Find $m\angle RES$

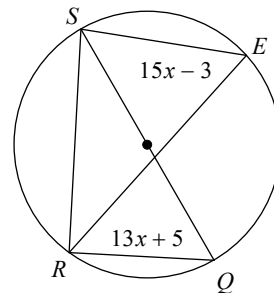

801) Find $m\angle ACB$

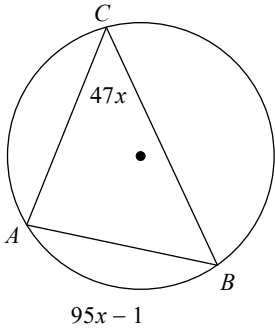

802) Find $m\angle ACB$

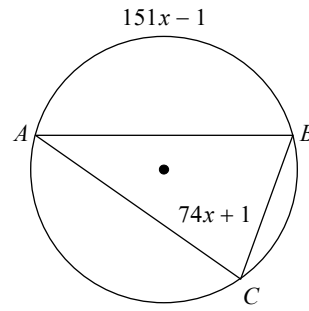

803) Find $m\angle DZY$

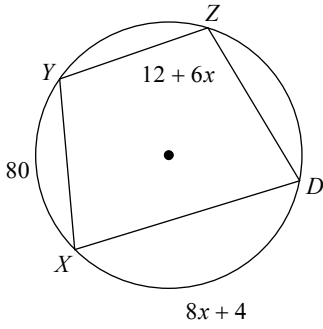

804) Find $m\angle DJK$

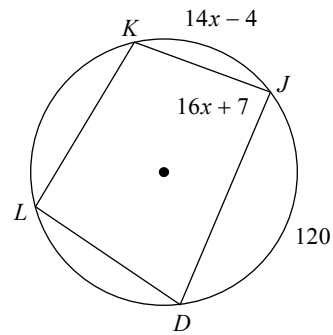

805) Find $m\angle EFD$

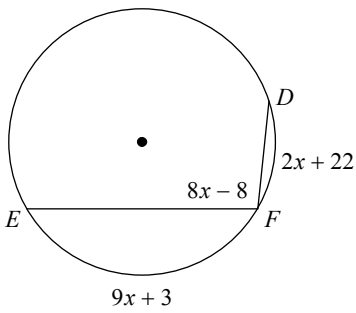

806) Find $m\angle LMK$

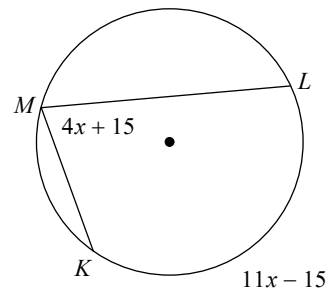

807) Find $m\angle CDB$

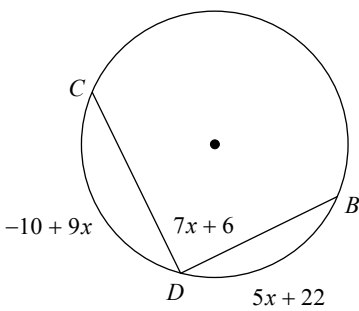

808) Find $m\angle CAB$

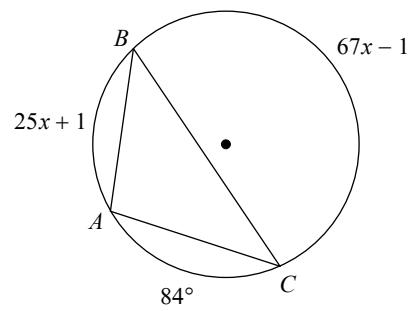

809) Find $m\angle SQR$

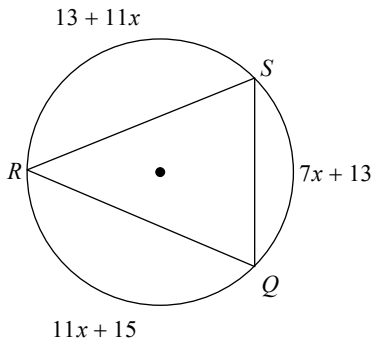

810) Find $m\angle WKY$

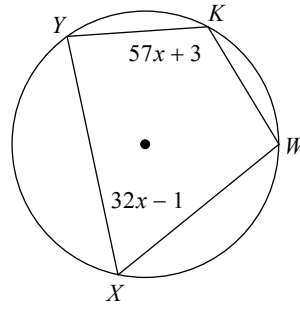

811) Find $m\angle LAM$

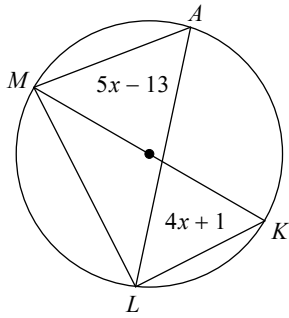

812) Find $m\angle BCA$

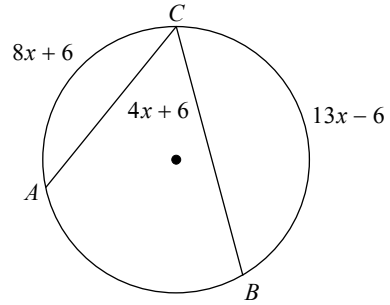

813) Find $m\angle NLM$

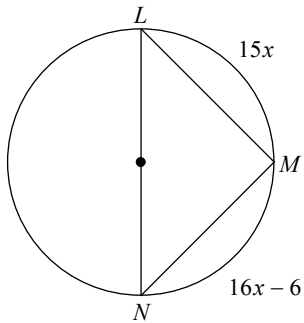

814) Find $m\angle ZXY$

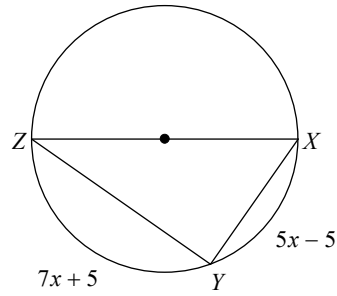

815) Find $m\angle EQR$

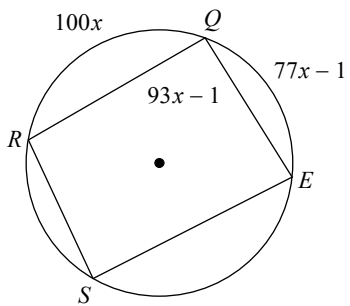

816) Find $m\angle WYX$

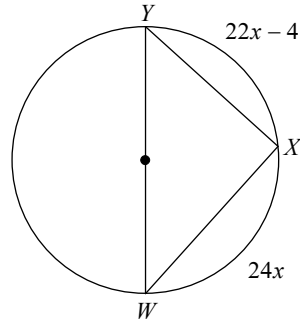

817) Find $m\angle YXZ$

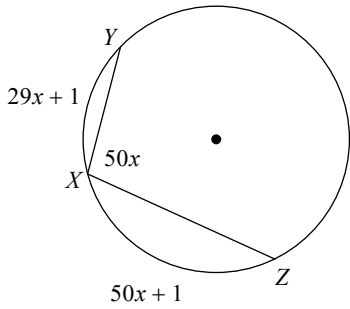

818) Find $m\angle KGF$

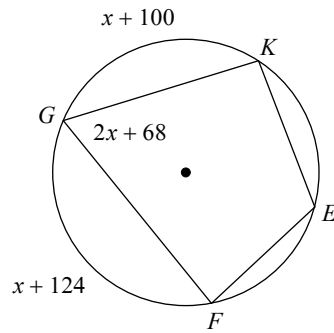

819) Find $m\angle KDC$

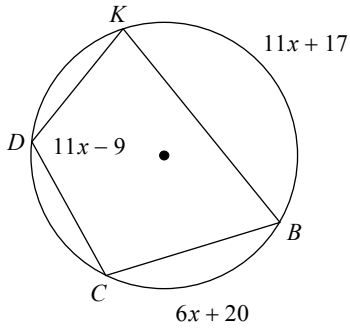

820) Find $m\angle LQJ$

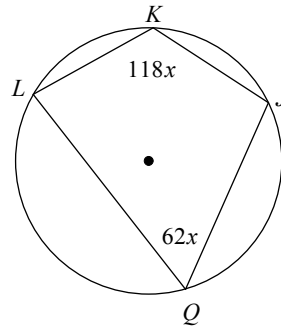

821) Find $m\angle TRS$

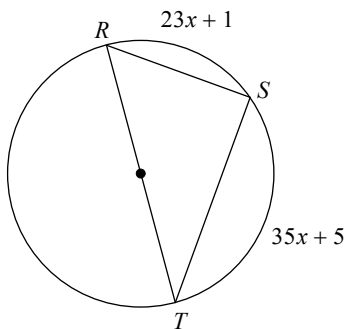

822) Find $m\angle ACB$

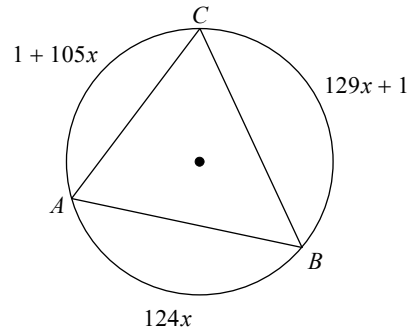

823) Find $m\angle DBC$

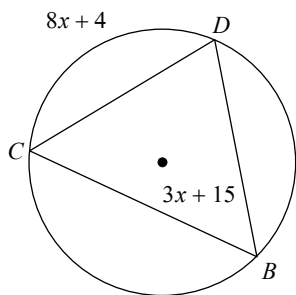

824) Find $m\angle CKD$

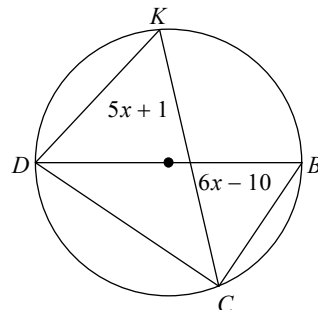

825) Find $m\angle CFD$

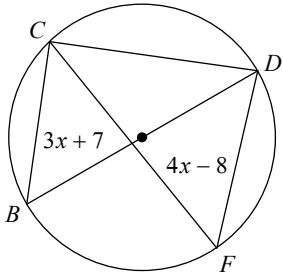

826) Find $m\angle RNM$

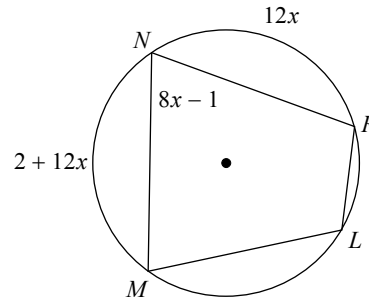

827) Find $m\angle WEF$

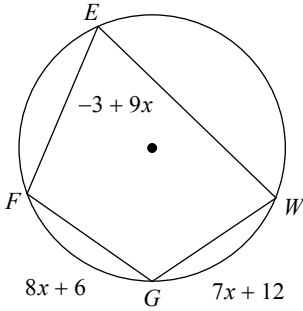

828) Find $m\angle KLJ$

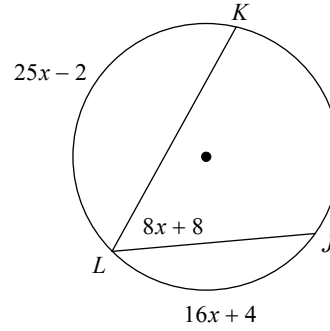

829) Find $m\angle PAR$

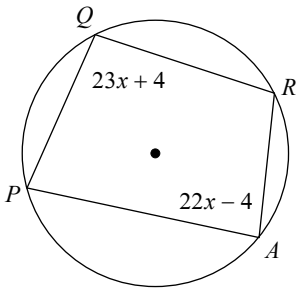

830) Find $m\angle NBC$

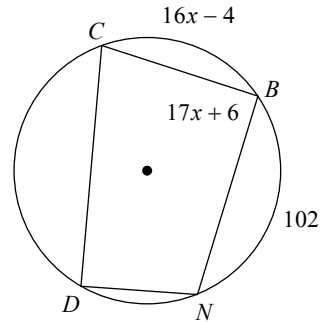

831) Find $m\angle LMK$

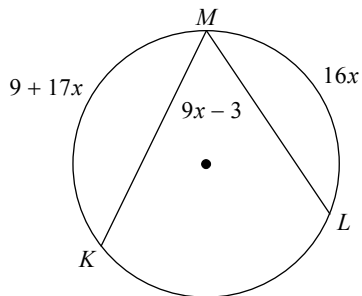

832) Find $m\angle HQR$

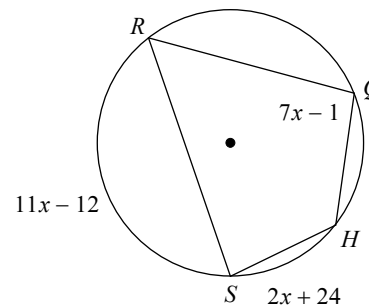

833) Find $m\angle XWY$

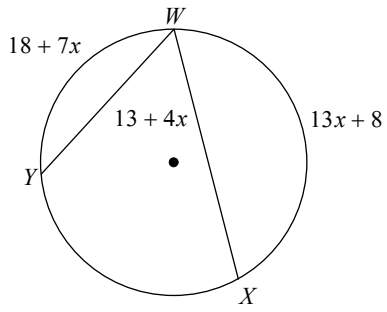

834) Find $m\angle GRH$

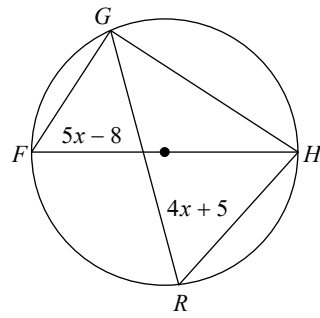

835) Find $m\angle XCD$

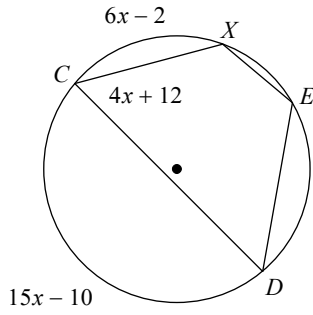

836) Find $m\angle SQR$

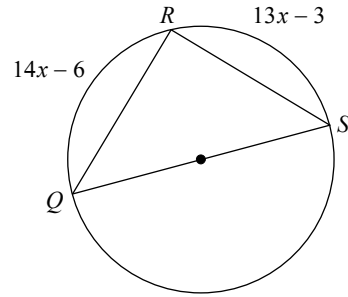

837) Find $m\angle XWY$

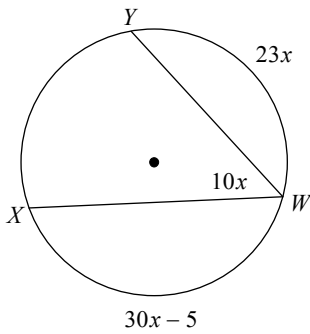

838) Find $m\angle WSR$

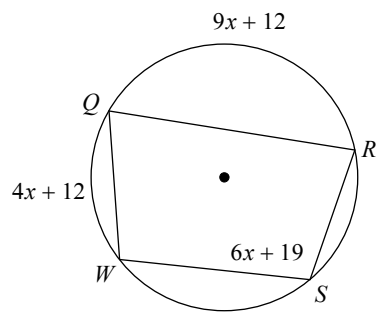

839) Find $m\angle QPR$

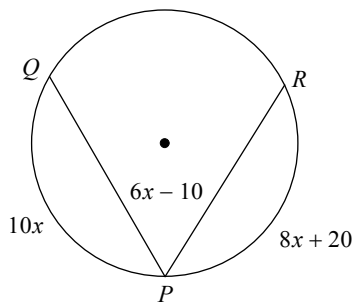

840) Find $m\angle XYW$

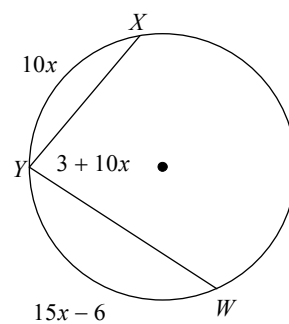

841) Find $m\angle LBJ$

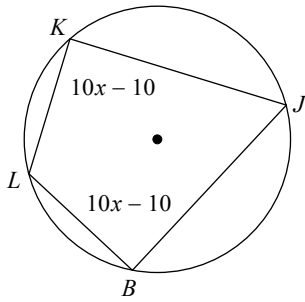

842) Find $m\angle GFH$

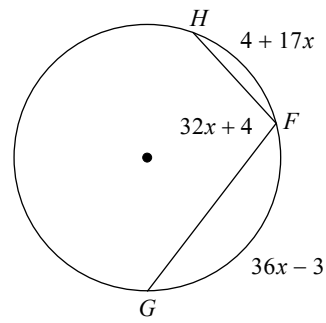

843) Find $m\angle RQS$

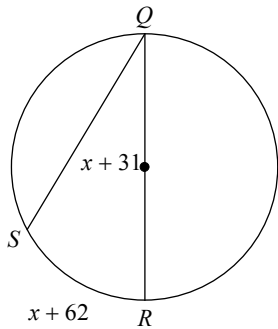

844) Find $m\angle HFG$

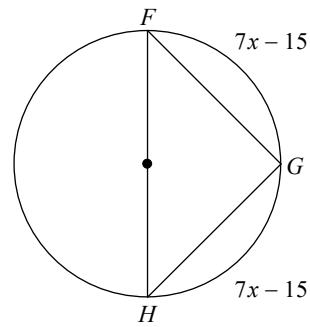

845) Find $m\angle ATS$

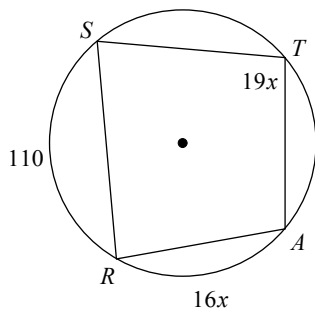

846) Find $m\angle RPQ$

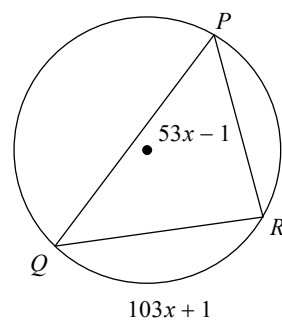

847) Find $m\angle BDC$

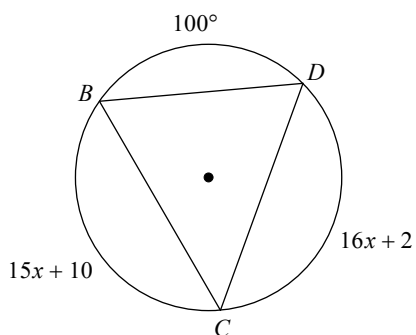

848) Find $m\angle KED$

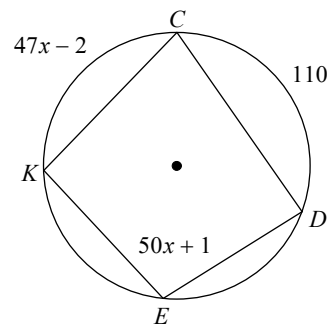

849) Find $m\angle PYX$

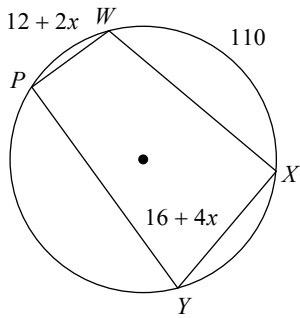

850) Find $m\angle ACB$

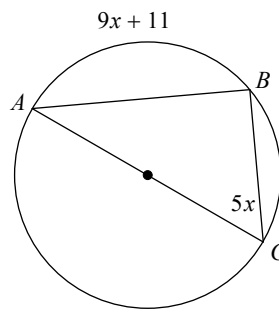

851) Find $m\angle HYX$

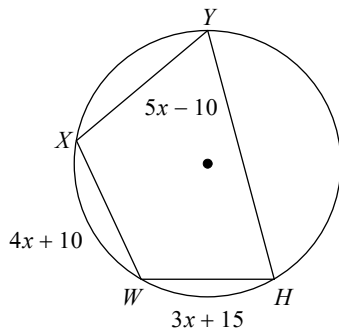

852) Find $m\angle YXZ$

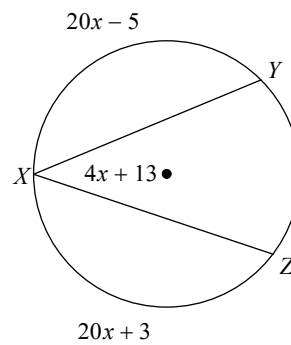

853) Find $m\angle RQS$

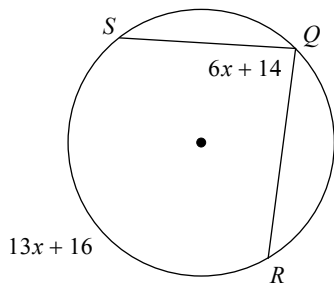

854) Find $m\angle YXZ$

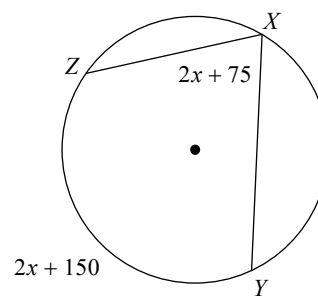

855) Find $m\angle KLJ$

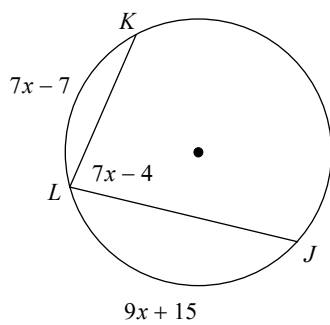

856) Find $m\angle HFG$

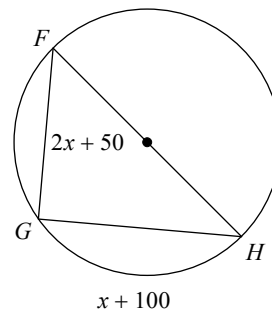

857) Find $m\angle FWX$

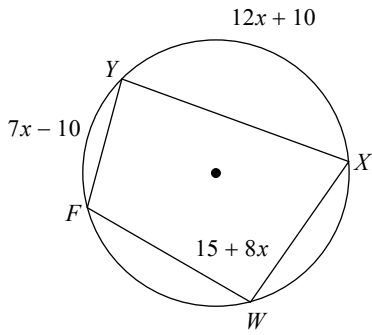

858) Find $m\angle TRS$

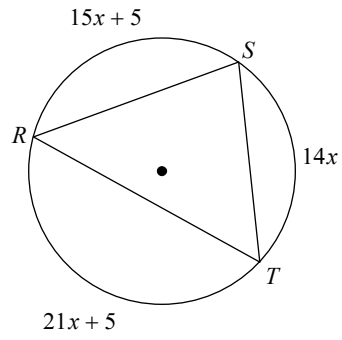

859) Find $m\angle EDF$

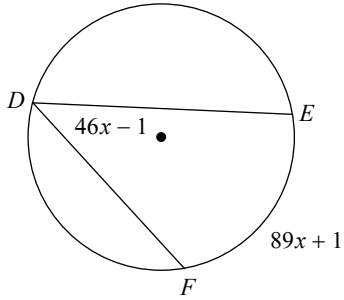

860) Find $m\angle YWX$

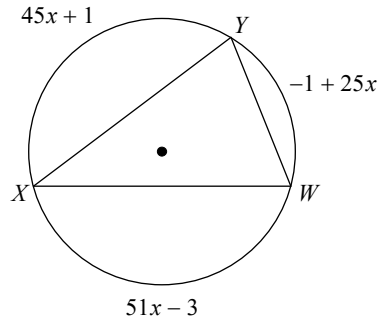

861) Find $m\angle FHG$

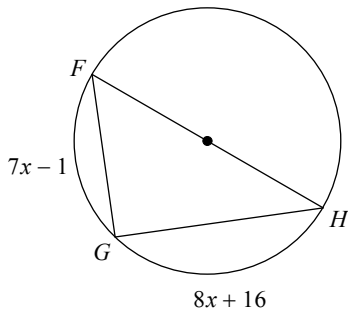

862) Find $m\angle LKM$

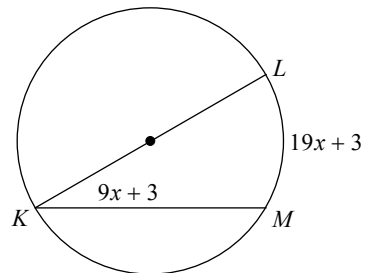

863) Find $m\angle BGD$

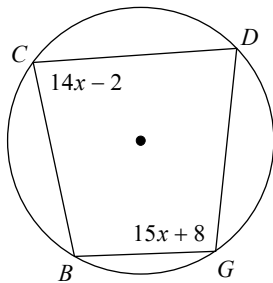

864) Find $m\angle RTS$

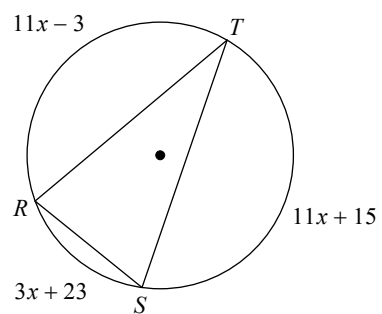

865) Find $m\angle RDS$

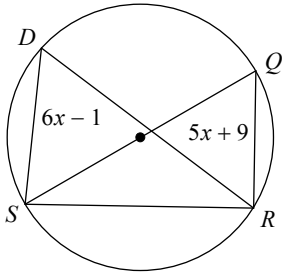

866) Find $m\angle CAB$

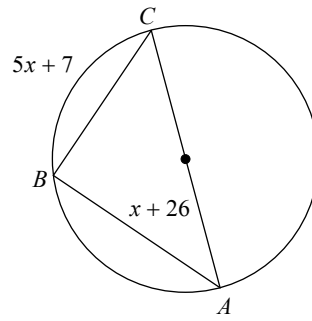

Find the angle measure by solving the system of equations

867)

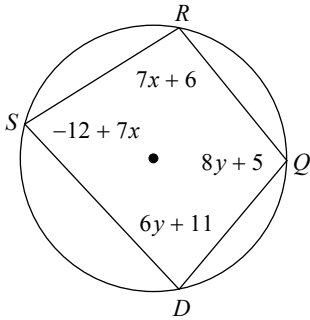

868)

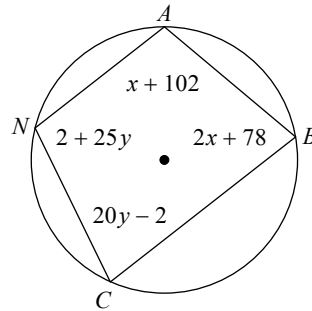

869)

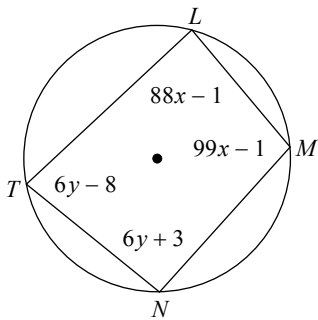

870)

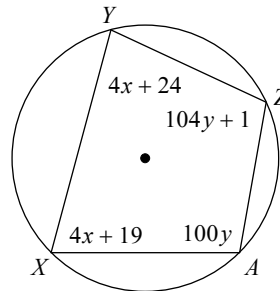

871)

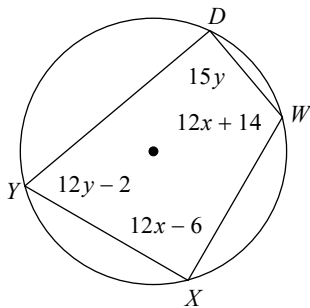

872)

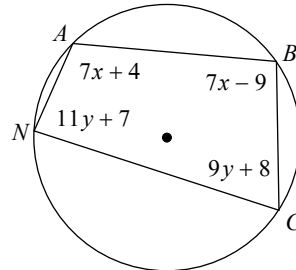

873)

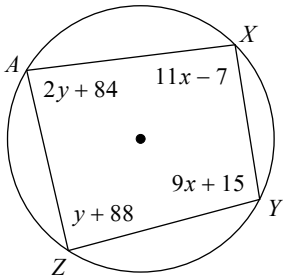

874)

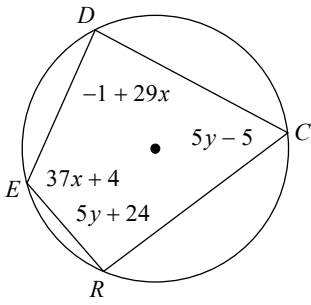

875)

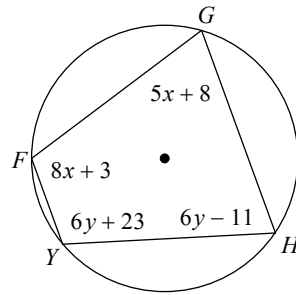

876)

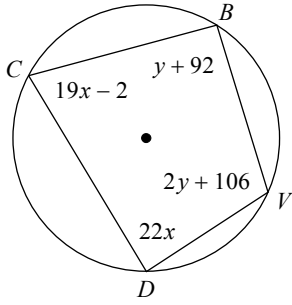

877)

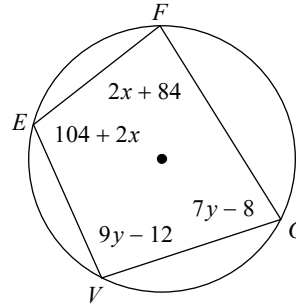

878)

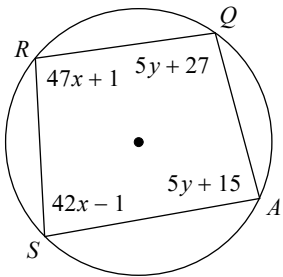

879)

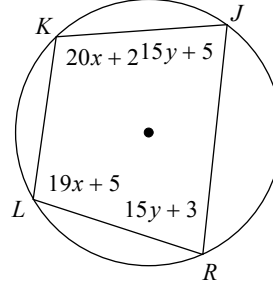

880)

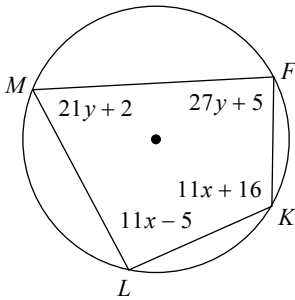

881)

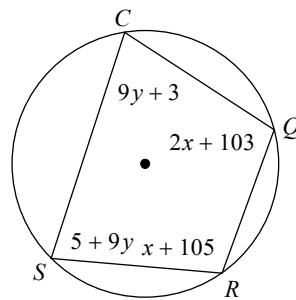

882)

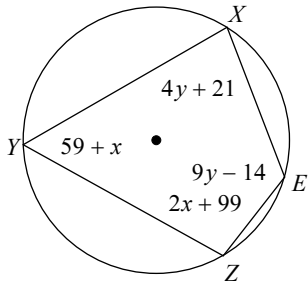

883)

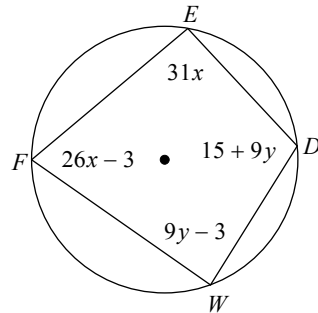

884)

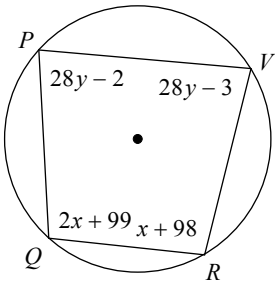

885)

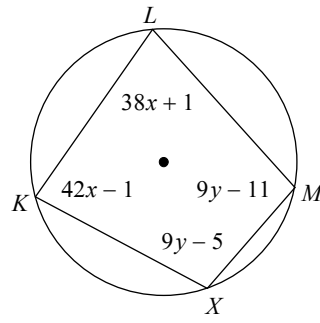

886)

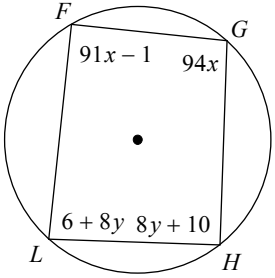

887)

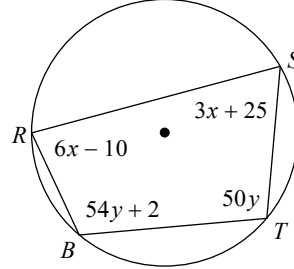

888)

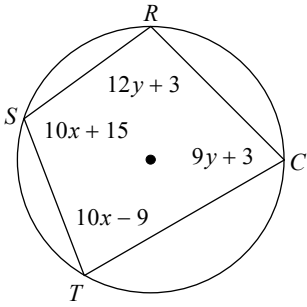

889)

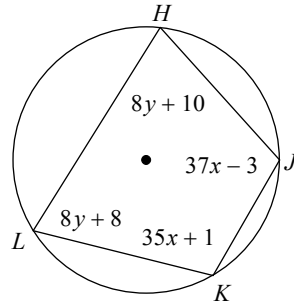

890)

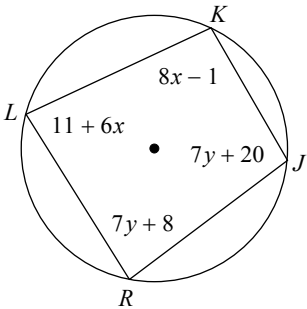

891)

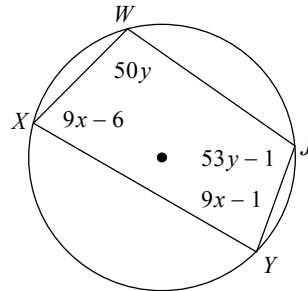

892)

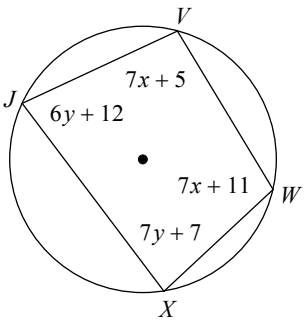

893)

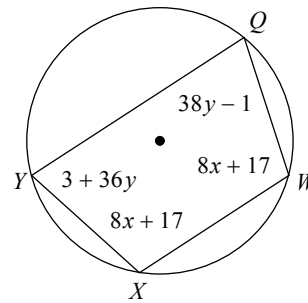

894)

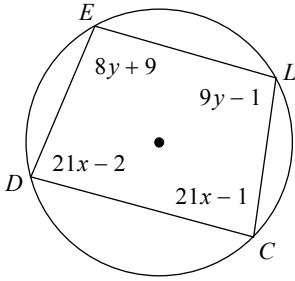

895)

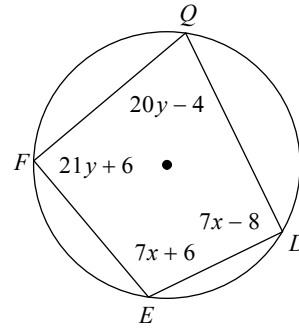

896)

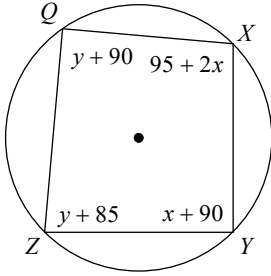

897)

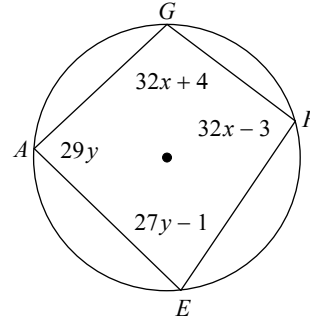

898)

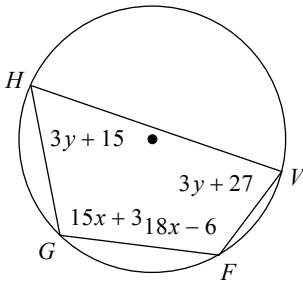

899)

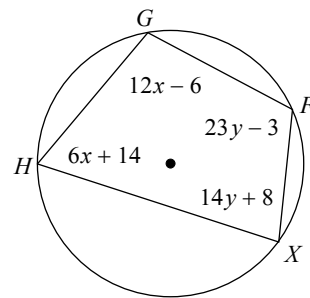

900)

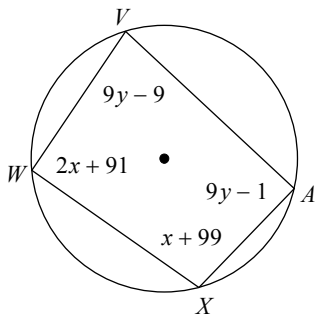

901)

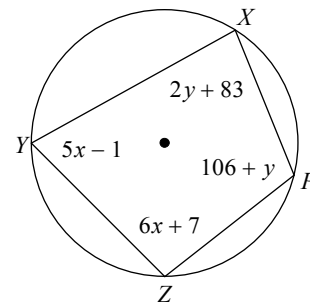

902)

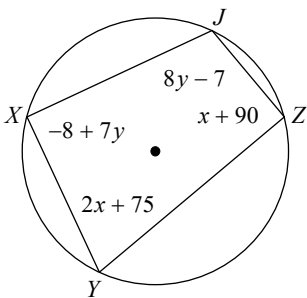

903)

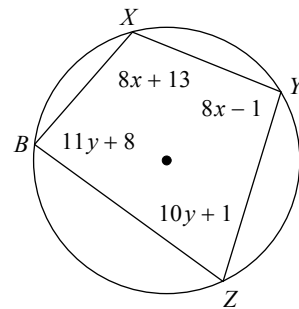

904)

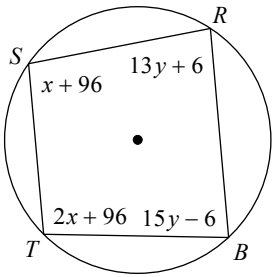

905)

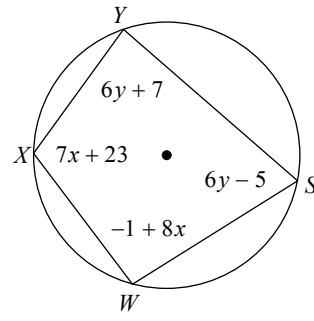

906)

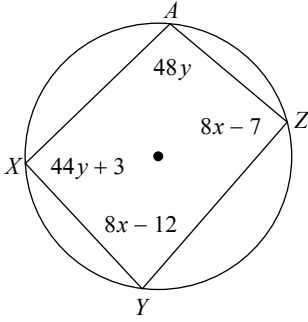

907)

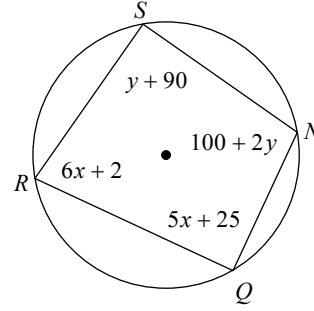

908)

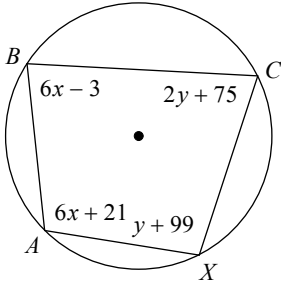

909)

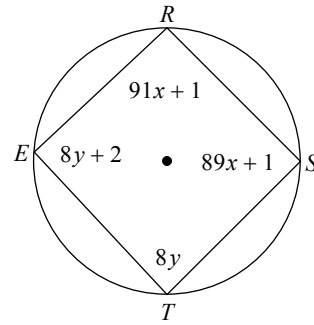

910)

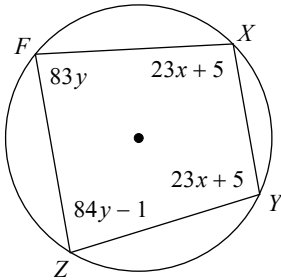

911)

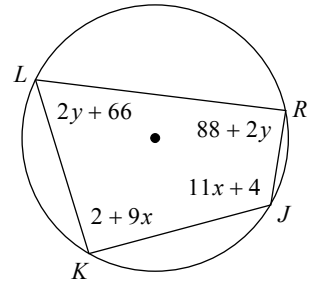

912)

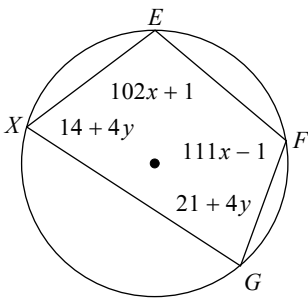

Circle - Inscribed angles

Decide if angle is inscribed and name the central angle and the arc between

1)

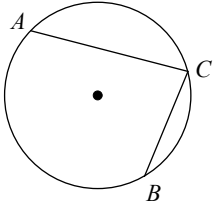

Yes; $m\angle BCA$, \widehat{BA}

2)

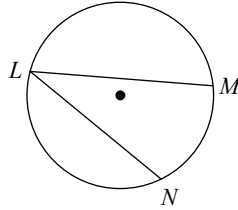

Yes; $m\angle MLN$, \widehat{MN}

3)

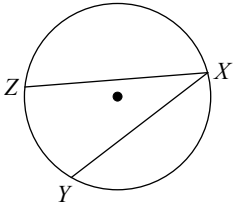

Yes; $m\angle YXZ$, \widehat{YZ}

4)

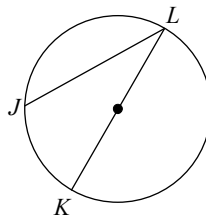

Yes; $m\angle KLJ$, \widehat{KJ}

5)

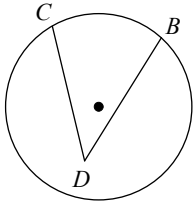

No

6)

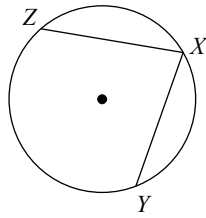

Yes; $m\angle YXZ, \widehat{YZ}$

7)

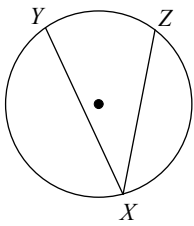

Yes; $m\angle YXZ, \widehat{YZ}$

8)

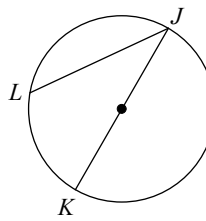

Yes; $m\angle KJL, \widehat{KL}$

9)

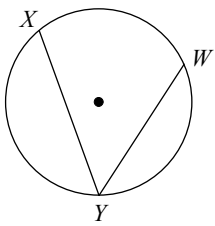

Yes; $m\angle XYW, \widehat{XW}$

10)

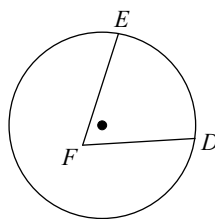

No

11)

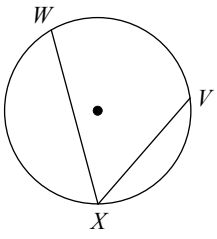

Yes; $m\angle WXV, \widehat{WV}$

12)

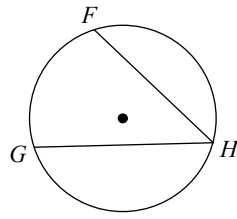

Yes; $m\angle GHF, \widehat{GF}$

13)

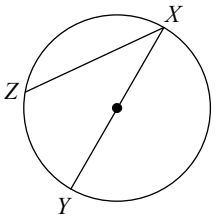

Yes; $m\angle YXZ, \widehat{YZ}$

14)

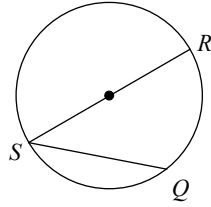

Yes; $m\angle RSQ, \widehat{RQ}$

15)

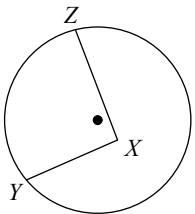

No

16)

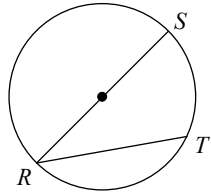

Yes; $m\angle SRT, \widehat{ST}$

17)

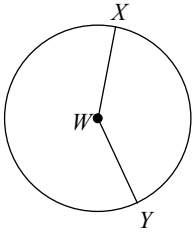

No

18)

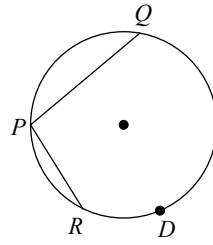

Yes; $m\angle QPR, \widehat{QDR}$

19)

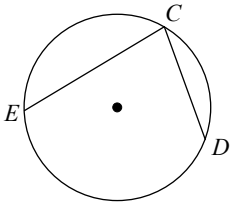

Yes; $m\angle DCE, \widehat{DE}$

20)

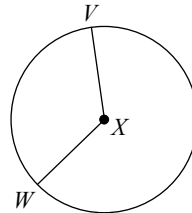

No

21)

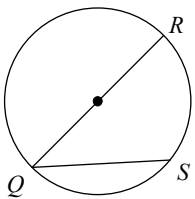

Yes; $m\angle RQS, \widehat{RS}$

22)

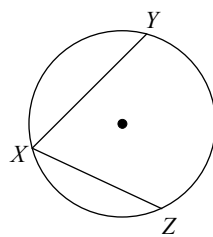

Yes; $m\angle YXZ, \widehat{YZ}$

23)

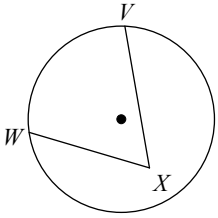

No

24)

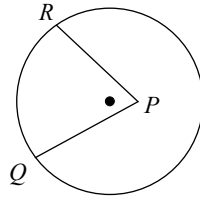

No

25)

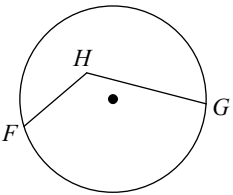

No

26)

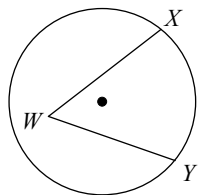

No

27)

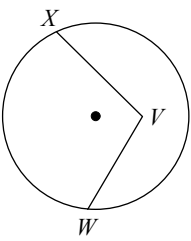

No

28)

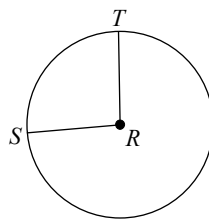

No

29)

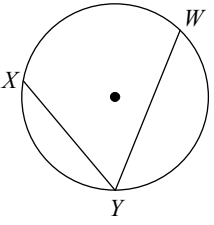

Yes; $m\angle XYW, \widehat{XW}$

30)

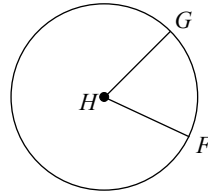

No

31)

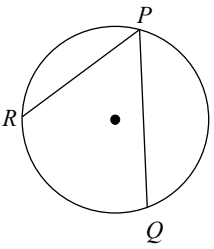

Yes; $m\angle QPR, \widehat{QR}$

32)

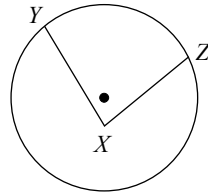

No

33)

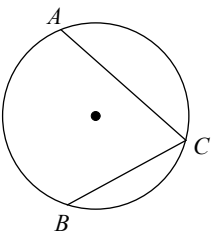

Yes; $m\angle BCA, \widehat{BA}$

34)

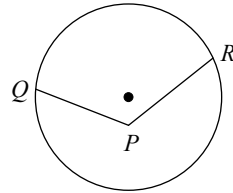

No

35)

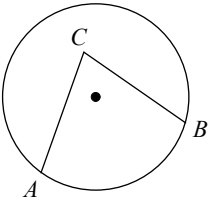

No

36)

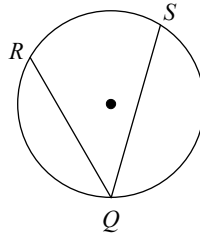

Yes; $m\angle RQS, \widehat{RS}$

37)

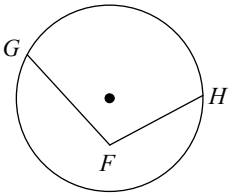

No

38)

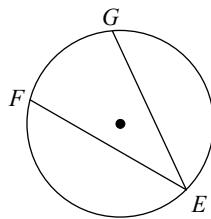

Yes; $m\angle FEG, \widehat{FG}$

39)

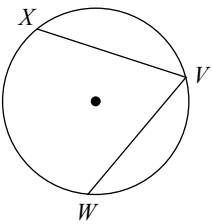

Yes; $m\angle WVX, \widehat{WX}$

40)

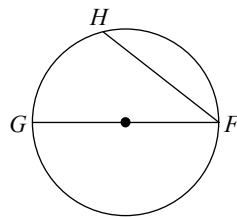

Yes; $m\angle GFH, \widehat{GH}$

41)

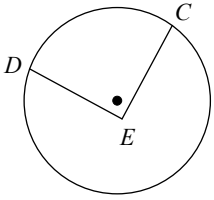

No

42)

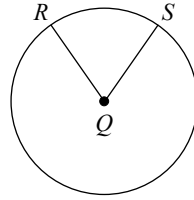

No

43)

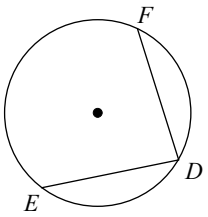

Yes; $m\angle EDF, \widehat{EF}$

44)

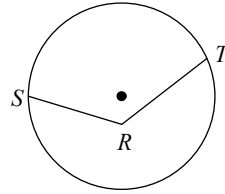

No

45)

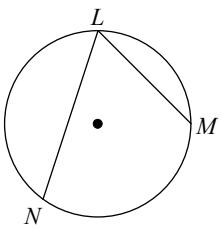

Yes; $m\angle MLN, \widehat{MN}$

46)

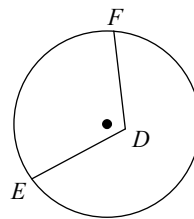

No

47)

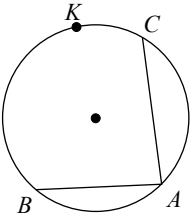

Yes; $m\angle BAC, \widehat{BKC}$

48)

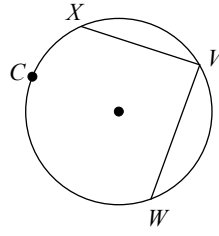

Yes; $m\angle VWX, \widehat{WCX}$

49)

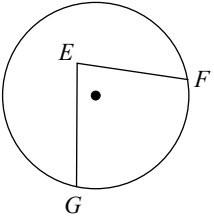

No

50)

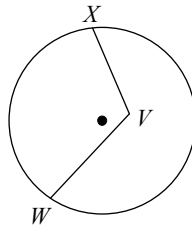

No

51)

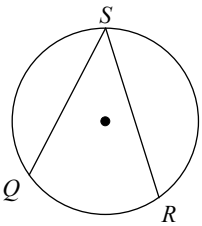

Yes; $m\angle RSQ, \widehat{RQ}$

52)

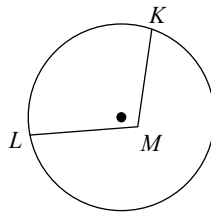

No

53)

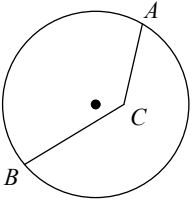

No

54)

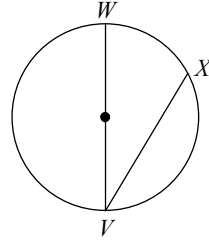

Yes; $m\angle WVX, \widehat{WX}$

55)

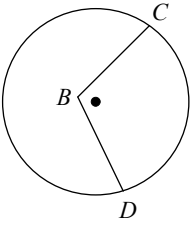

No

56)

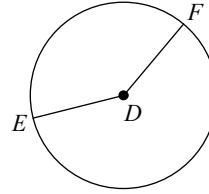

No

57)

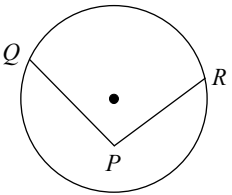

No

58)

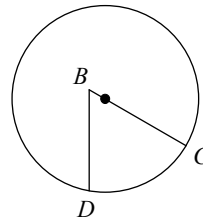

No

59)

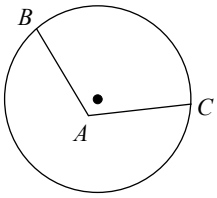

No

60)

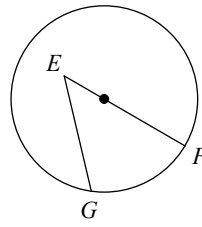

No

Find the measure of inscribed angle

61)

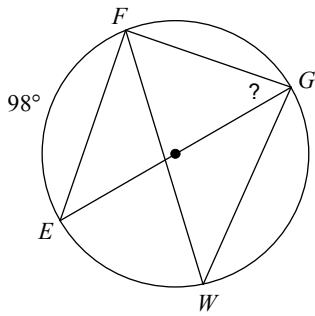

49°

62)

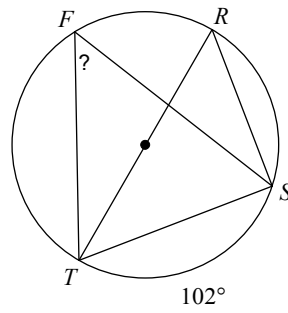

51°

63)

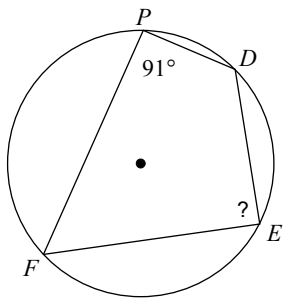

89°

64)

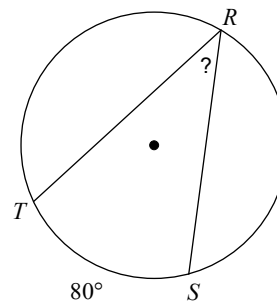

40°

65)

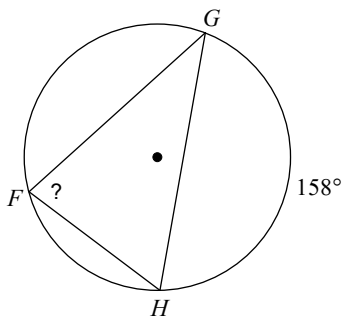

79°

66)

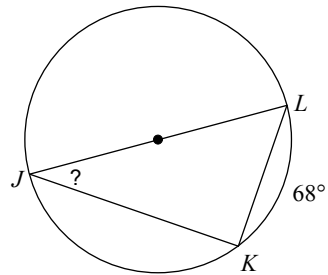

34°

67)

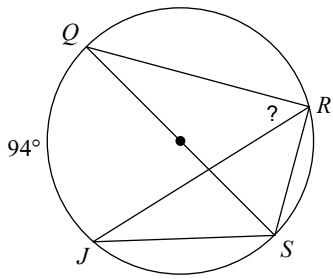

47°

68)

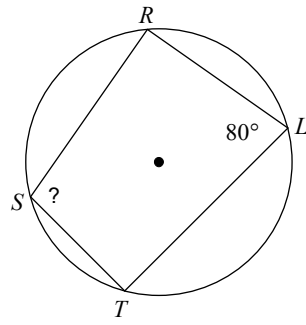

100°

69)

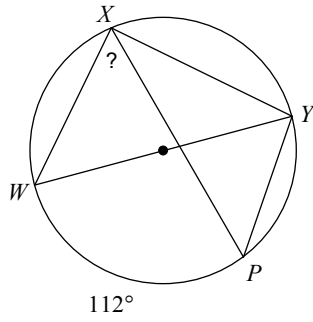

56°

70)

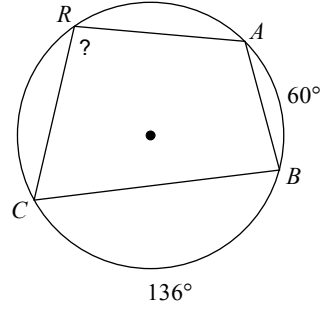

98°

71)

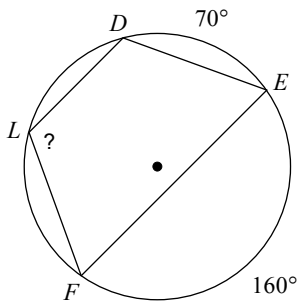

115°

72)

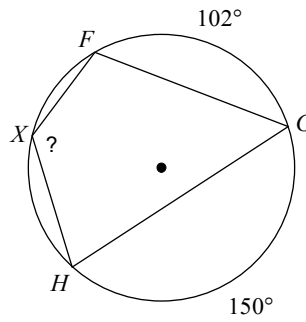

126°

73)

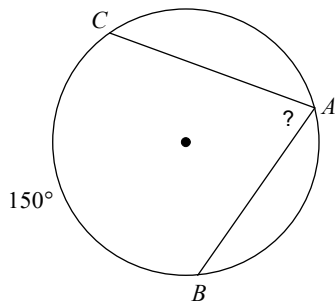

75°

74)

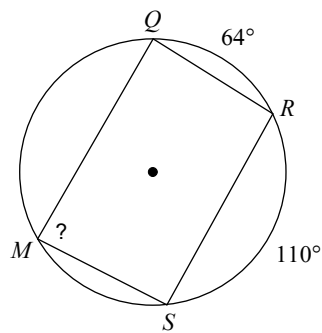

87°

75)

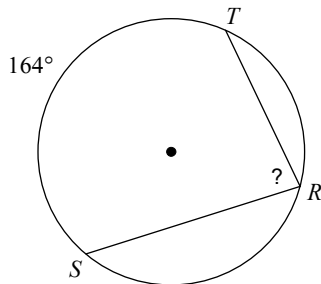

82°

76)

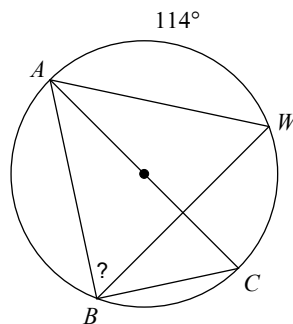

57°

77)

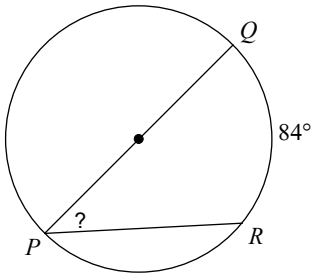

42°

78)

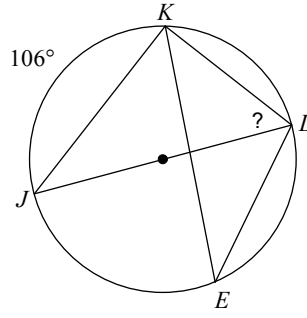

53°

79)

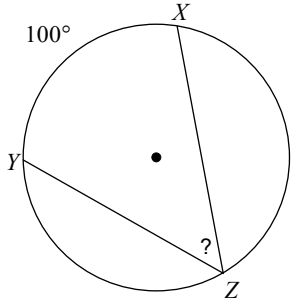

50°

80)

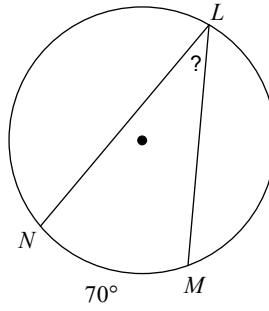

35°

81)

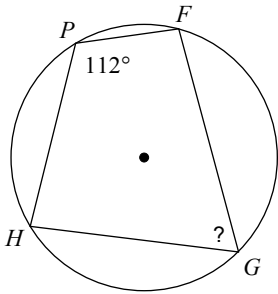

68°

82)

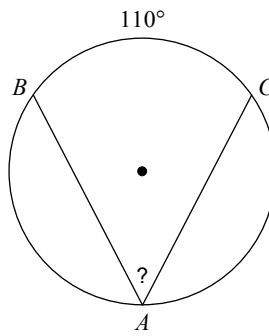

55°

83)

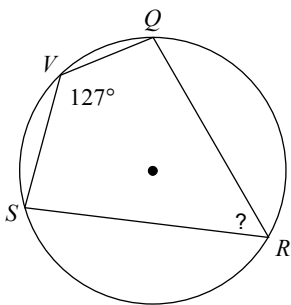

53°

84)

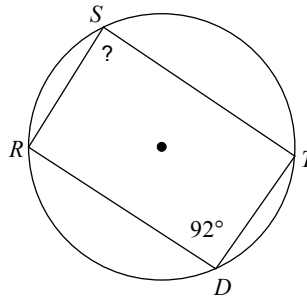

88°

85)

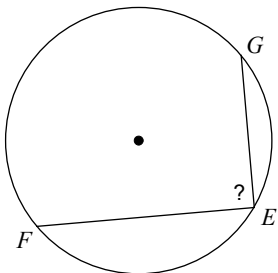

90°

86)

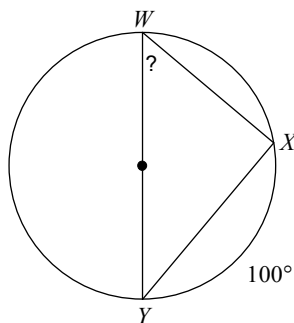

50°

87)

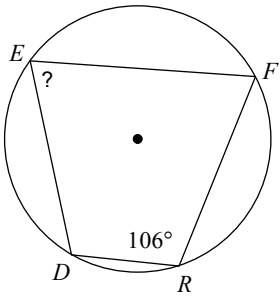

74°

88)

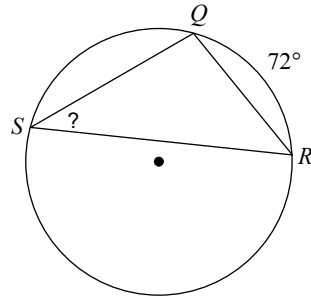

36°

89)

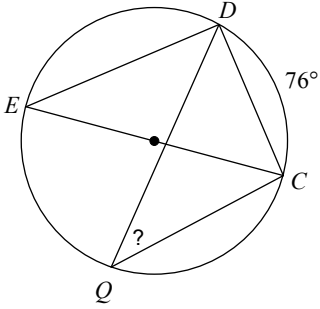

38°

90)

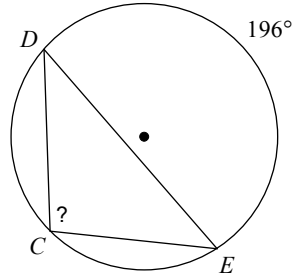

98°

91)

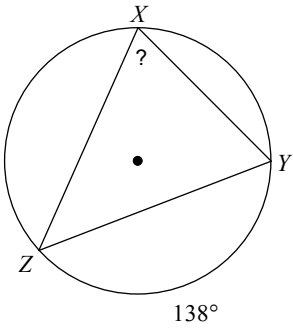

69°

92)

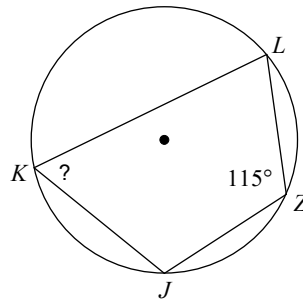

65°

93)

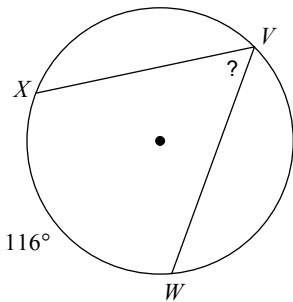

58°

94)

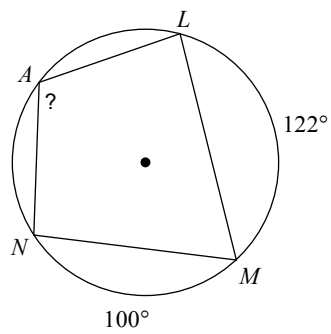

111°

95)

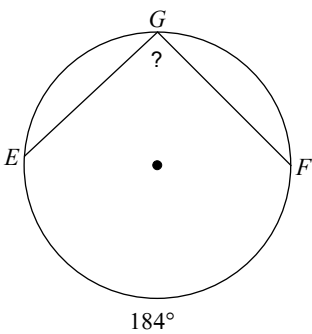

92°

96)

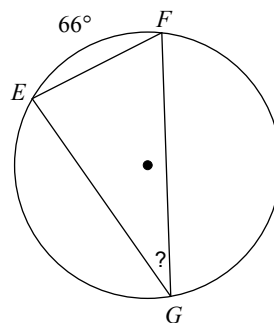

33°

97)

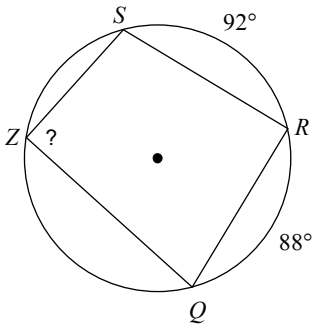

90°

98)

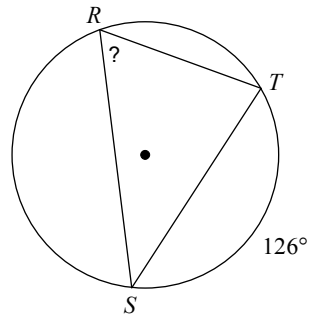

63°

99)

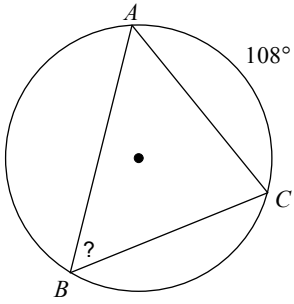

54°

100)

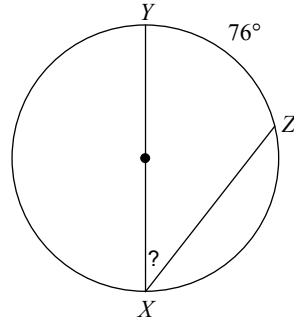

38°

101)

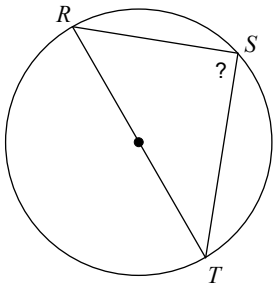

90°

102)

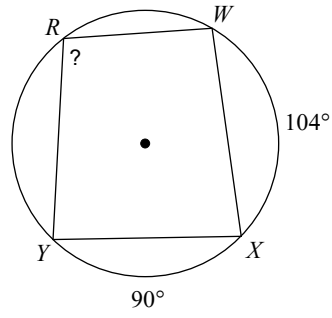

97°

103)

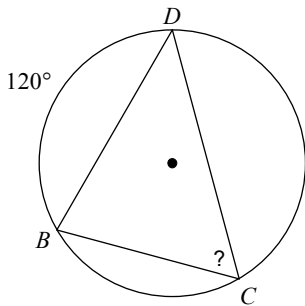

60°

104)

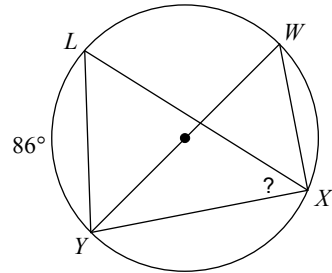

43°

105)

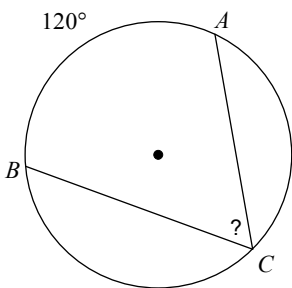

60°

106)

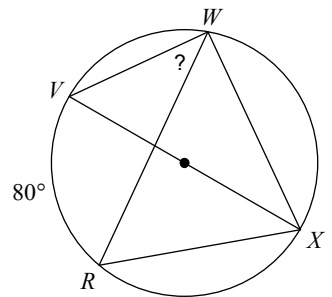

40°

107)

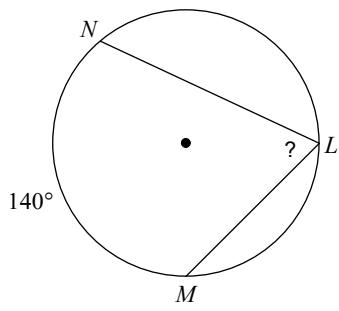

70°

108)

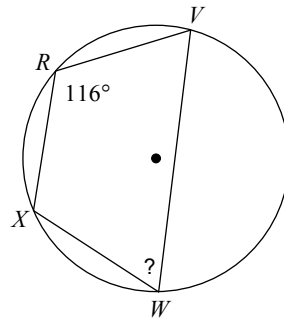

64°

109)

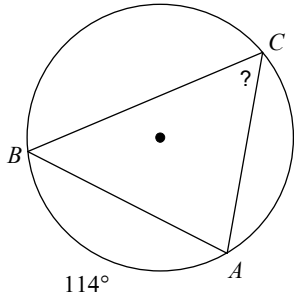

57°

110)

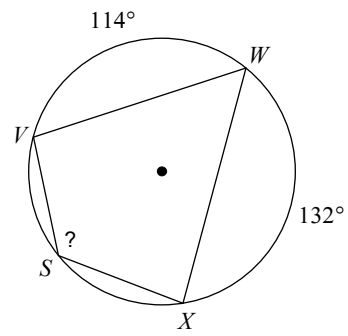

123°

111)

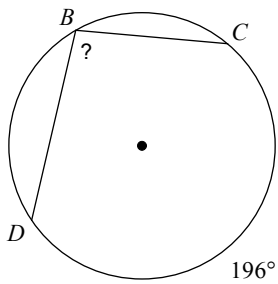

98°

112)

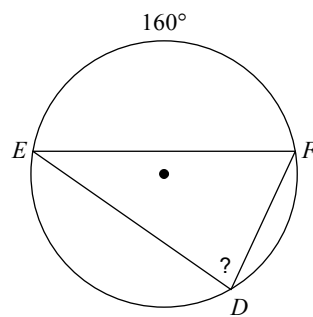

80°

113)

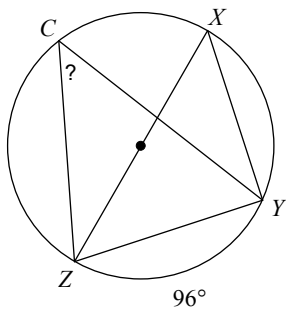

48°

114)

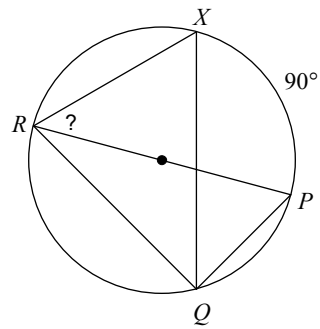

45°

115)

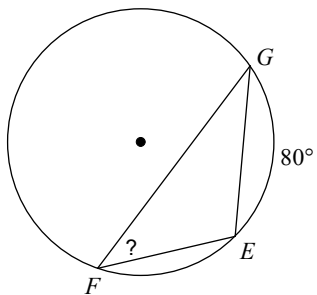

40°

116)

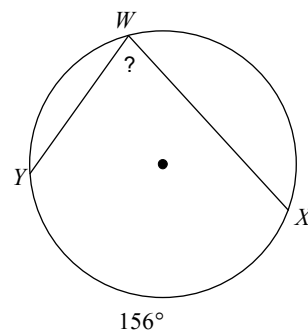

78°

117)

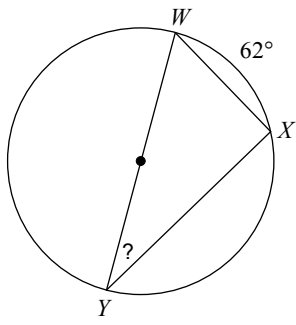

31°

118)

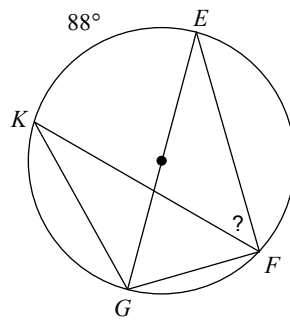

44°

119)

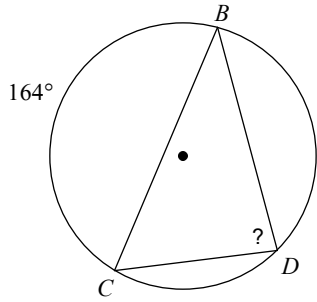

82°

120)

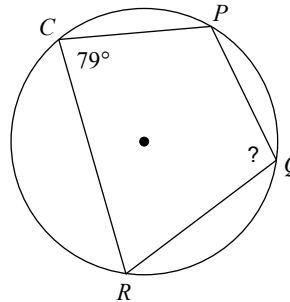

101°

121)

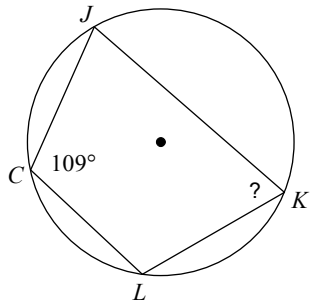

71°

122)

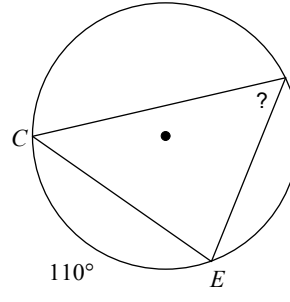

55°

123)

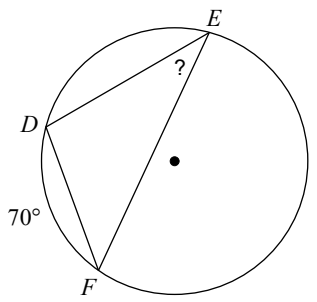

35°

124)

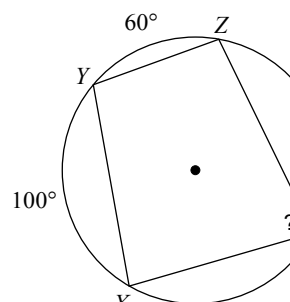

80°

125)

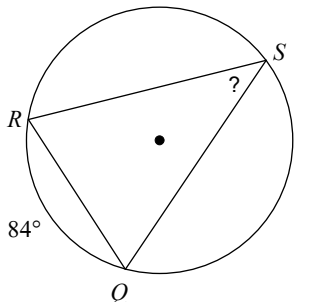

42°

126)

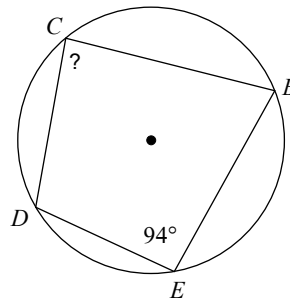

86°

127)

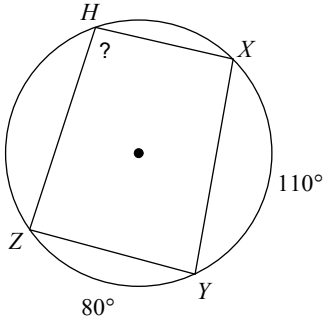

95°

128)

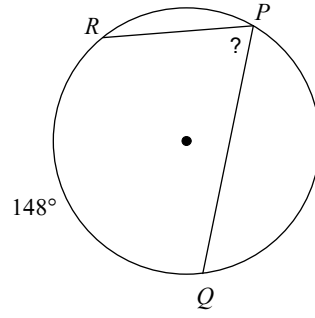

74°

129)

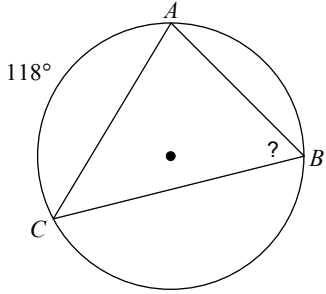

59°

130)

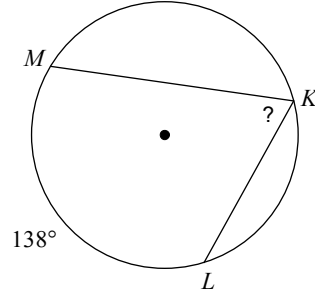

69°

131)

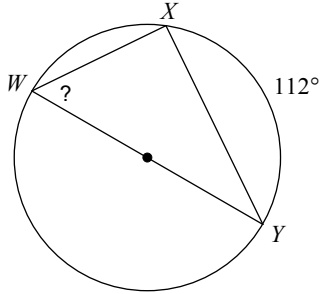

56°

132)

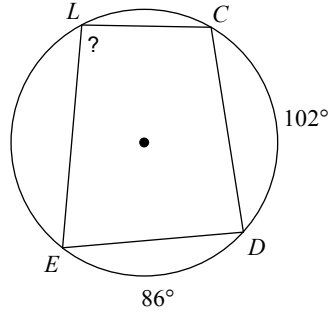

94°

133)

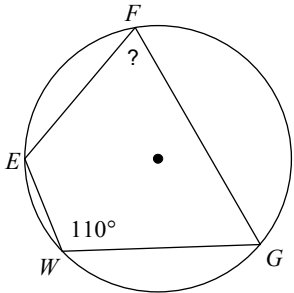

70°

134)

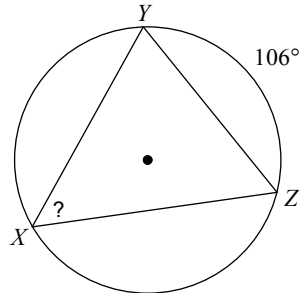

53°

135)

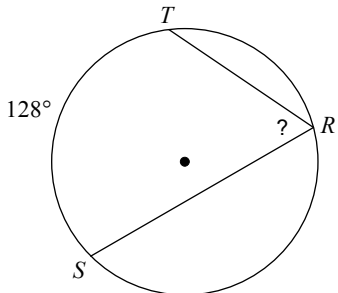

64°

136)

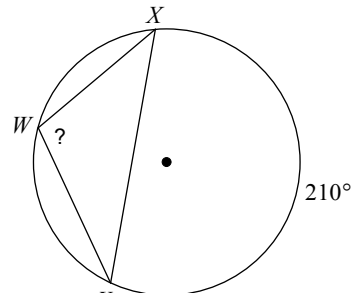

105°

137)

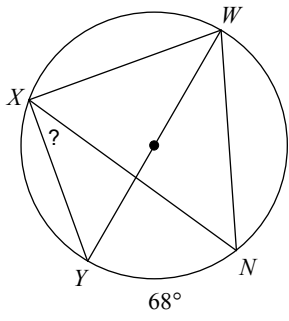

34°

138)

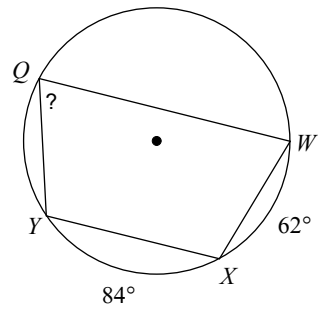

73°

139)

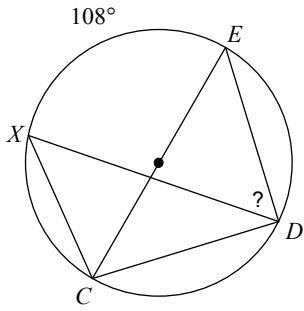

54°

140)

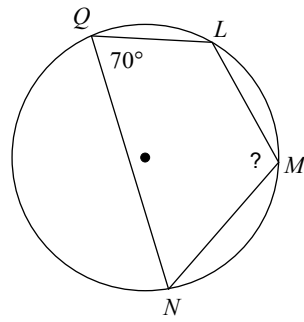

110°

141)

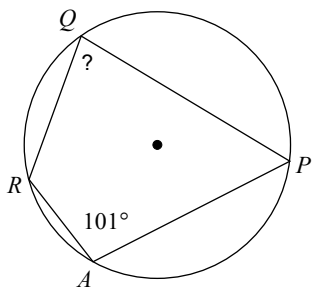

79°

142)

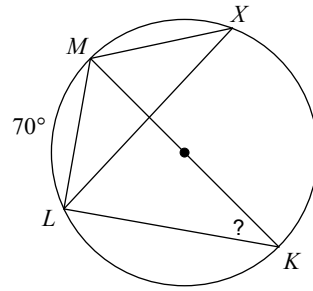

35°

143)

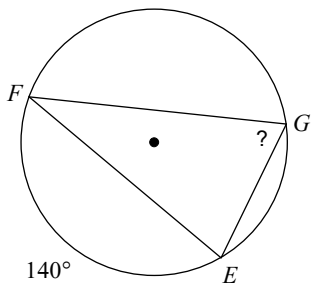

70°

144)

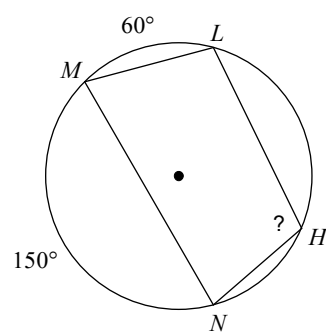

105°

145)

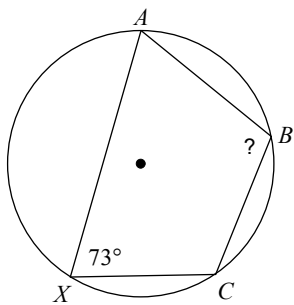

107°

146)

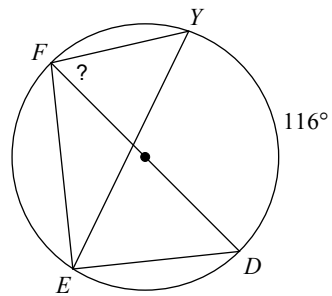

58°

147)

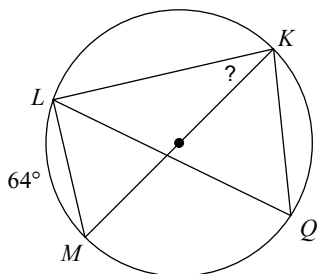

32°

148)

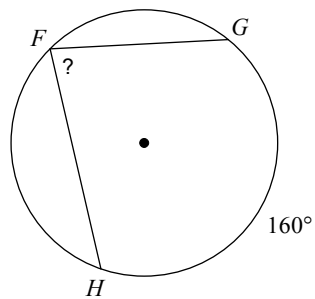

80°

149)

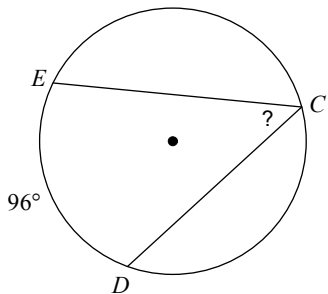

48°

150)

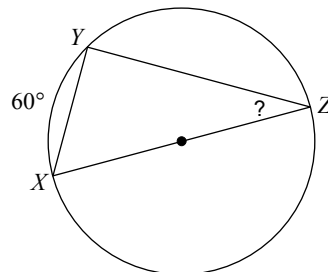

30°

151)

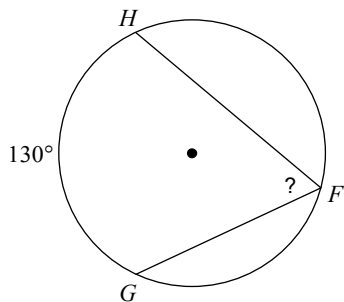

65°

152)

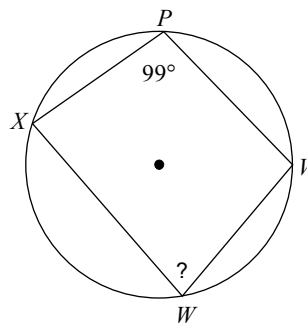

81°

153)

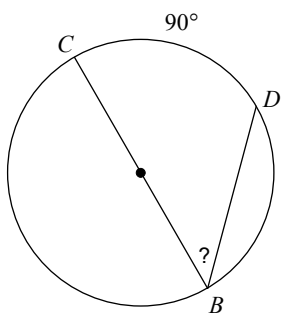

45°

154)

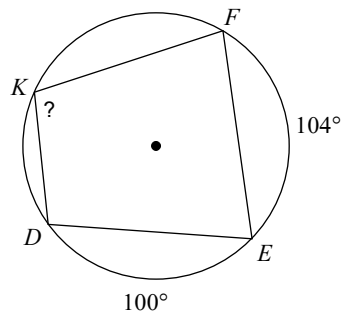

102°

155)

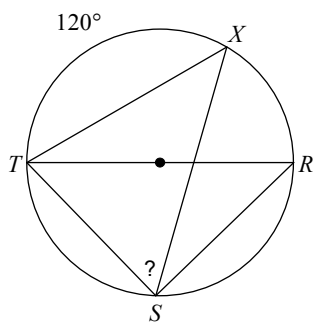

60°

156)

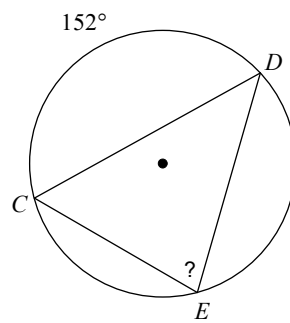

76°

157)

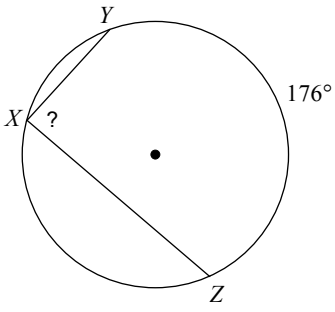

88°

158)

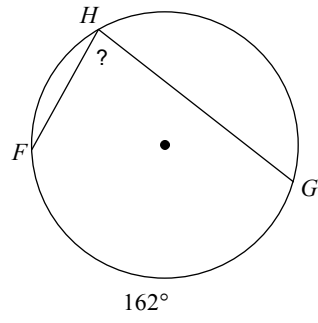

81°

159)

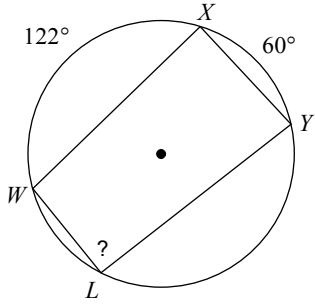

91°

160)

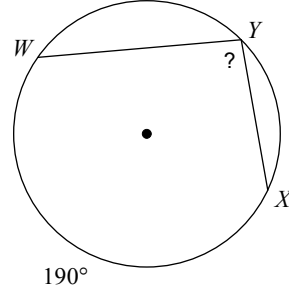

95°

161)

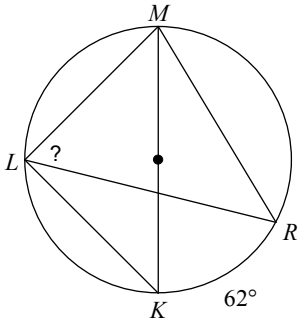

59°

162)

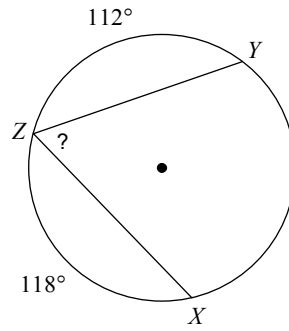

65°

163)

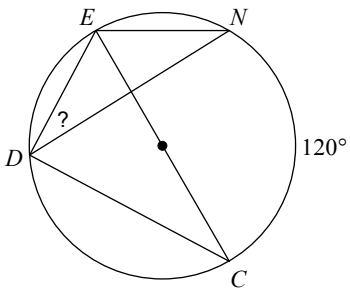

30°

164)

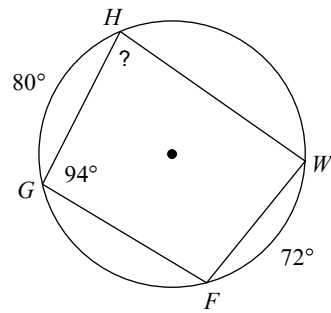

82°

165)

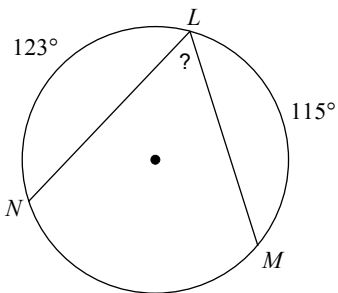

61°

166)

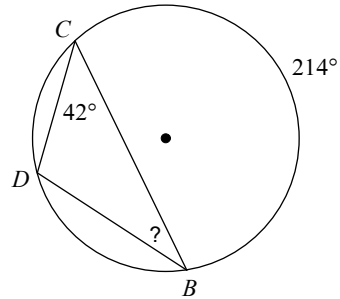

31°

167)

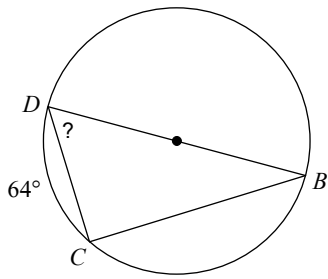

58°

168)

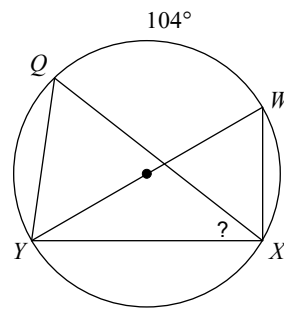

38°

169)

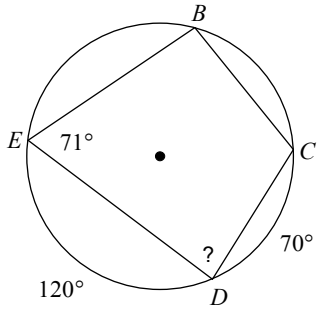

85°

170)

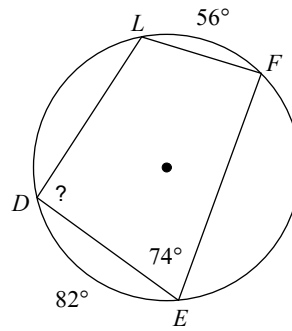

93°

171)

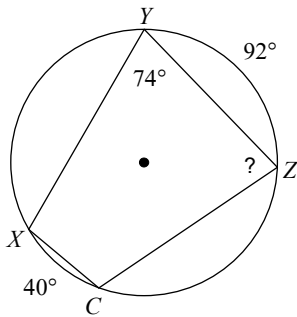

80°

172)

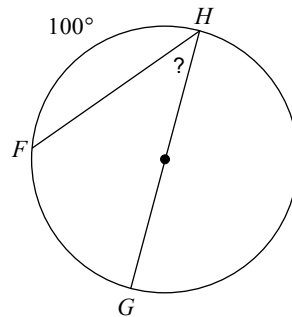

40°

173)

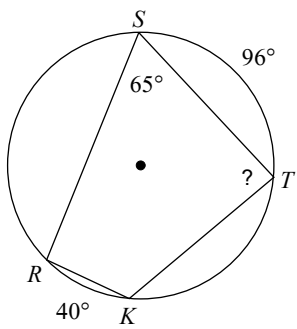

87°

174)

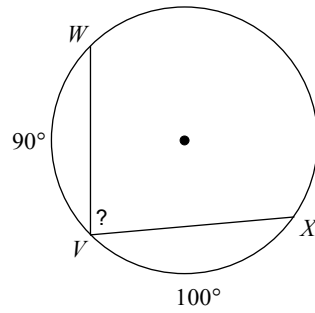

85°

175)

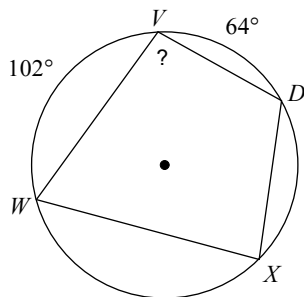

97°

176)

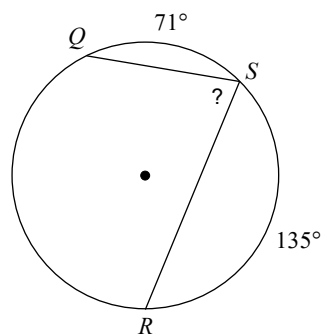

77°

177)

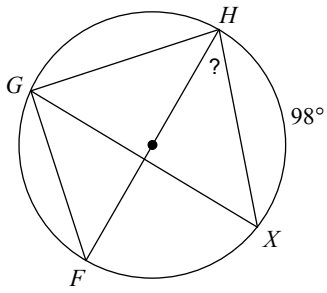

41°

178)

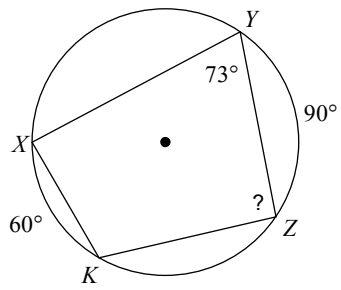

92°

179)

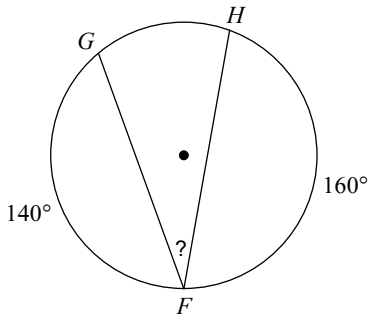

30°

180)

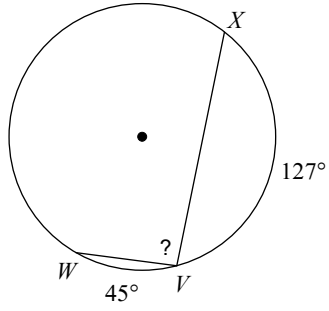

94°

181)

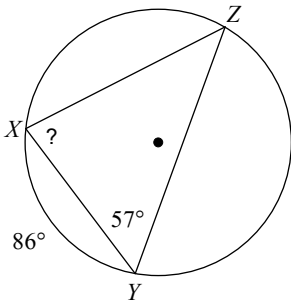

80°

182)

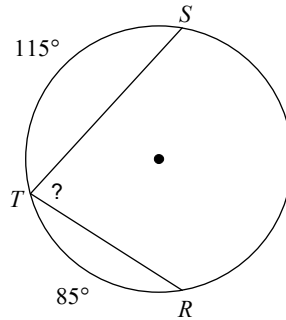

80°

183)

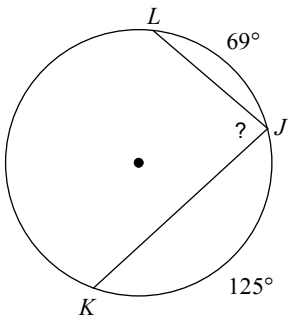

83°

184)

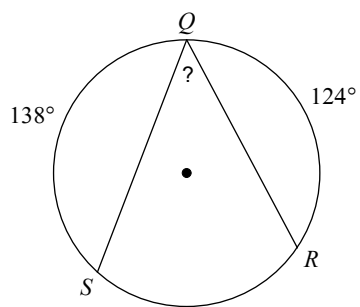

49°

185)

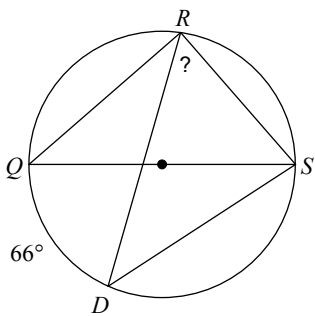

57°

186)

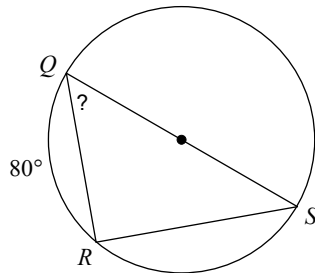

50°

187)

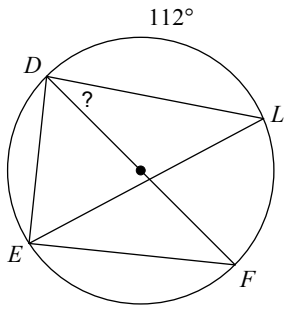

34°

188)

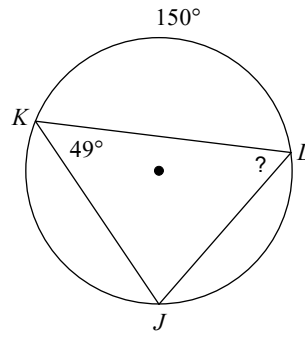

56°

189)

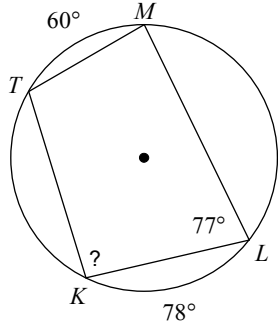

94°

190)

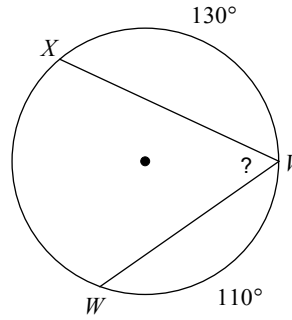

60°

191)

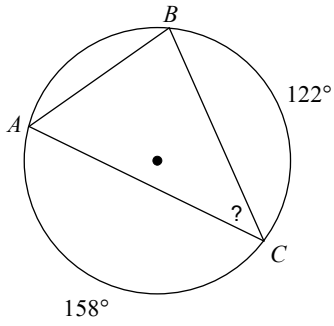

40°

192)

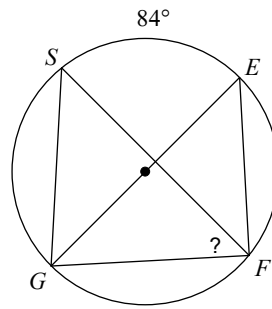

48°

193)

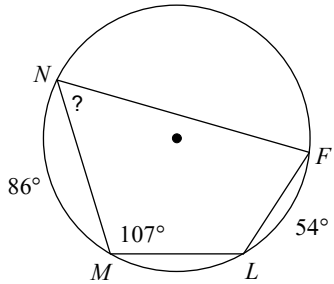

57°

194)

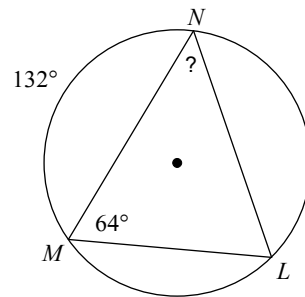

50°

195)

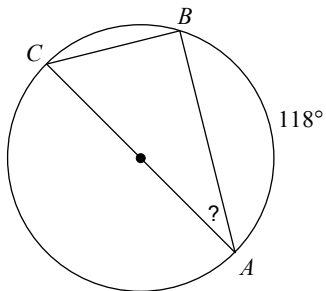

31°

196)

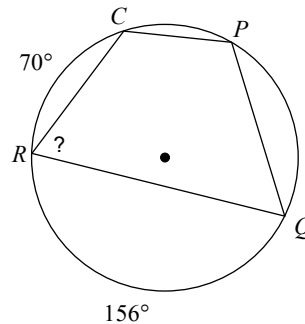

67°

197)

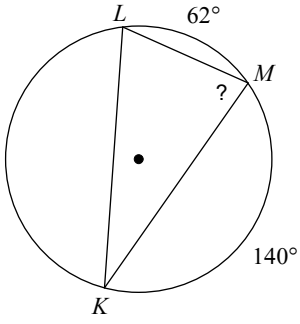

79°

198)

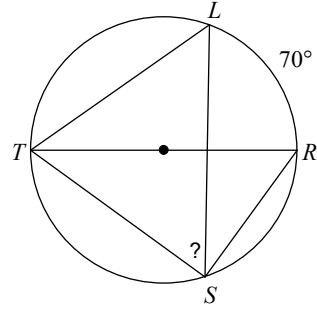

55°

199)

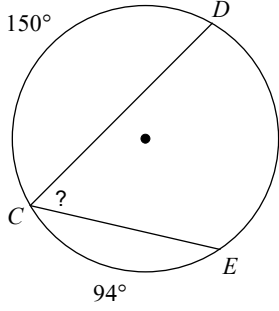

58°

200)

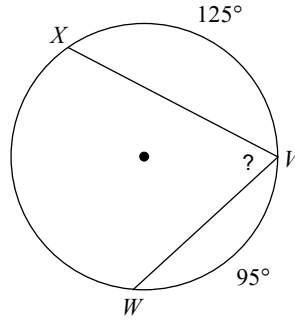

70°

201)

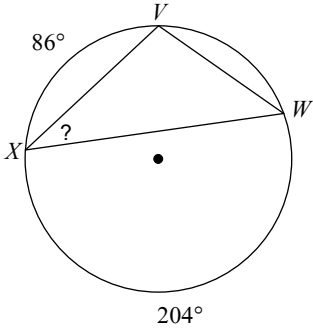

35°

202)

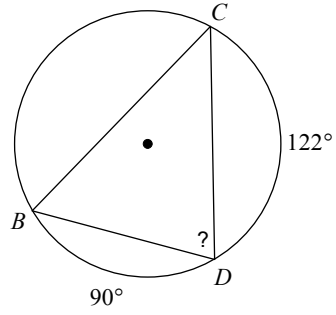

74°

203)

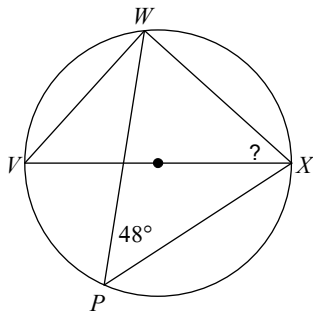

42°

204)

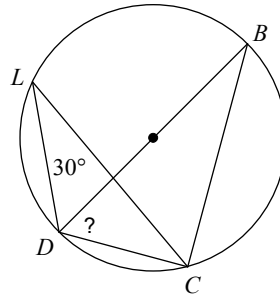

60°

205)

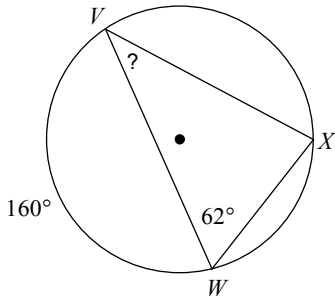

38°

206)

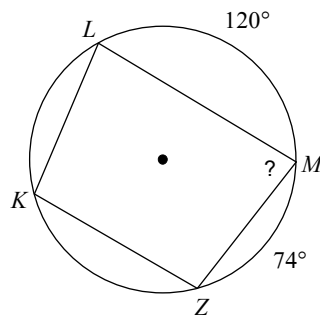

83°

207)

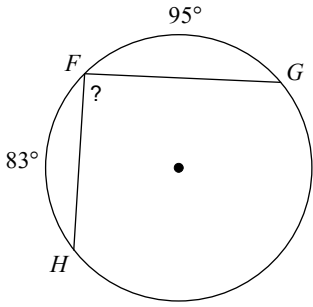

91°

208)

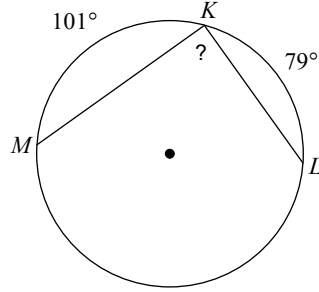

90°

209)

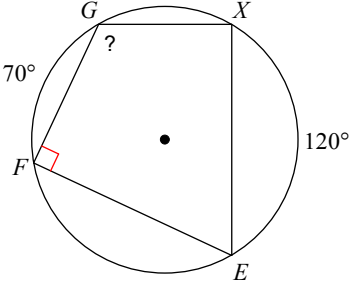

115°

210)

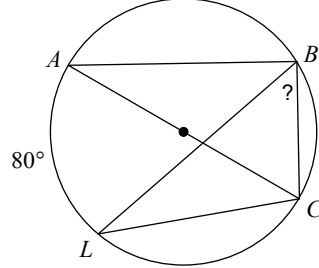

50°

211)

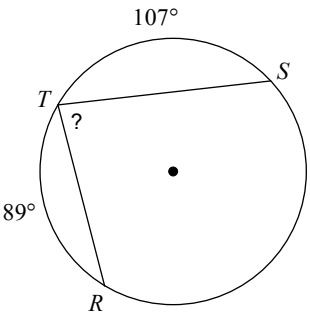

82°

212)

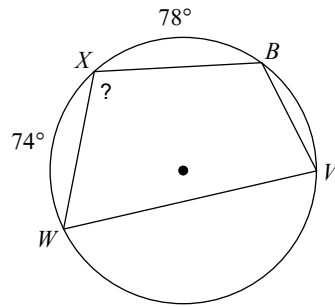

104°

213)

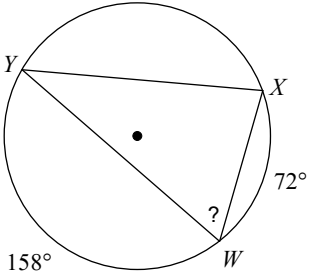

65°

214)

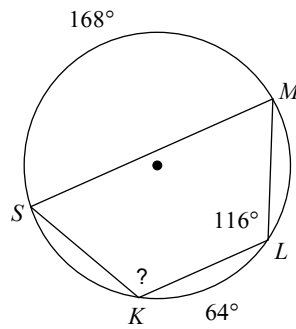

116°

215)

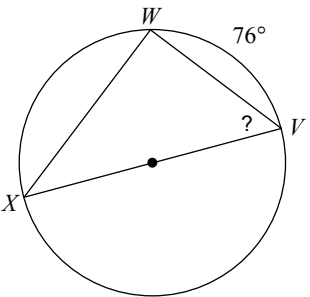

52°

216)

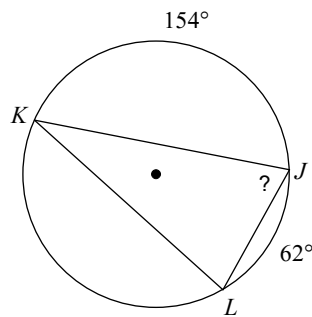

72°

217)

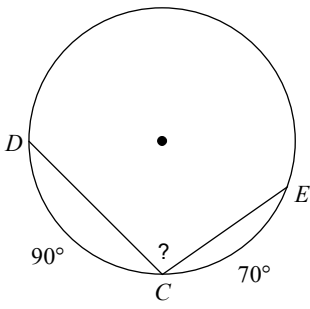

100°

218)

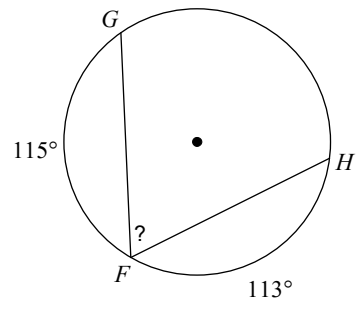

66°

219)

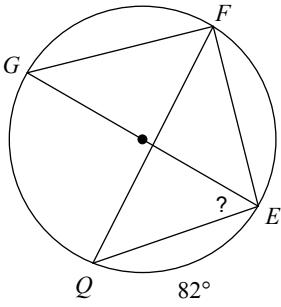

49°

220)

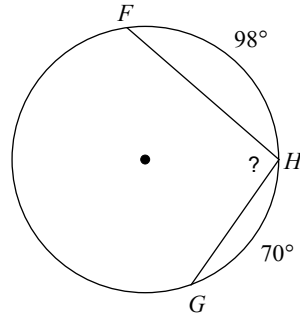

96°

221)

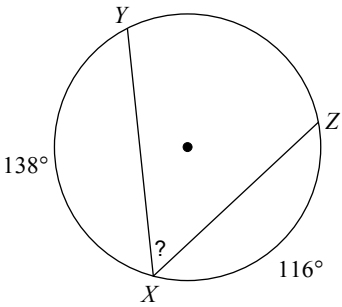

53°

222)

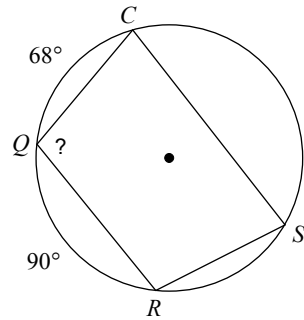

101°

223)

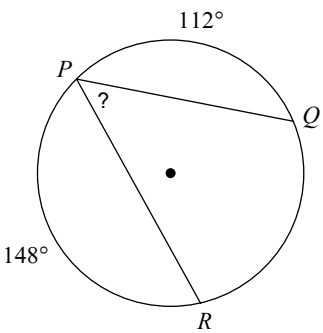

50°

224)

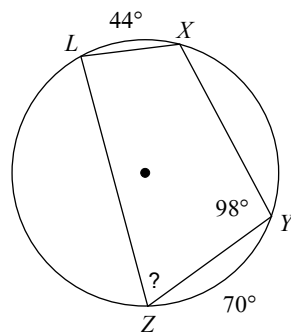

69°

225)

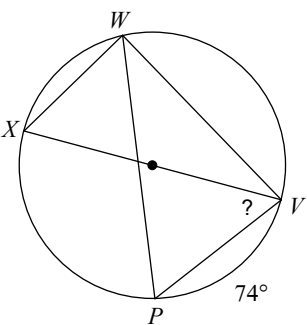

53°

226)

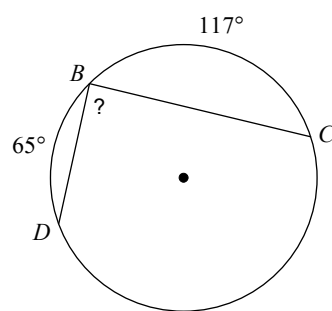

89°

227)

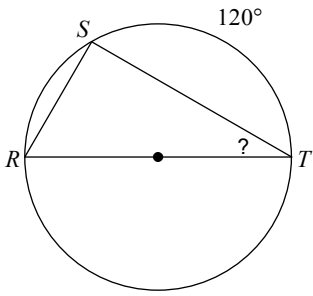

30°

228)

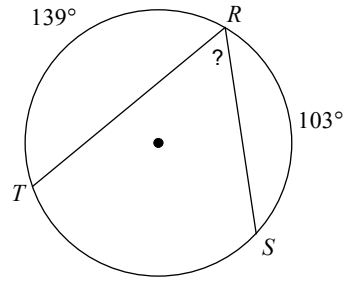

59°

229)

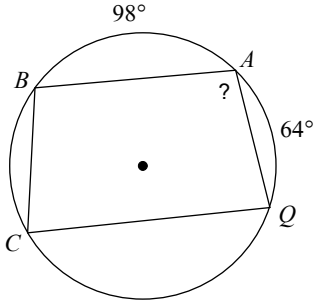

99°

230)

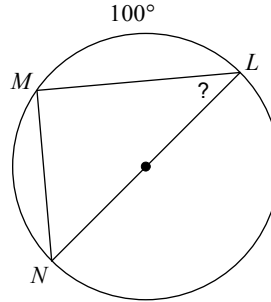

40°

231)

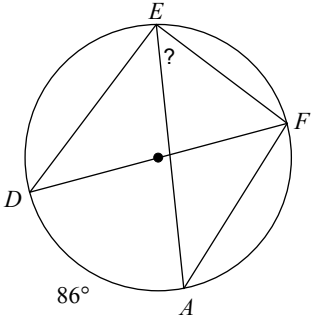

47°

232)

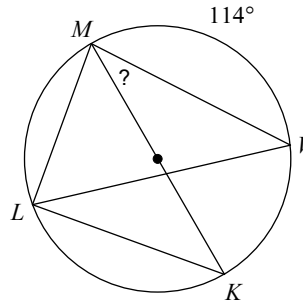

33°

233)

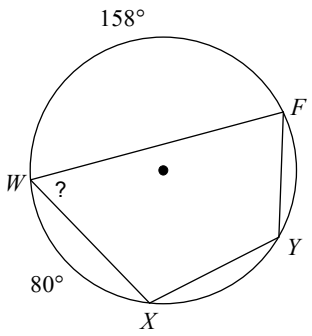

61°

234)

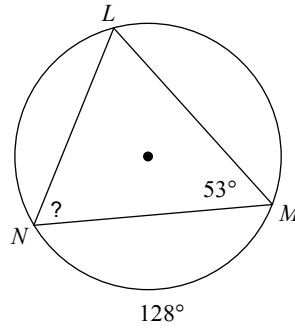

63°

235)

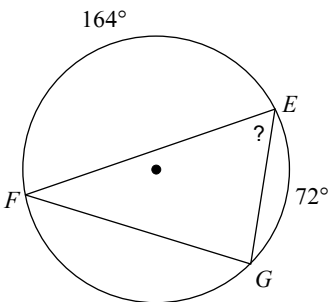

62°

236)

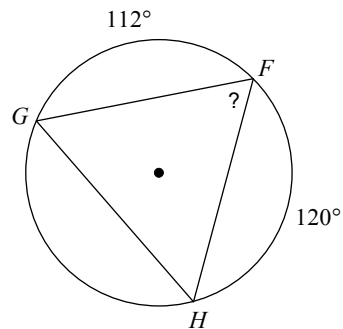

64°

237)

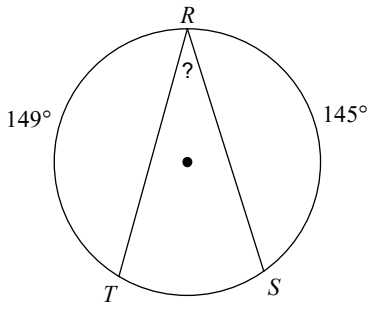

33°

238)

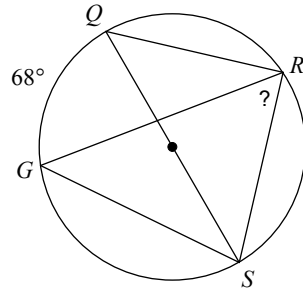

56°

239)

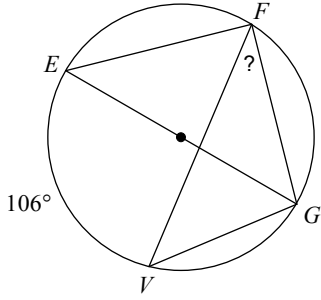

37°

240)

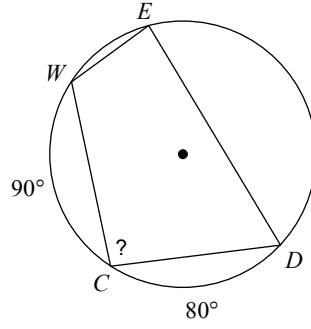

95°

241)

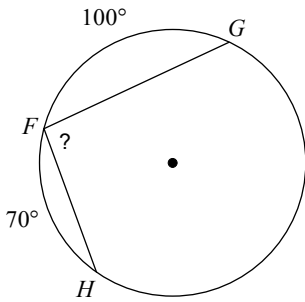

95°

242)

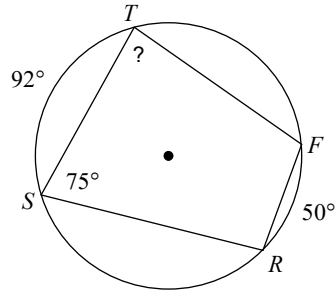

84°

243)

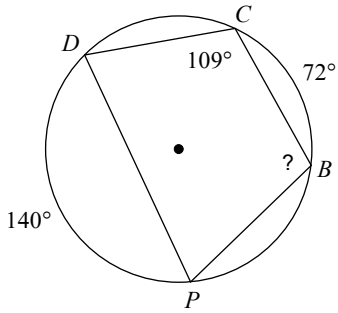

105°

244)

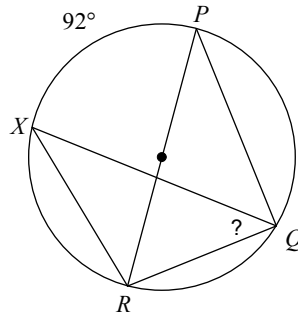

44°

245)

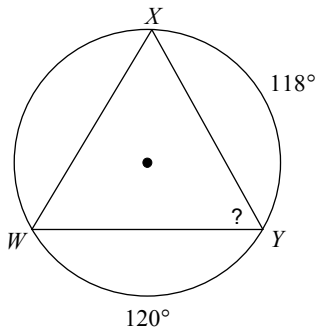

61°

246)

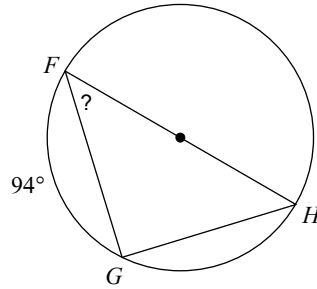

43°

247)

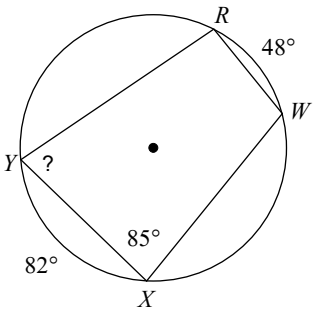

78°

248)

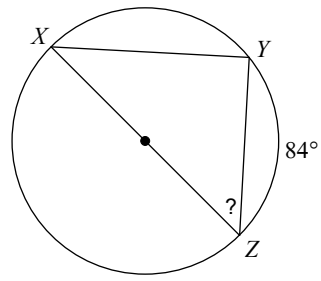

48°

249)

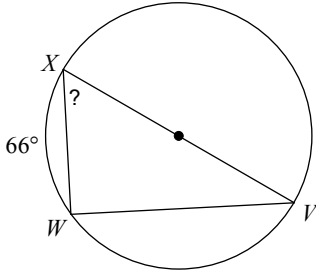

57°

250)

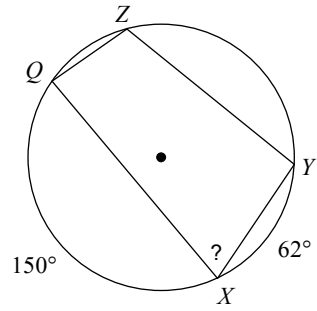

74°

251)

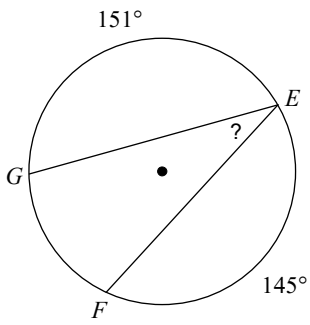

32°

252)

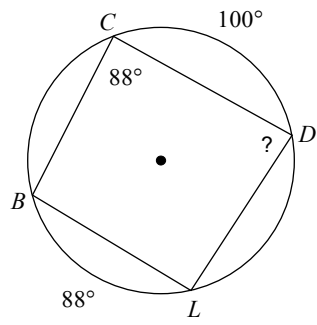

86°

253)

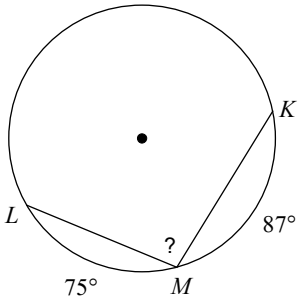

99°

254)

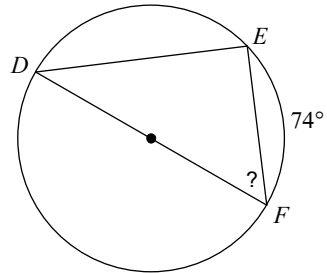

53°

255)

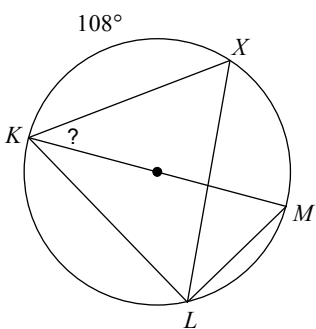

36°

256)

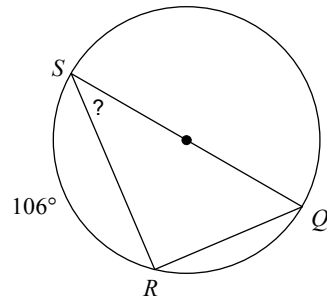

37°

257)

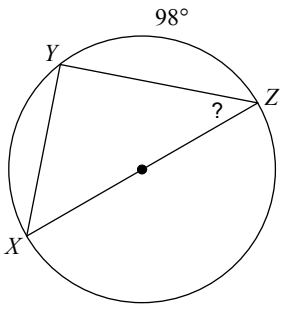

41°

258)

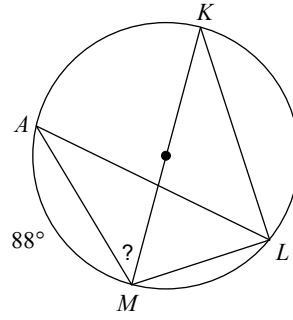

46°

259)

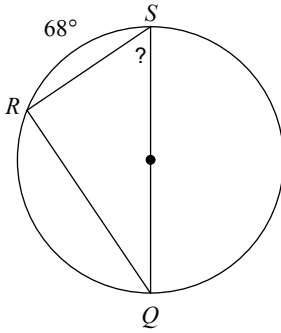

56°

260)

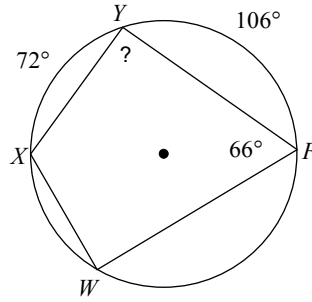

91°

Find the measure of the unknown arc

261) Find $m\widehat{FED}$

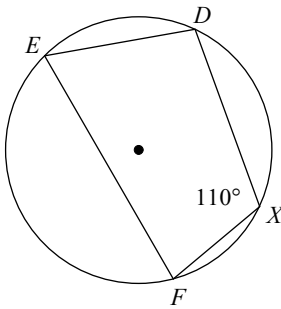

220°

262)

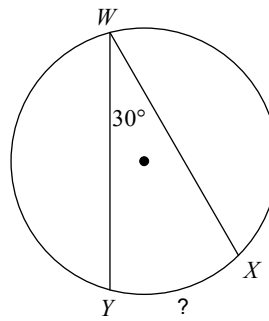

60°

263) Find $m\widehat{SRQ}$

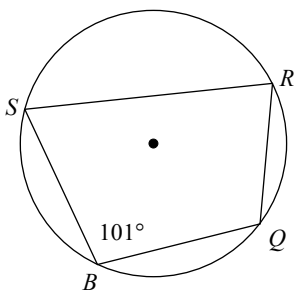

202°

264)

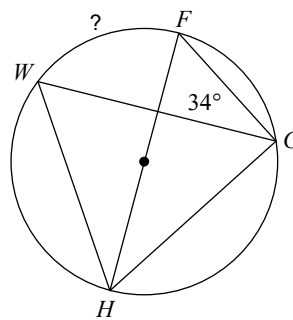

68°

265)

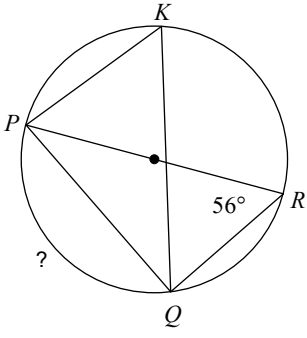

112°

266)

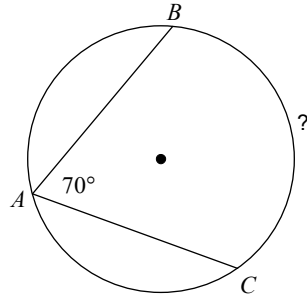

140°

267)

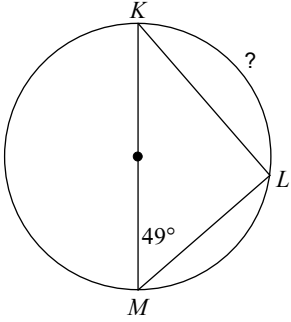

98°

268)

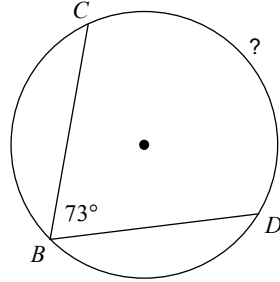

146°

269)

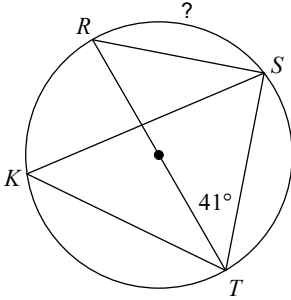

82°

270)

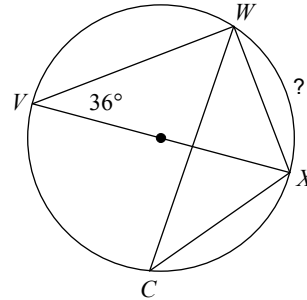

72°

271)

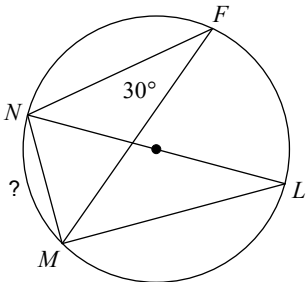

60°

272)

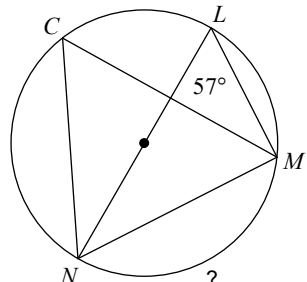

114°

273)

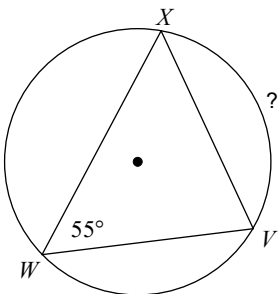

110°

274)

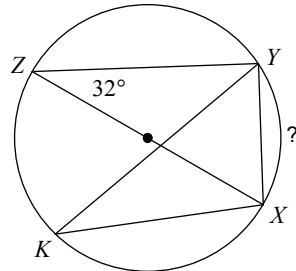

64°

275)

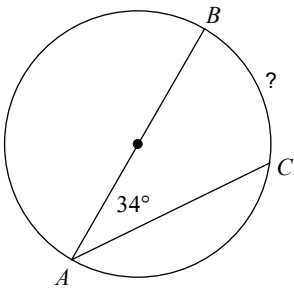

68°

276)

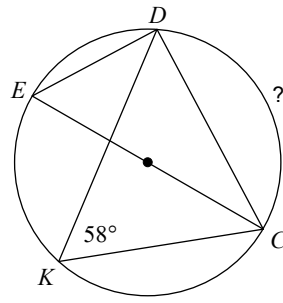

116°

277)

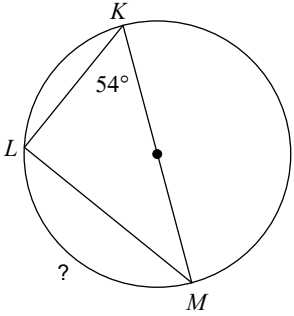

108°

278)

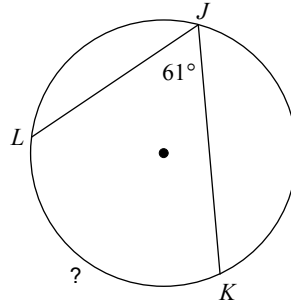

122°

279) Find $m\widehat{LMN}$

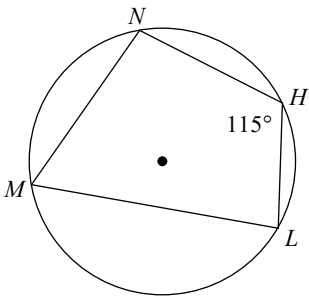

230°

280)

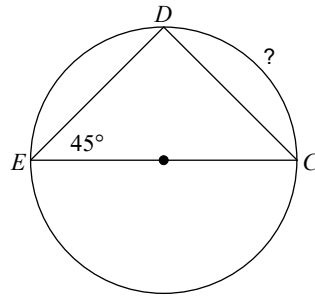

90°

281)

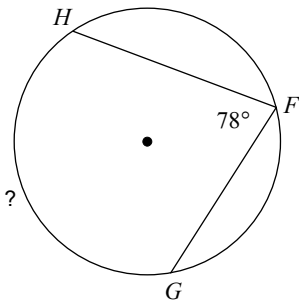

156°

282)

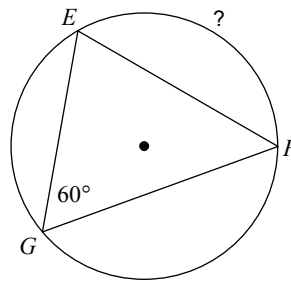

120°

283)

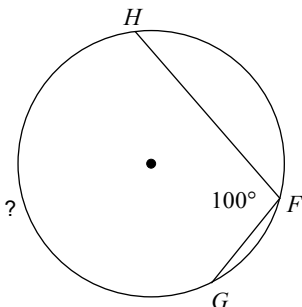

200°

284)

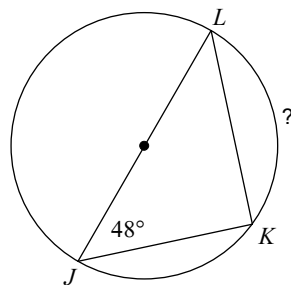

96°

285) Find $m\widehat{CE}$

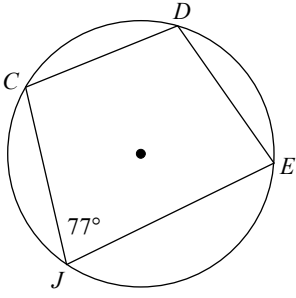

154°

286)

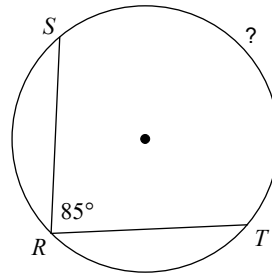

170°

287)

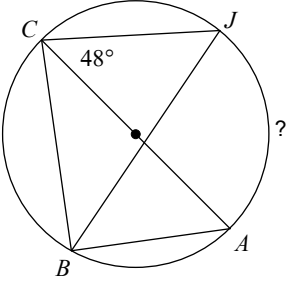

96°

288) Find $m\widehat{EG}$

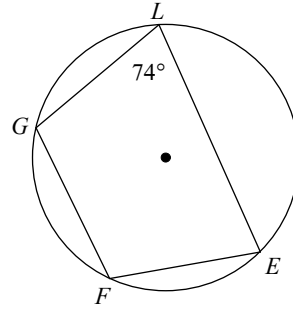

148°

289)

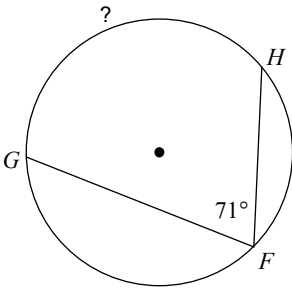

142°

290)

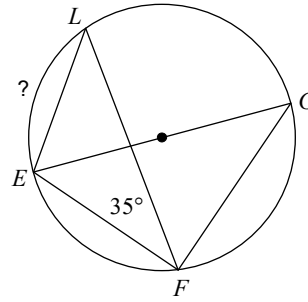

70°

291)

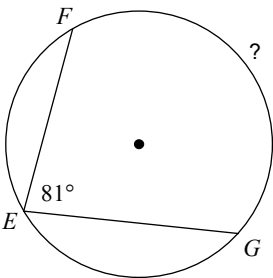

162°

292)

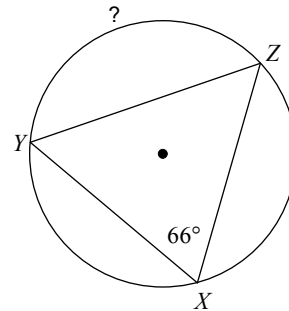

132°

293)

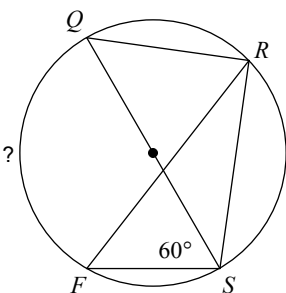

120°

294) Find $m\widehat{YXW}$

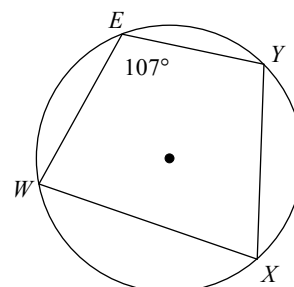

214°

295)

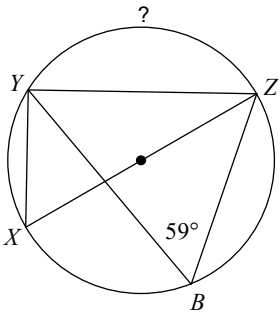

118°

296)

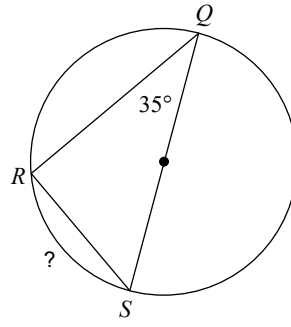

70°

297)

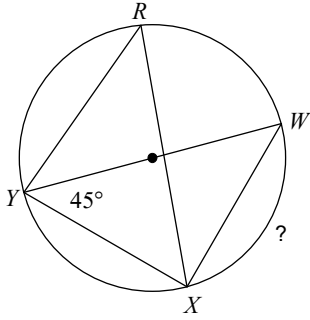

90°

298)

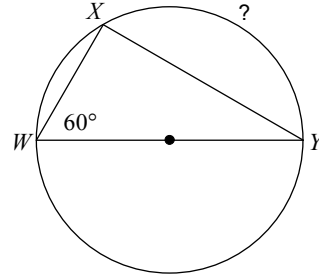

120°

299)

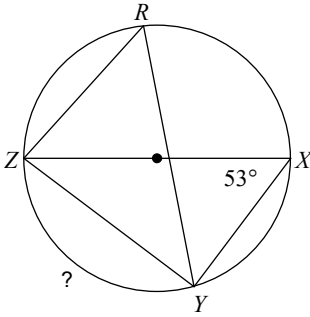

106°

300)

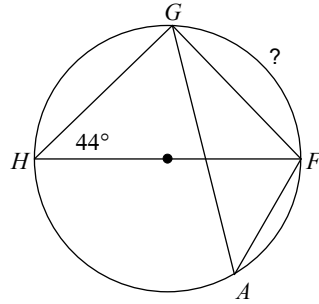

88°

301) Find $m\widehat{QS}$

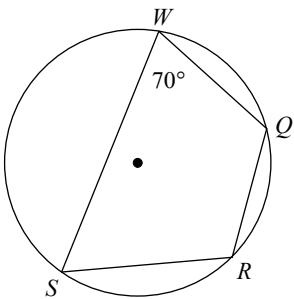

140°

302)

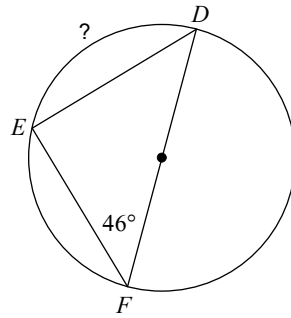

92°

303)

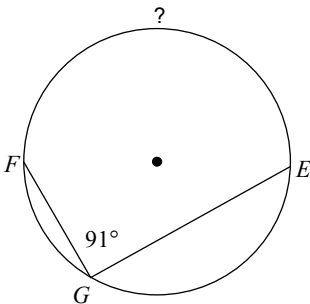

182°

304)

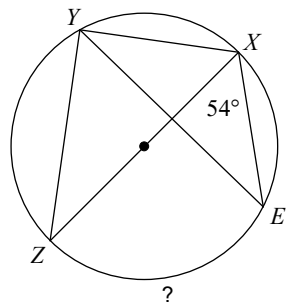

108°

305)

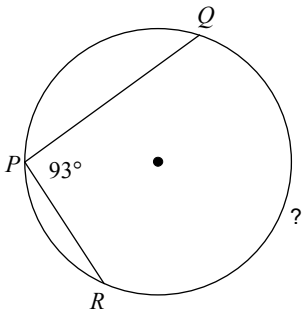

186°

306) Find $m\widehat{KLM}$

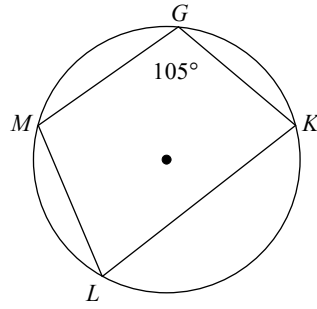

210°

307) Find $m\widehat{KLM}$

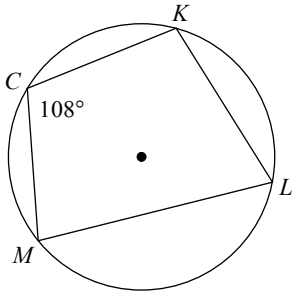

216°

308) Find $m\widehat{JKL}$

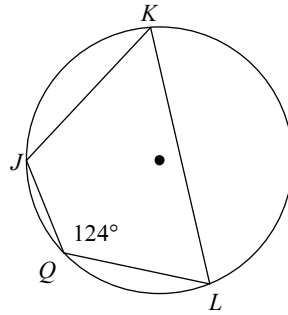

248°

309)

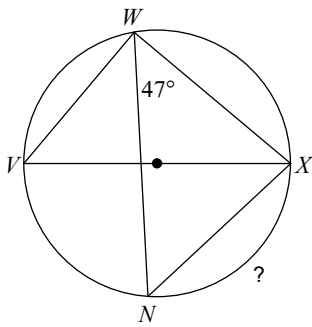

94°

310) Find $m\widehat{EDC}$

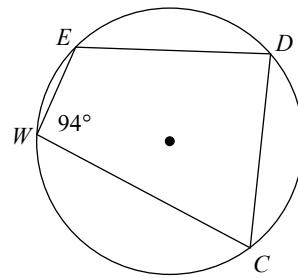

188°

311)

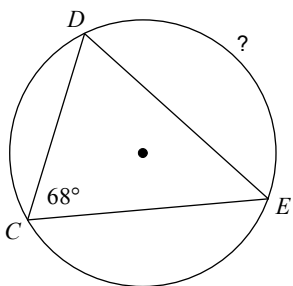

136°

312)

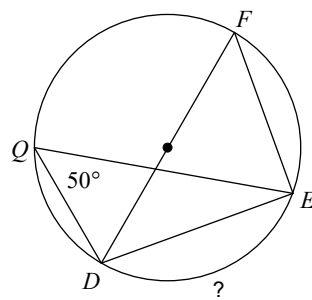

100°

313)

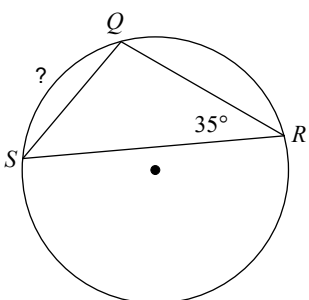

70°

314) Find $m\widehat{LN}$

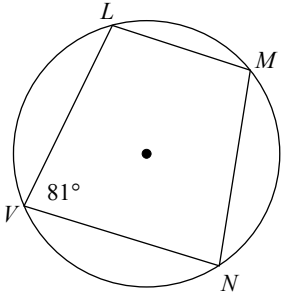

162°

315)

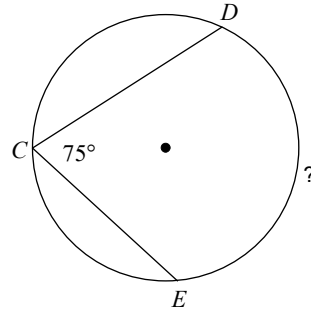

150°

316) Find $m\widehat{PQR}$

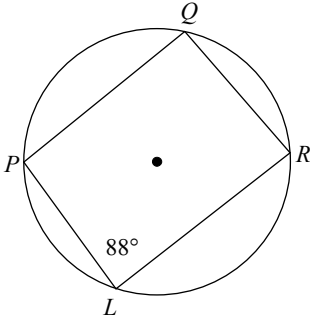

176°

317) Find $m\widehat{DEF}$

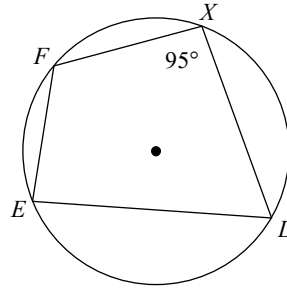

190°

318) Find $m\widehat{PQR}$

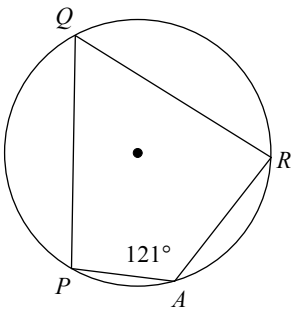

242°

319)

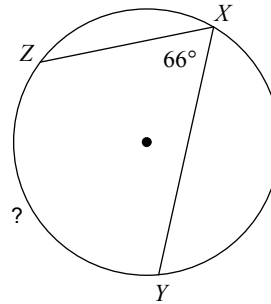

132°

320) Find $m\widehat{VWX}$

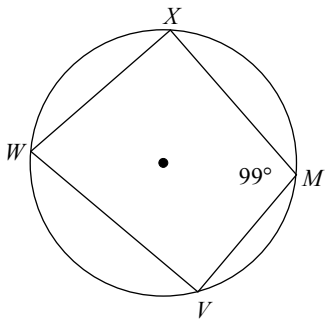

198°

321)

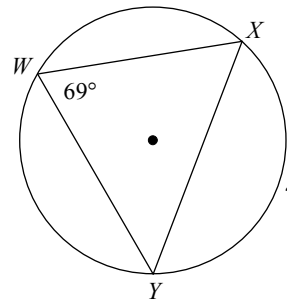

138°

322)

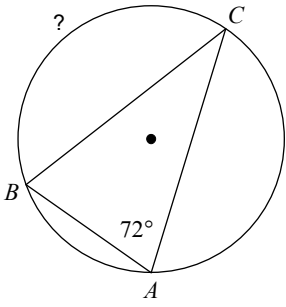

144°

323)

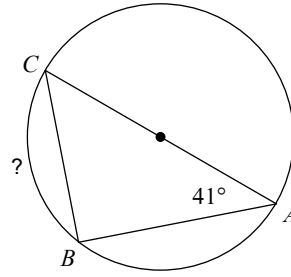

82°

324)

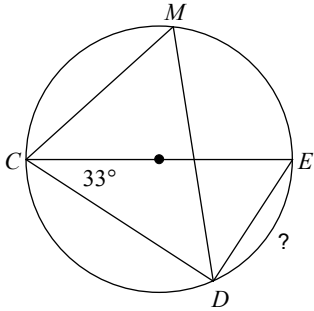

66°

325)

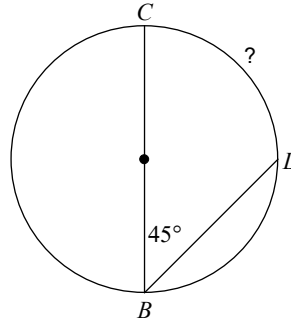

90°

326)

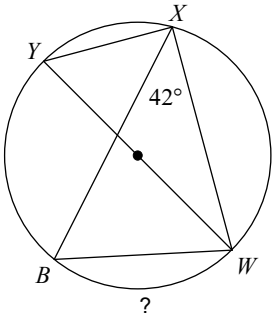

84°

327)

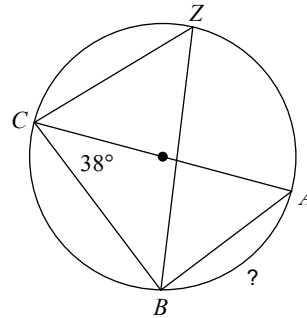

76°

328)

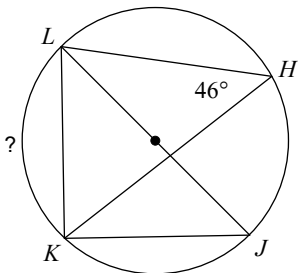

92°

329) Find $m\widehat{YXW}$

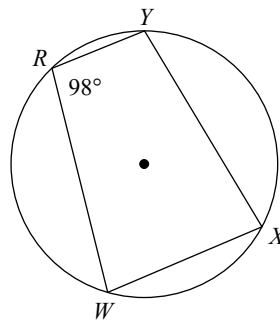

196°

330) Find $m\widehat{BCD}$

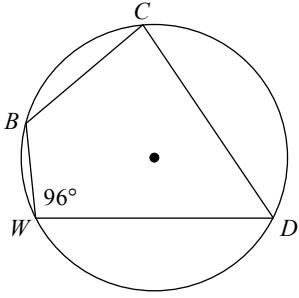

192°

331)

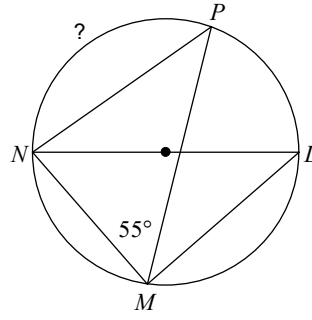

110°

332)

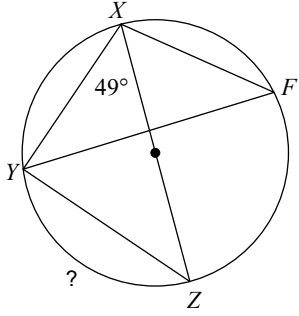

98°

333)

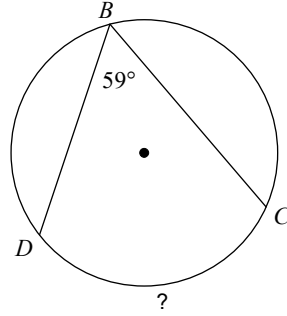

118°

334)

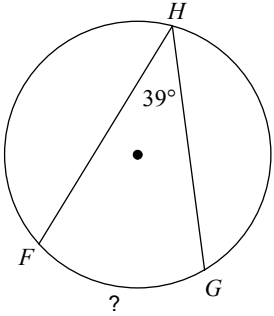

78°

335)

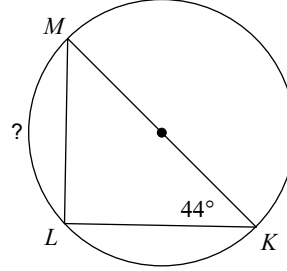

88°

336) Find $m\widehat{BD}$

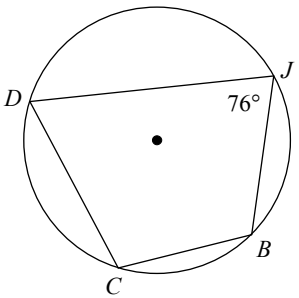

152°

337) Find $m\widehat{XWV}$

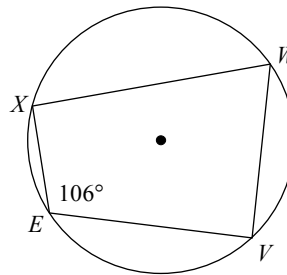

212°

338)

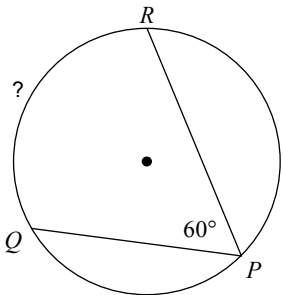

120°

339)

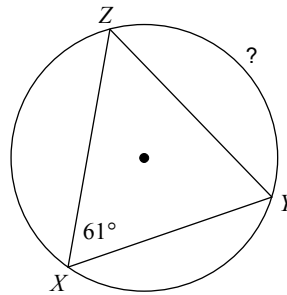

122°

340) Find $m\widehat{ABC}$

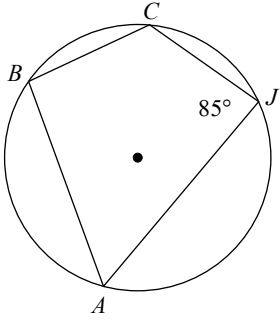

170°

341)

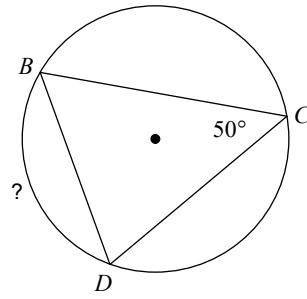

100°

342)

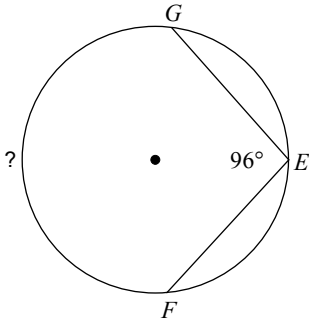

192°

343)

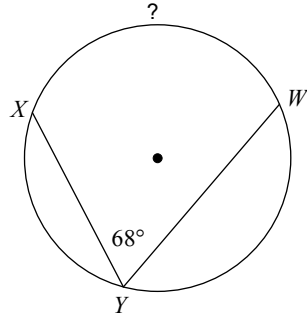

136°

344)

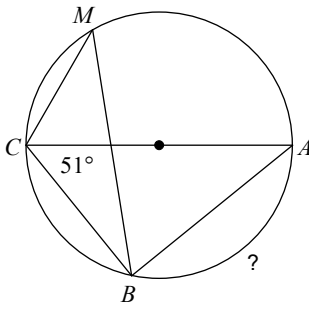

102°

345)

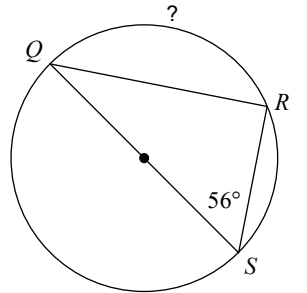

112°

346) Find $m\widehat{WXY}$

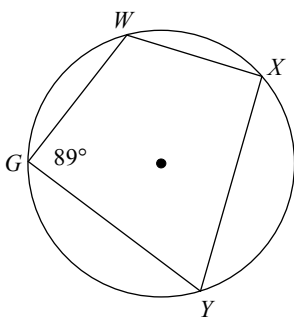

178°

347) Find $m\widehat{RT}$

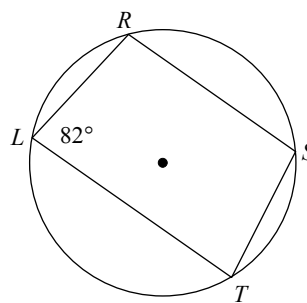

164°

348)

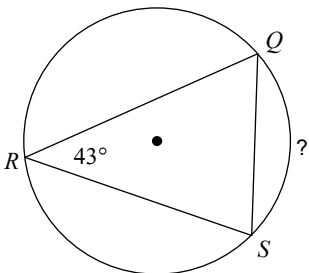

86°

349)

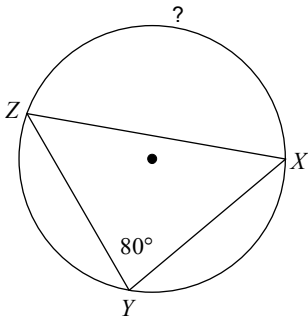

160°

350)

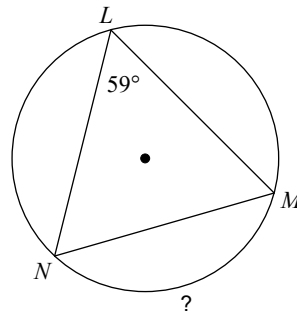

118°

351)

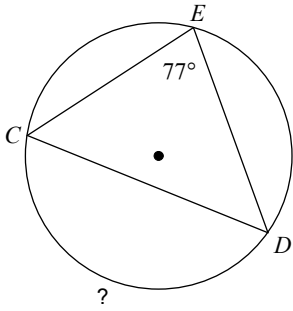

154°

352)

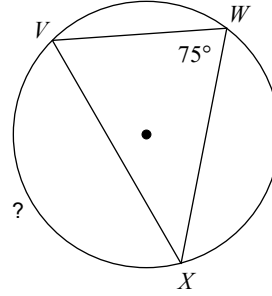

150°

353)

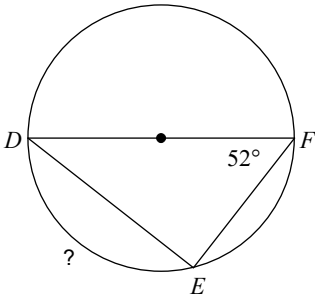

104°

354)

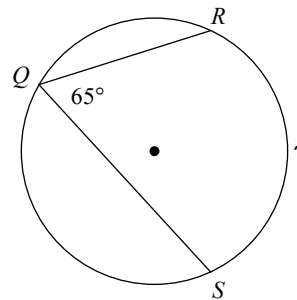

130°

355)

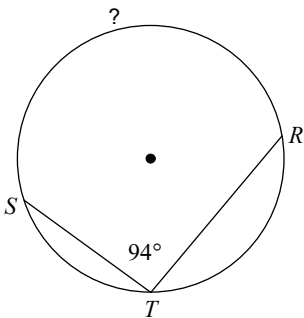

188°

356) Find $m\widehat{KM}$

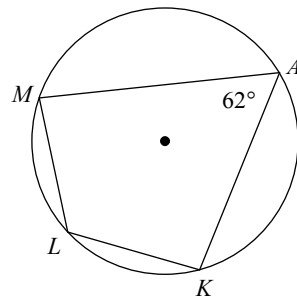

124°

357)

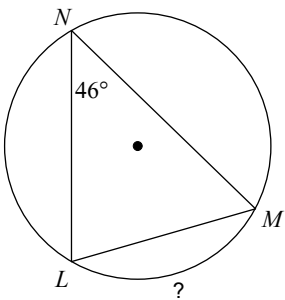

92°

358) Find $m\widehat{SRQ}$

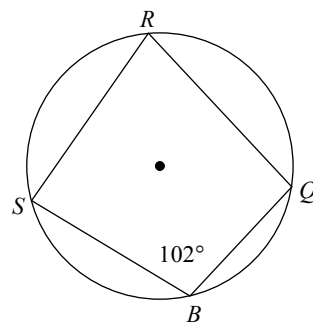

204°

359)

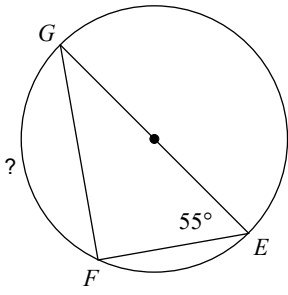

110°

360)

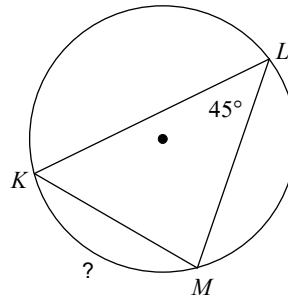

90°

361)

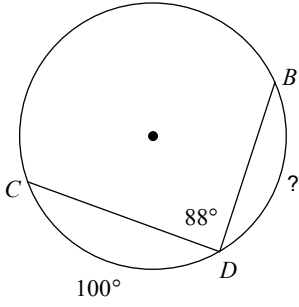

84°

362)

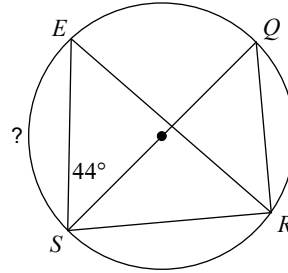

92°

363)

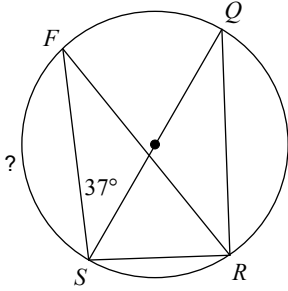

106°

364)

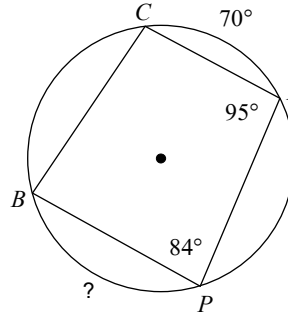

92°

365)

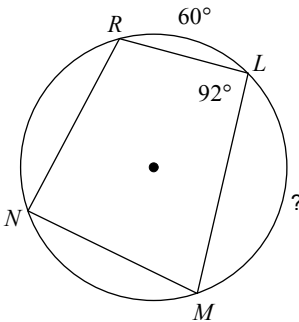

116°

366)

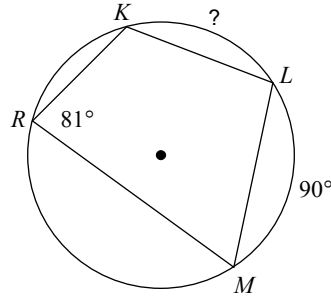

72°

367)

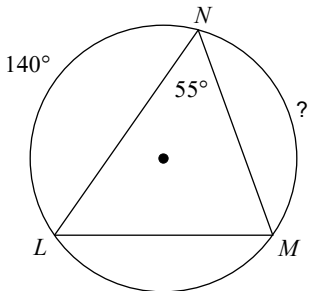

110°

368)

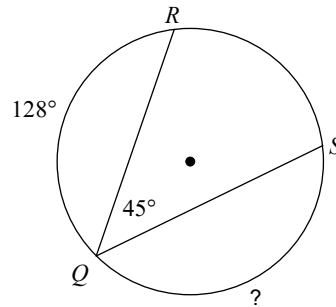

142°

369)

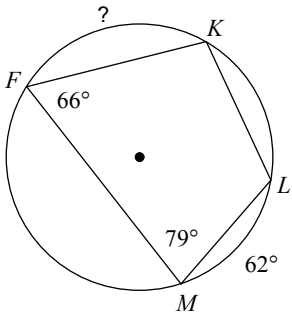

88°

370)

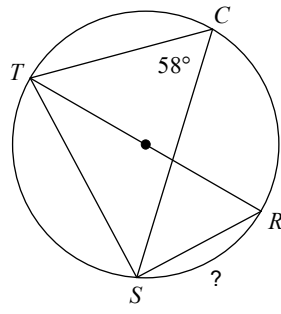

64°

371)

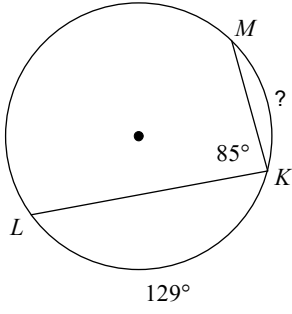

61°

372)

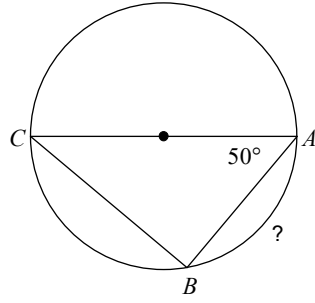

80°

373)

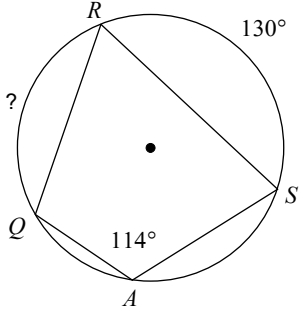

98°

374)

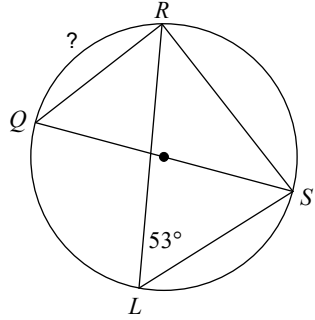

74°

375)

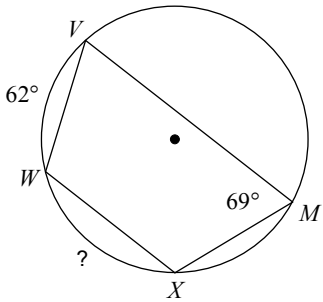

76°

376)

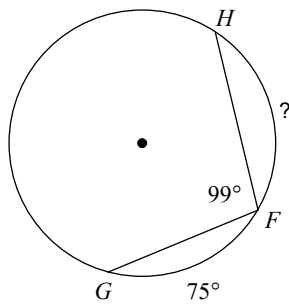

87°

377)

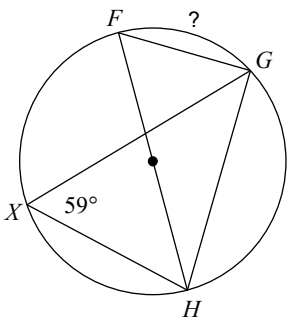

62°

378)

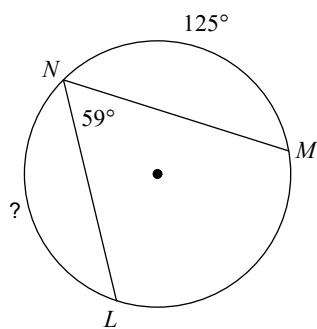

117°

379)

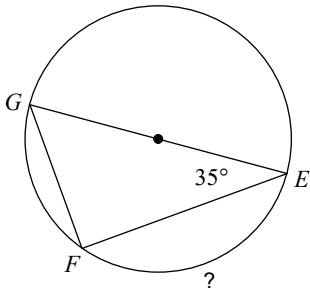

110°

380)

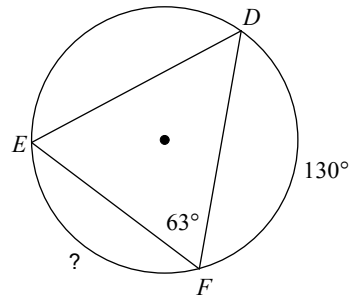

104°

381)

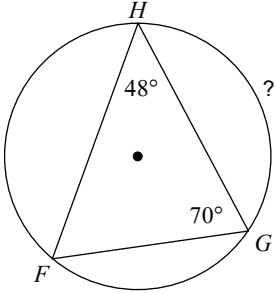

124°

382)

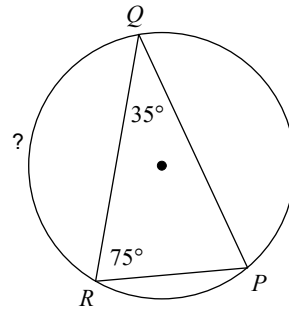

140°

383)

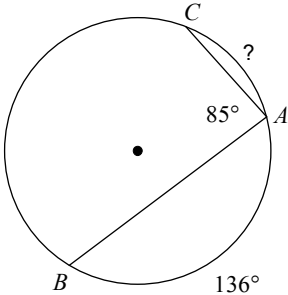

54°

384)

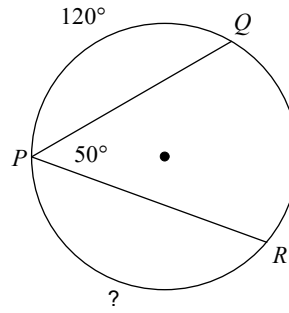

140°

385)

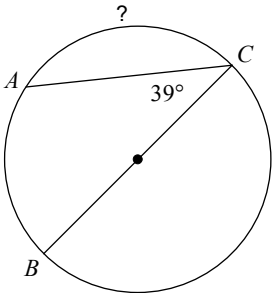

102°

386)

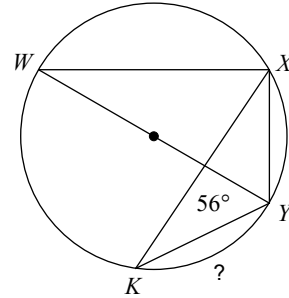

68°

387)

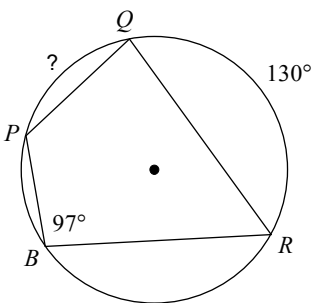

64°

388)

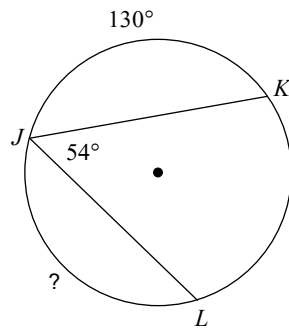

122°

389)

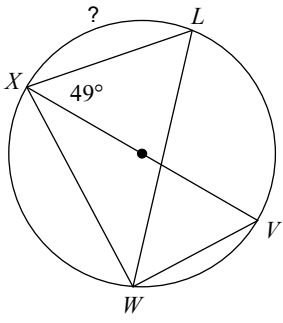

82°

390)

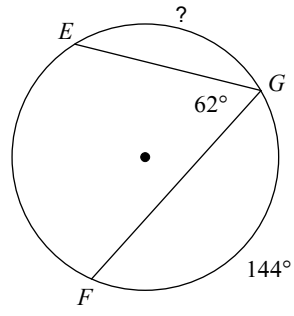

92°

391)

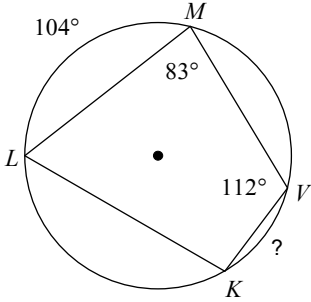

46°

392)

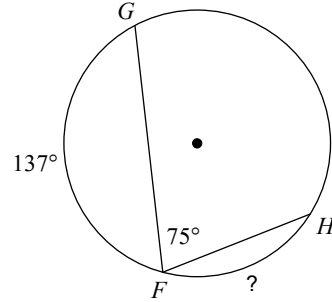

73°

393)

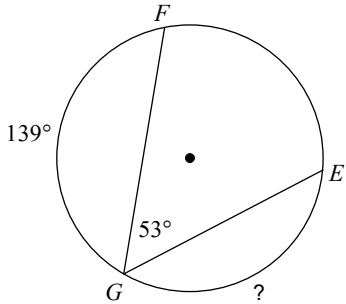

115°

394)

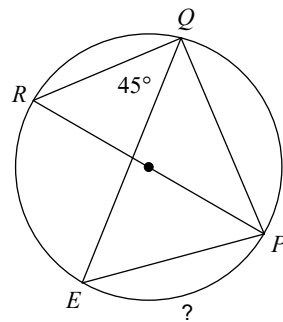

90°

395)

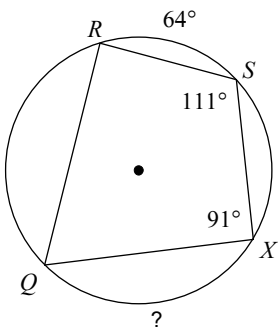

104°

396)

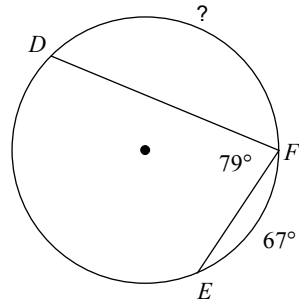

135°

397)

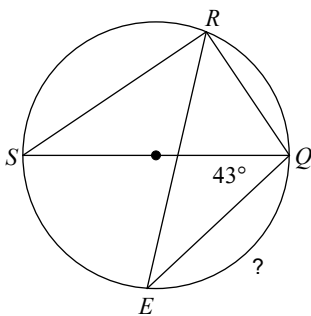

94°

398)

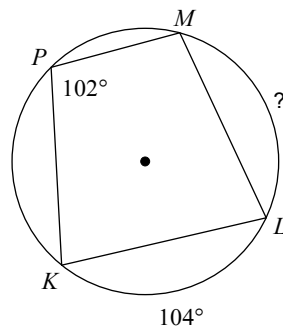

100°

399)

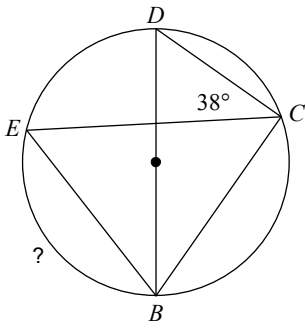

104°

400)

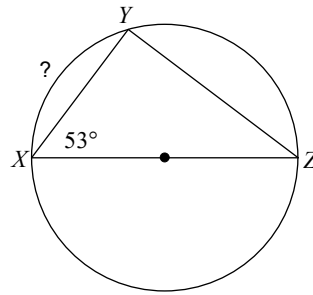

74°

401)

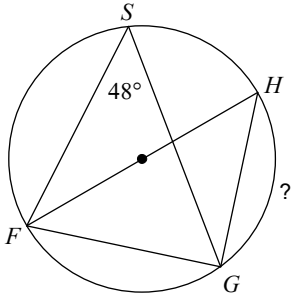

84°

402)

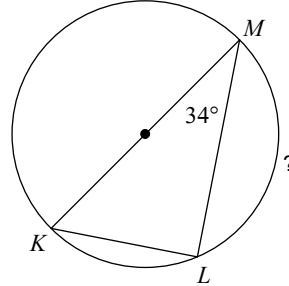

112°

403)

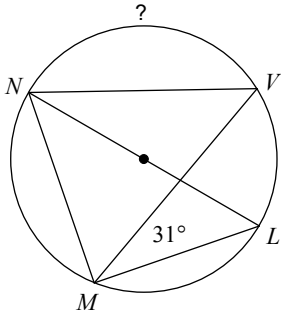

118°

404)

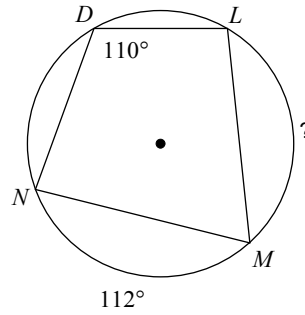

108°

405)

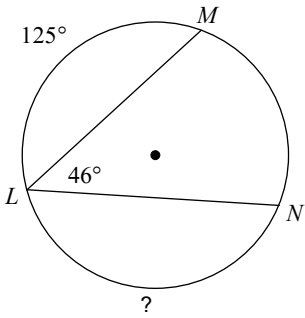

143°

406)

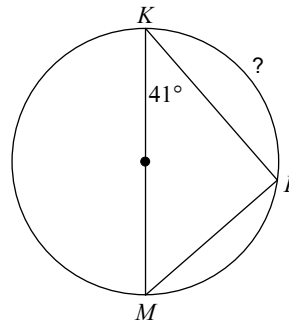

98°

407)

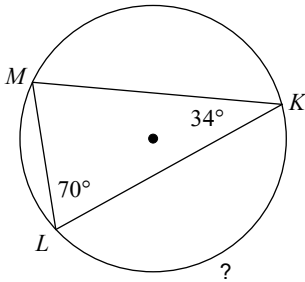

152°

408)

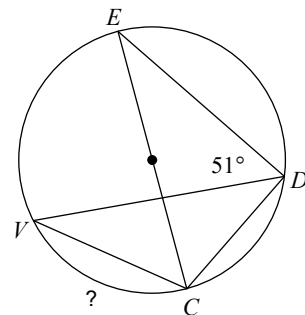

78°

409)

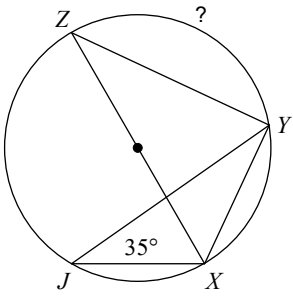

110°

410)

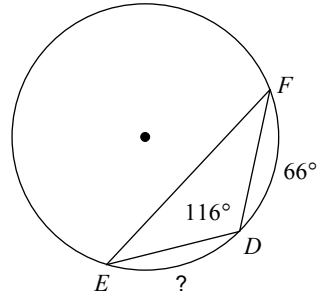

62°

411)

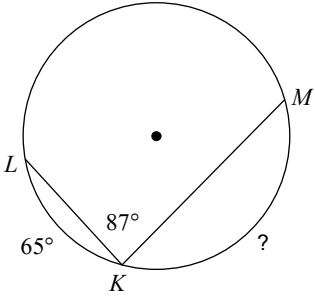

121°

412)

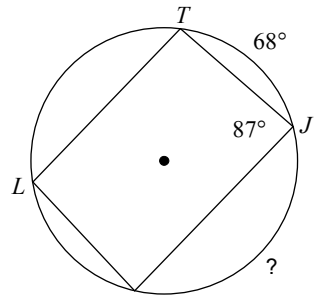

118°

413)

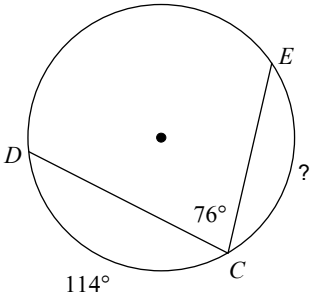

94°

414)

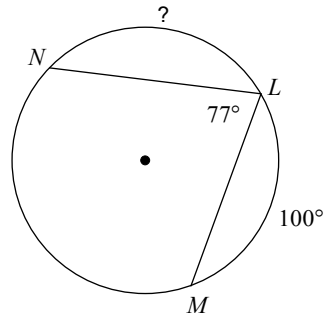

106°

415)

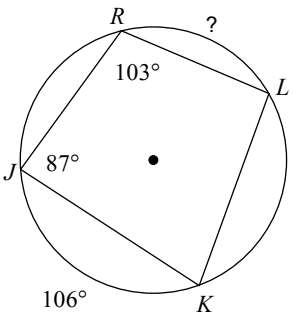

74°

416)

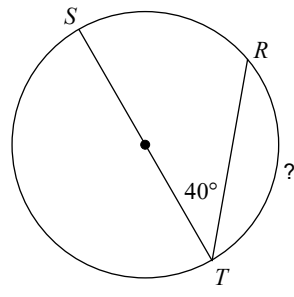

100°

417)

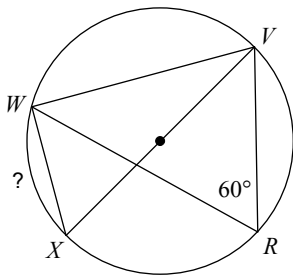

60°

418)

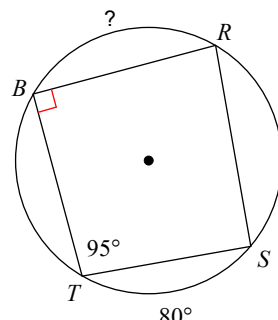

90°

419)

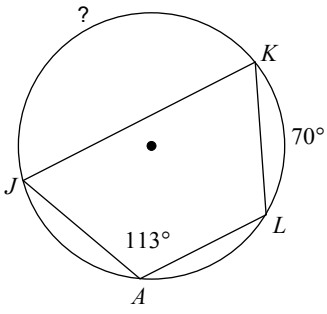

156°

420)

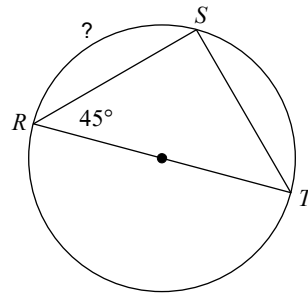

90°

421)

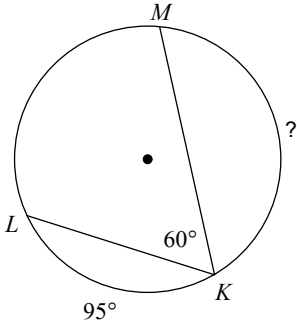

145°

422)

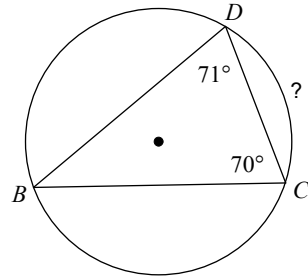

78°

423)

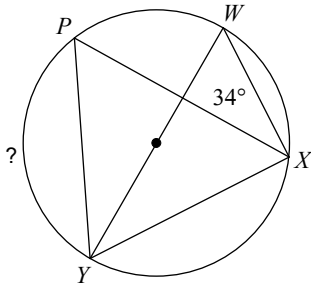

112°

424)

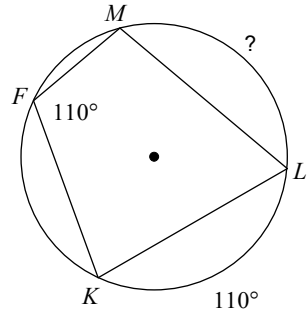

110°

425)

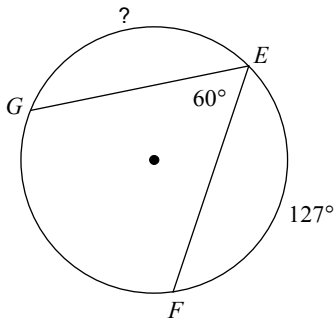

113°

426)

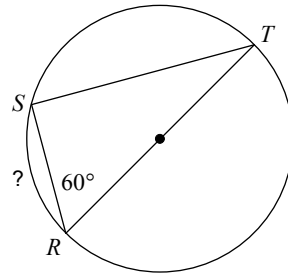

60°

427)

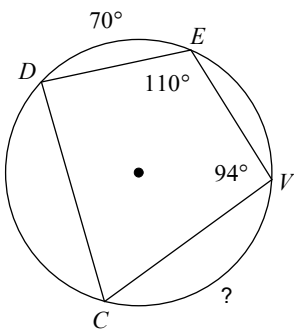

102°

428)

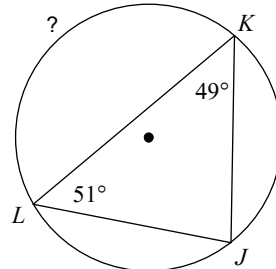

160°

429)

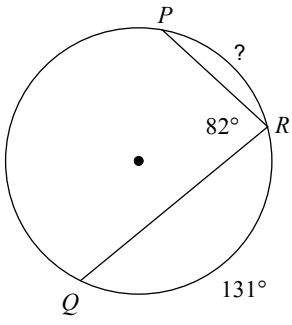

65°

430)

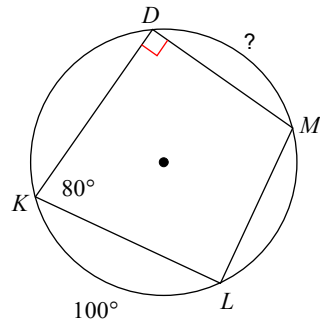

80°

431)

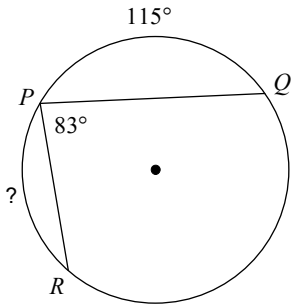

79°

432)

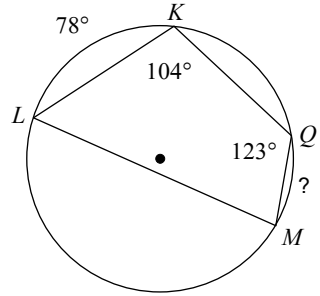

40°

433)

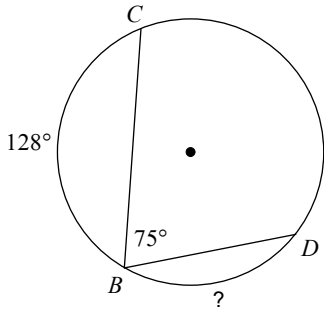

82°

434)

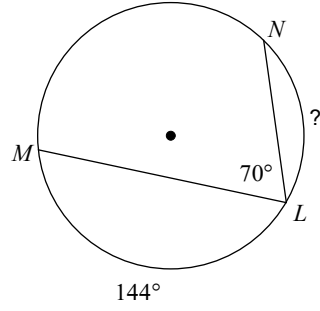

76°

435)

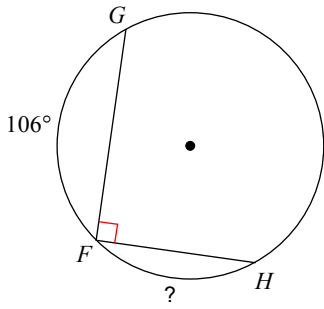

74°

436)

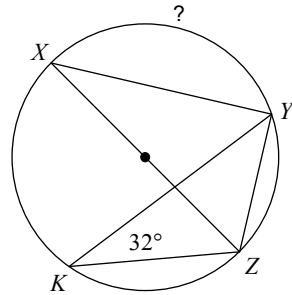

116°

437)

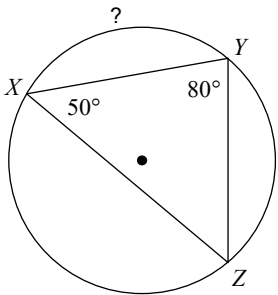

100°

438)

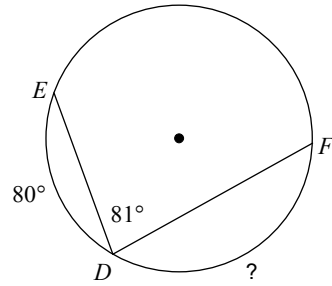

118°

439)

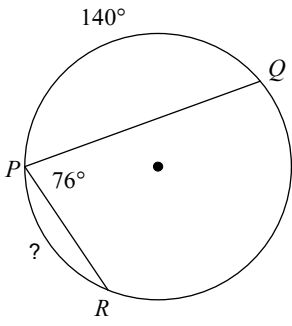

68°

440)

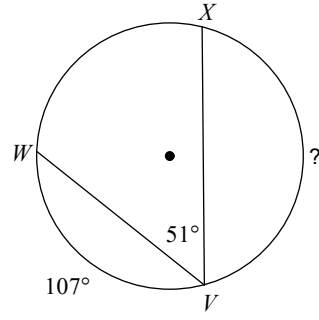

151°

441)

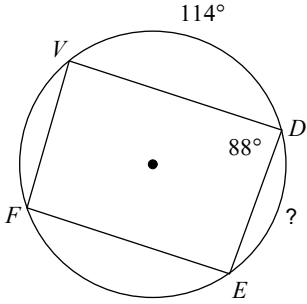

70°

442)

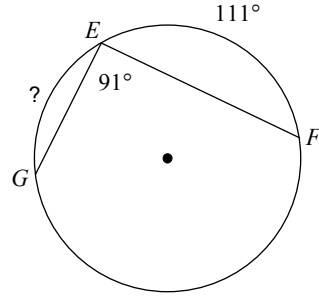

67°

443)

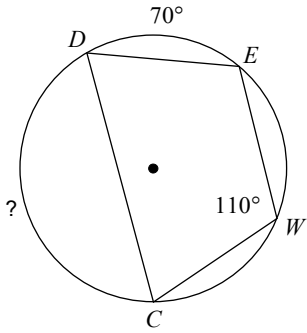

150°

444)

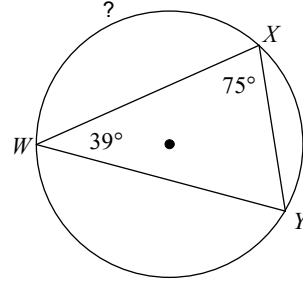

132°

445)

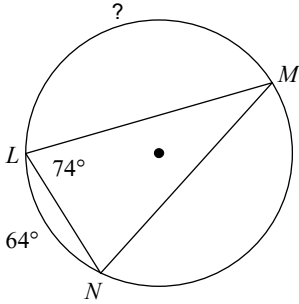

148°

446)

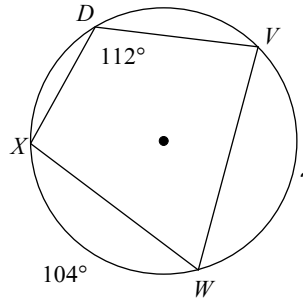

120°

447)

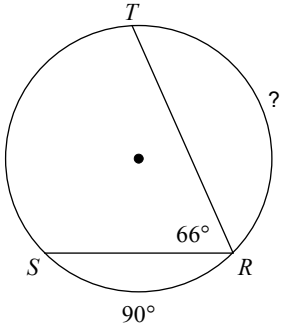

138°

448)

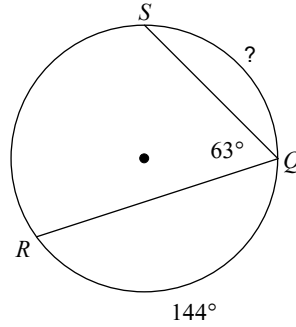

90°

449)

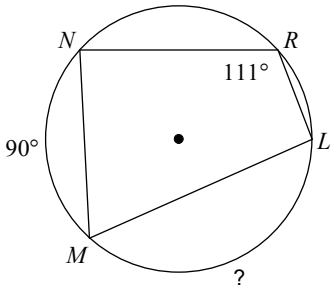

132°

450)

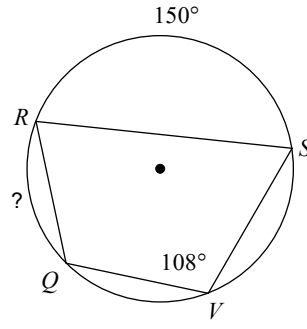

66°

451)

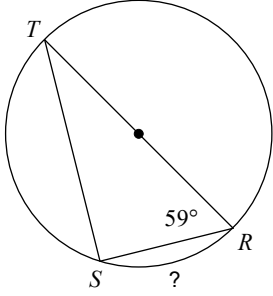

62°

452)

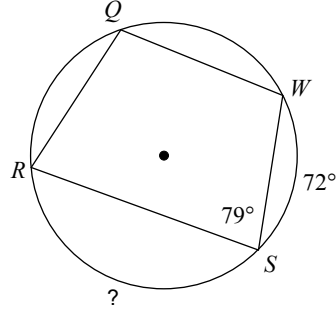

130°

453)

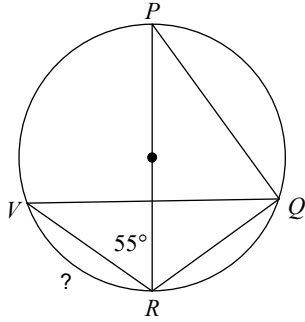

70°

454)

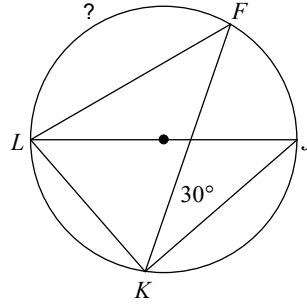

120°

455)

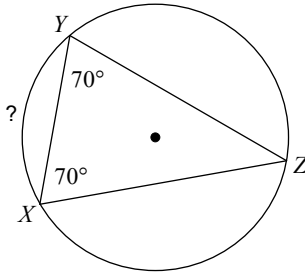

80°

456)

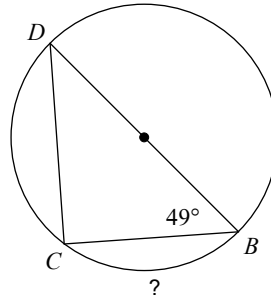

82°

457)

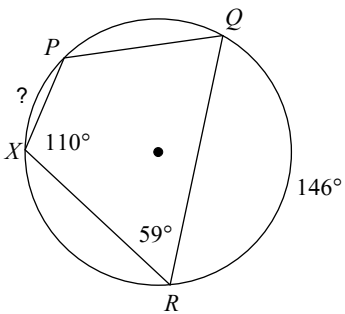

44°

458)

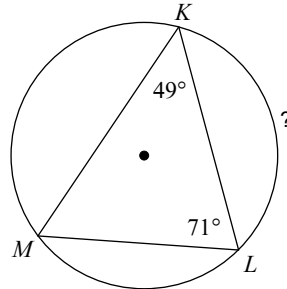

120°

459)

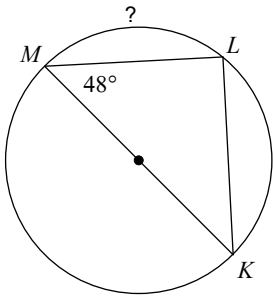

84°

460)

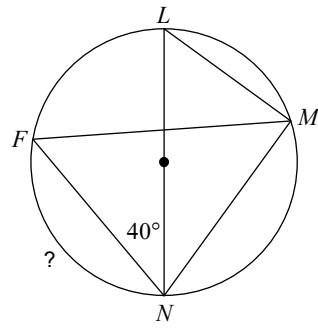

100°

Find the angle measure by solving the unknown

461)

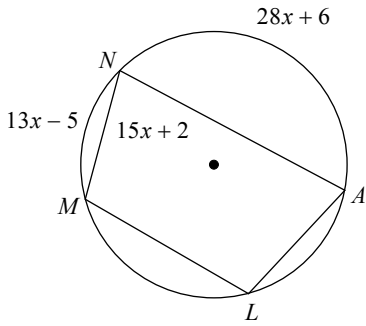

5

462)

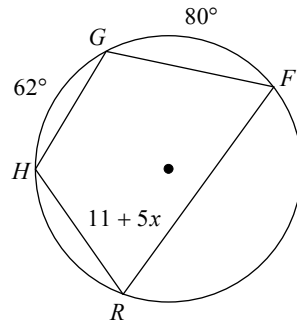

12

463)

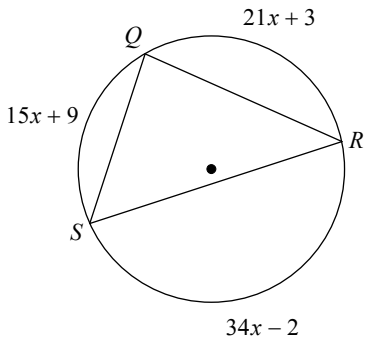

5

464)

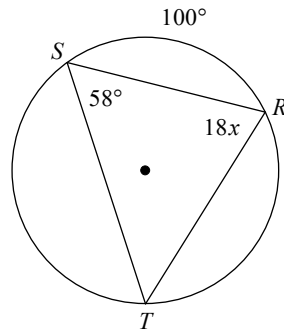

4

465)

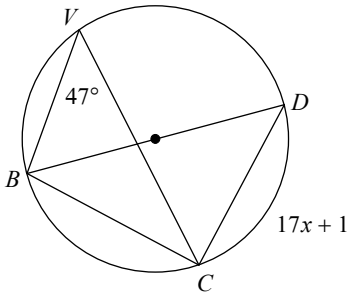

5

466)

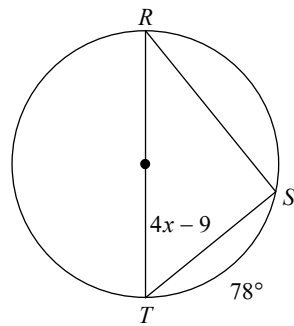

15

467)

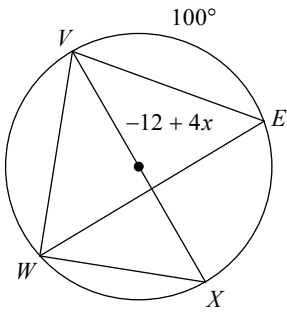

13

468)

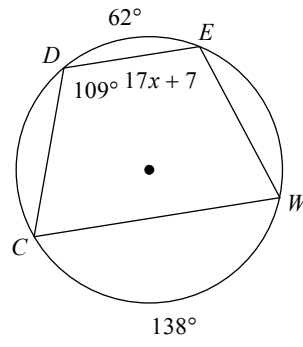

6

469)

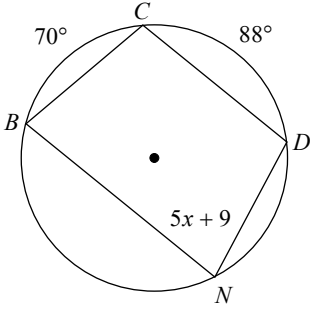

14

470)

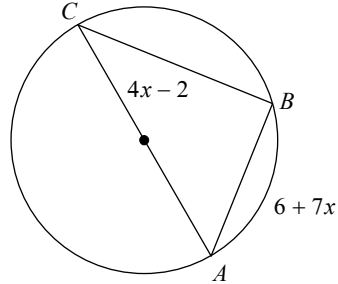

10

471)

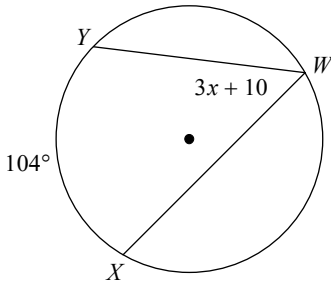

14

472)

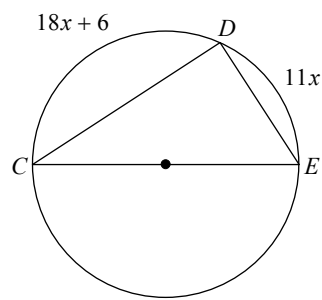

6

473)

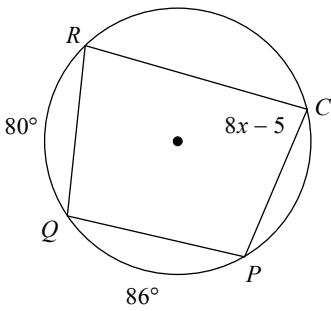

11

474)

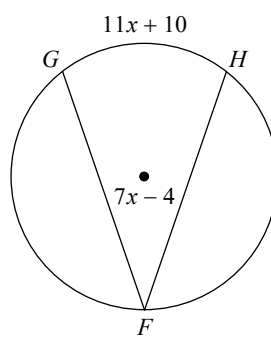

6

475)

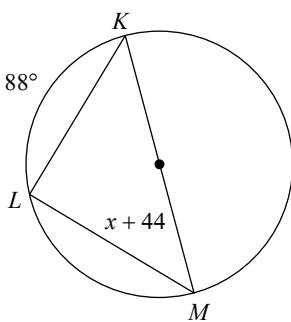

0

476)

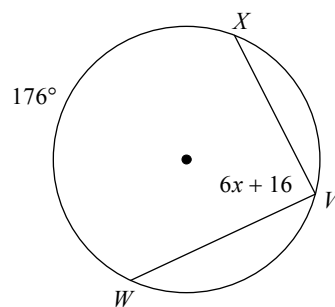

12

477)

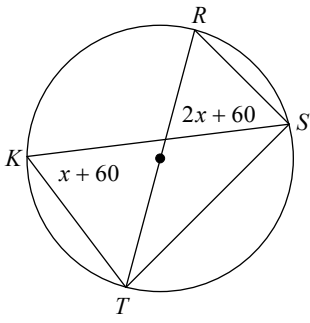

0

478)

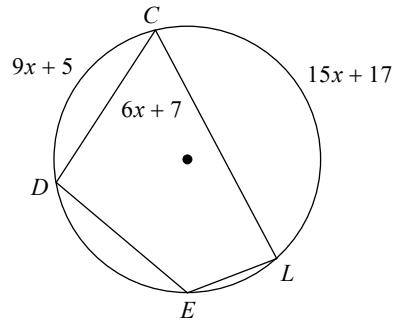

9

479)

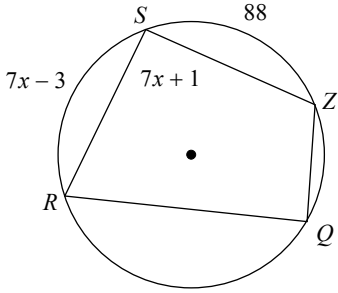

13

480)

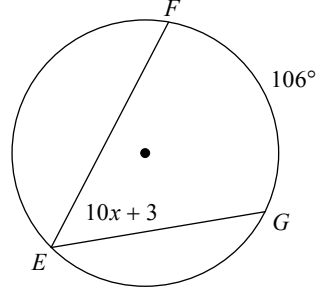

5

481)

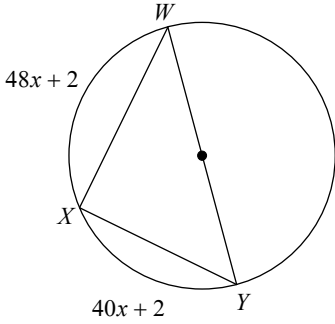

2

482)

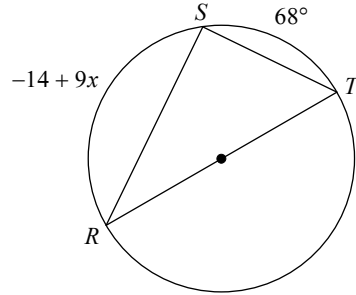

14

483)

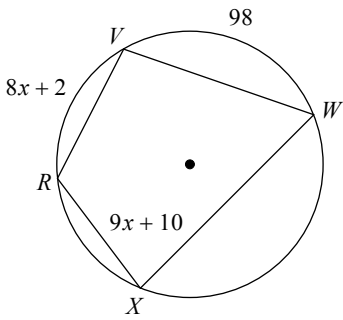

8

484)

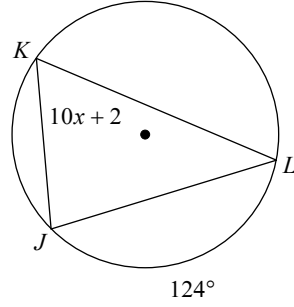

6

485)

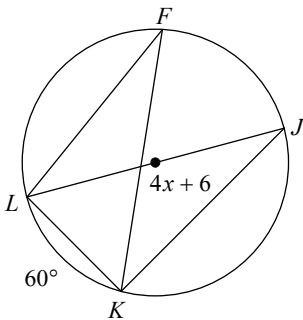

6

486)

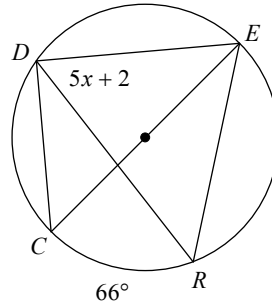

11

487)

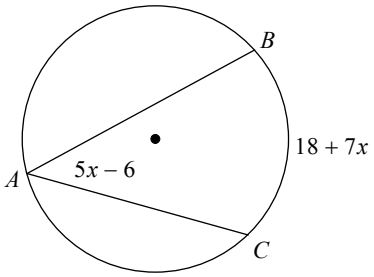

10

488)

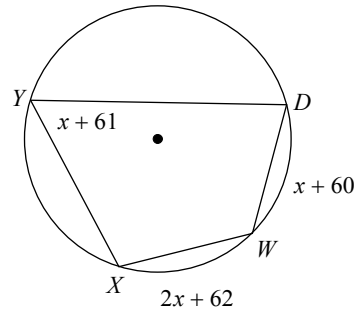

0

489)

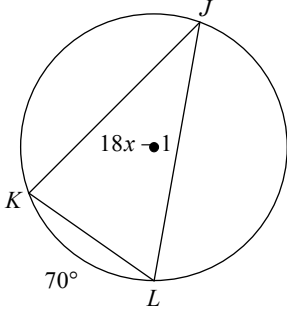

2

490)

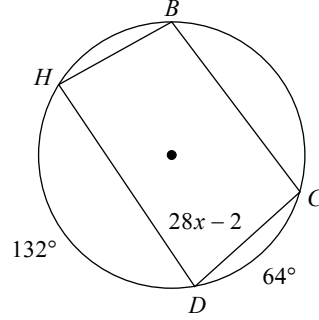

3

491)

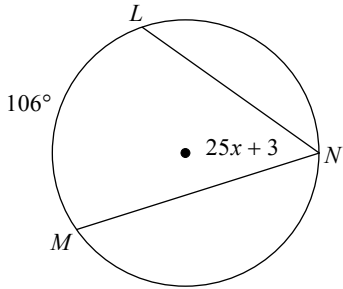

2

492)

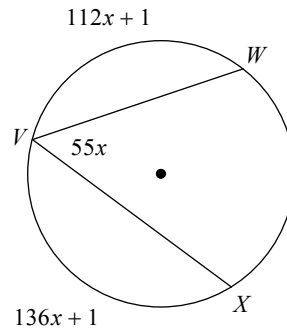

1

493)

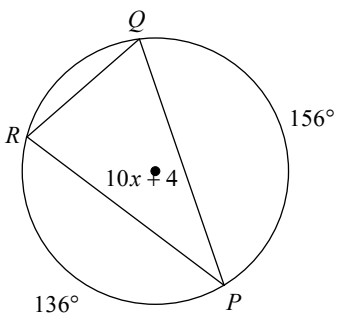

3

494)

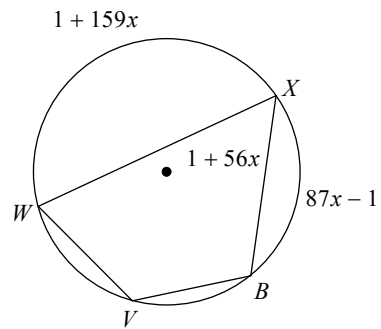

1

495)

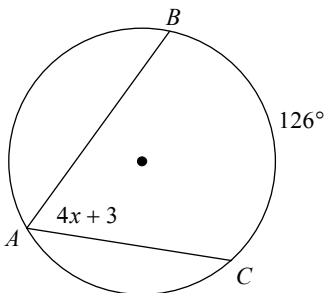

15

496)

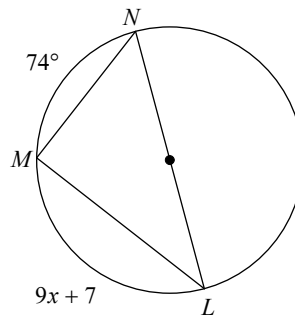

11

497)

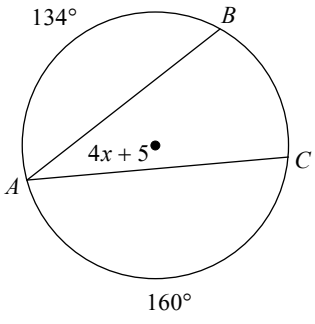

7

498)

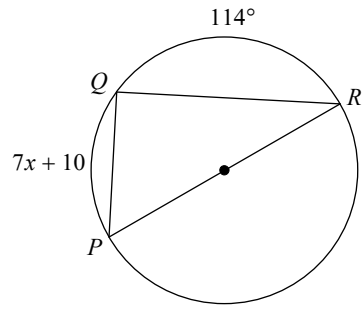

8

499)

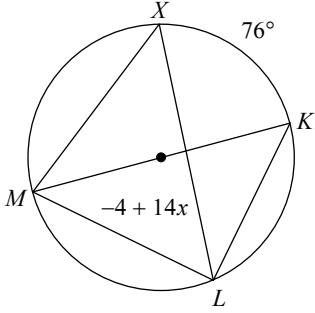

4

500)

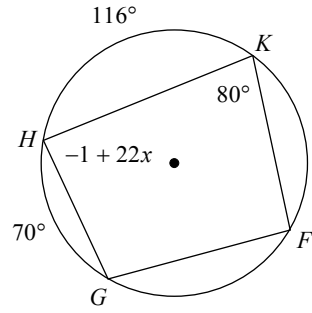

4

501)

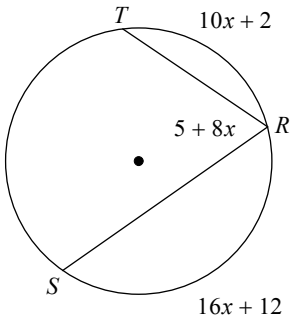

8

502)

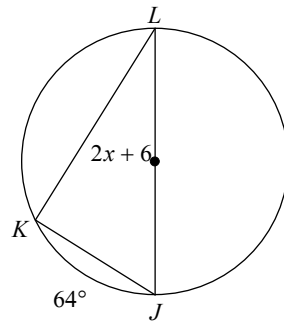

13

503)

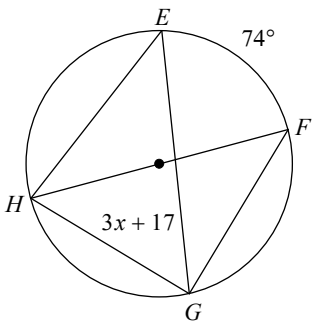

12

504)

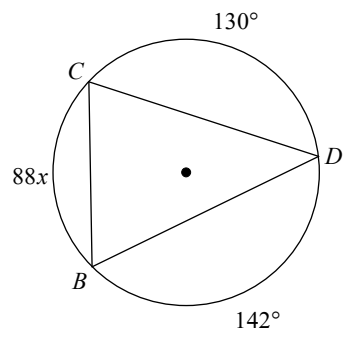

1

505)

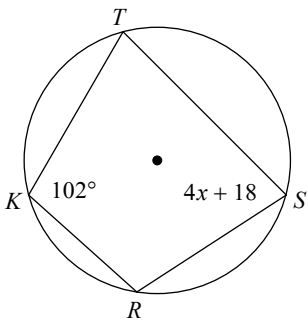

15

506)

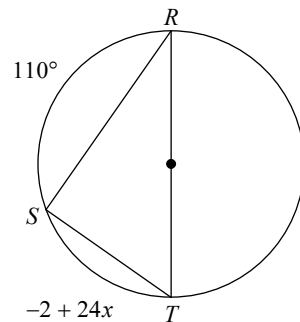

3

507)

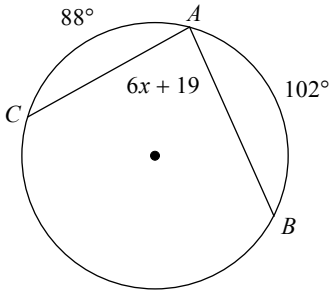

11

508)

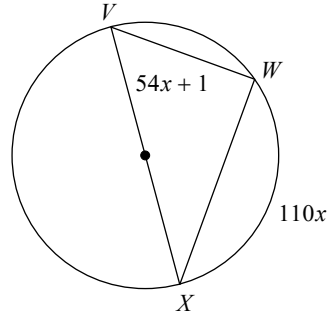

1

509)

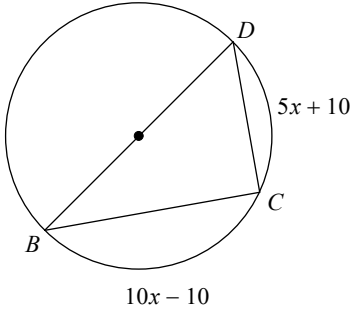

12

510)

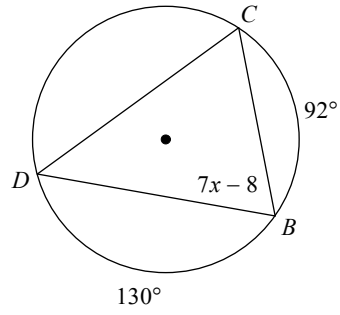

11

511)

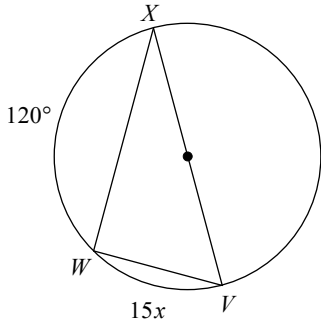

4

512)

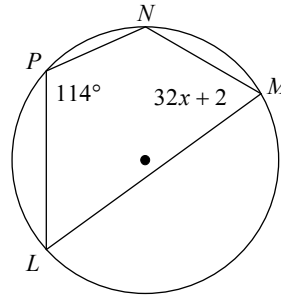

2

513)

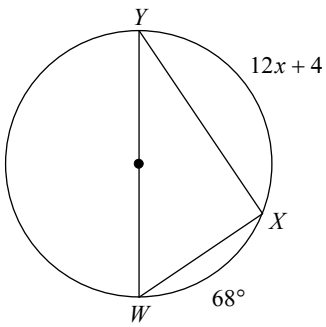

9

514)

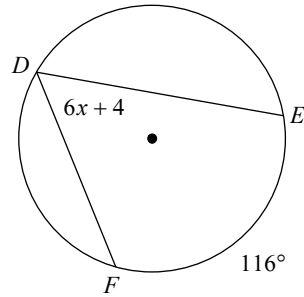

9

515)

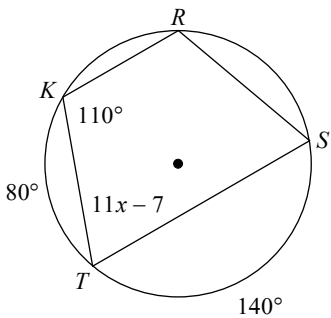

7

516)

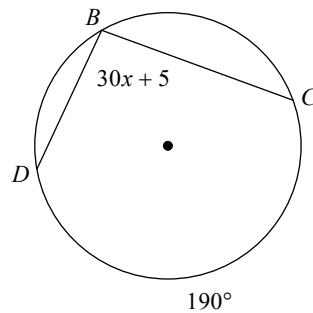

3

517)

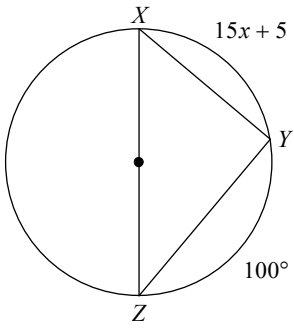

5

518)

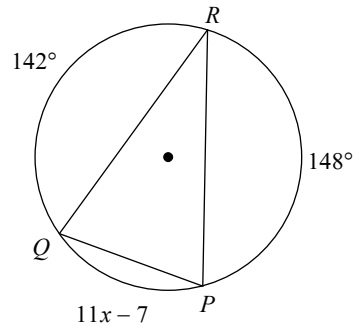

7

519)

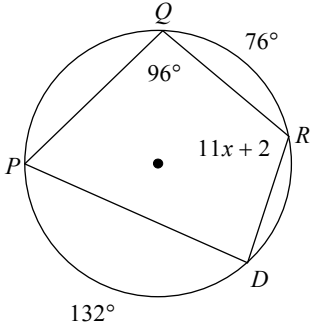

10

520)

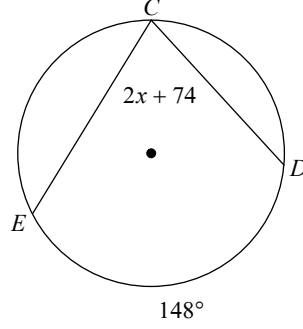

0

521)

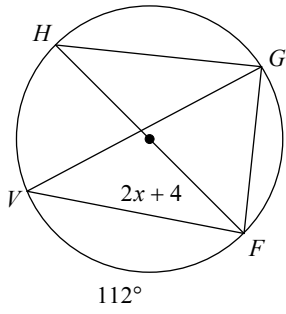

15

522)

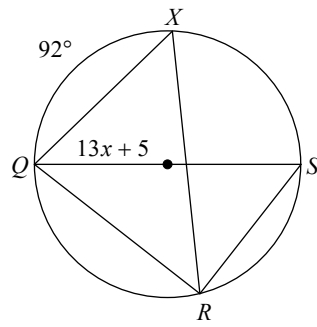

3

523)

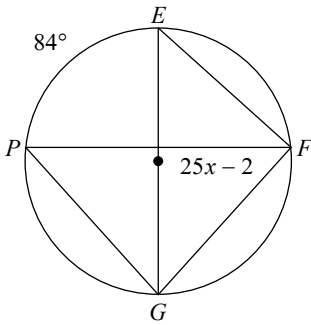

2

524)

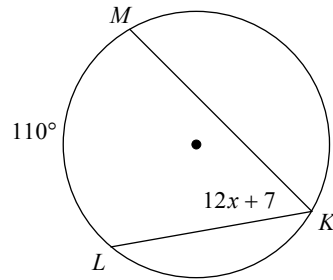

4

525)

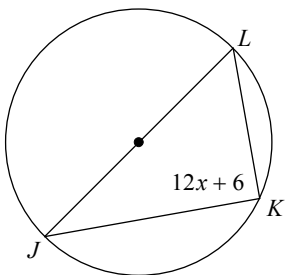

7

526)

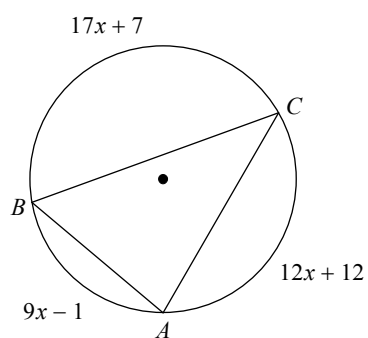

9

527)

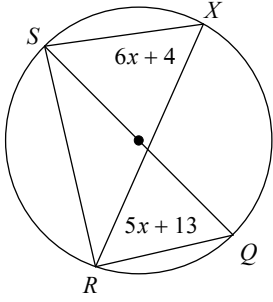

9

528)

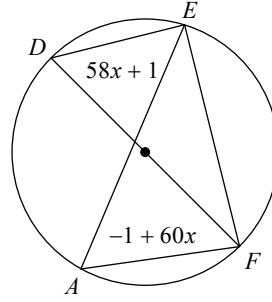

1

529)

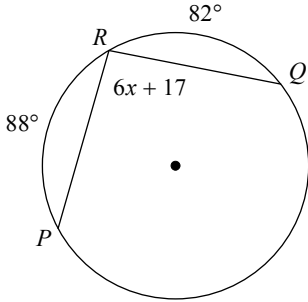

13

530)

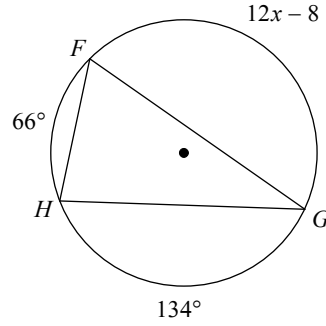

14

531)

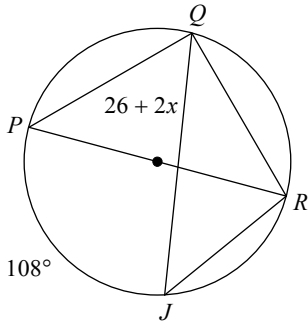

14

532)

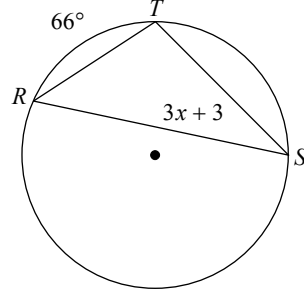

10

533)

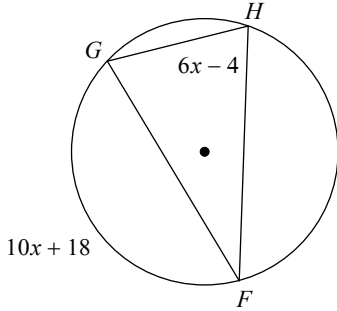

13

534)

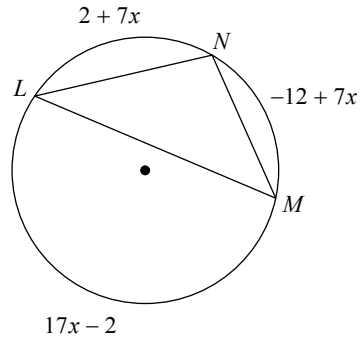

12

535)

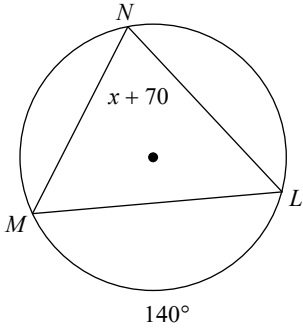

0

536)

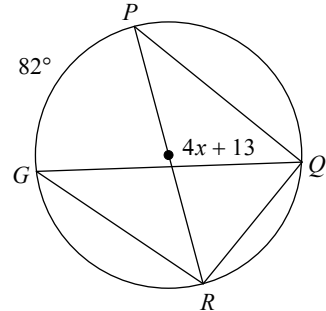

7

537)

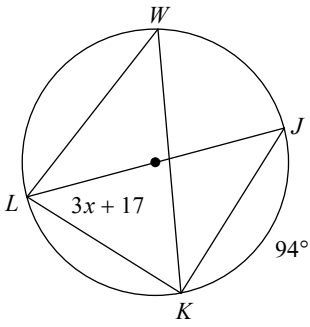

10

538)

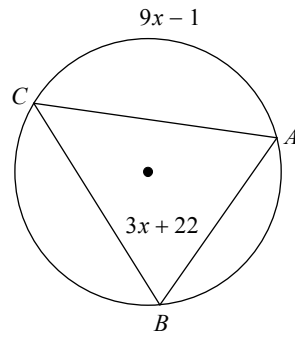

15

539)

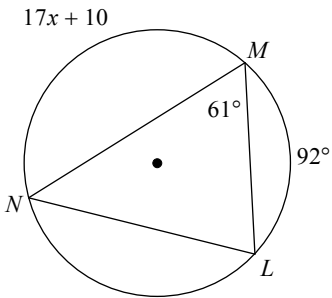

8

540)

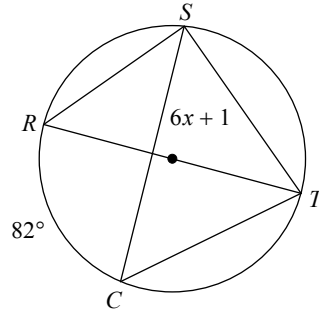

8

541) Find $m\angle RLK$

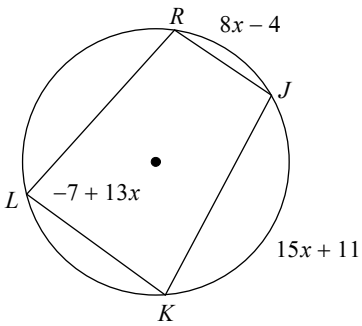

84°

542) Find $m\angle PRQ$

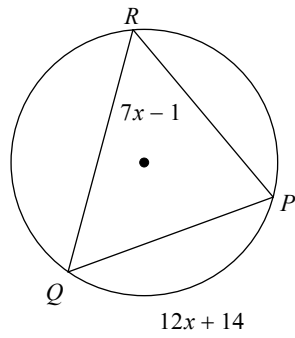

55°

543) Find $m\angle YDW$

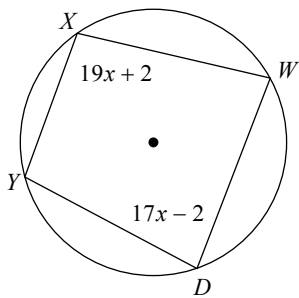

83°

544) Find $m\angle CEA$

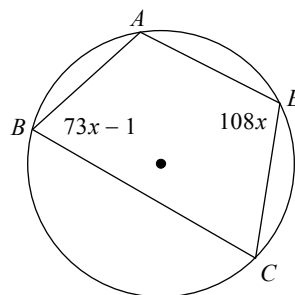

108°

545) Find $m\angle FSG$

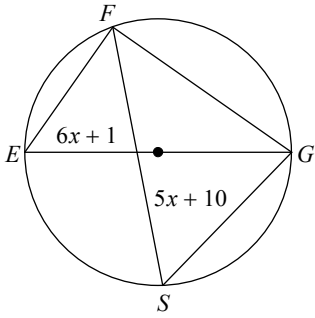

55°

546) Find $m\angle DBC$

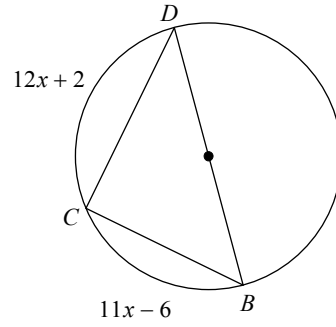

49°

547) Find $m\angle BLM$

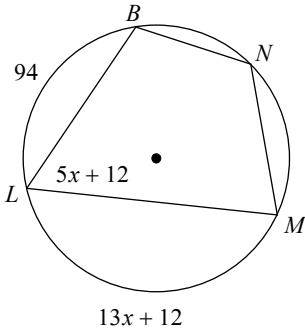

62°

548) Find $m\angle MCN$

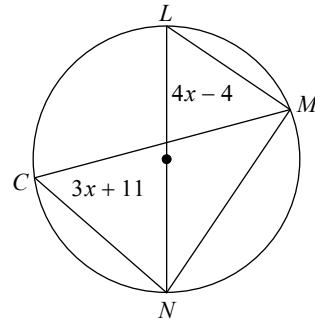

56°

549) Find $m\angle CBD$

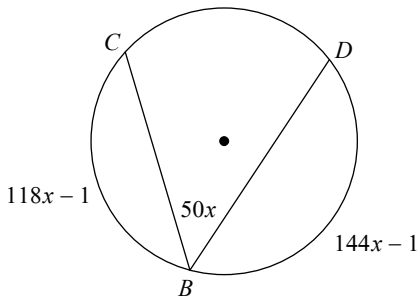

50°

550) Find $m\angle EFD$

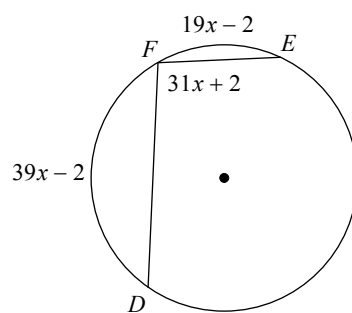

95°

551) Find $m\angle VXW$

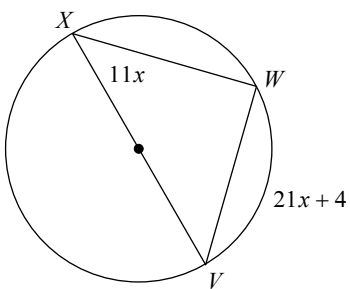

44°

552) Find $m\angle CAB$

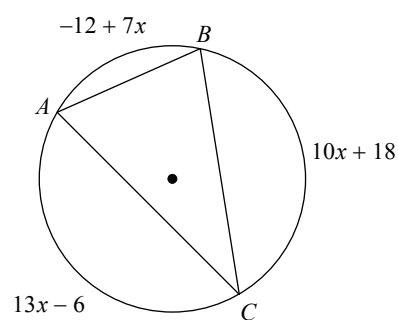

69°

553) Find $m\angle RYQ$

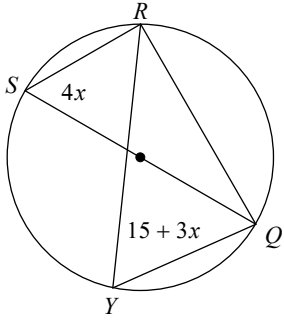

60°

554) Find $m\angle KBM$

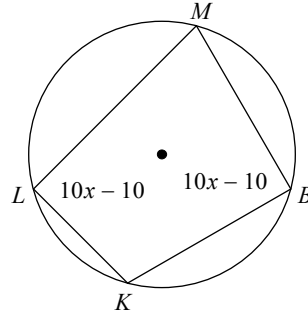

90°

555) Find $m\angle DEC$

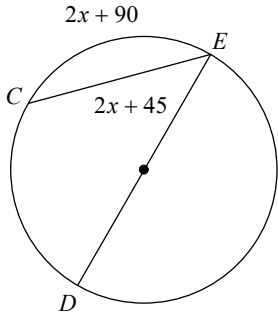

45°

556) Find $m\angle CAB$

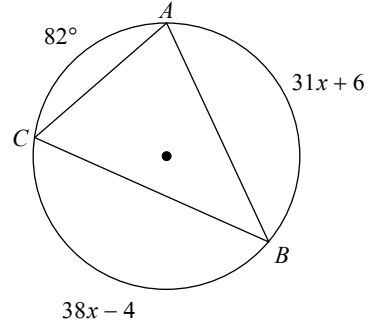

74°

557) Find $m\angle KML$

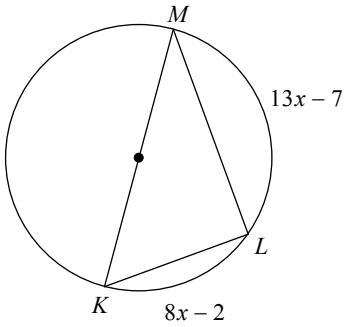

35°

558) Find $m\angle PNM$

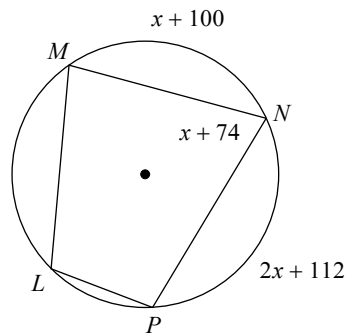

74°

559) Find $m\angle ABC$

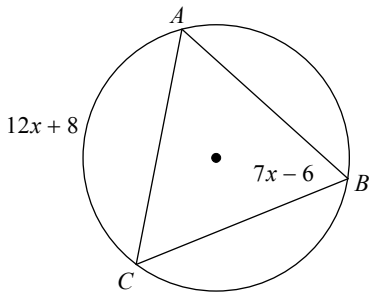

64°

560) Find $m\angle RQS$

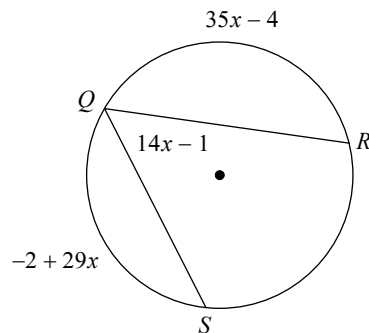

55°

561) Find $m\angle ZTS$

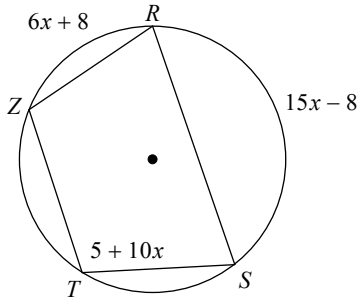

105°

562) Find $m\angle VWX$

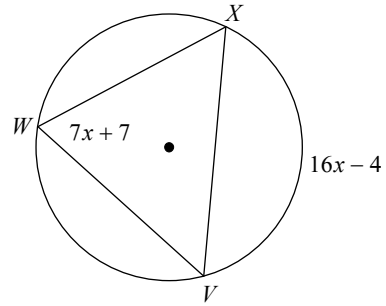

70°

563) Find $m\angle QPR$

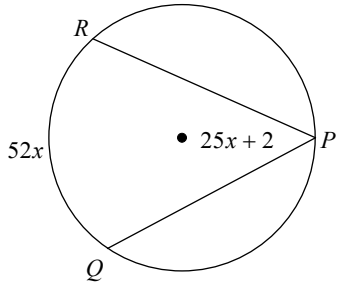

52°

564) Find $m\angle QPR$

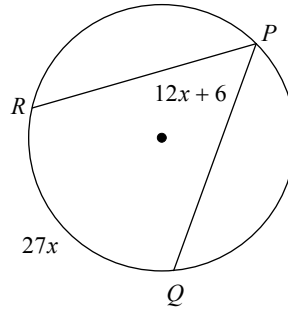

54°

565) Find $m\angle XVW$

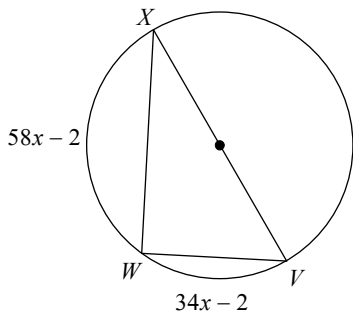

57°

566) Find $m\angle XYW$

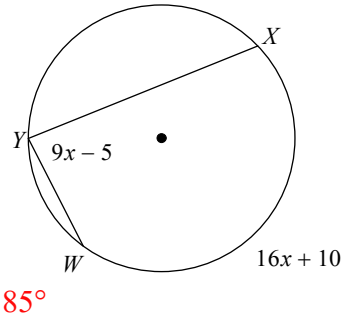

85°

567) Find $m\angle RQS$

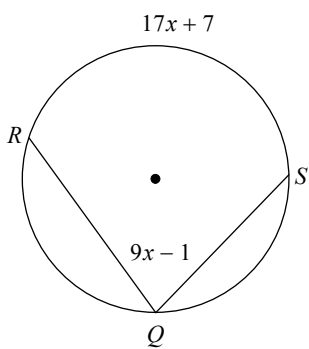

80°

568) Find $m\angle CED$

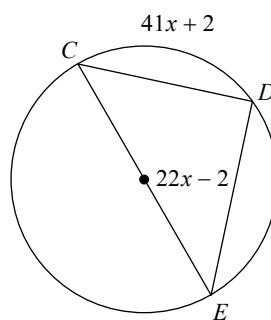

42°

569) Find $m\angle LNM$

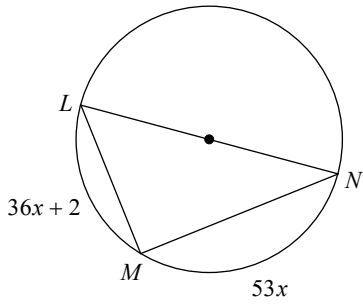

37°

570) Find $m\angle GDC$

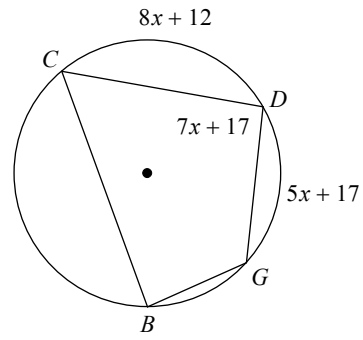

94°

571) Find $m\angle MNL$

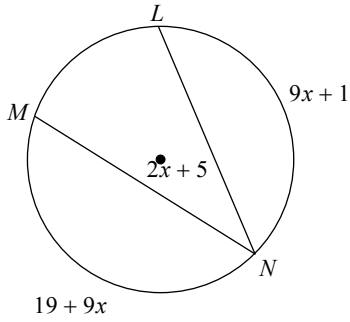

35°

572) Find $m\angle SRT$

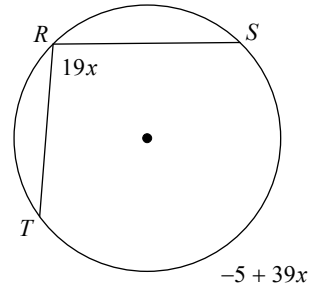

95°

573) Find $m\angle DRQ$

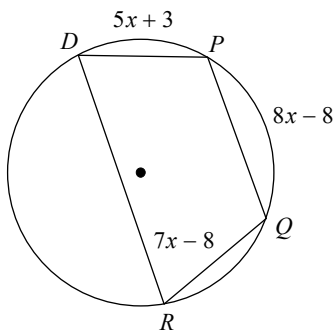

69°

574) Find $m\angle FEG$

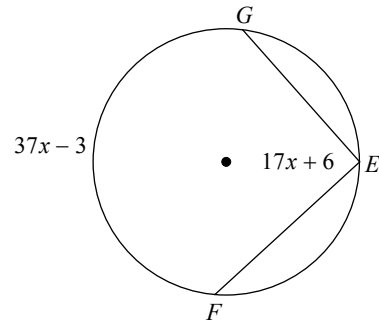

91°

575) Find $m\angle BAC$

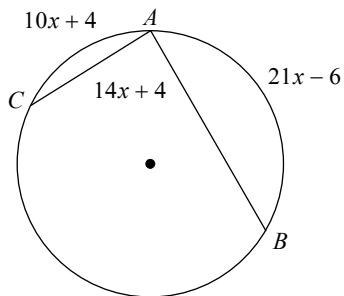

88°

576) Find $m\angle SQR$

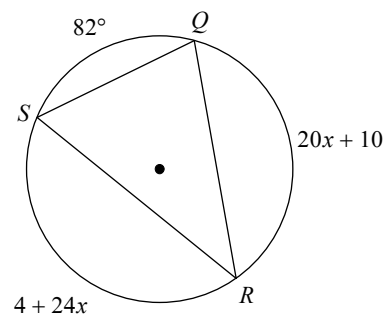

74°

577) Find $m\angle EBC$

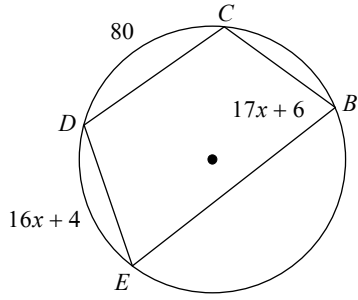

74°

578) Find $m\angle GEF$

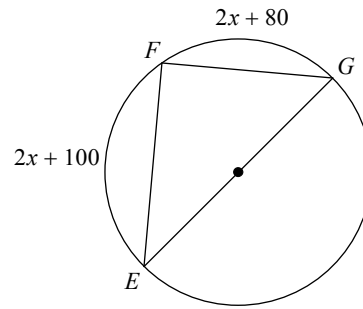

40°

579) Find $m\angle XZY$

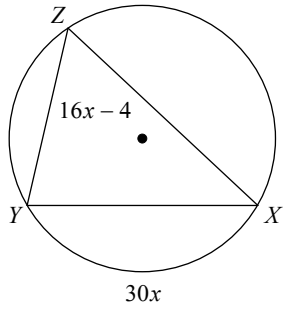

60°

580) Find $m\angle QSR$

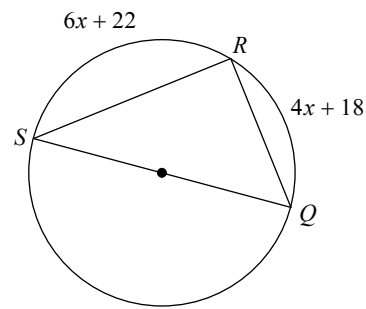

37°

581) Find $m\angle YWX$

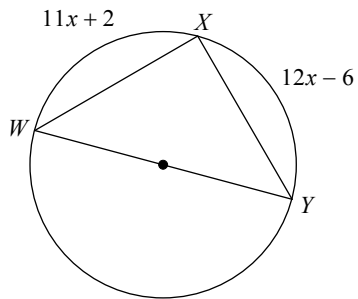

45°

582) Find $m\angle YWX$

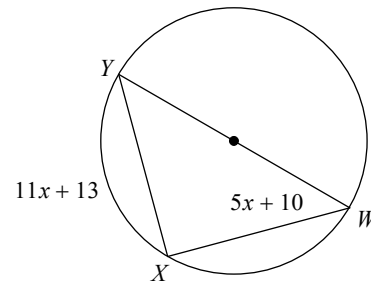

45°

583) Find $m\angle KQR$

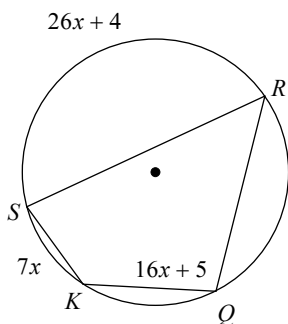

101°

584) Find $m\angle PRQ$

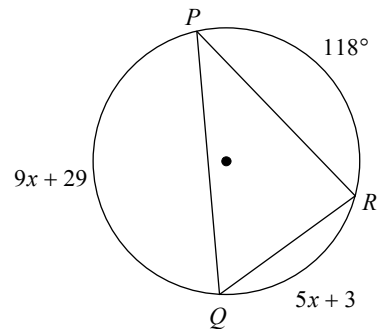

82°

585) Find $m\angle ACB$

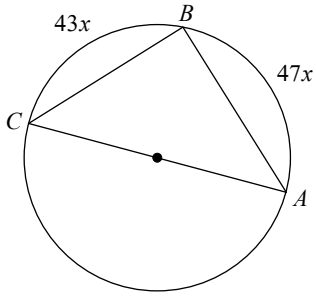

47°

586) Find $m\angle FML$

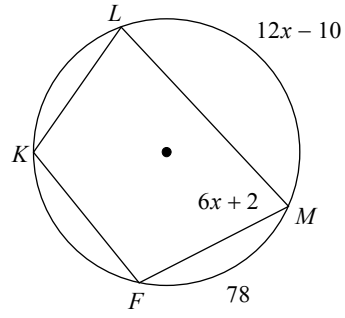

74°

587) Find $m\angle GFH$

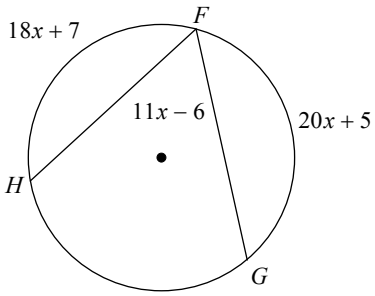

60°

588) Find $m\angle KLJ$

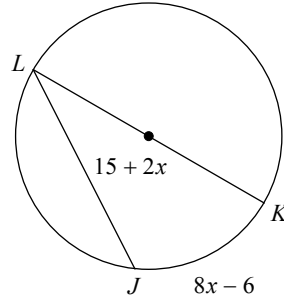

33°

589) Find $m\angle WXV$

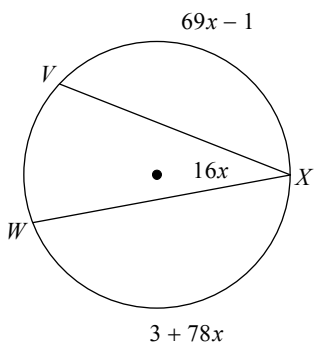

32°

590) Find $m\angle CED$

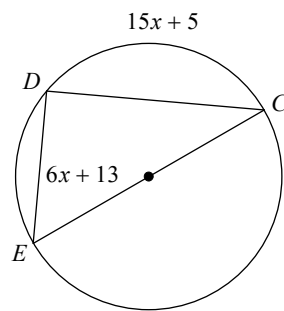

55°

591) Find $m\angle QYP$

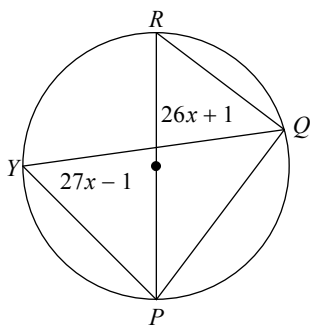

53°

592) Find $m\angle RPQ$

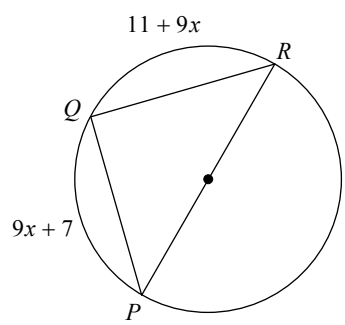

46°

593) Find $m\angle XZY$

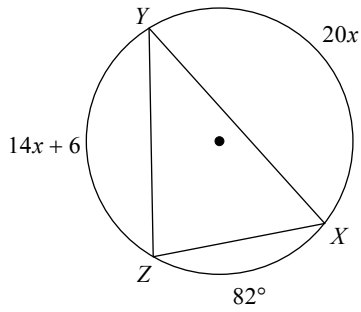

80°

594) Find $m\angle RTS$

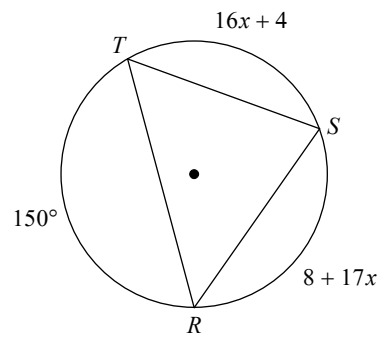

55°

595) Find $m\angle XWY$

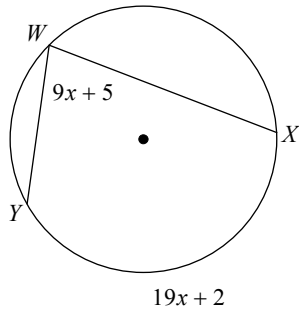

77°

596) Find $m\angle NLM$

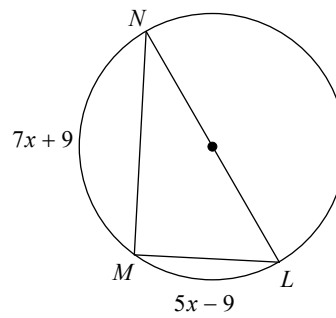

57°

597) Find $m\angle LMK$

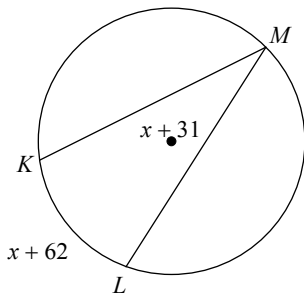

31°

598) Find $m\angle XZY$

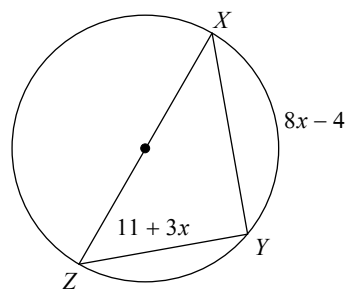

50°

599) Find $m\angle PGF$

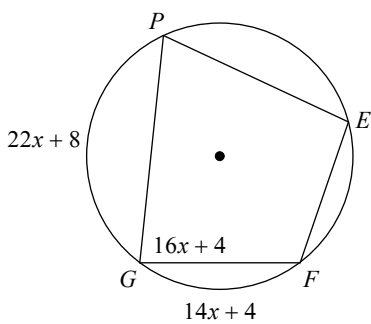

84°

600) Find $m\angle VGF$

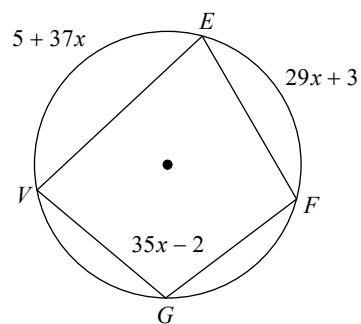

103°

601) Find $m\angle KYX$

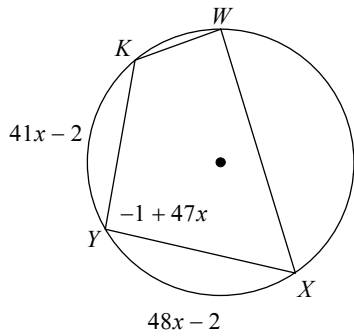

93°

602) Find $m\angle FWH$

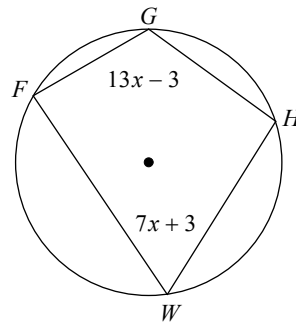

66°

603) Find $m\angle MKL$

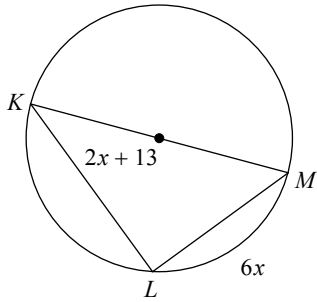

39°

604) Find $m\angle RPQ$

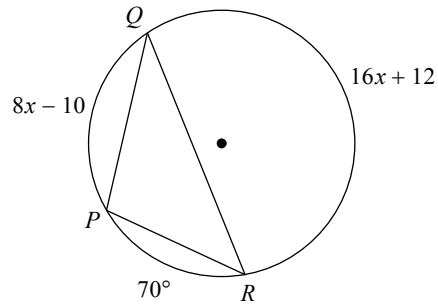

102°

605) Find $m\angle KJL$

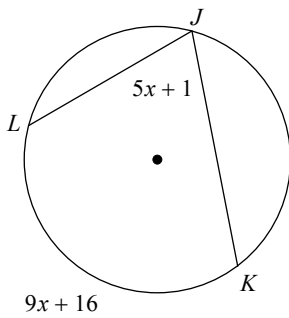

71°

606) Find $m\angle FEG$

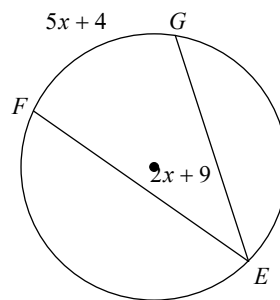

37°

607) Find $m\angle ZXY$

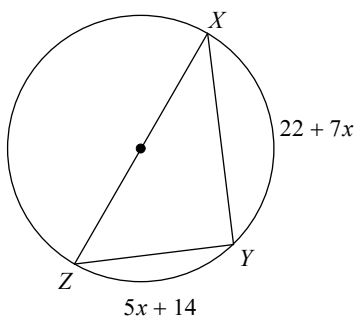

37°

608) Find $m\angle GHF$

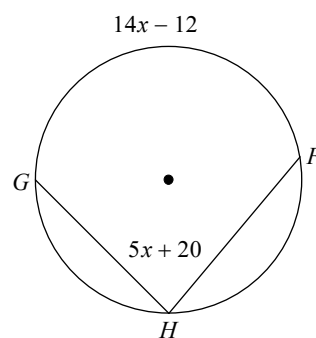

85°

609) Find $m\angle SFT$

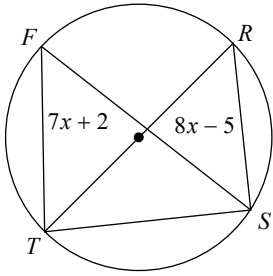

51°

610) Find $m\angle WYX$

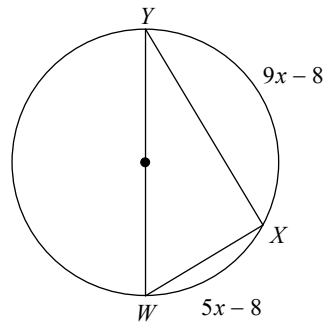

31°

611) Find $m\angle QAP$

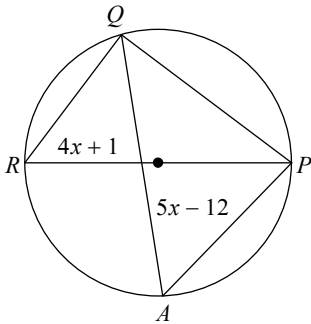

53°

612) Find $m\angle QPR$

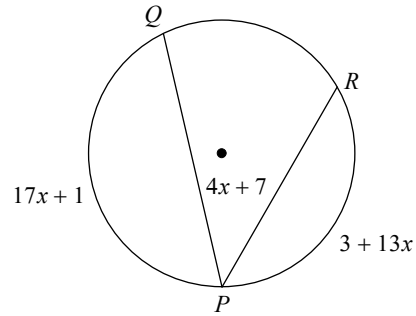

43°

613) Find $m\angle KJL$

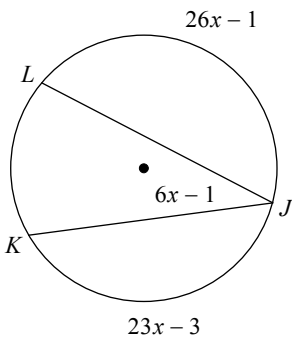

35°

614) Find $m\angle BCA$

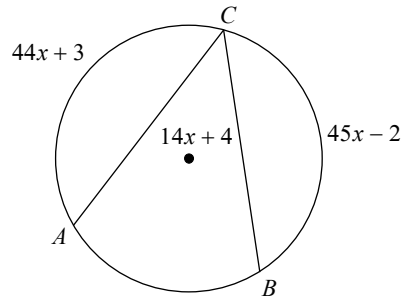

46°

615) Find $m\angle RPQ$

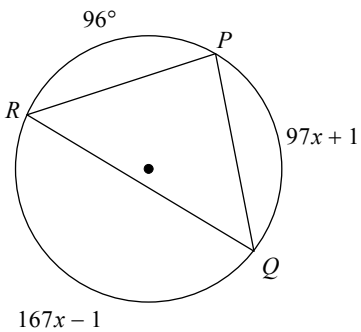

83°

616) Find $m\angle WVX$

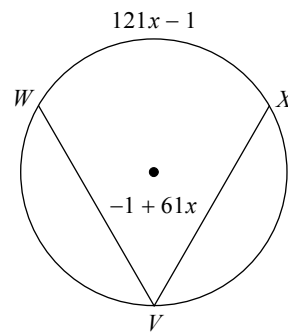

60°

617) Find $m\angle LMK$

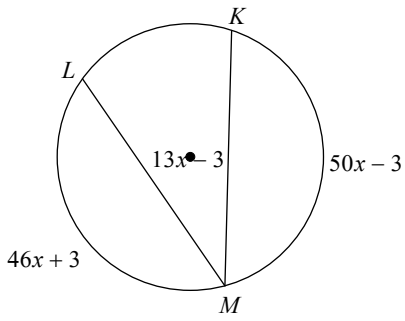

36°

618) Find $m\angle FZY$

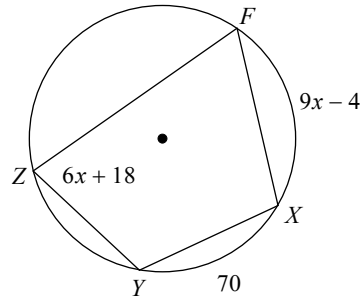

78°

619) Find $m\angle VCB$

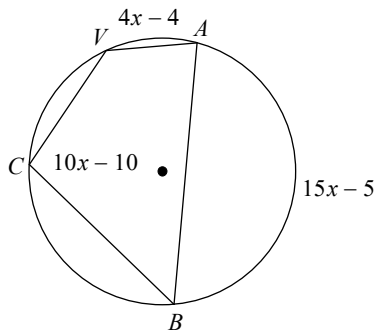

100°

620) Find $m\angle CWX$

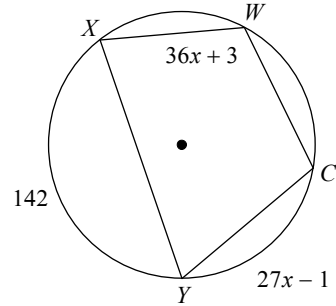

111°

621) Find $m\angle LRN$

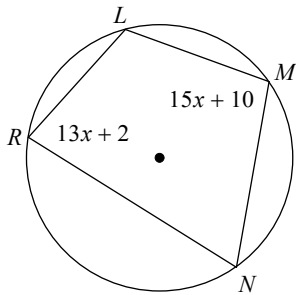

80°

622) Find $m\angle GFH$

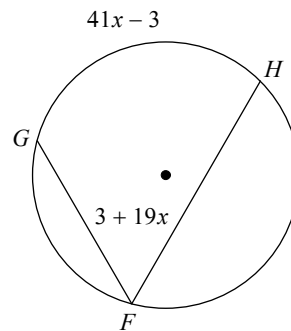

60°

623) Find $m\angle FGE$

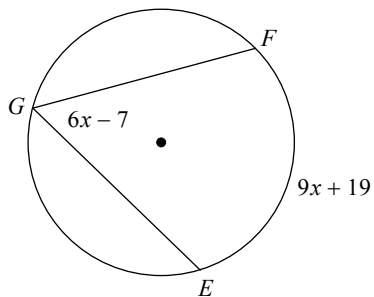

59°

624) Find $m\angle RQS$

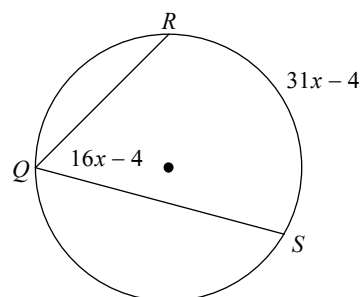

60°

625) Find $m\angle XRS$

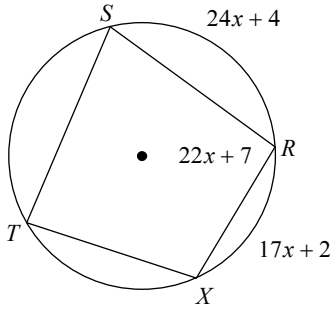

95°

626) Find $m\angle RQS$

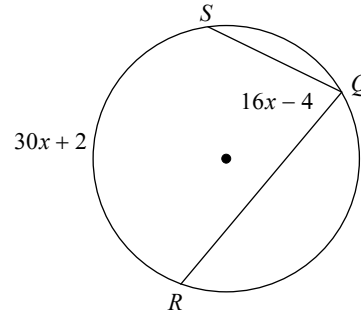

76°

627) Find $m\angle YTS$

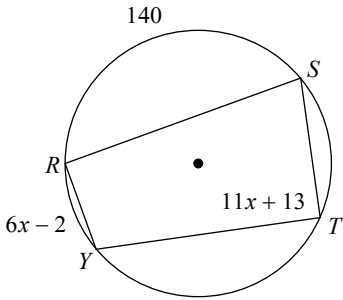

90°

628) Find $m\angle MNL$

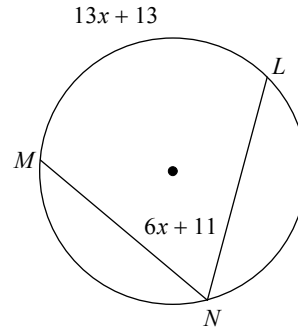

65°

629) Find $m\angle ZXY$

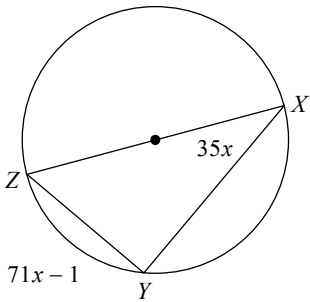

35°

630) Find $m\angle FXW$

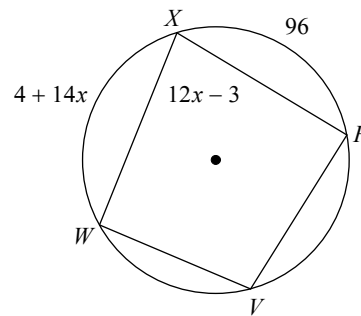

81°

631) Find $m\angle FDE$

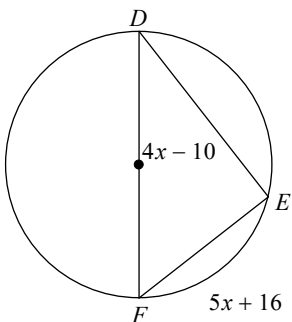

38°

632) Find $m\angle BPC$

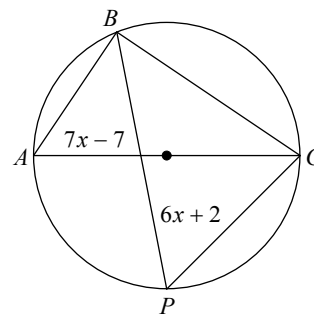

56°

633) Find $m\angle XSR$

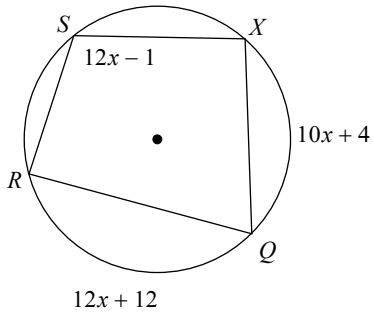

107°

634) Find $m\angle CKL$

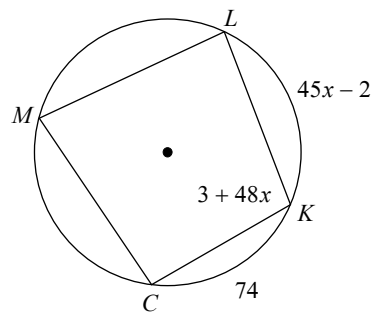

99°

635) Find $m\angle YWX$

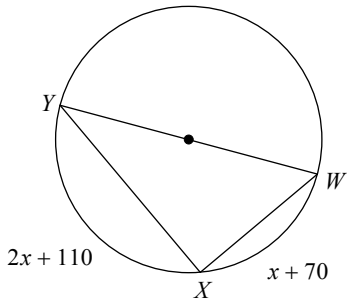

55°

636) Find $m\angle FGH$

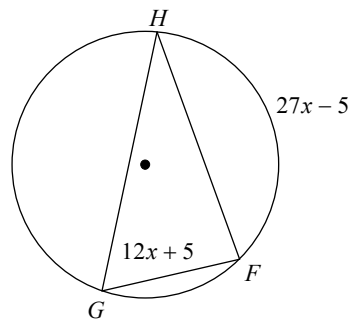

65°

637) Find $m\angle PWR$

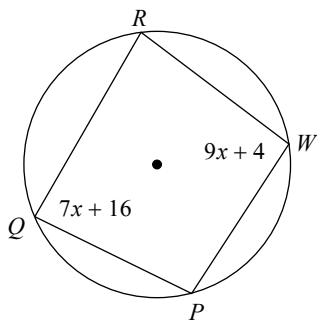

94°

638) Find $m\angle SQR$

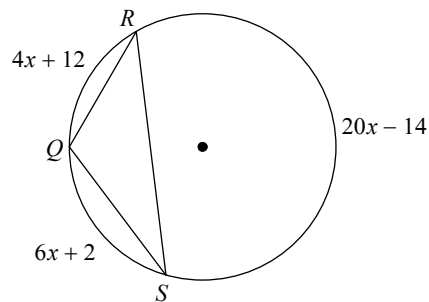

113°

639) Find $m\angle CSR$

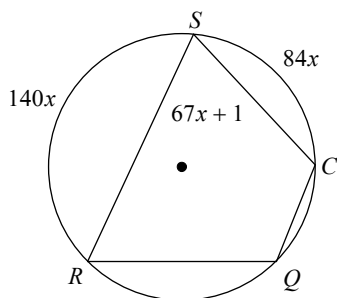

68°

640) Find $m\angle WNX$

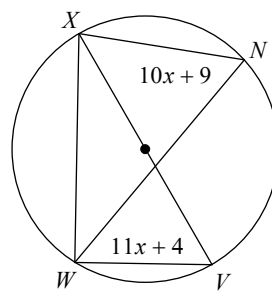

59°

Find the angle measure by solving the system of equations

641)

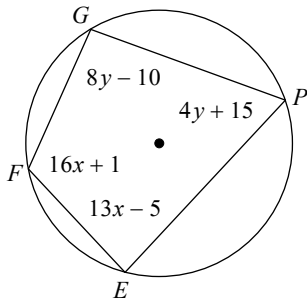

$x = 7, y = 13$

642)

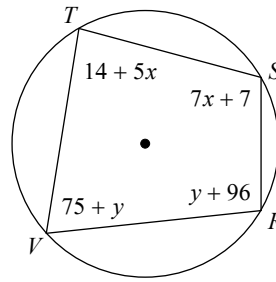

$x = 14, y = 0$

643)

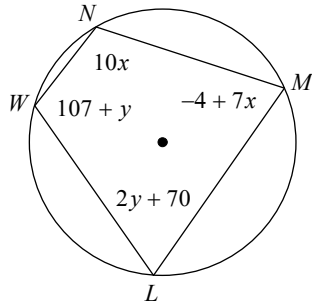

$x = 11, y = 0$

644)

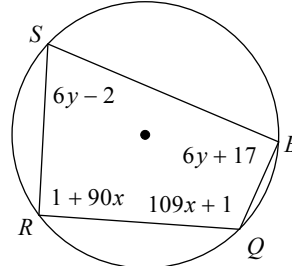

$x = 1, y = 12$

645)

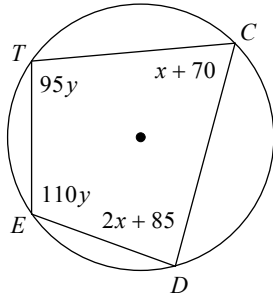

$x = 0, y = 1$

646)

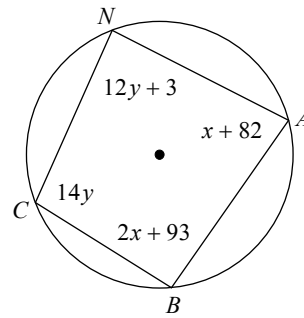

$x = 0, y = 7$

647)

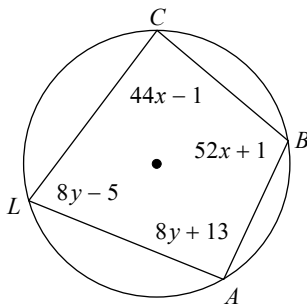

$x = 2, y = 10$

648)

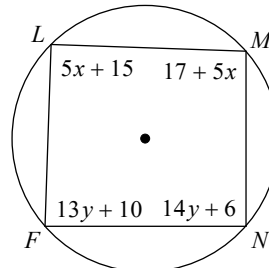

$x = 15, y = 6$

649)

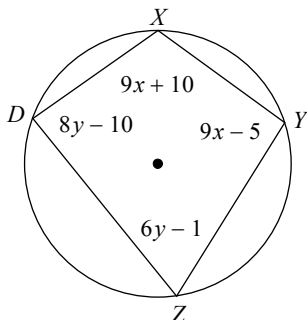

$x = 11, y = 12$

650)

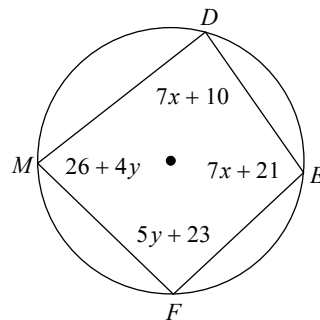

$x = 11, y = 14$

651)

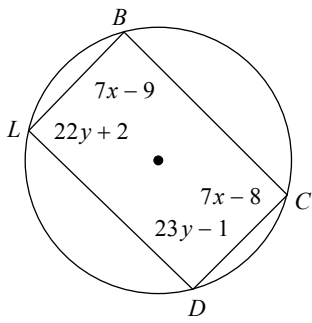

$$x = 14, y = 4$$

652)

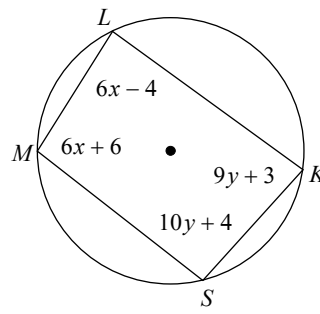

$$x = 15, y = 9$$

653)

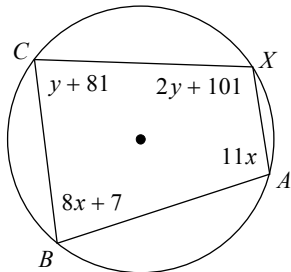

$$x = 9, y = 0$$

654)

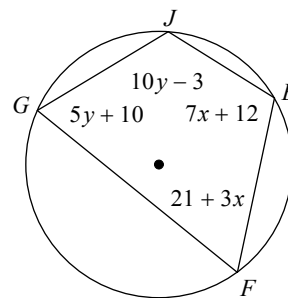

$$x = 14, y = 12$$

655)

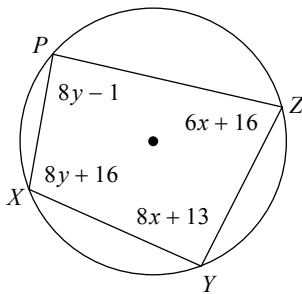

$$x = 10, y = 11$$

656)

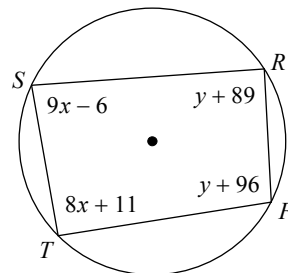

$$x = 10, y = 0$$

657)

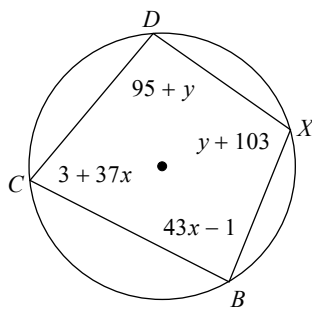

$$x = 2, y = 0$$

658)

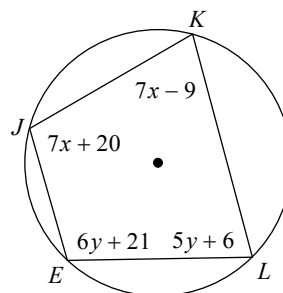

$$x = 12, y = 14$$

659)

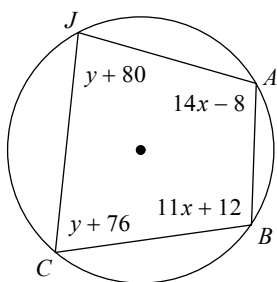

$$x = 8, y = 0$$

660)

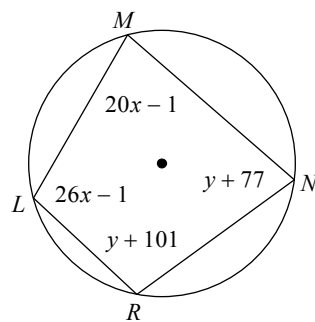

$$x = 4, y = 0$$

661)

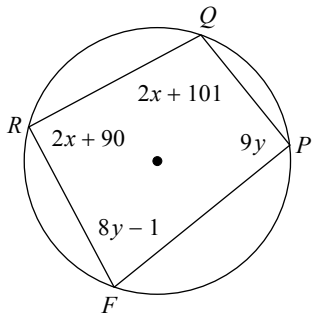

$$x = 0, y = 10$$

662)

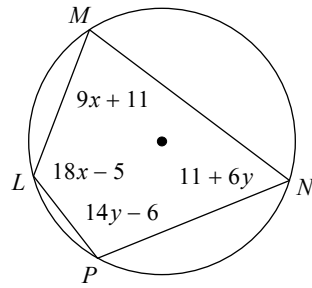

$$x = 7, y = 8$$

663)

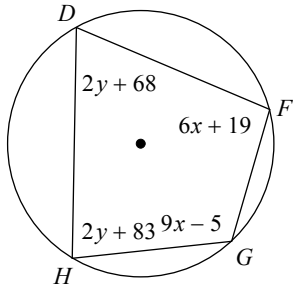

$$x = 13, y = 0$$

664)

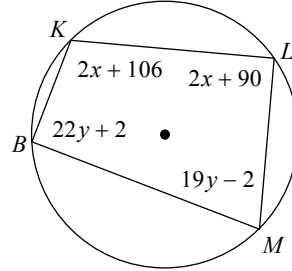

$$x = 0, y = 4$$

665)

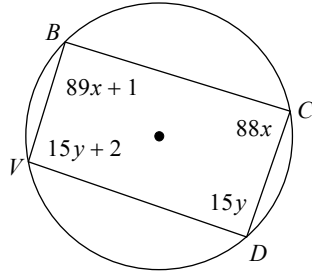

$$x = 1, y = 6$$

666)

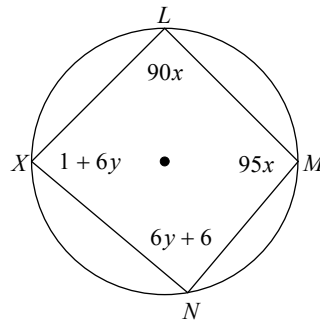

$$x = 1, y = 14$$

667)

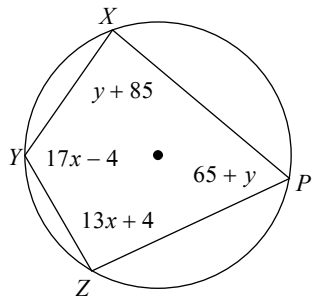

$$x = 7, y = 0$$

668)

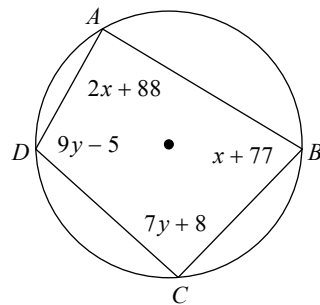

$$x = 0, y = 12$$

669)

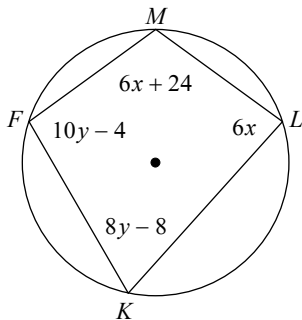

$$x = 14, y = 10$$

670)

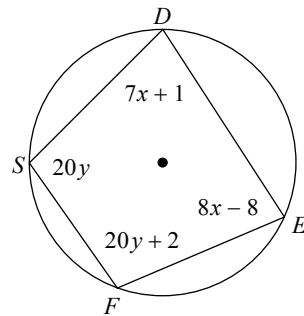

$$x = 11, y = 5$$

671)

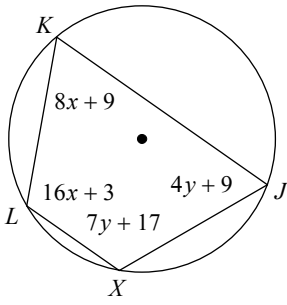

$$x = 7, y = 14$$

672)

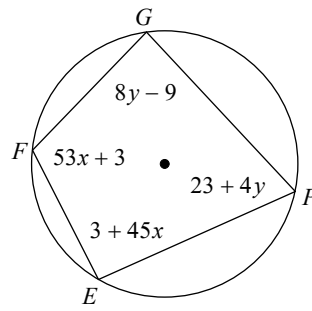

$$x = 2, y = 12$$

673)

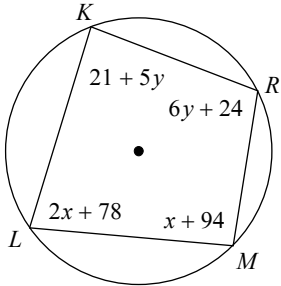

$$x = 0, y = 13$$

674)

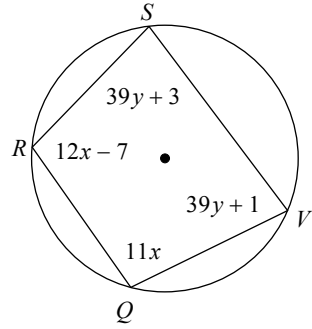

$$x = 9, y = 2$$

675)

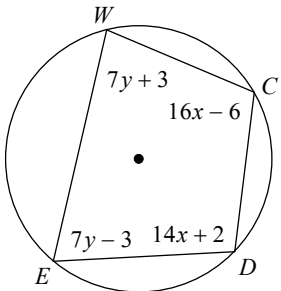

$$x = 7, y = 11$$

676)

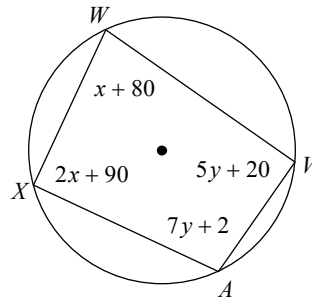

$$x = 0, y = 14$$

677)

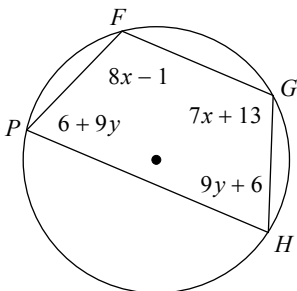

$$x = 14, y = 7$$

678)

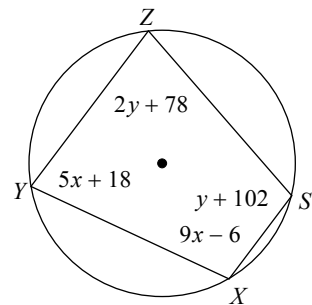

$$x = 12, y = 0$$

679)

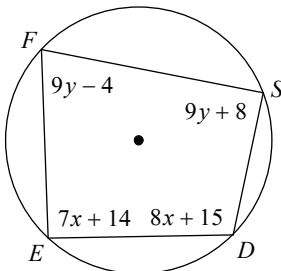

$$x = 11, y = 9$$

680)

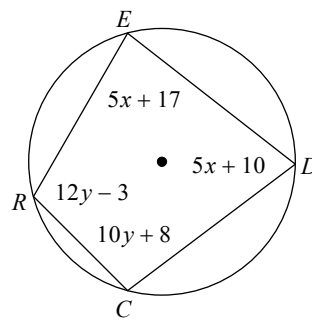

$$x = 13, y = 9$$

681)

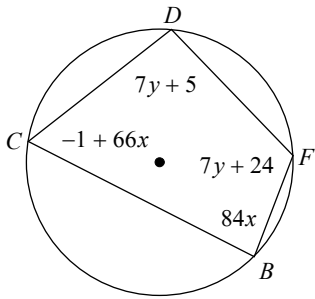

$$x = 1, y = 13$$

682)

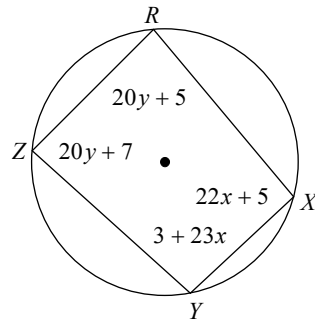

$$x = 4, y = 4$$

683)

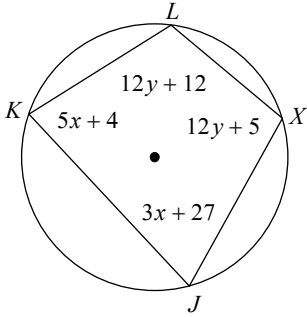

$$x = 15, y = 8$$

684)

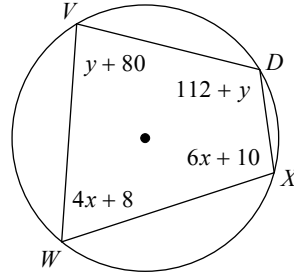

$$x = 15, y = 0$$

685)

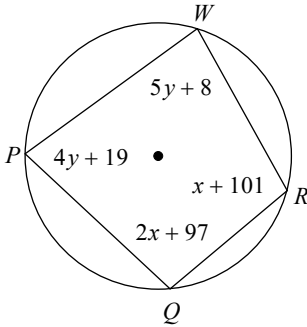

$$x = 0, y = 15$$

686)

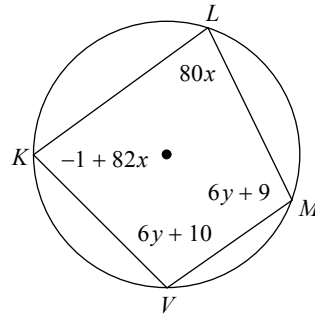

$$x = 1, y = 15$$

Find the angle measure by solving the unknown

687)

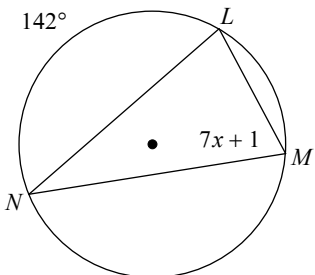

10

688)

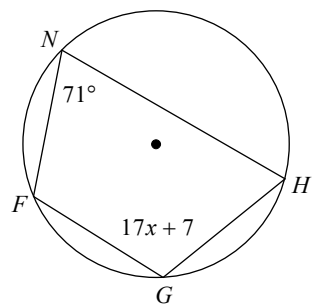

6

689)

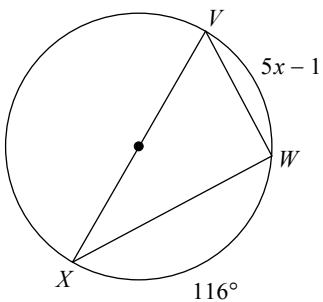

13

690)

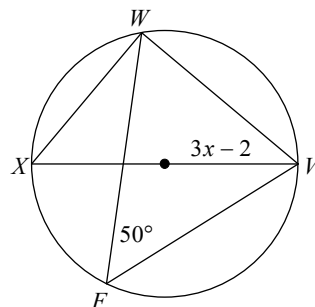

14

691)

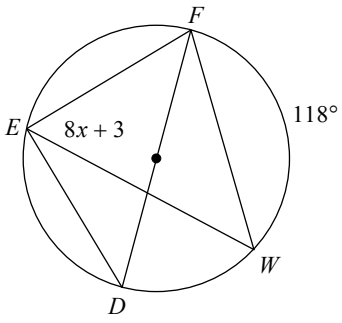

7

692)

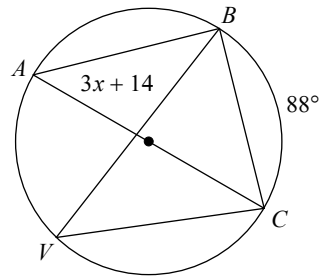

10

693)

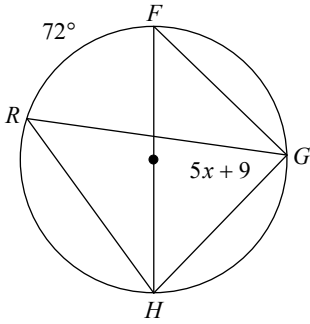

9

694)

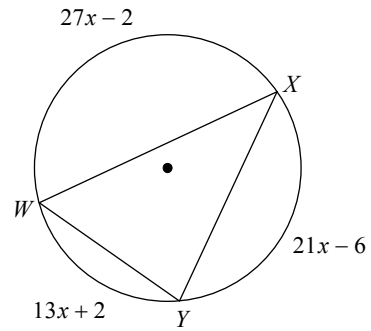

6

695)

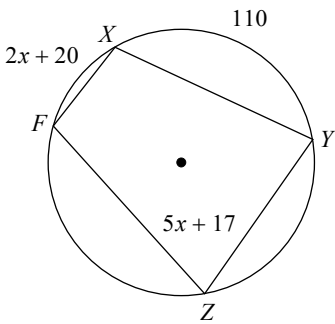

12

696)

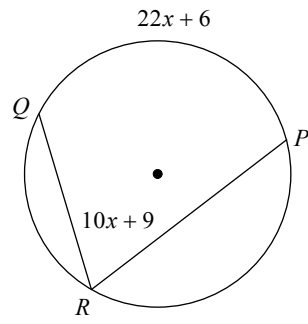

6

697)

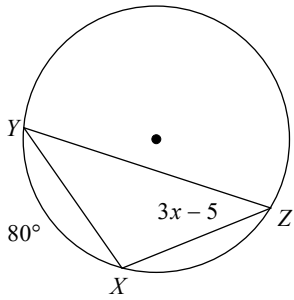

15

698)

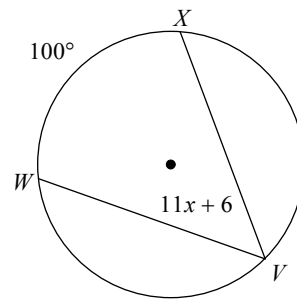

4

699)

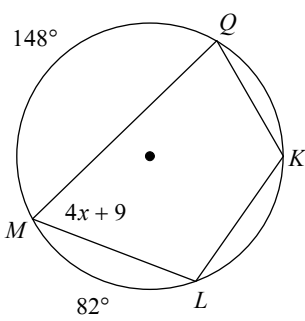

14

700)

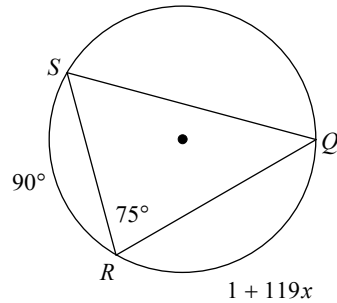

1

701)

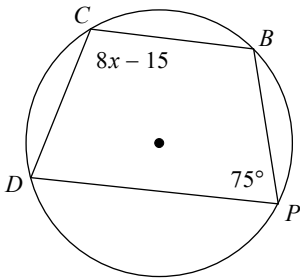

15

702)

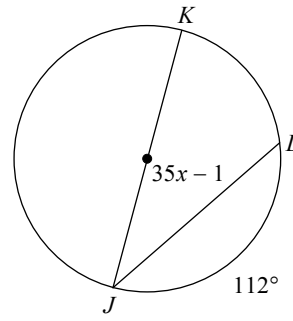

1

703)

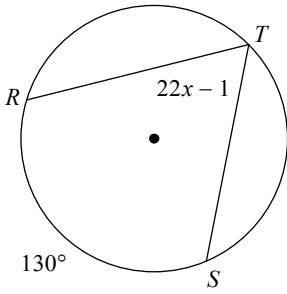

3

704)

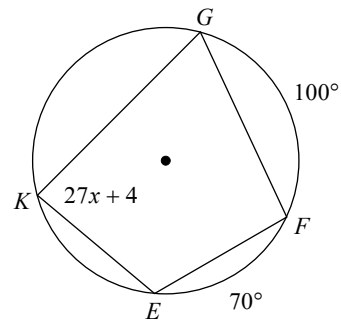

3

705)

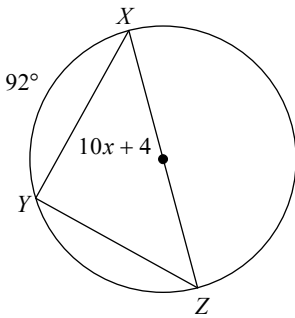

4

706)

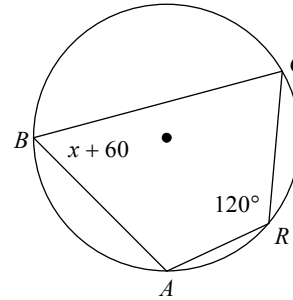

0

707)

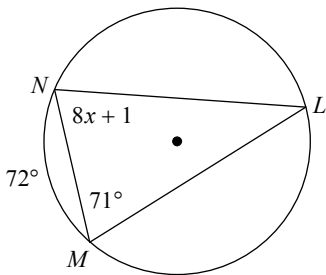

9

708)

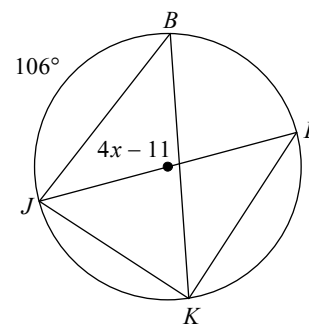

12

709)

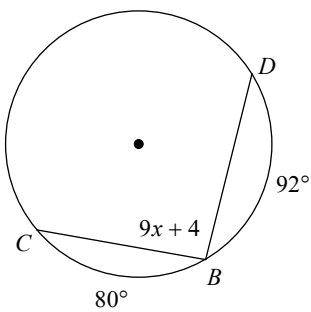

10

710)

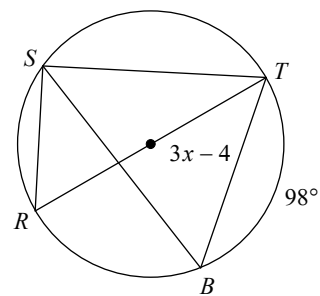

15

711)

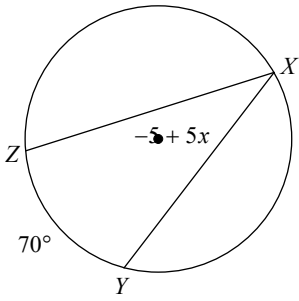

8

712)

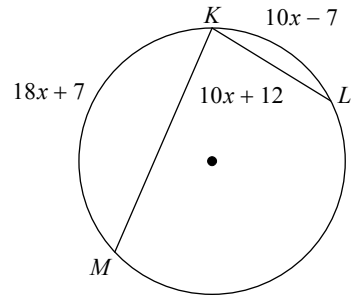

7

713)

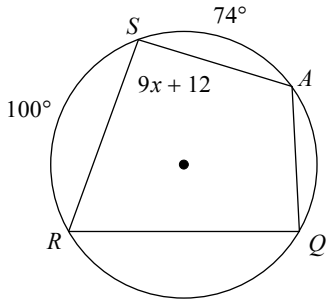

9

714)

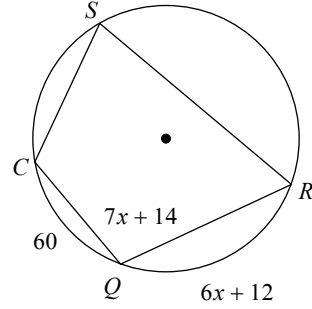

13

715)

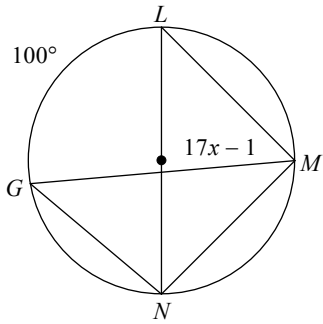

3

716)

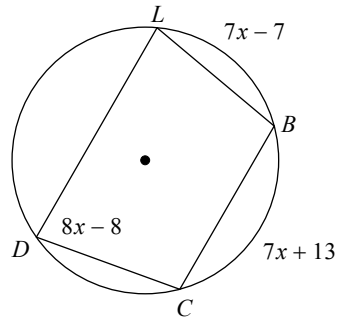

11

717)

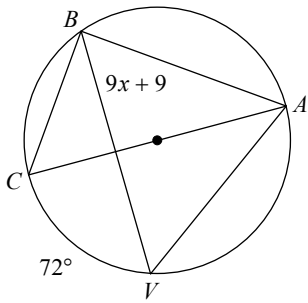

5

718)

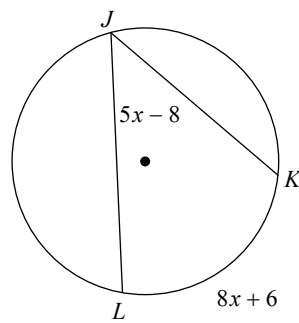

11

719)

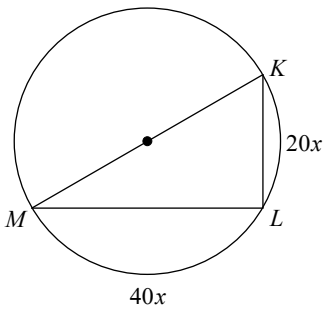

3

720)

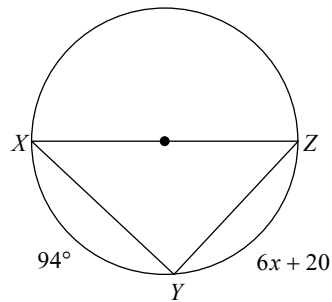

11

721)

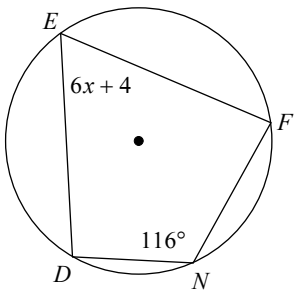

10

722)

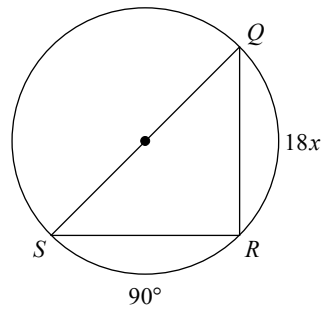

5

723)

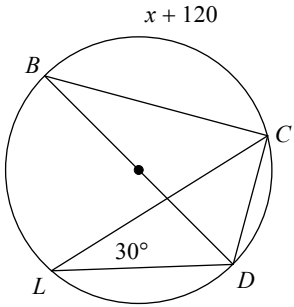

0

724)

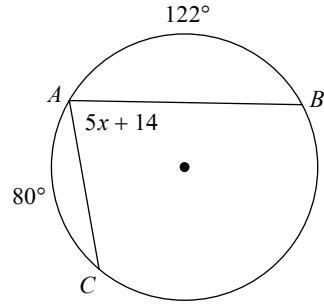

13

725)

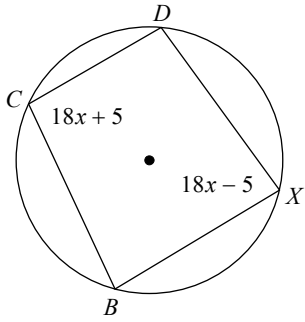

5

726)

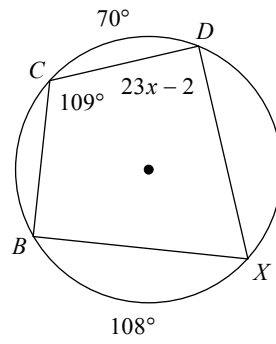

4

727)

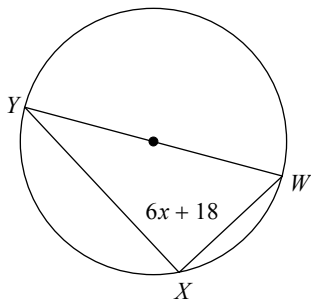

12

728)

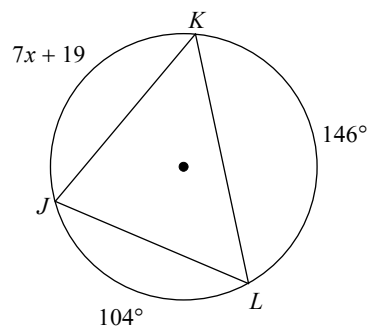

13

729)

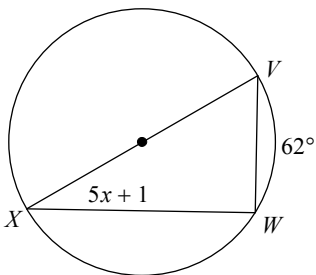

6

730)

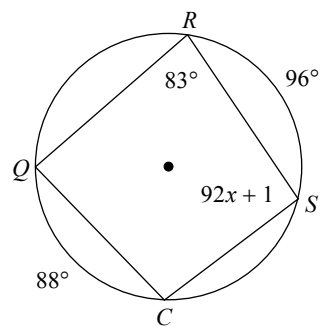

1

731)

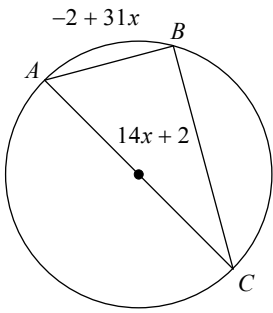

2

732)

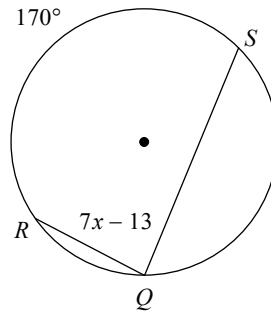

14

733)

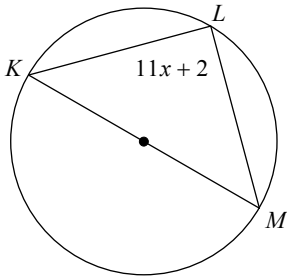

8

734)

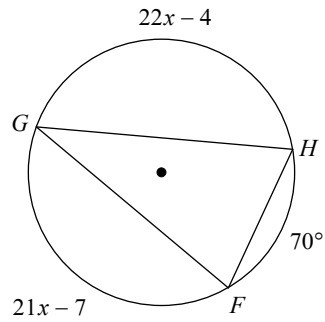

7

735)

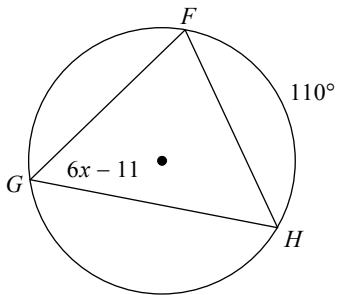

11

736)

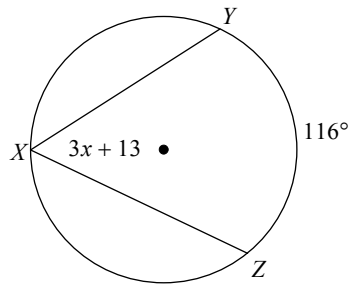

15

737)

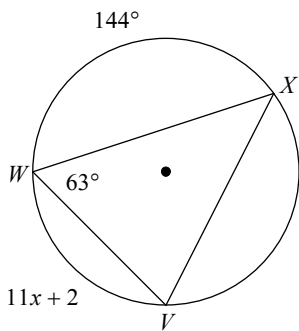

8

738)

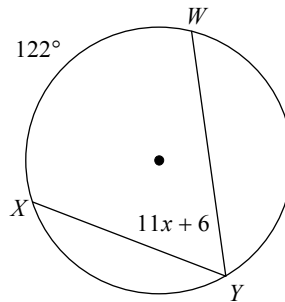

5

739)

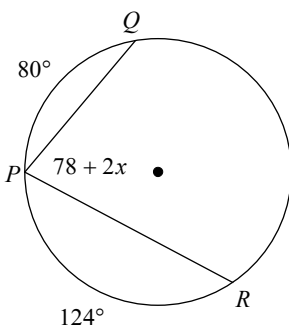

0

740)

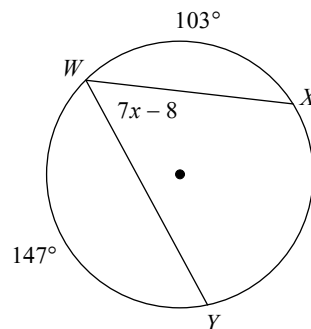

9

741)

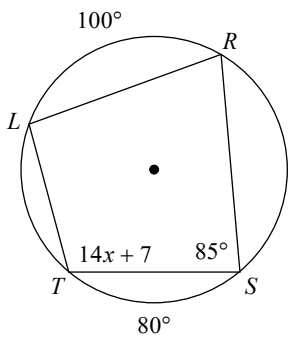

7

742)

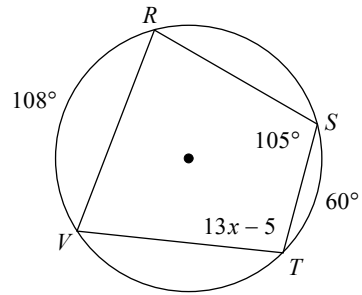

8

743)

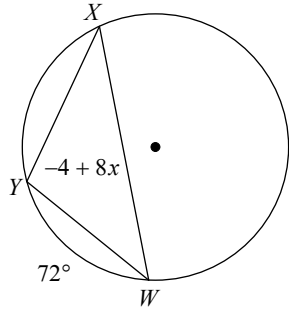

5

744)

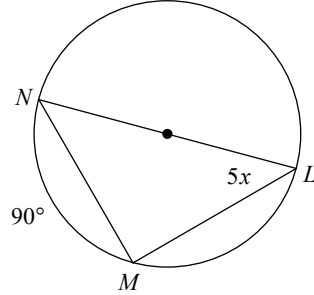

9

745)

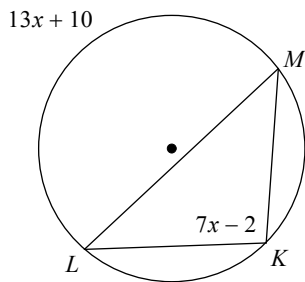

14

746)

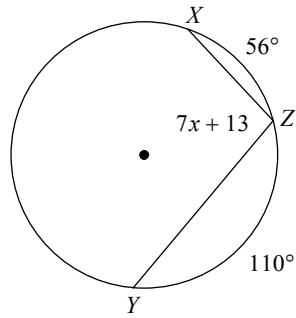

12

747)

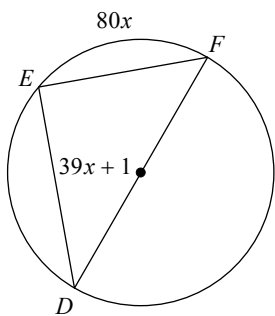

1

748)

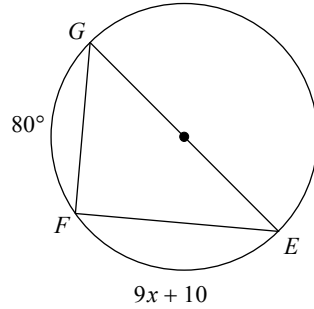

10

749)

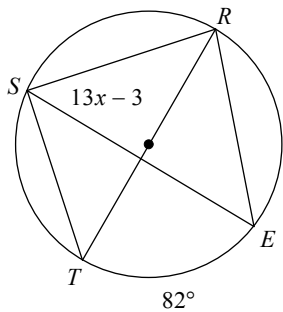

4

750)

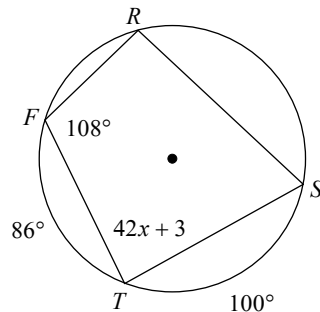

2

751)

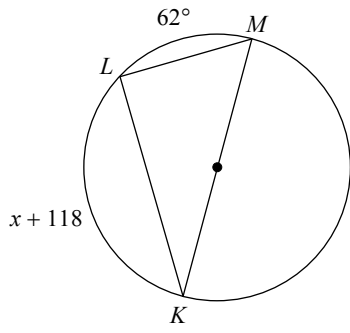

0

752)

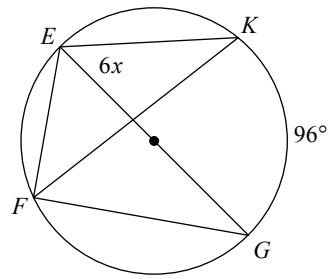

8

753)

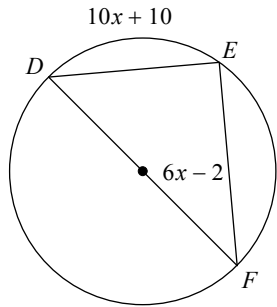

7

754)

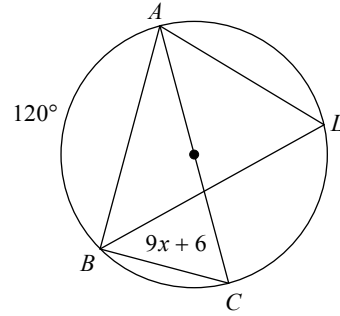

6

755)

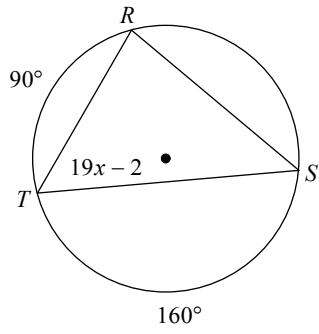

3

756)

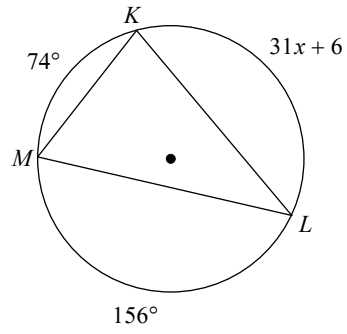

4

757)

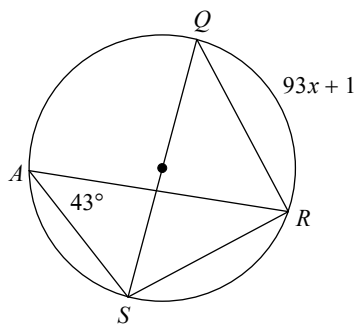

1

758)

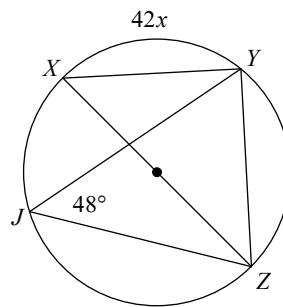

2

759)

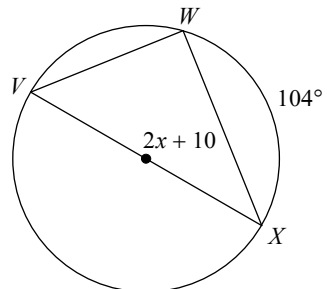

14

760)

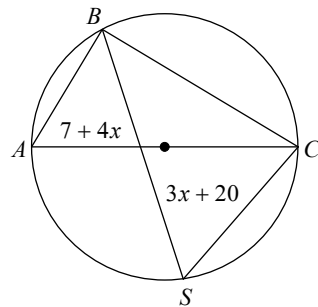

13

761)

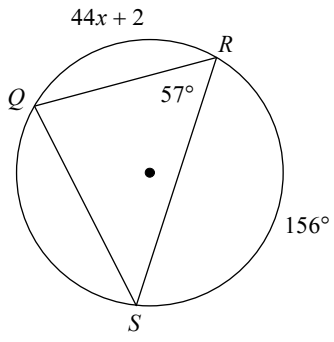

2

762)

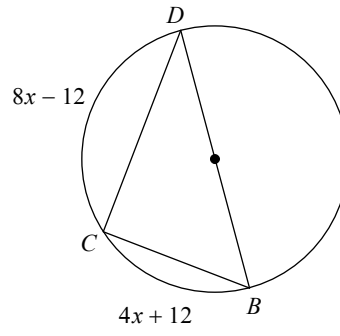

15

763)

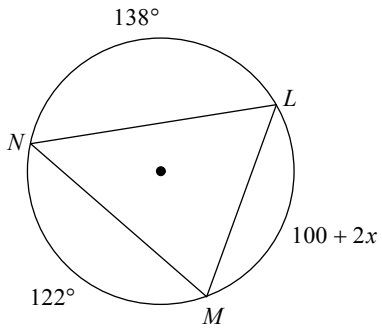

0

764)

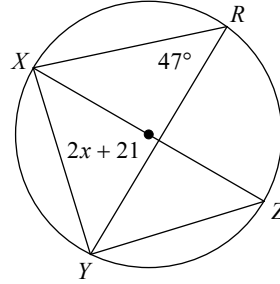

11

765)

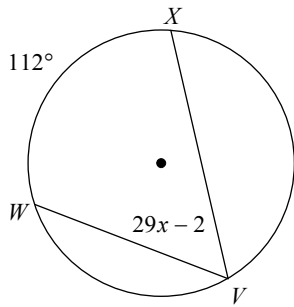

2

766)

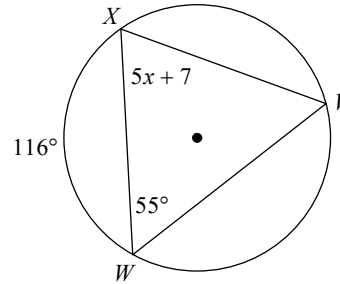

12

767) Find $m\angle KJL$

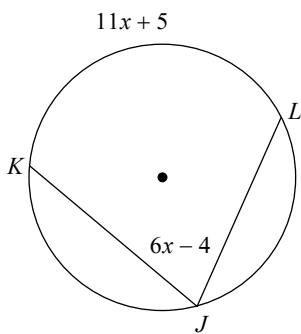

74°

768) Find $m\angle WVX$

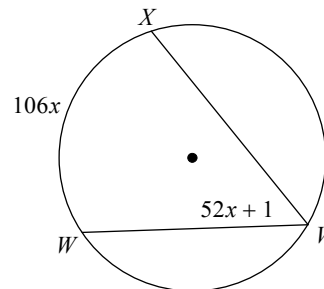

53°

769) Find $m\angle YXZ$

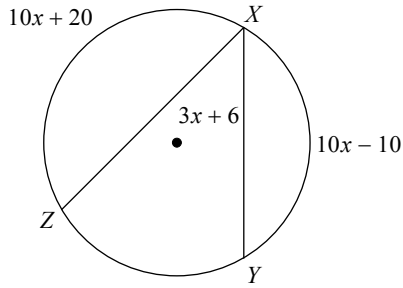

45°

770) Find $m\angle FSG$

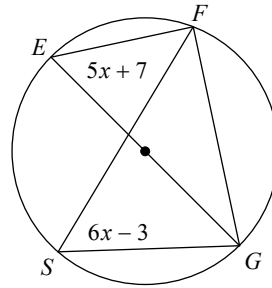

57°

771) Find $m\angle RTS$

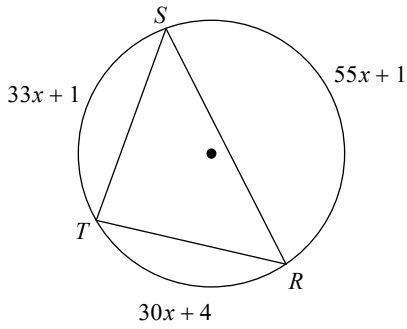

83°

772) Find $m\angle MKL$

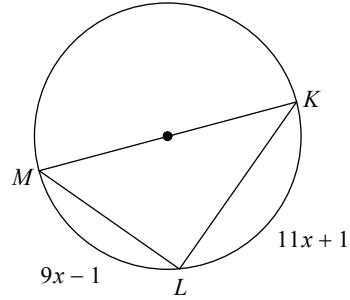

40°

773) Find $m\angle BDC$

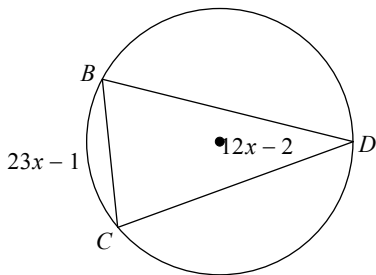

34°

774) Find $m\angle GHF$

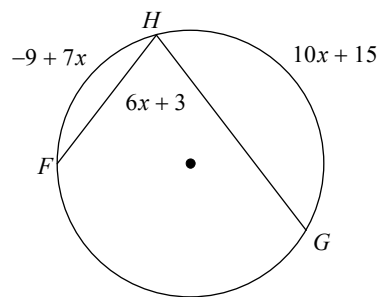

75°

775) Find $m\angle YWX$

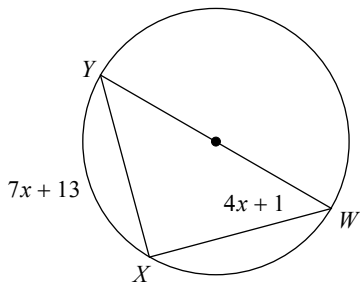

45°

776) Find $m\angle XVW$

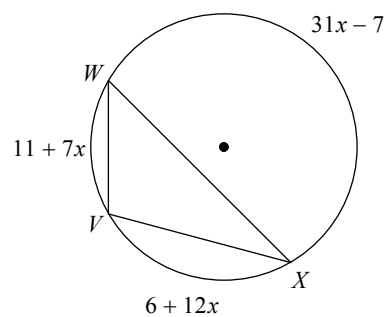

105°

777) Find $m\angle YZX$

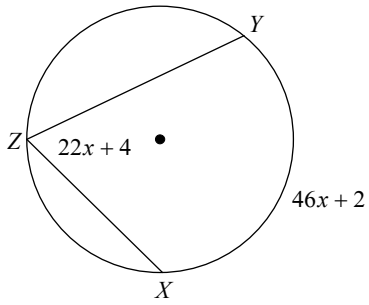

70°

778) Find $m\angle WXV$

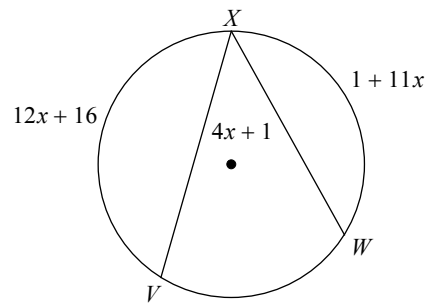

45°

779) Find $m\angle JZY$

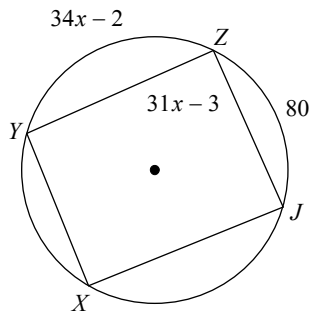

90°

780) Find $m\angle BAC$

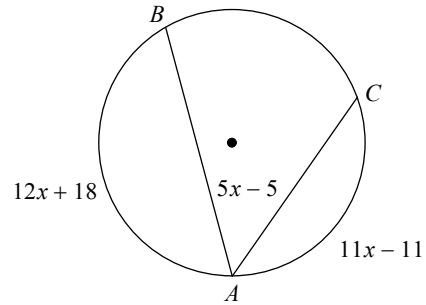

50°

781) Find $m\angle KYX$

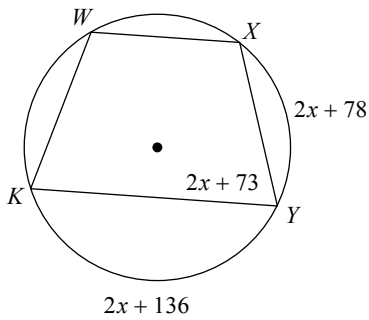

73°

782) Find $m\angle LCB$

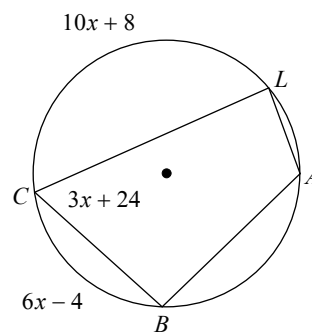

66°

783) Find $m\angle EDF$

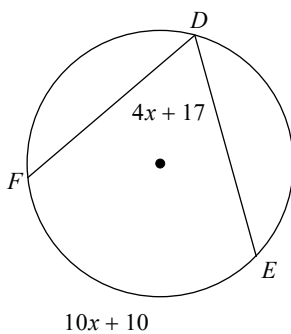

65°

784) Find $m\angle EDF$

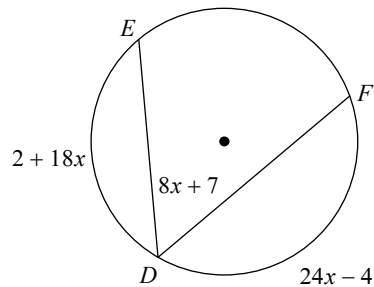

55°

785) Find $m\angle DLM$

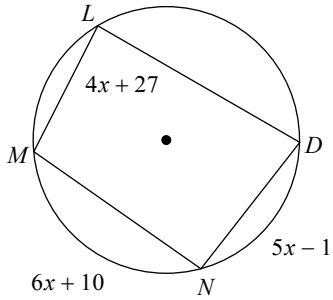

87°

786) Find $m\angle MLN$

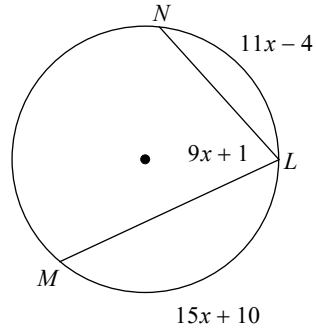

73°

787) Find $m\angle FEG$

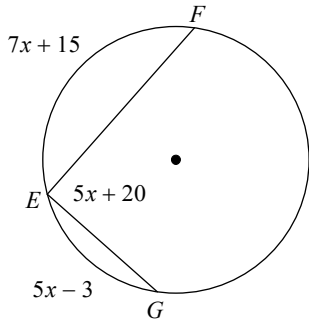

90°

788) Find $m\angle QZY$

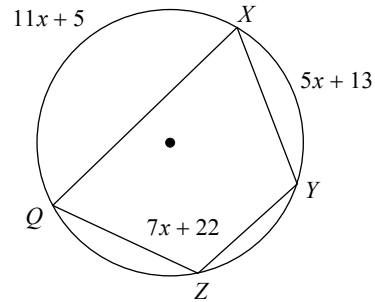

113°

789) Find $m\angle ZXY$

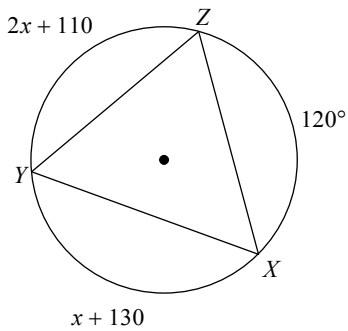

55°

790) Find $m\angle SQR$

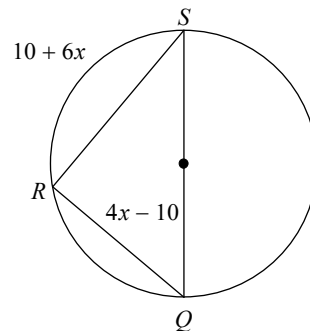

50°

791) Find $m\angle EGF$

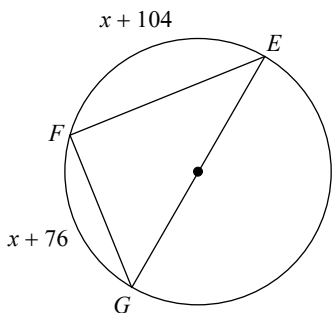

52°

792) Find $m\angle NFE$

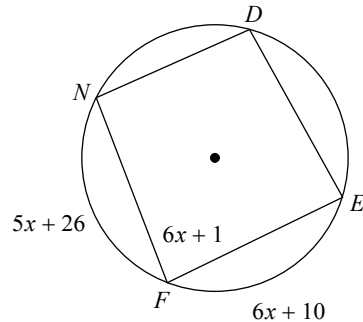

85°

793) Find $m\angle EFD$

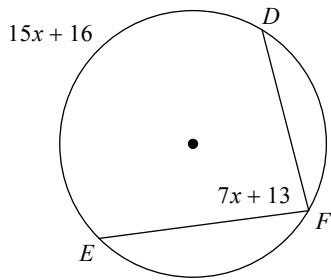

83°

794) Find $m\angle CAB$

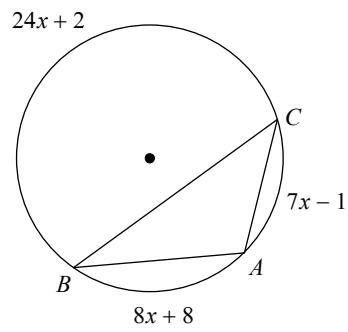

109°

795) Find $m\angle WQY$

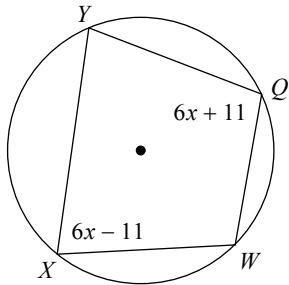

101°

796) Find $m\angle EDF$

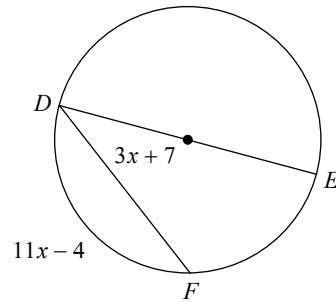

37°

797) Find $m\angle SJR$

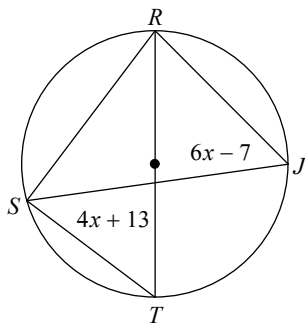

53°

798) Find $m\angle YZX$

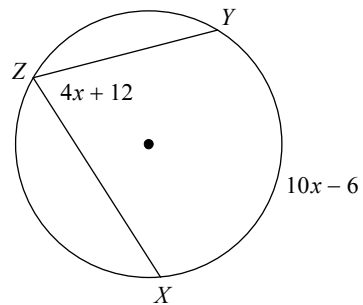

72°

799) Find $m\angle RQS$

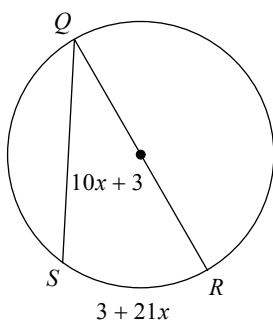

33°

800) Find $m\angle RES$

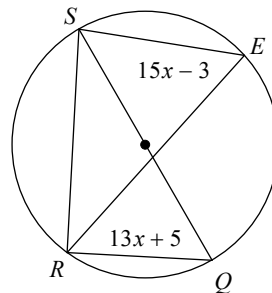

57°

801) Find $m\angle ACB$

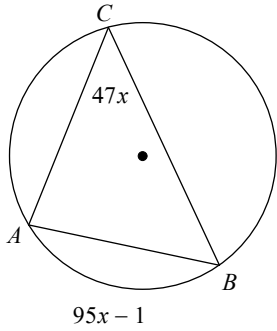

47°

802) Find $m\angle ACB$

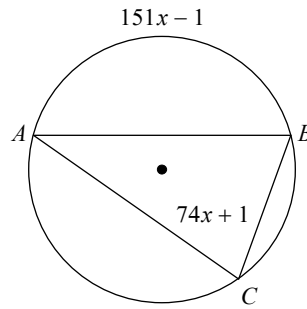

75°

803) Find $m\angle DZY$

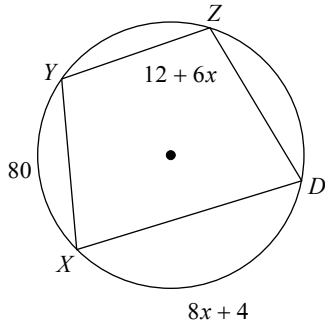

102°

804) Find $m\angle DJK$

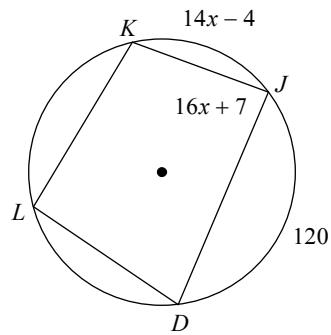

87°

805) Find $m\angle EFD$

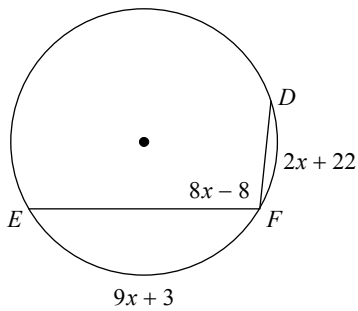

96°

806) Find $m\angle LMK$

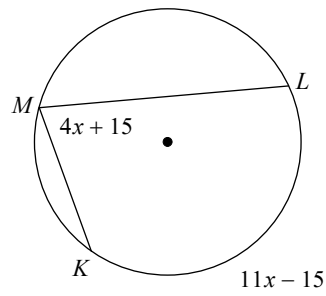

75°

807) Find $m\angle CDB$

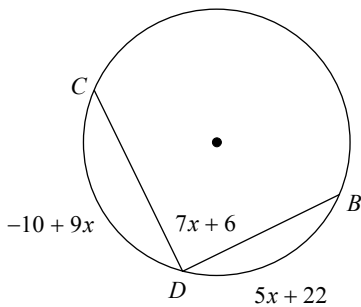

90°

808) Find $m\angle CAB$

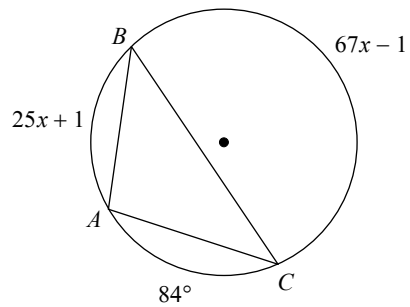

100°

809) Find $m\angle SQR$

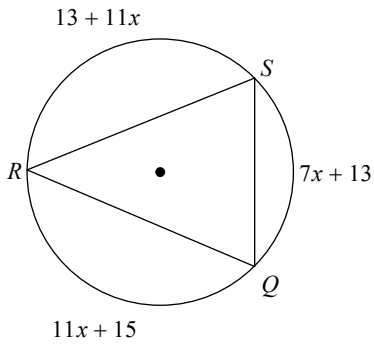

67°

810) Find $m\angle WKY$

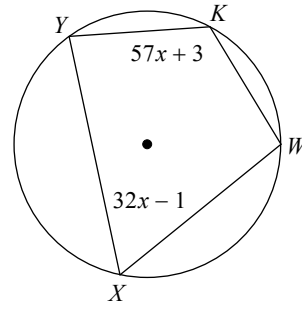

117°

811) Find $m\angle LAM$

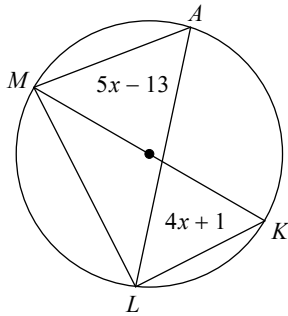

57°

812) Find $m\angle BCA$

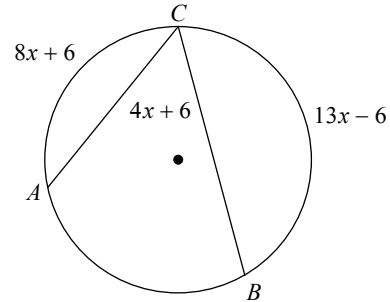

54°

813) Find $m\angle NLM$

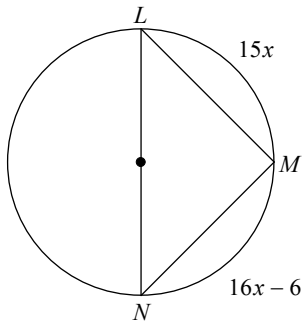

45°

814) Find $m\angle ZXY$

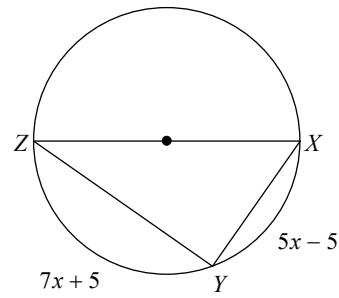

55°

815) Find $m\angle EQR$

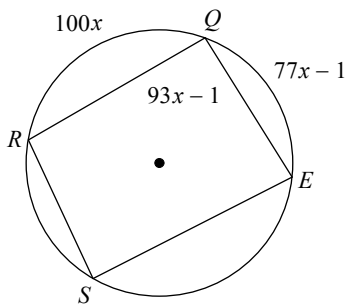

92°

816) Find $m\angle WYX$

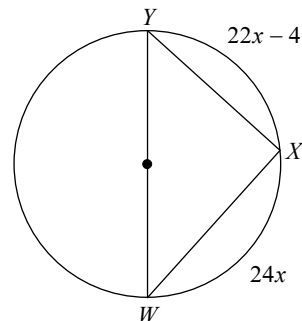

48°

817) Find $m\angle YXZ$

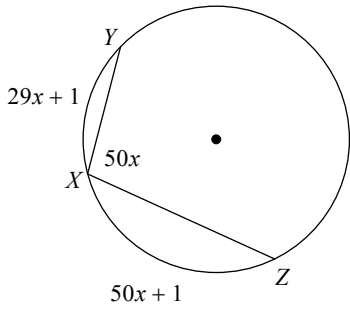

100°

818) Find $m\angle KGF$

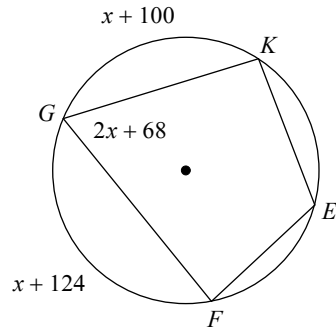

68°

819) Find $m\angle KDC$

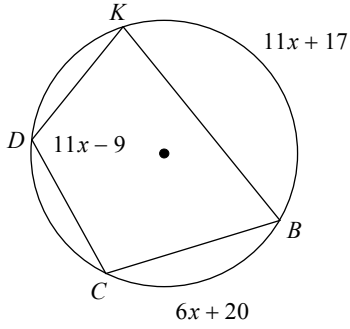

112°

820) Find $m\angle LQJ$

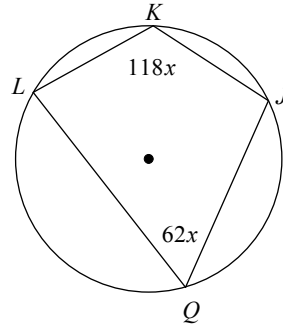

62°

821) Find $m\angle TRS$

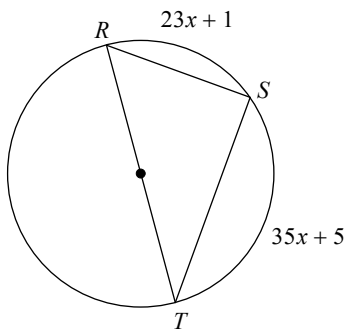

55°

822) Find $m\angle ACB$

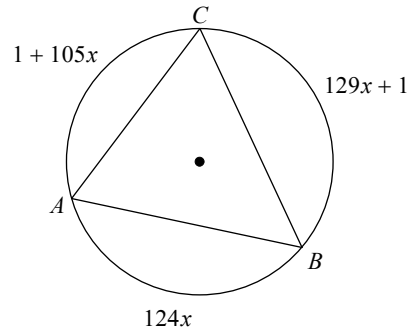

62°

823) Find $m\angle DBC$

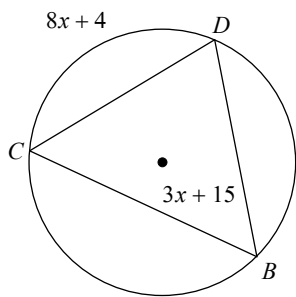

54°

824) Find $m\angle CKD$

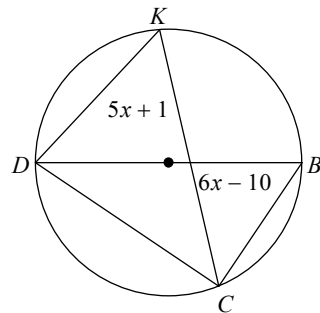

56°

825) Find $m\angle CFD$

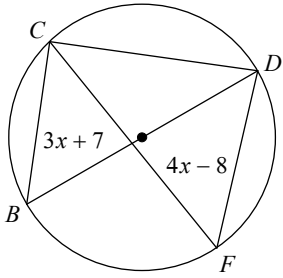

52°

826) Find $m\angle RNM$

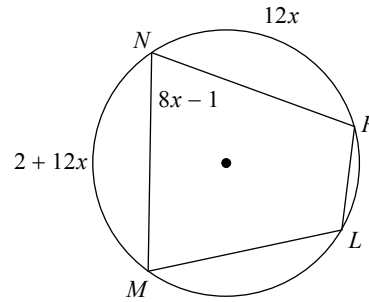

71°

827) Find $m\angle WEF$

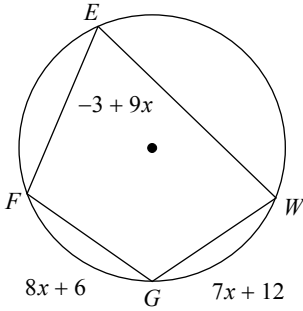

69°

828) Find $m\angle KLJ$

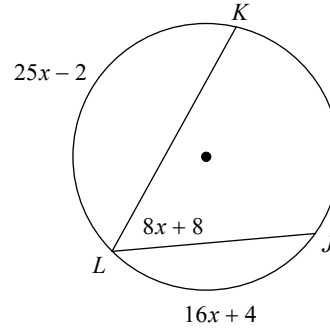

56°

829) Find $m\angle PAR$

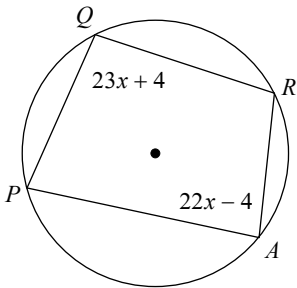

84°

830) Find $m\angle NBC$

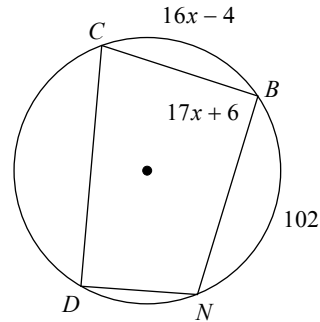

91°

831) Find $m\angle LMK$

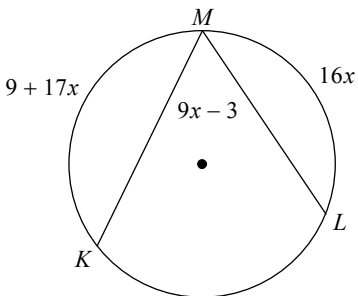

60°

832) Find $m\angle HQR$

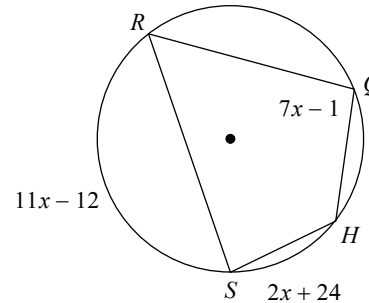

97°

833) Find $m\angle XWY$

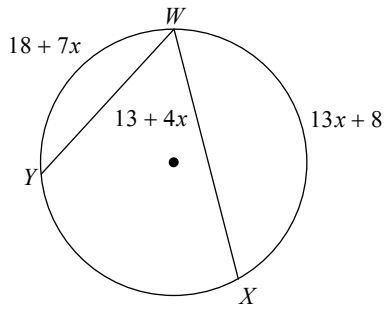

57°

834) Find $m\angle GRH$

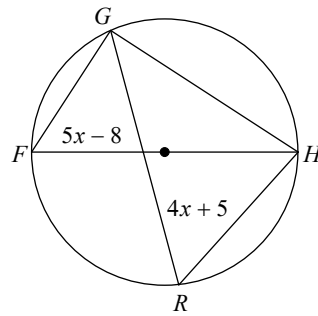

57°

835) Find $m\angle XCD$

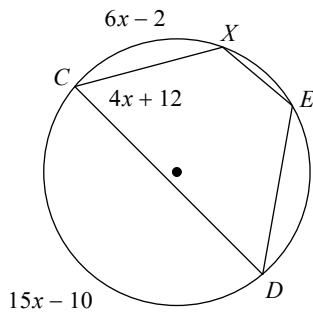

60°

836) Find $m\angle SQR$

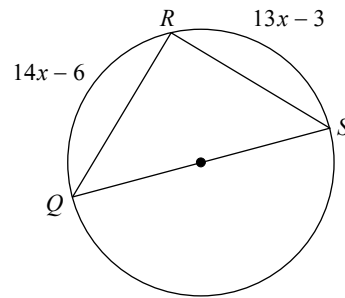

44°

837) Find $m\angle XWY$

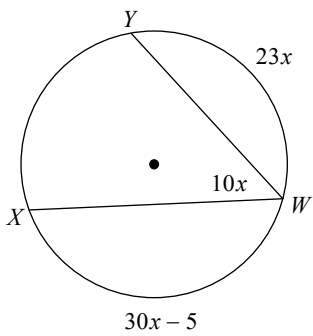

50°

838) Find $m\angle WSR$

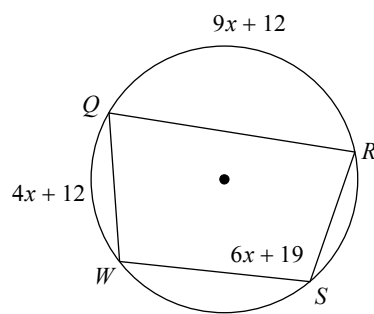

103°

839) Find $m\angle QPR$

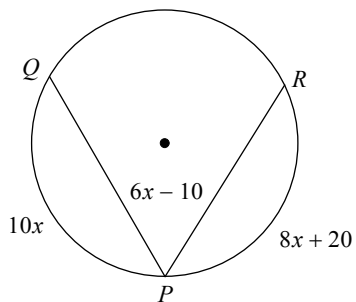

62°

840) Find $m\angle XYW$

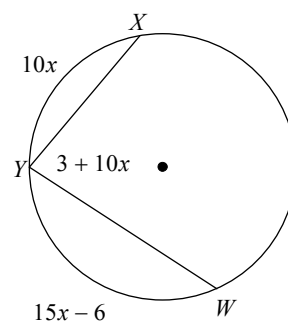

83°

841) Find $m\angle LBJ$

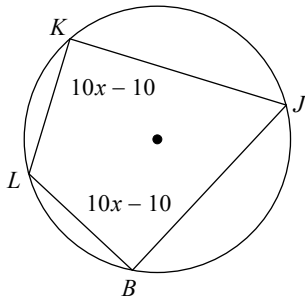

90°

842) Find $m\angle GFH$

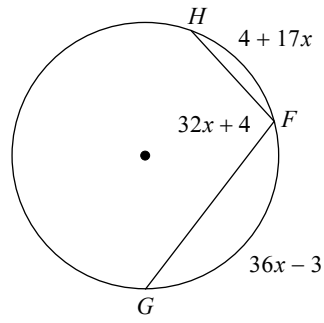

100°

843) Find $m\angle RQS$

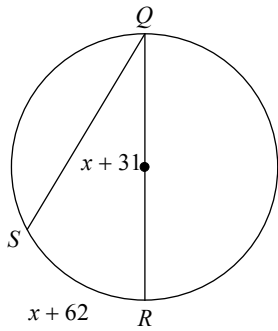

31°

844) Find $m\angle HFG$

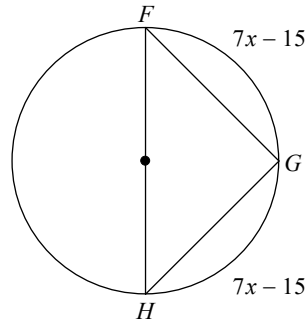

45°

845) Find $m\angle ATS$

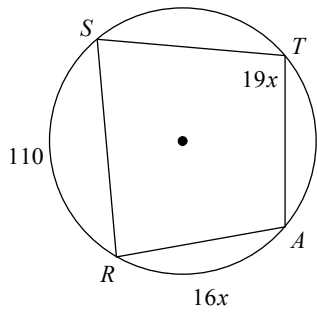

95°

846) Find $m\angle RPQ$

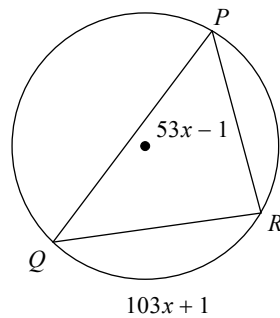

52°

847) Find $m\angle BDC$

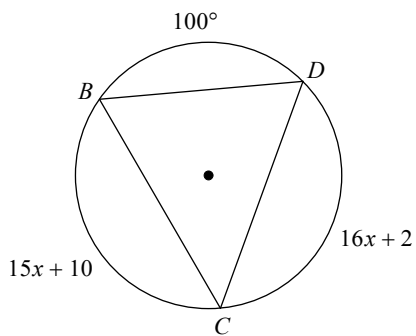

65°

848) Find $m\angle KED$

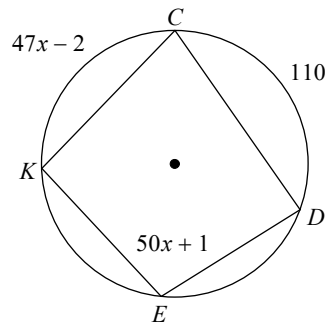

101°

849) Find $m\angle PYX$

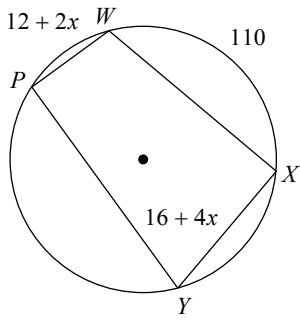

76°

850) Find $m\angle ACB$

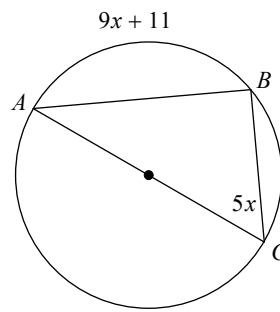

55°

851) Find $m\angle HYX$

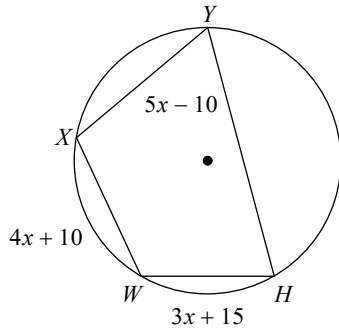

65°

852) Find $m\angle YXZ$

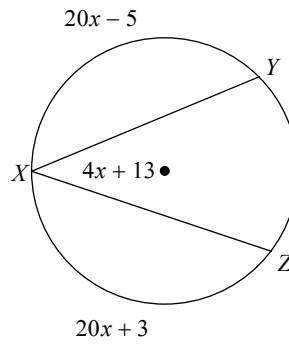

41°

853) Find $m\angle RQS$

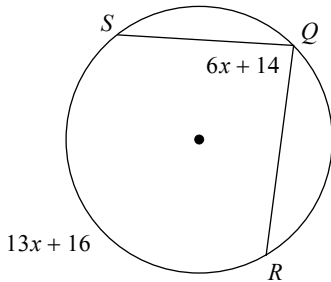

86°

854) Find $m\angle YXZ$

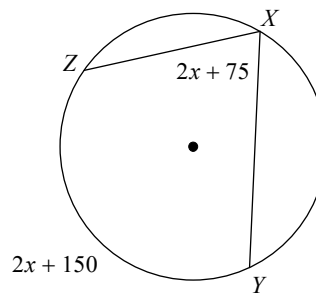

75°

855) Find $m\angle KLJ$

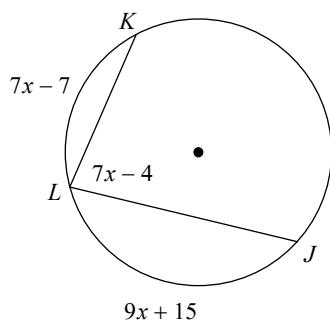

80°

856) Find $m\angle HFG$

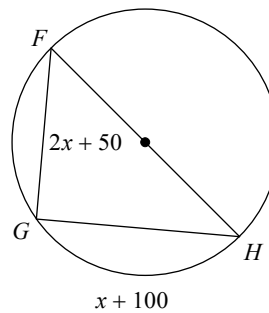

50°

857) Find $m\angle FWX$

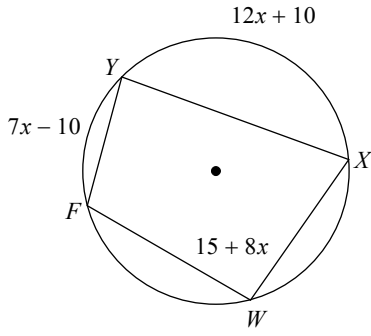

95°

858) Find $m\angle TRS$

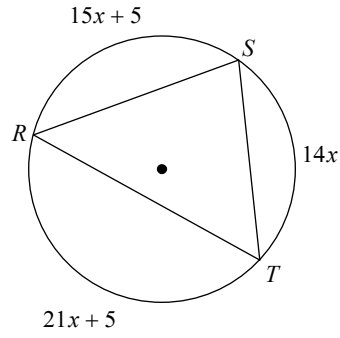

49°

859) Find $m\angle EDF$

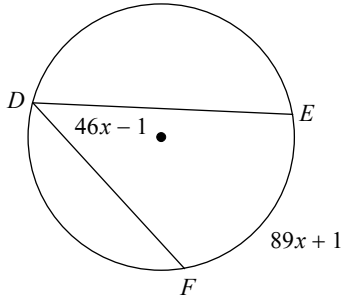

45°

860) Find $m\angle YWX$

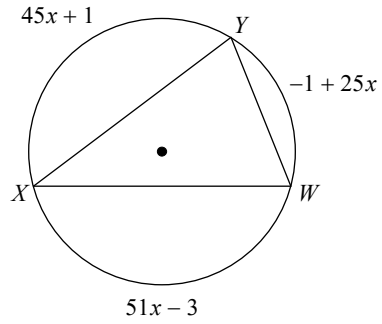

68°

861) Find $m\angle FHG$

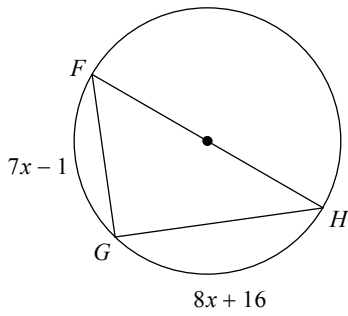

38°

862) Find $m\angle LKM$

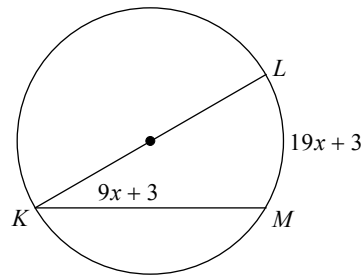

30°

863) Find $m\angle BGD$

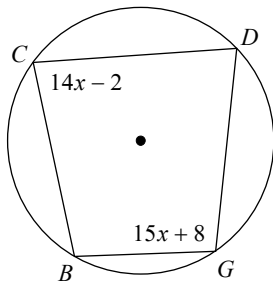

98°

864) Find $m\angle RTS$

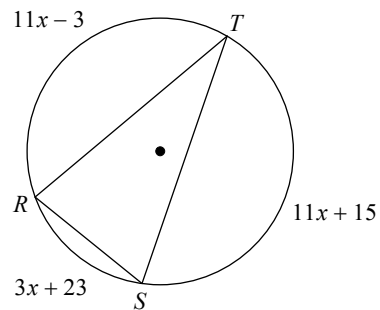

31°

865) Find $m\angle RDS$

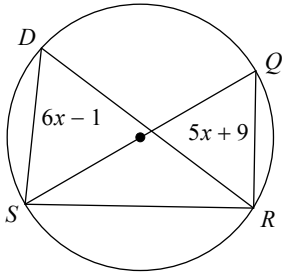

59°

866) Find $m\angle CAB$

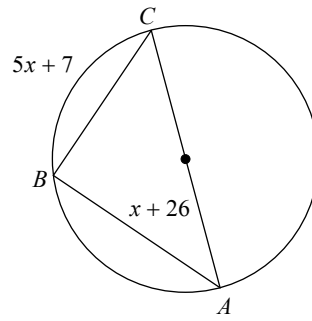

41°

Find the angle measure by solving the system of equations

867)

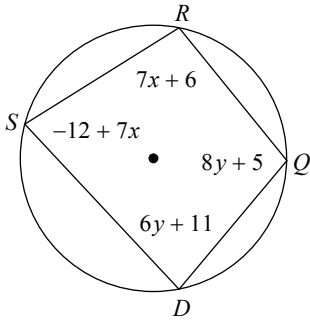

$x = 13, y = 12$

868)

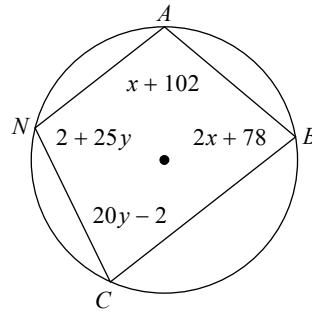

$x = 0, y = 4$

869)

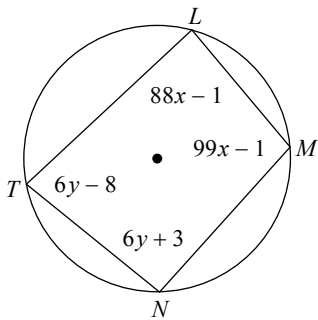

$x = 1, y = 15$

870)

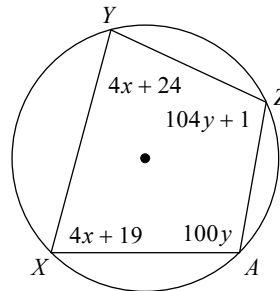

$x = 14, y = 1$

871)

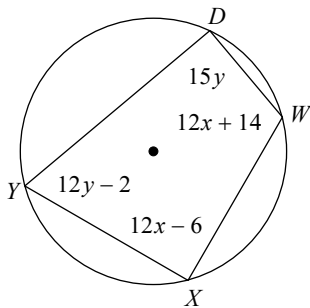

$x = 8, y = 6$

872)

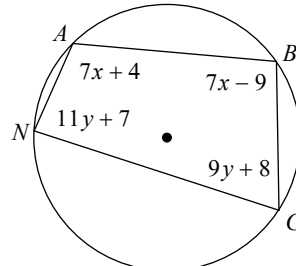

$x = 15, y = 7$

873)

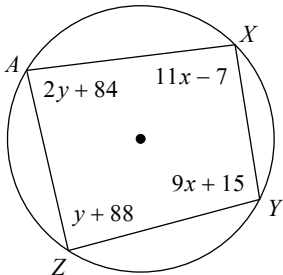

$x = 9, y = 0$

874)

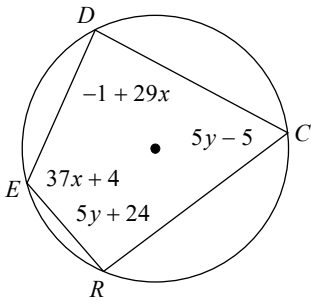

$$x = 3, y = 14$$

875)

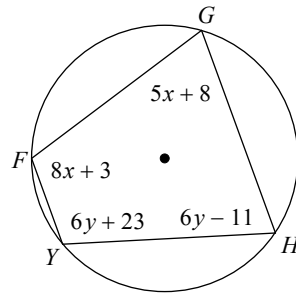

$$x = 13, y = 14$$

876)

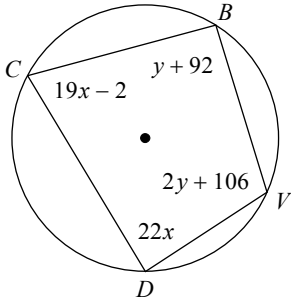

$$x = 4, y = 0$$

877)

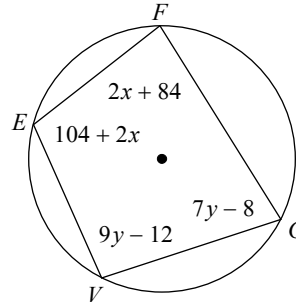

$$x = 0, y = 12$$

878)

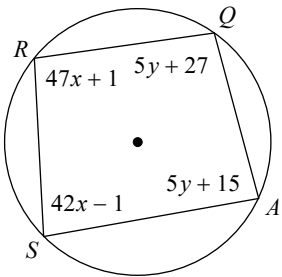

$$x = 2, y = 14$$

879)

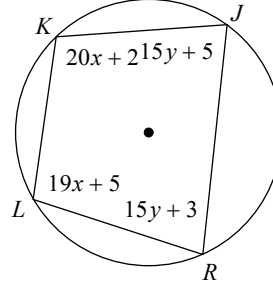

$$x = 5, y = 5$$

880)

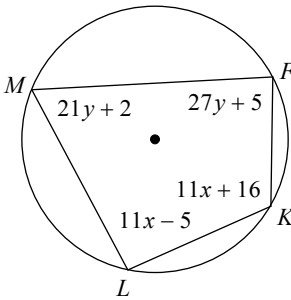

$$x = 9, y = 3$$

881)

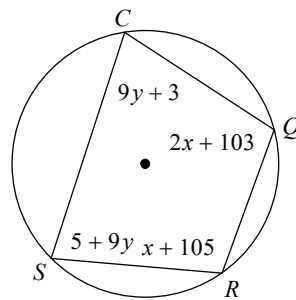

$$x = 0, y = 8$$

882)

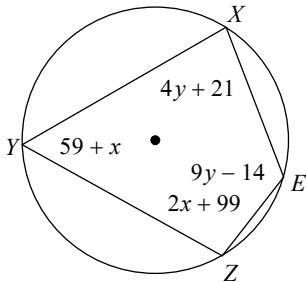

$$x = 0, y = 15$$

883)

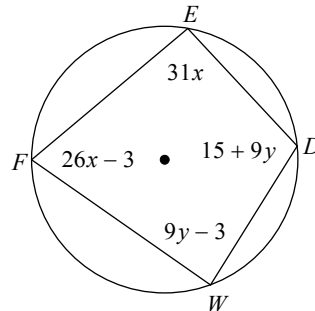

$$x = 3, y = 10$$

884)

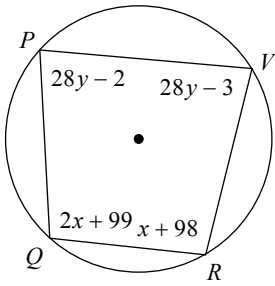

$$x = 0, y = 3$$

885)

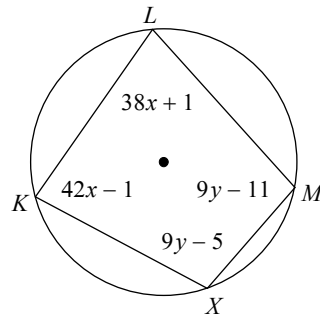

$$x = 2, y = 12$$

886)

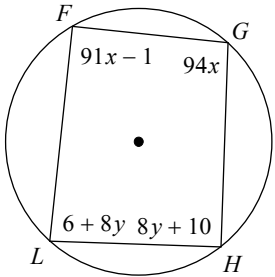

$$x = 1, y = 10$$

887)

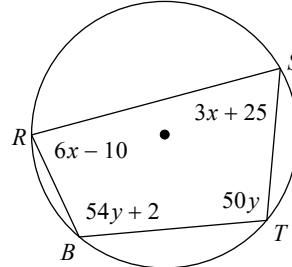

$$x = 15, y = 2$$

888)

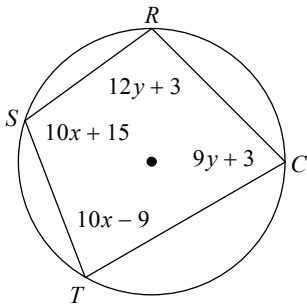

$$x = 9, y = 8$$

889)

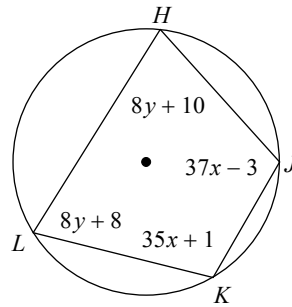

$$x = 3, y = 8$$

890)

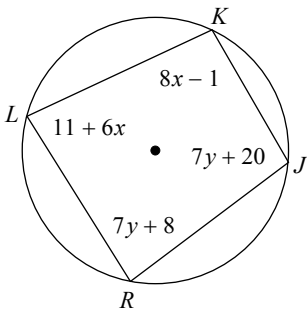

$$x = 12, y = 11$$

891)

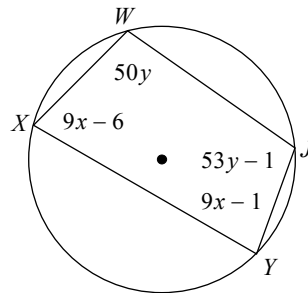

$$x = 9, y = 2$$

892)

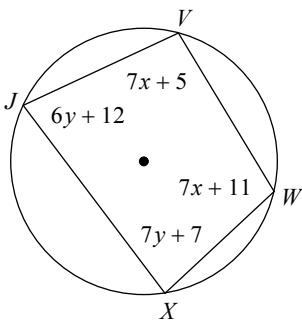

$$x = 13, y = 11$$

893)

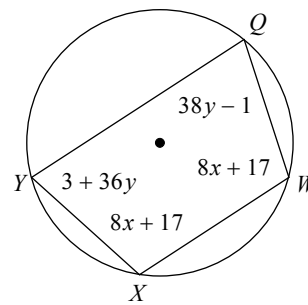

$$x = 11, y = 2$$

894)

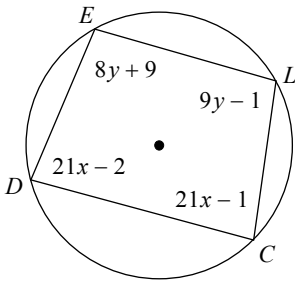

$$x = 4, y = 11$$

895)

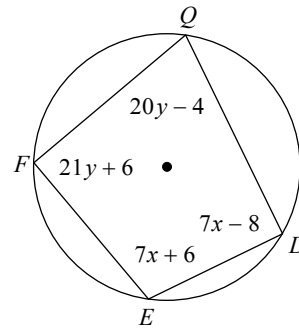

$$x = 14, y = 4$$

896)

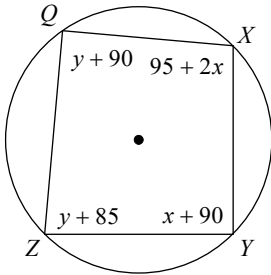

$$x = 0, y = 0$$

897)

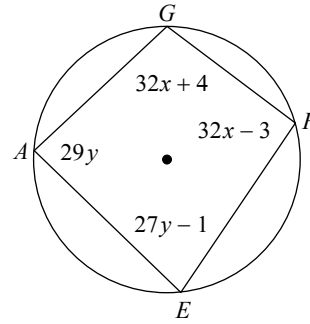

$$x = 3, y = 3$$

898)

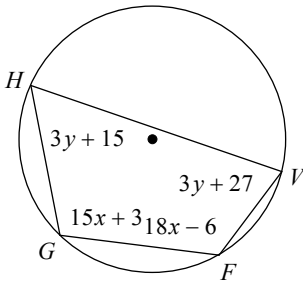

$$x = 7, y = 15$$

899)

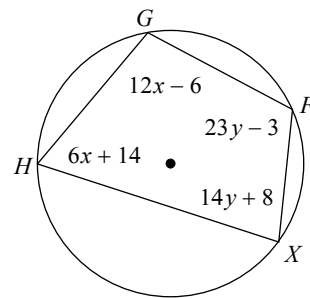

$$x = 9, y = 5$$

900)

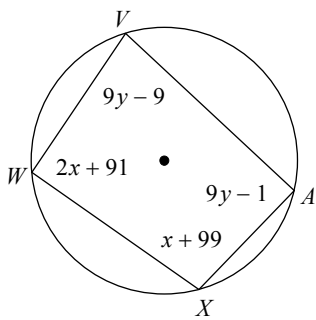

$$x = 0, y = 10$$

901)

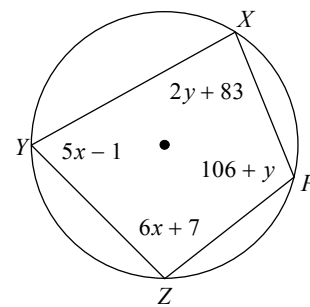

$$x = 15, y = 0$$

902)

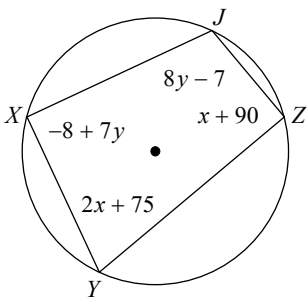

$$x = 0, y = 14$$

903)

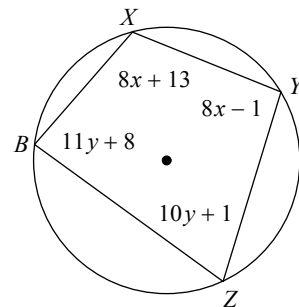

$$x = 12, y = 7$$

904)

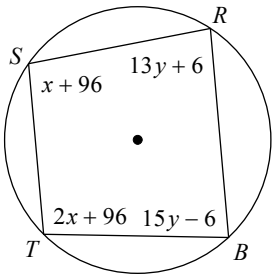

$x = 0, y = 6$

905)

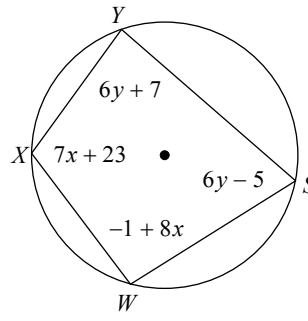

$x = 12, y = 13$

906)

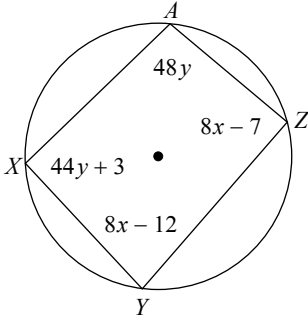

$x = 12, y = 2$

907)

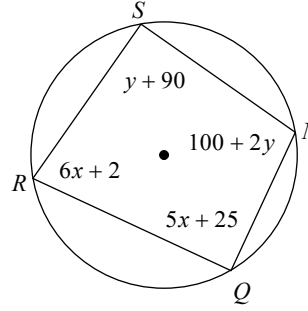

$x = 13, y = 0$

908)

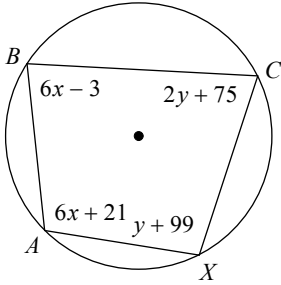

$x = 14, y = 0$

909)

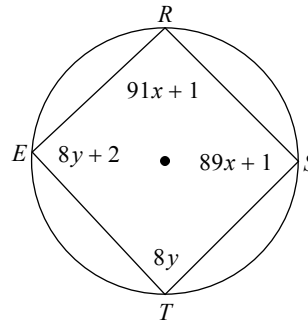

$x = 1, y = 11$

910)

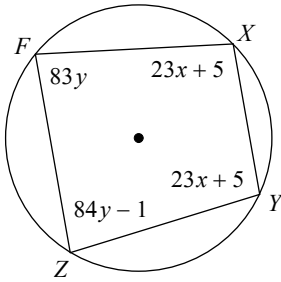

$x = 4, y = 1$

911)

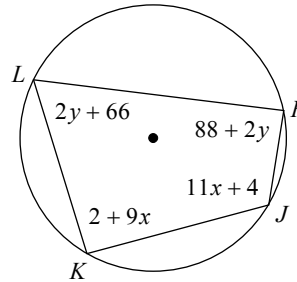

$x = 10, y = 0$

912)

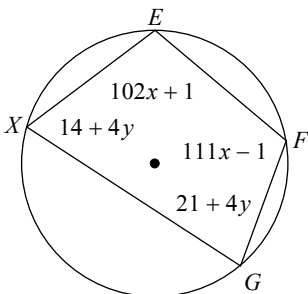

$x = 1, y = 14$