

Draw a solid from drawn net

Draw a solid from given net of each prism:

1)

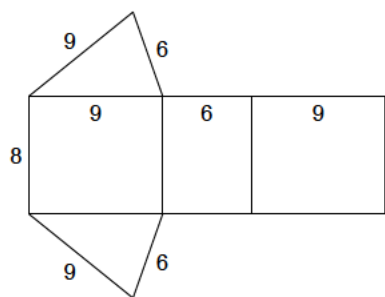

2)

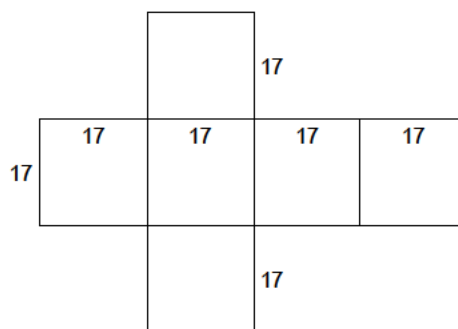

3)

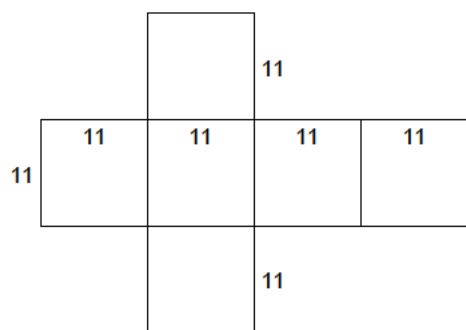

4)

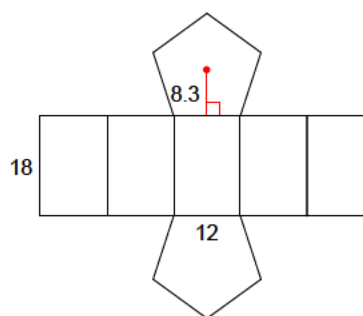

5)

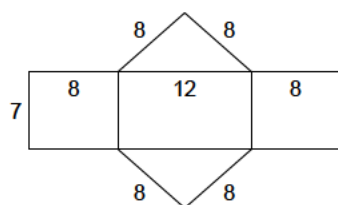

6)

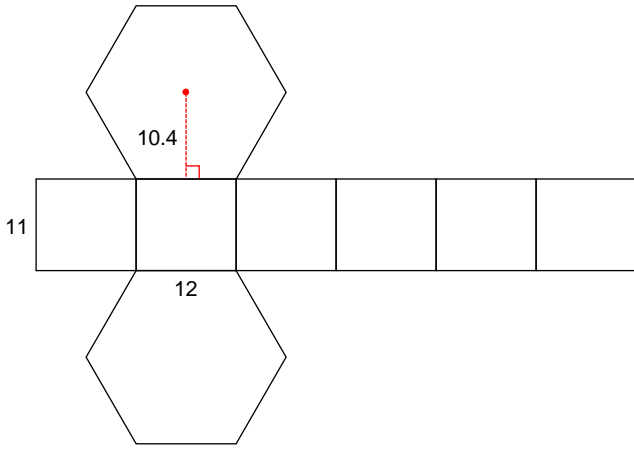

7)

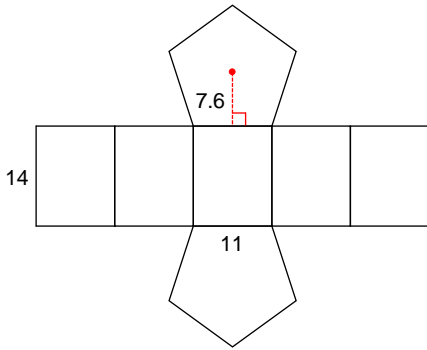

8)

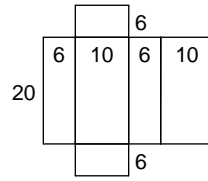

9)

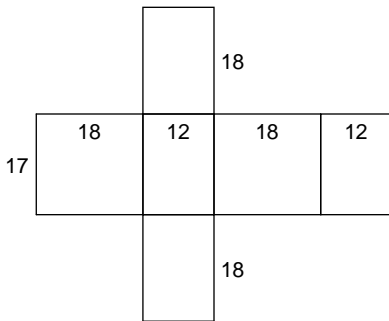

10)

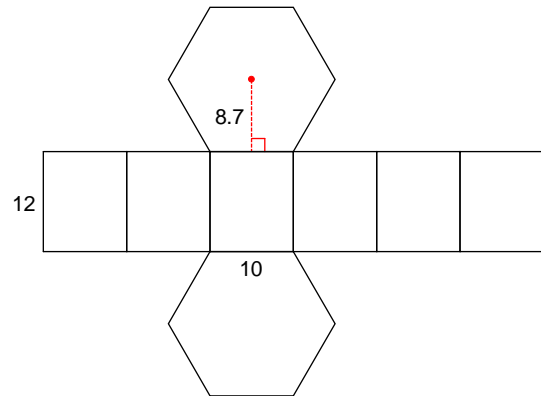

11)

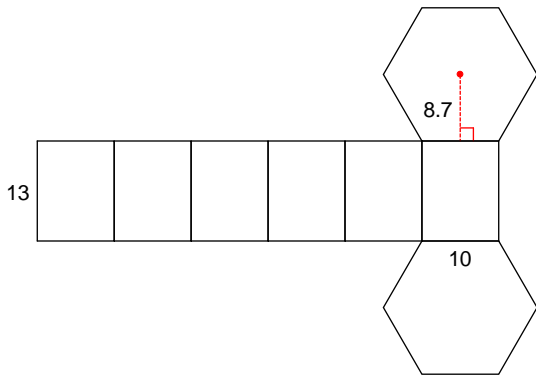

12)

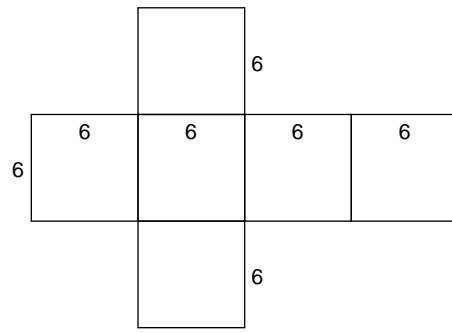

13)

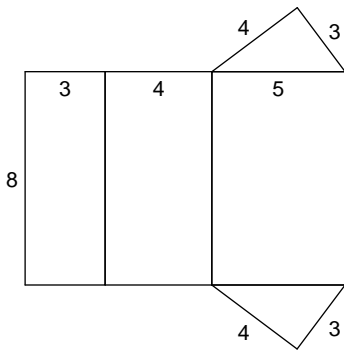

14)

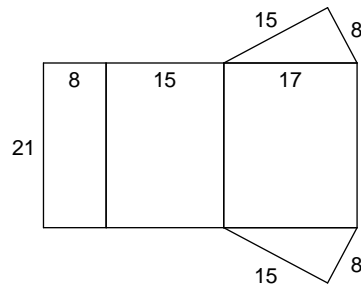

15)

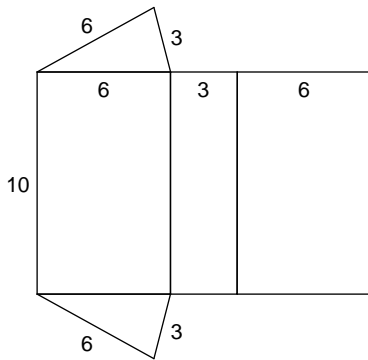

16)

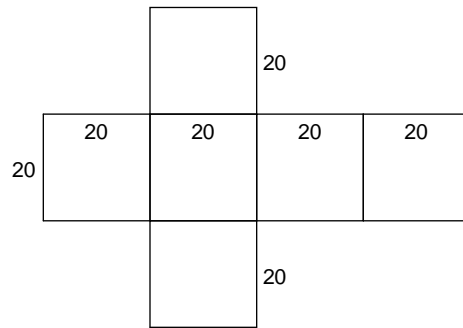

17)

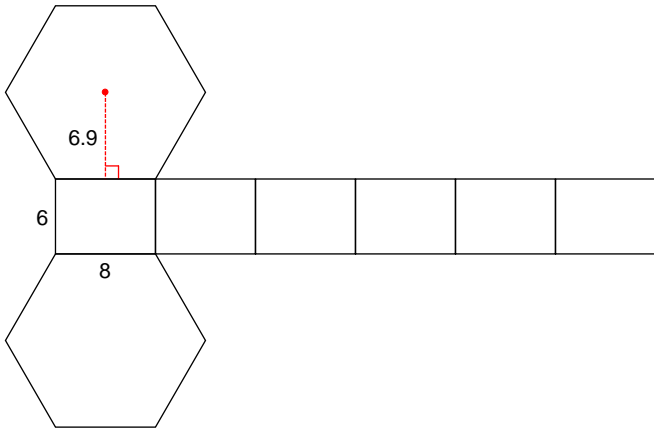

18)

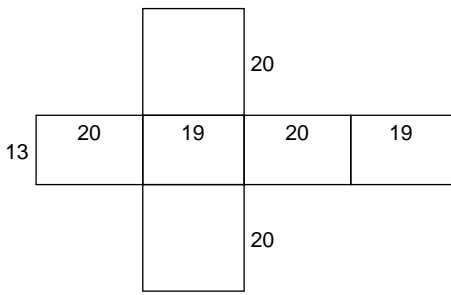

19)

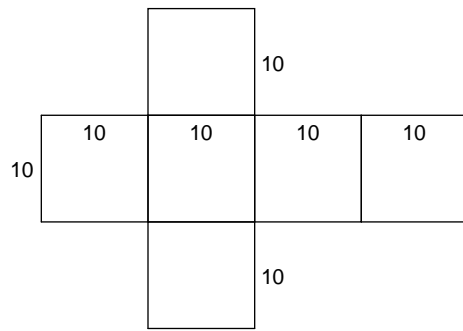

20)

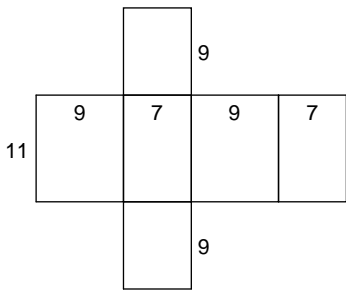

21)

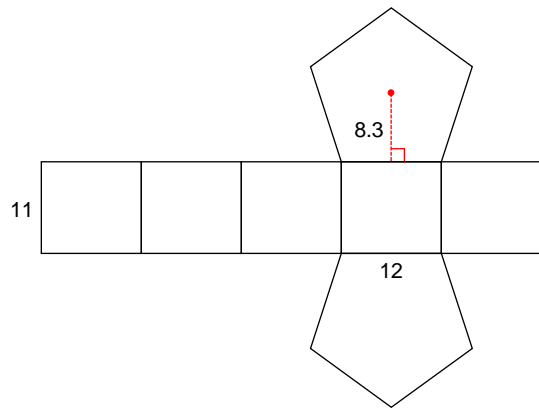

22)

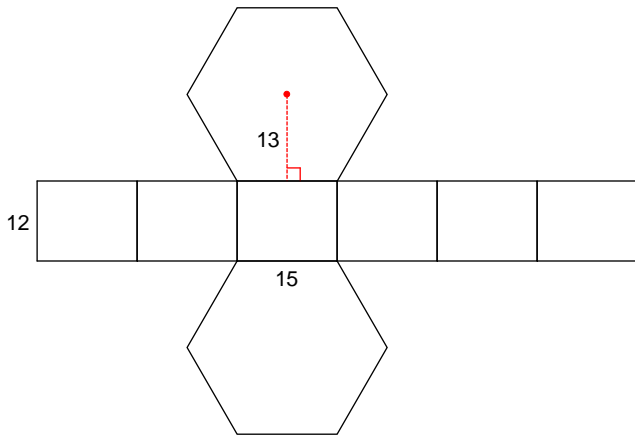

23)

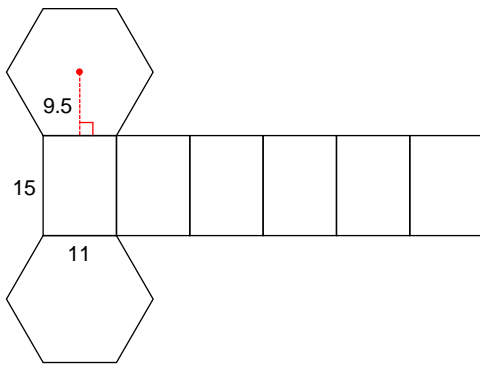

24)

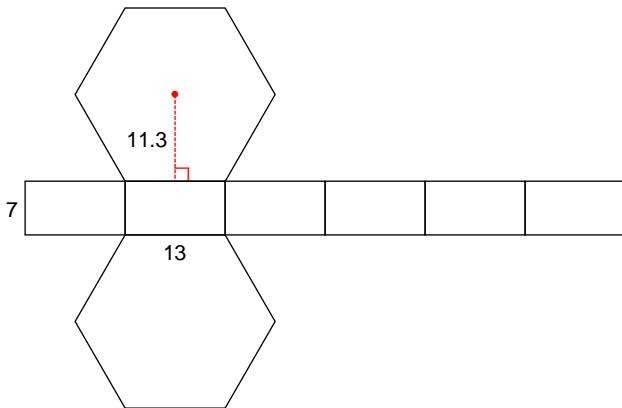

25)

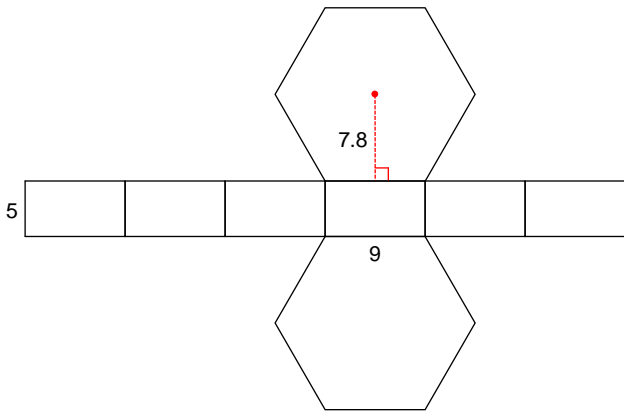

26)

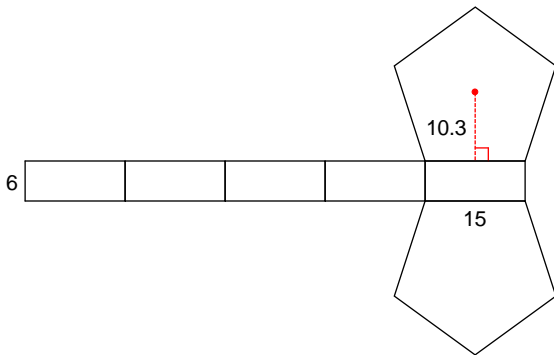

27)

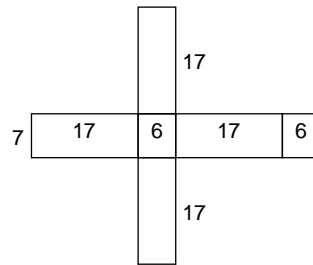

28)

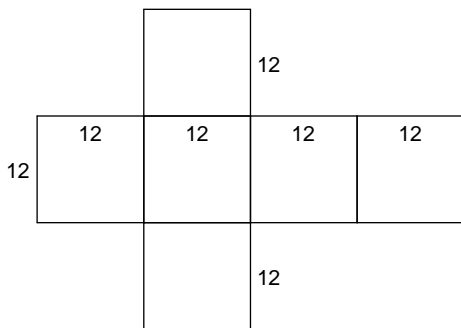

29)

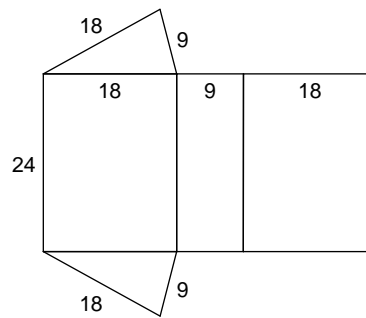

30)

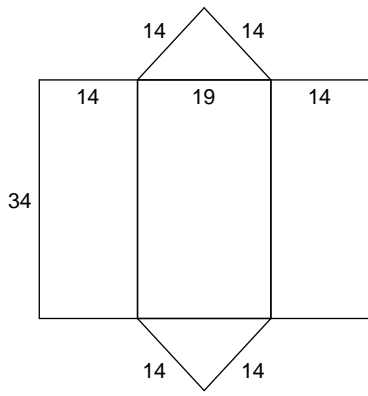

31)

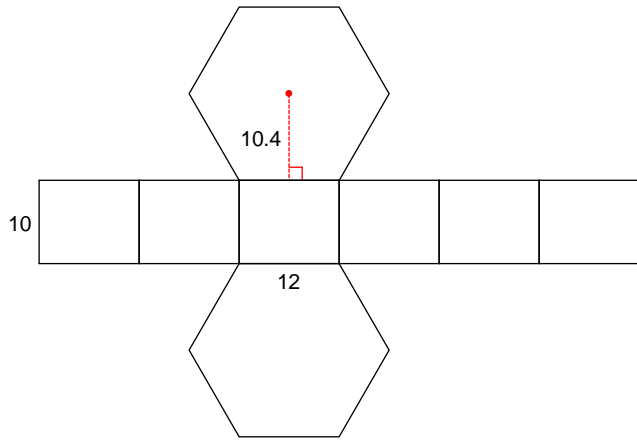

32)

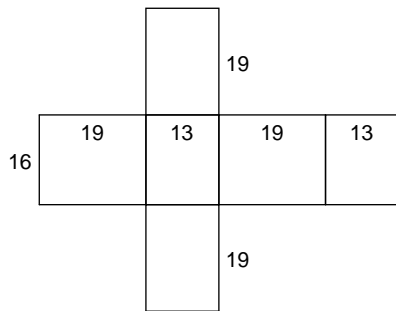

33)

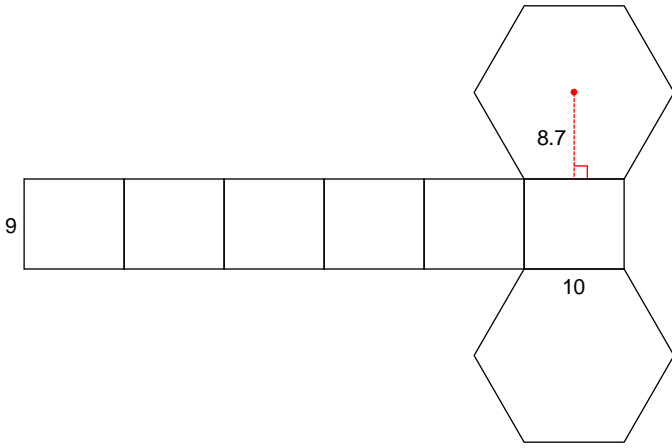

34)

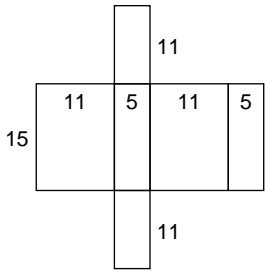

35)

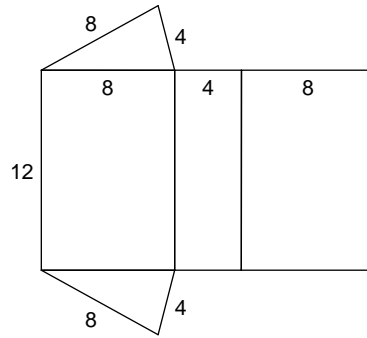

36)

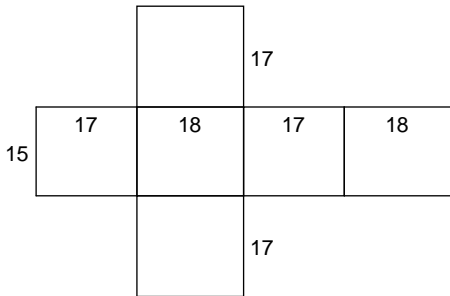

37)

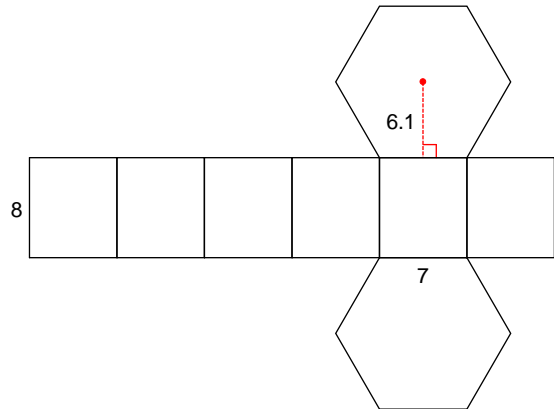

38)

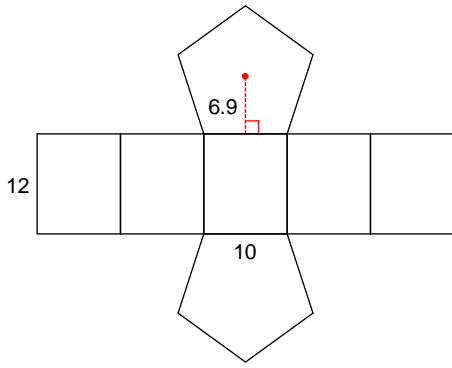

39)

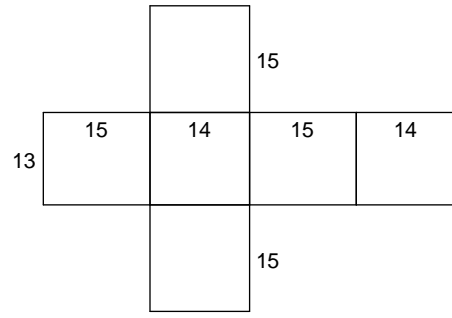

40)

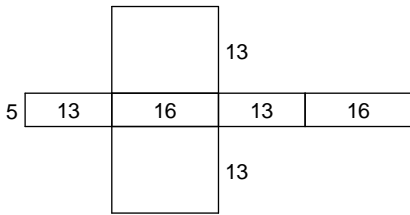

41)

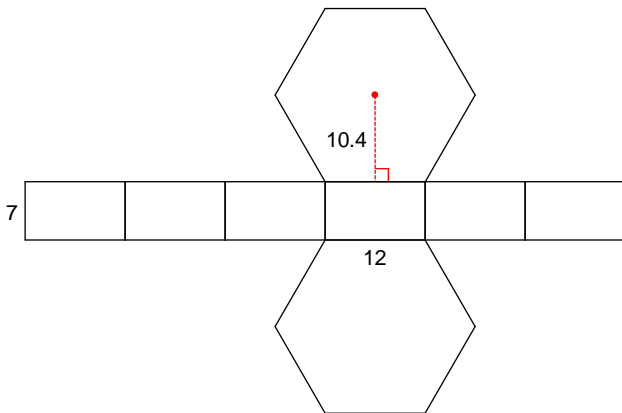

42)

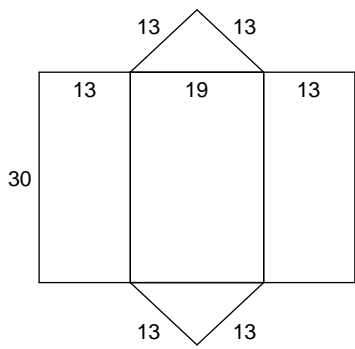

43)

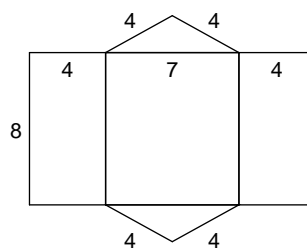

44)

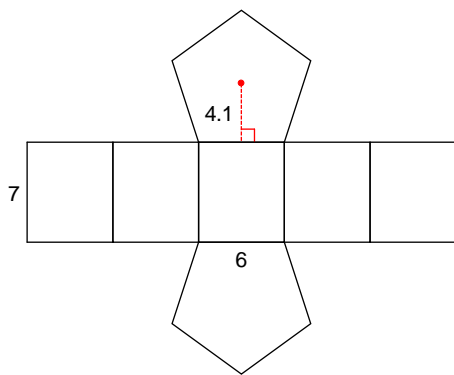

45)

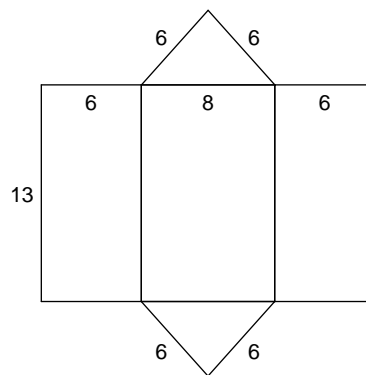

46)

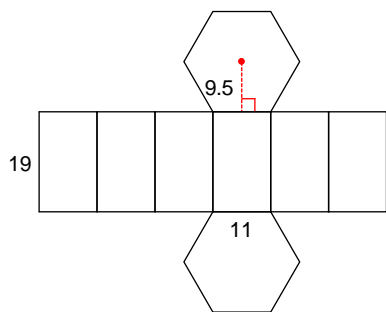

47)

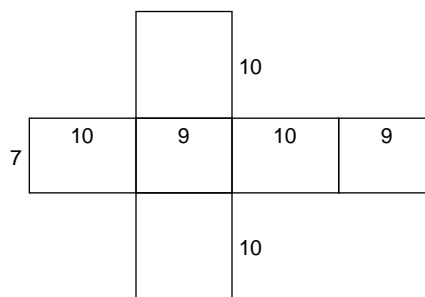

48)

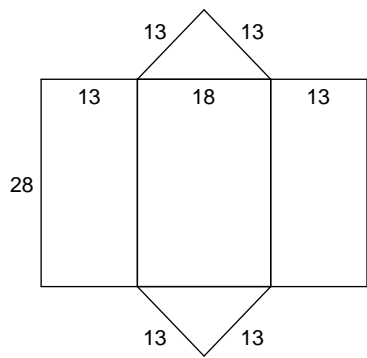

49)

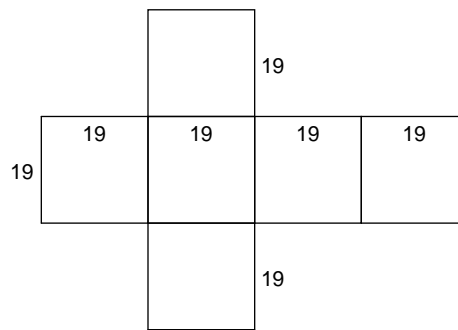

50)

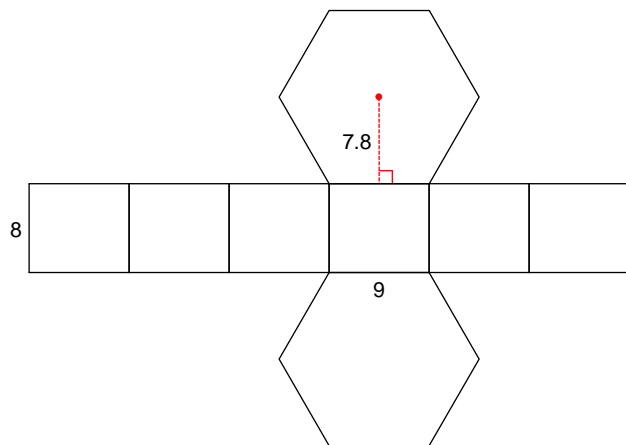

51)

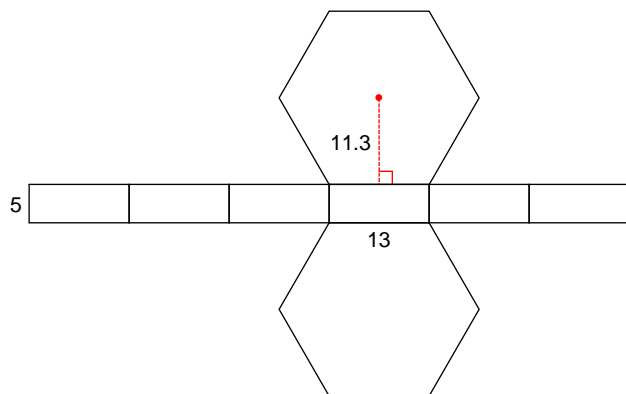

52)

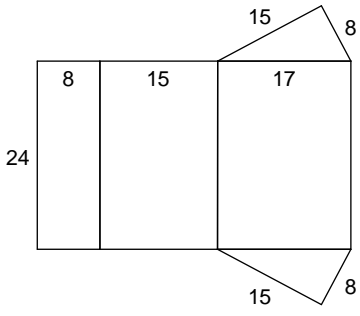

53)

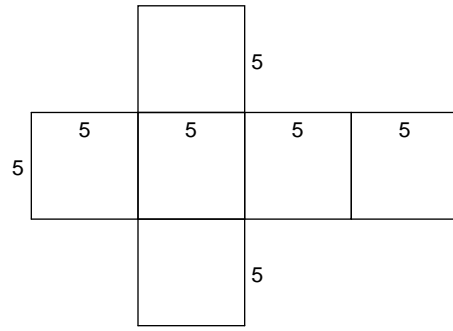

54)

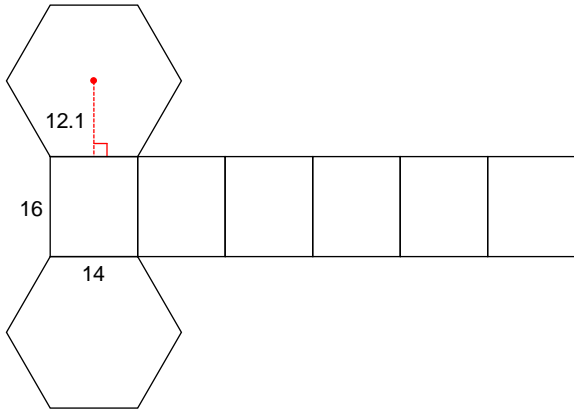

55)

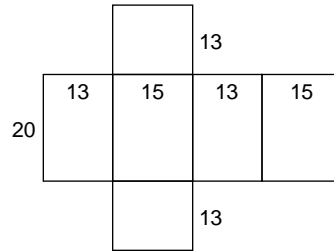

56)

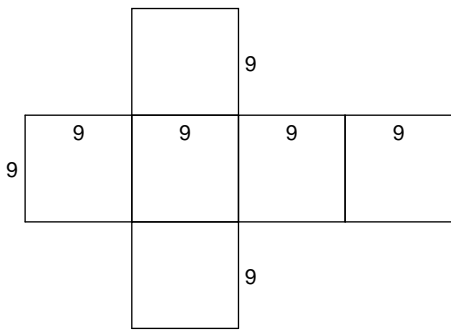

57)

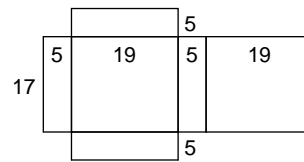

58)

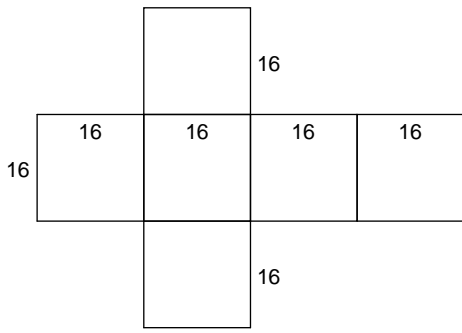

59)

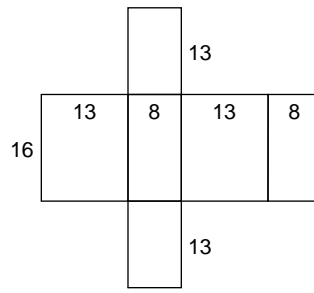

60)

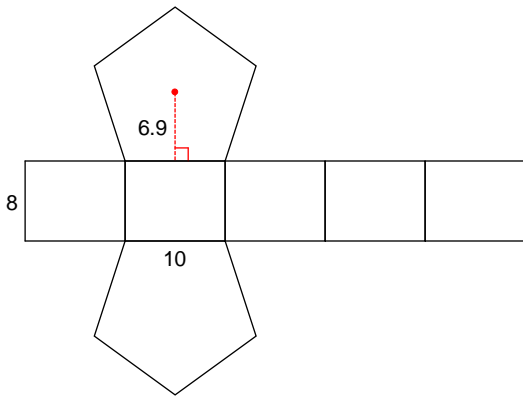

61)

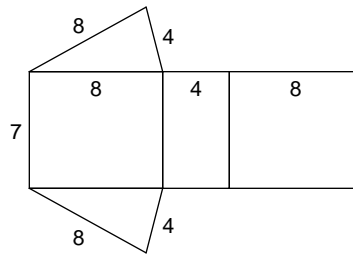

62)

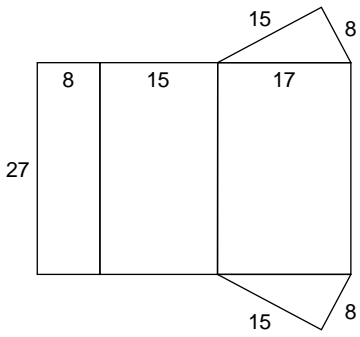

63)

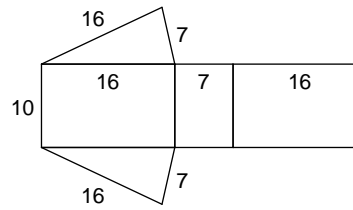

64)

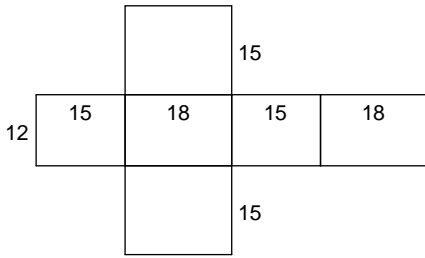

65)

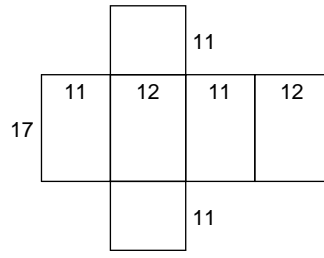

66)

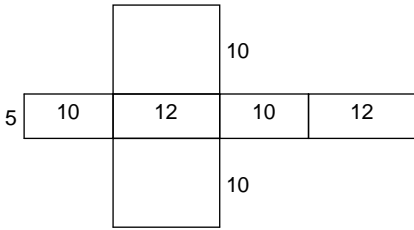

67)

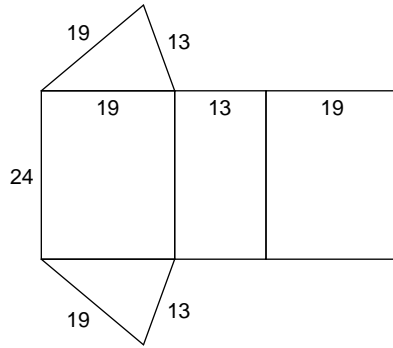

68)

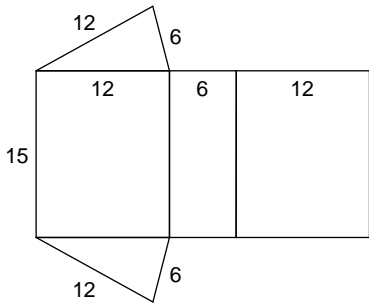

69)

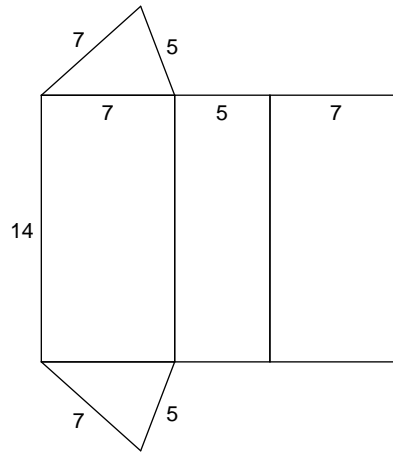

70)

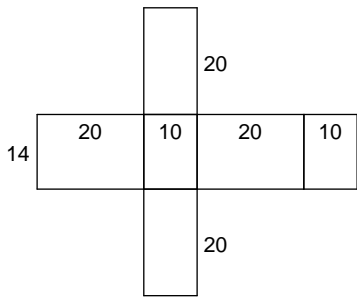

71)

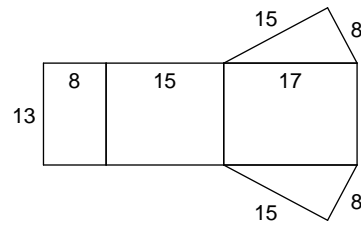

72)

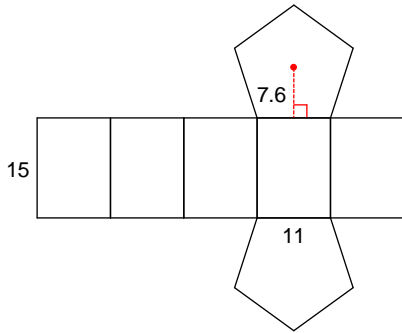

73)

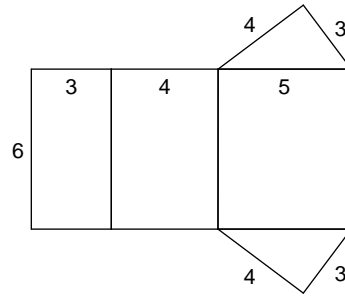

74)

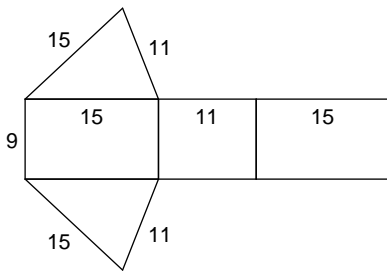

75)

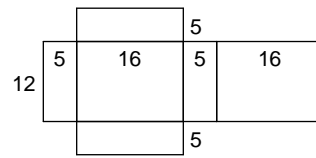

76)

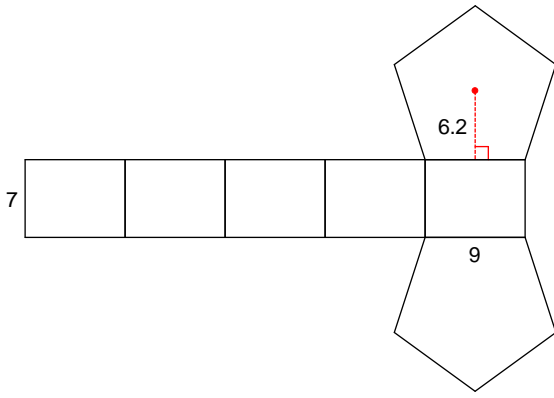

77)

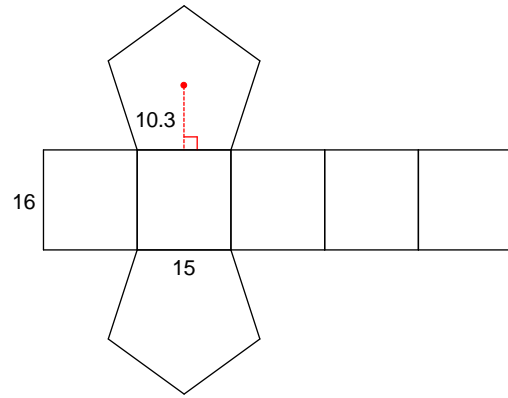

78)

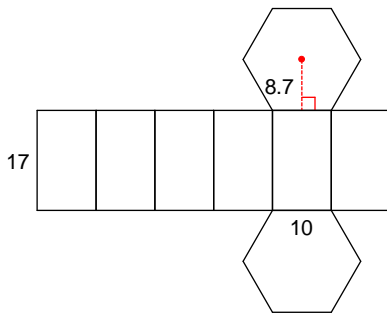

79)

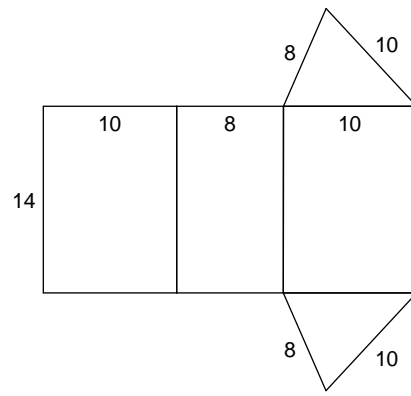

80)

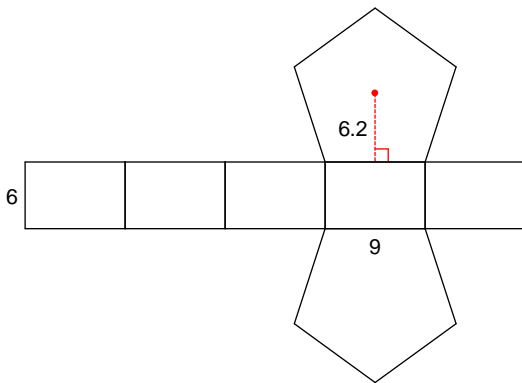

81)

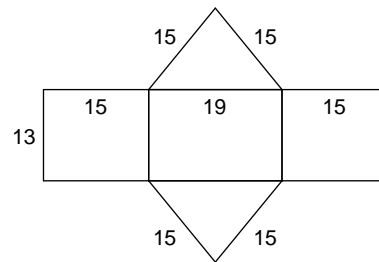

82)

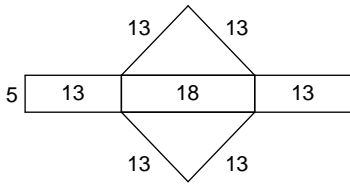

83)

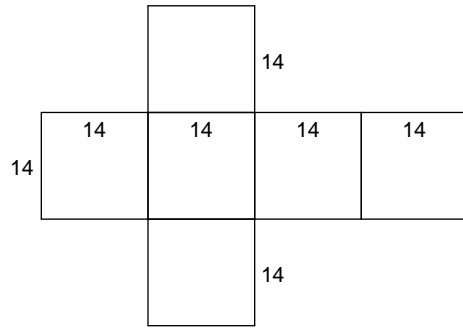

84)

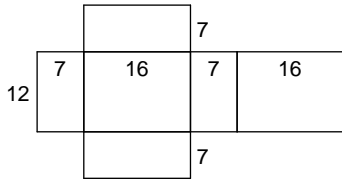

85)

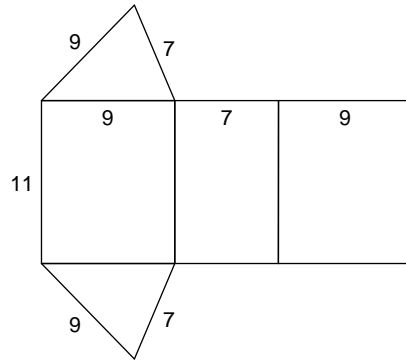

86)

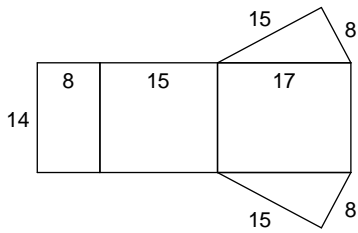

87)

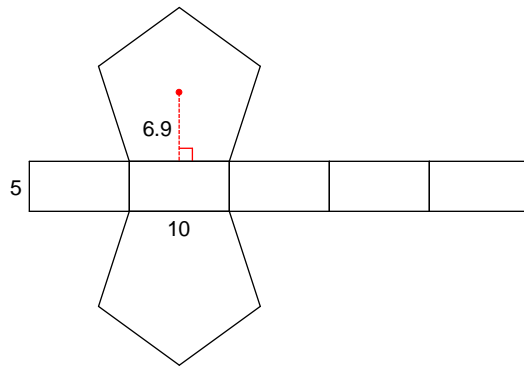

88)

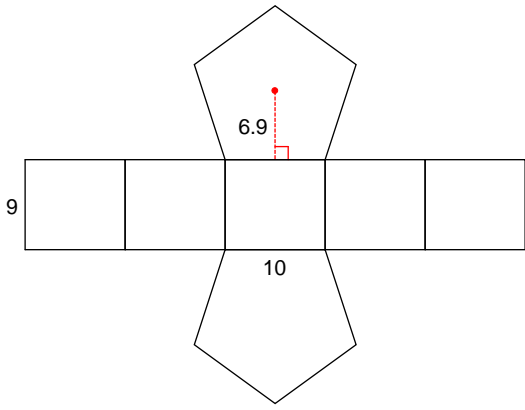

89)

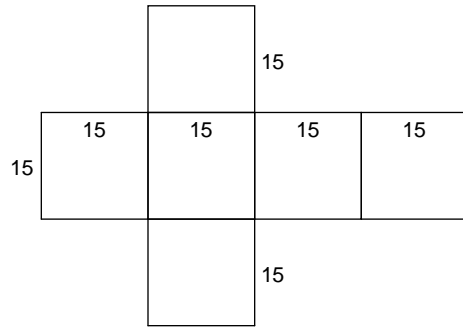

90)

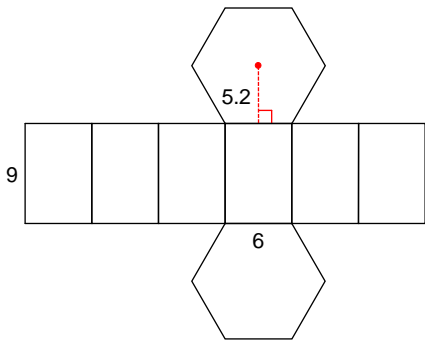

91)

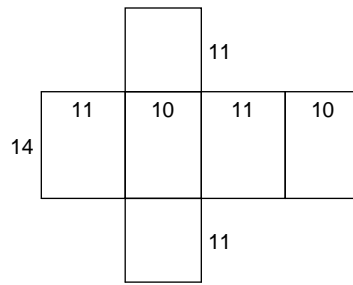

92)

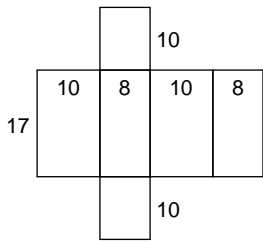

93)

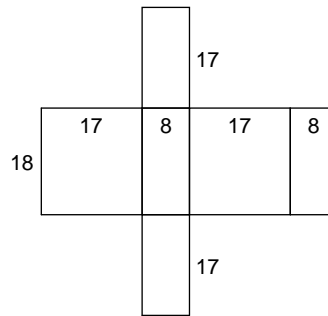

94)

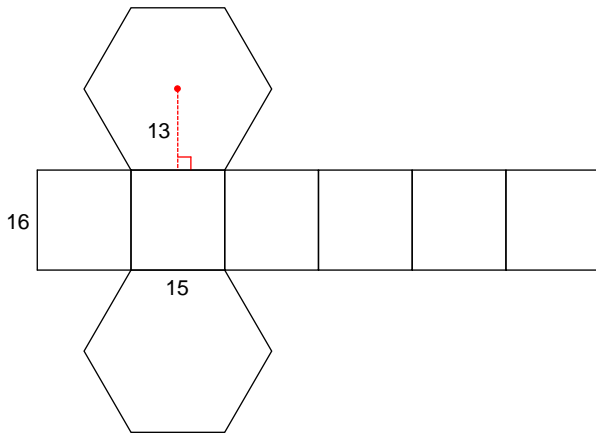

95)

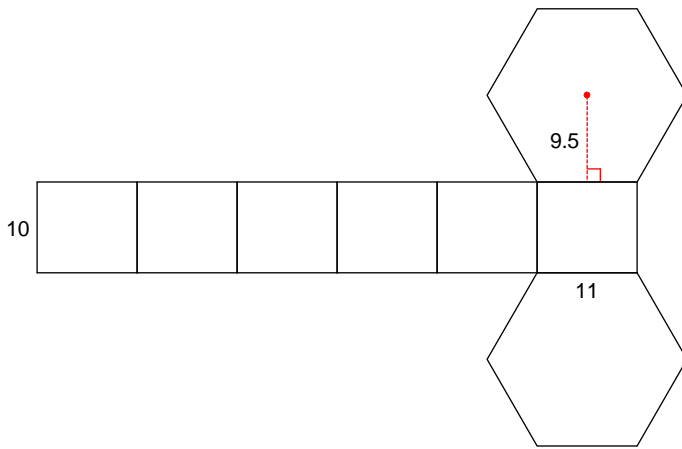

96)

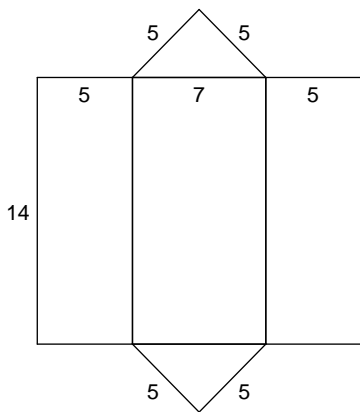

97)

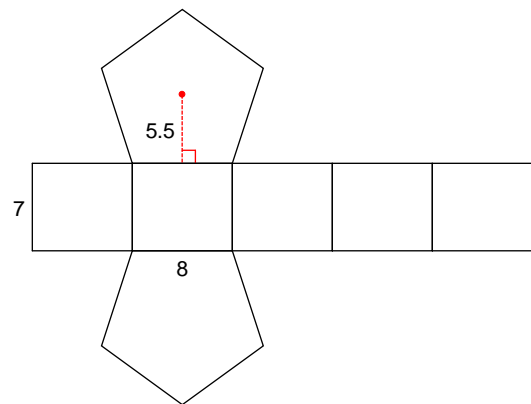

98)

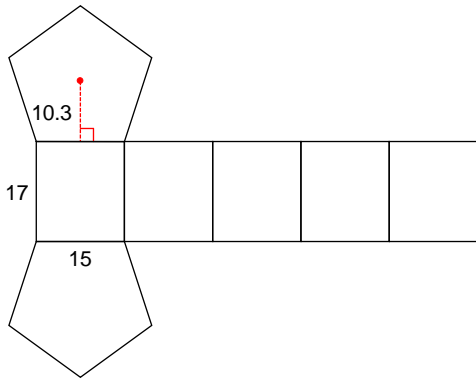

99)

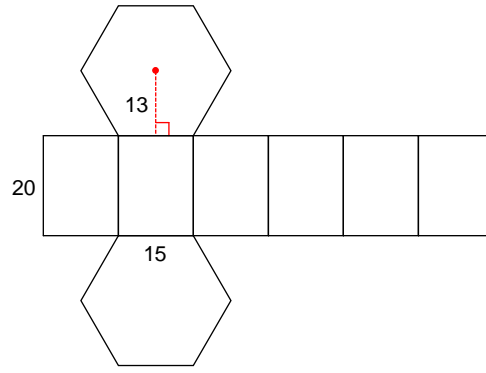

100)

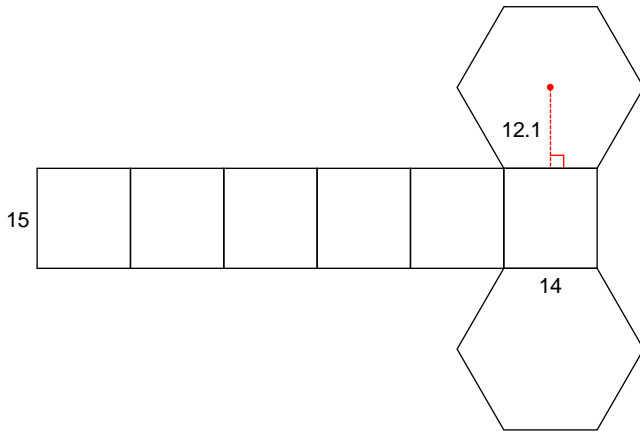

Draw a solid from given net of each pyramid:

101)

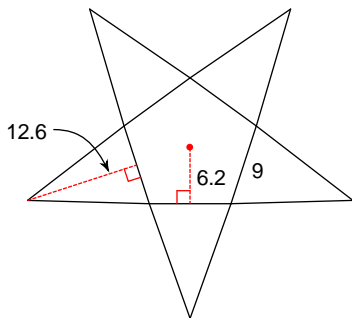

102)

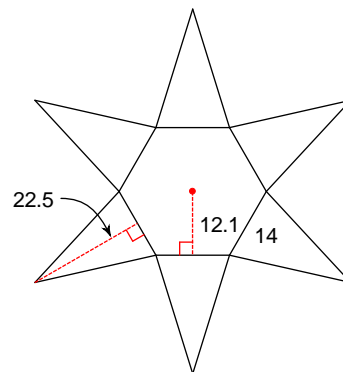

103)

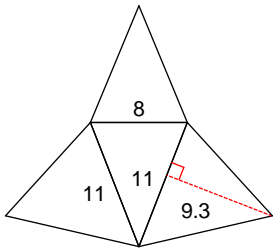

104)

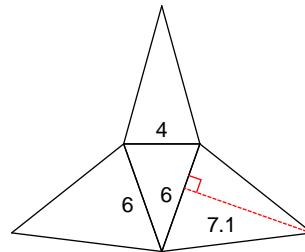

105)

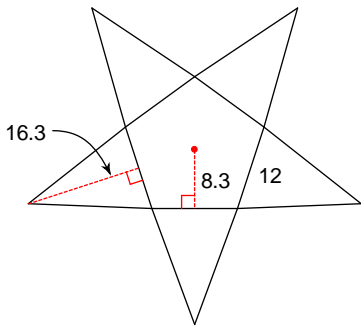

106)

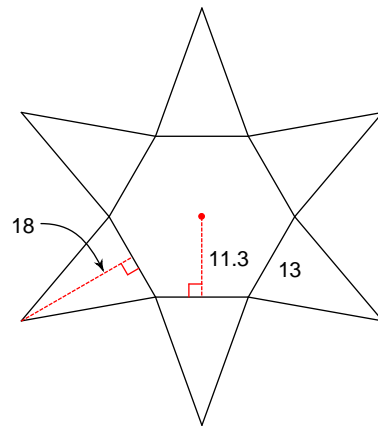

107)

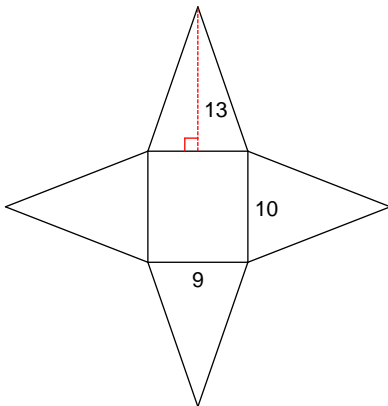

108)

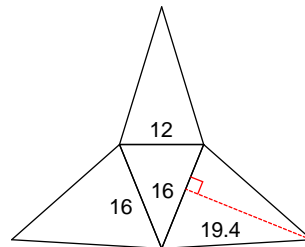

109)

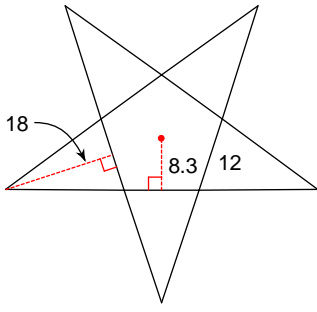

110)

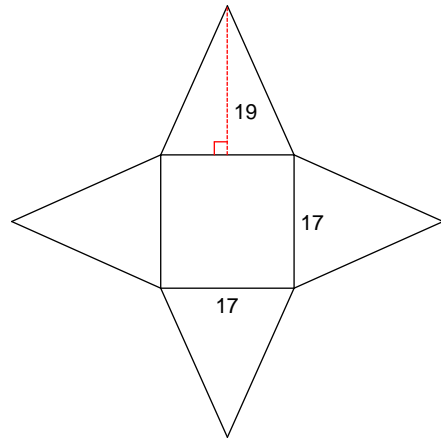

111)

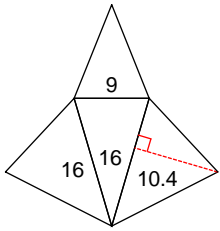

112)

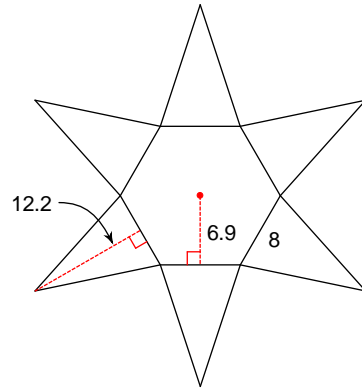

113)

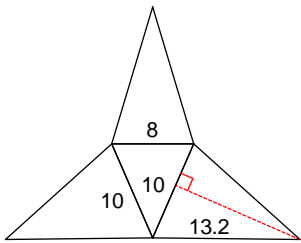

114)

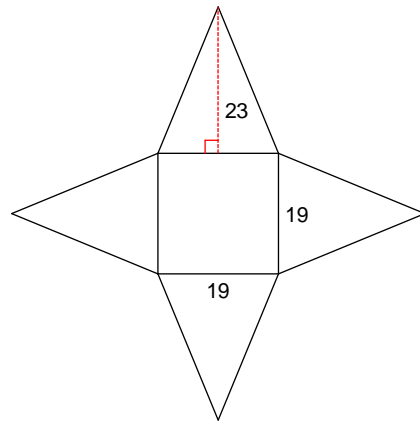

115)

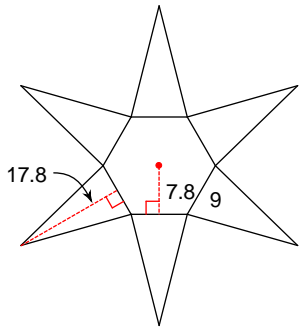

116)

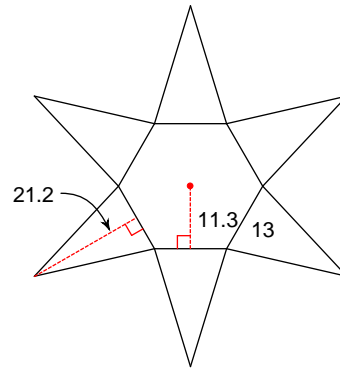

117)

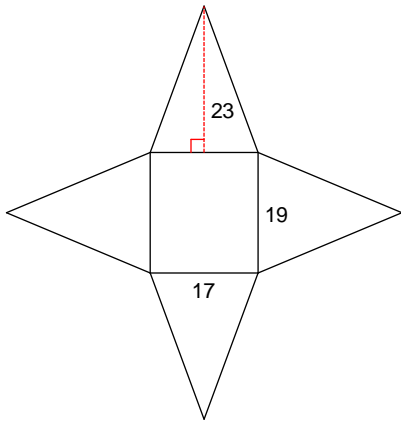

118)

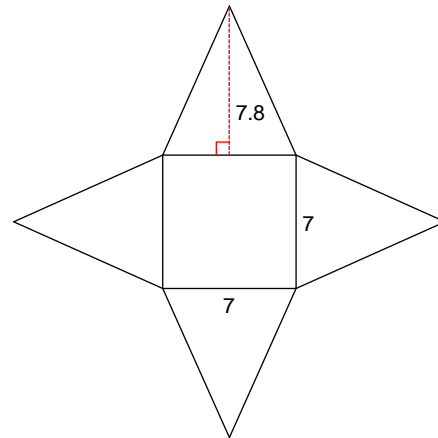

119)

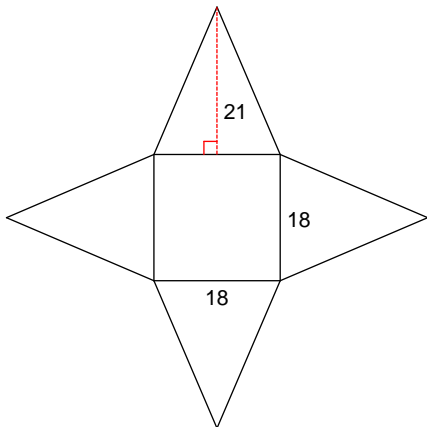

120)

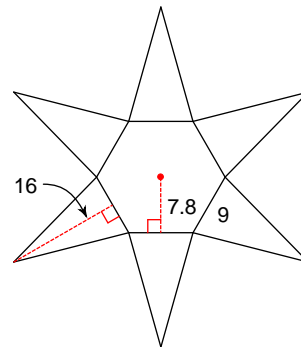

121)

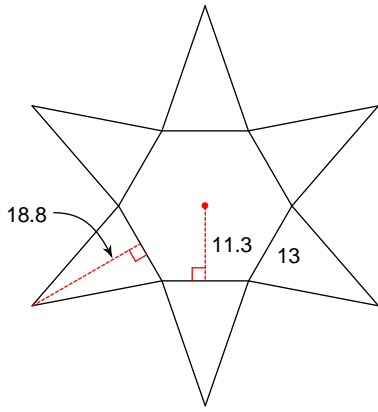

122)

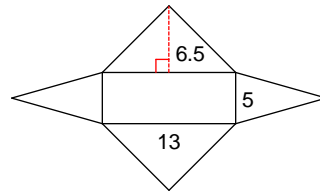

123)

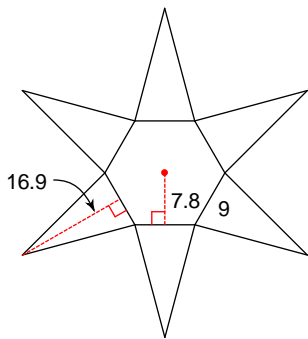

124)

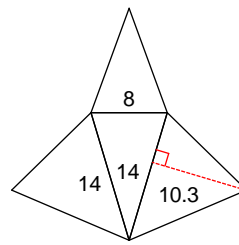

125)

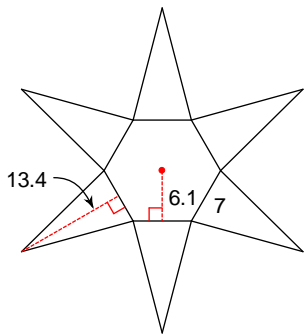

126)

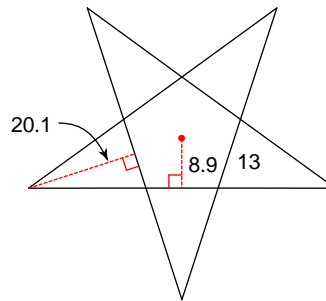

127)

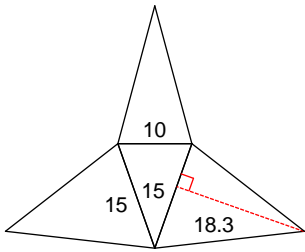

128)

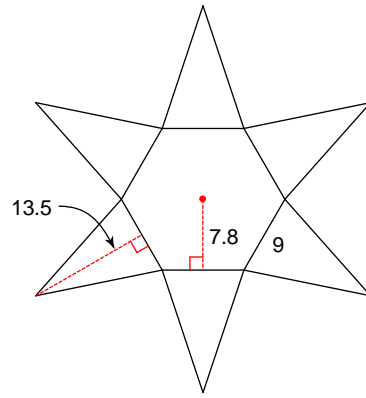

129)

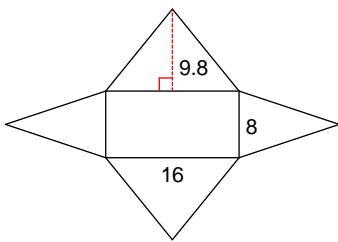

130)

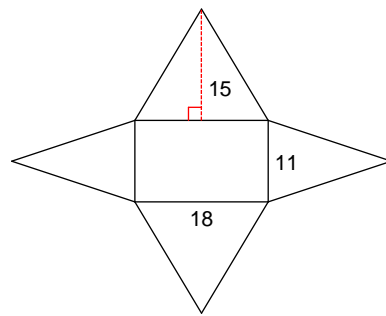

131)

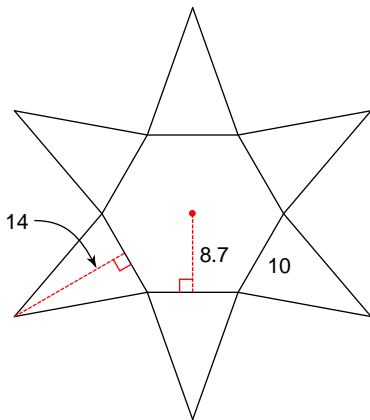

132)

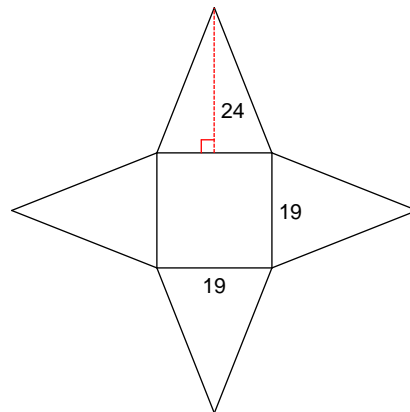

133)

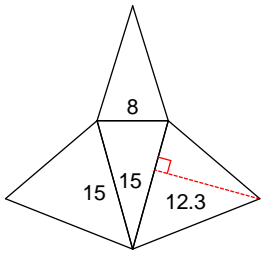

134)

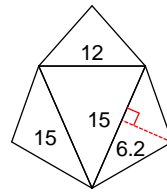

135)

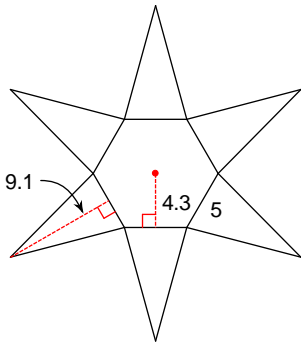

136)

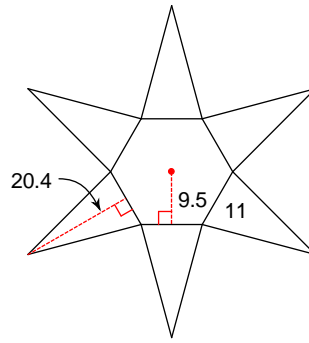

137)

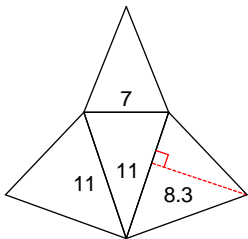

138)

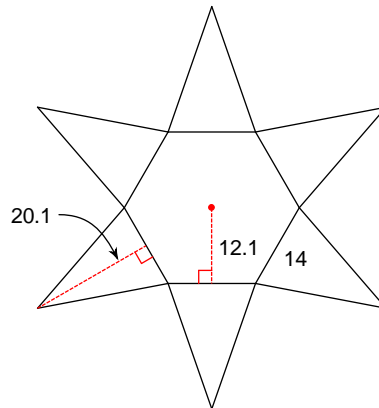

139)

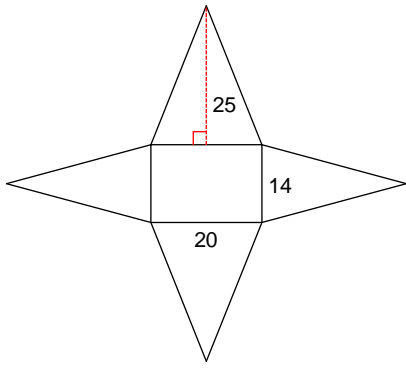

140)

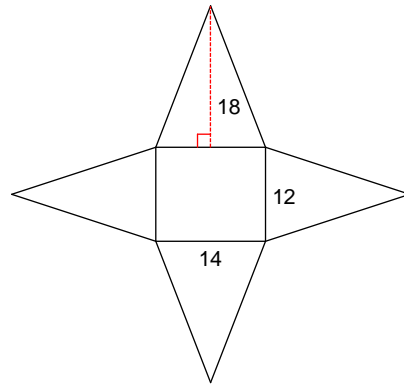

141)

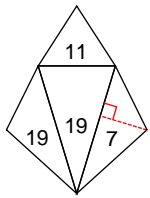

142)

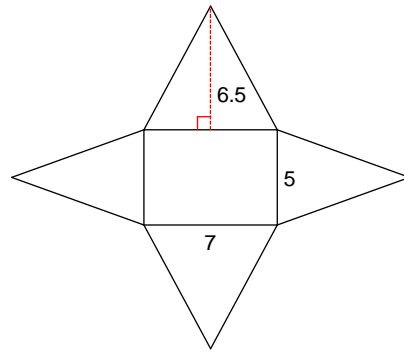

143)

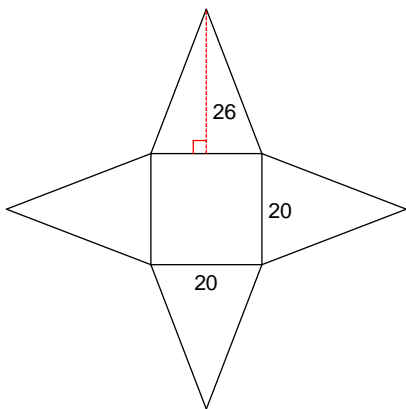

144)

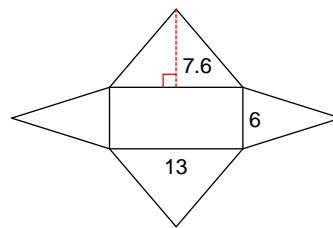

145)

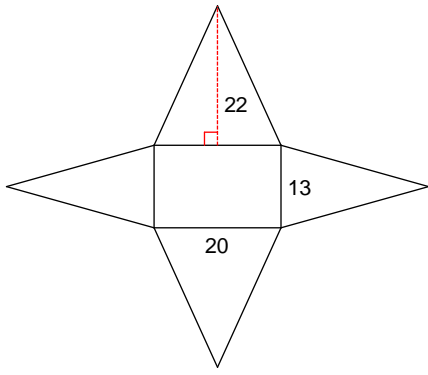

146)

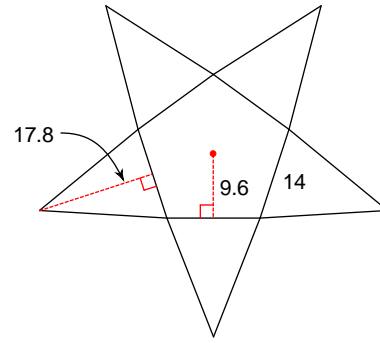

147)

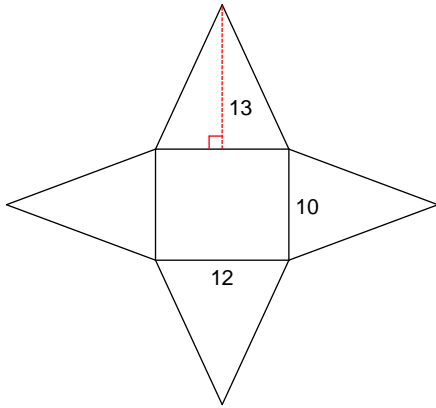

148)

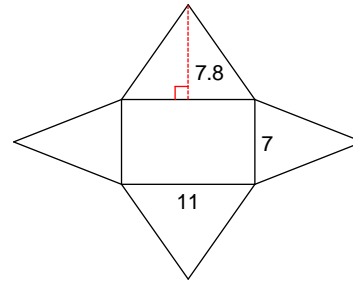

149)

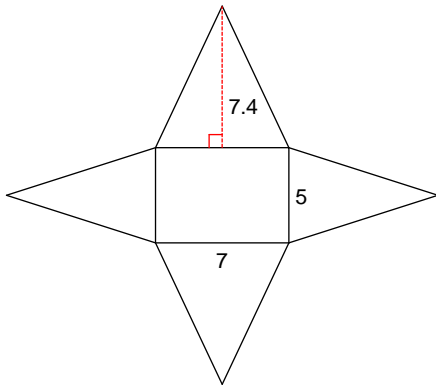

150)

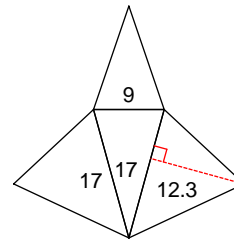

151)

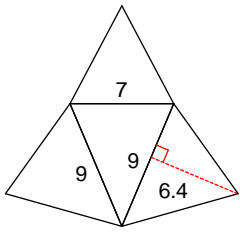

152)

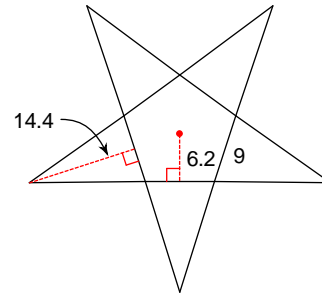

153)

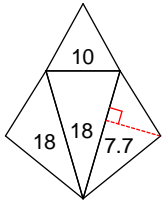

154)

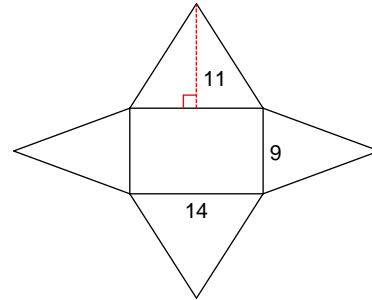

155)

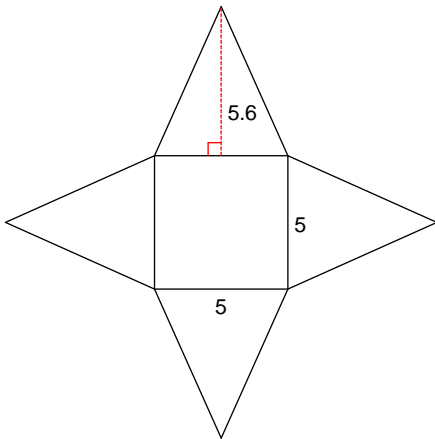

156)

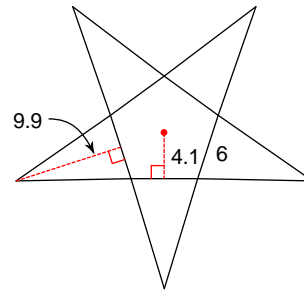

157)

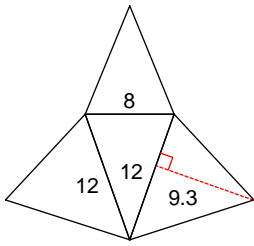

158)

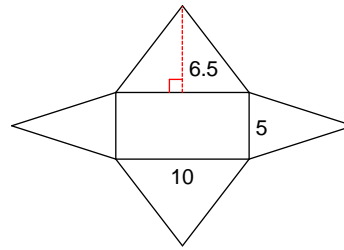

159)

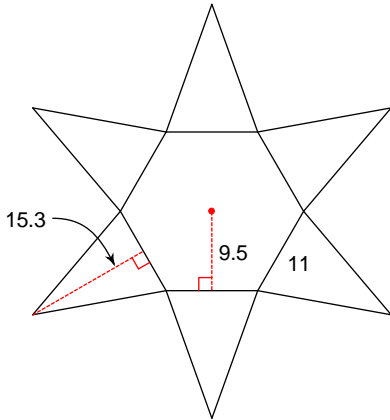

160)

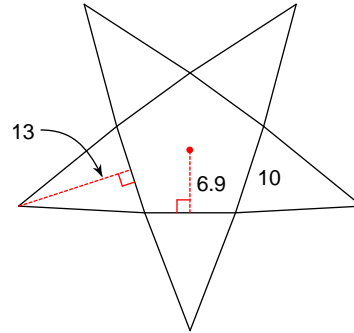

161)

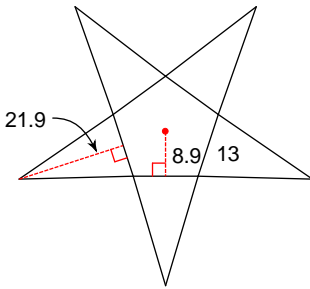

162)

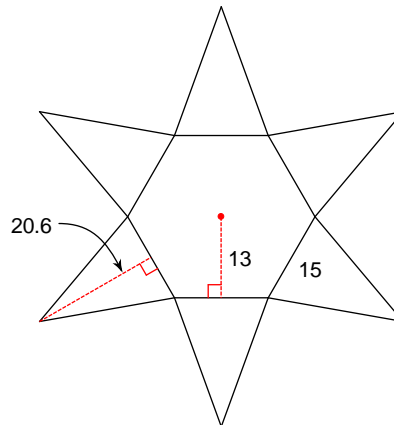

163)

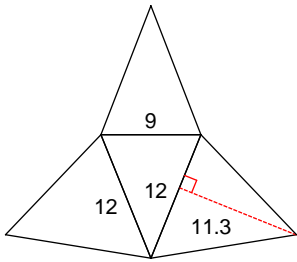

164)

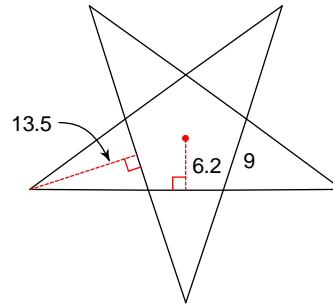

165)

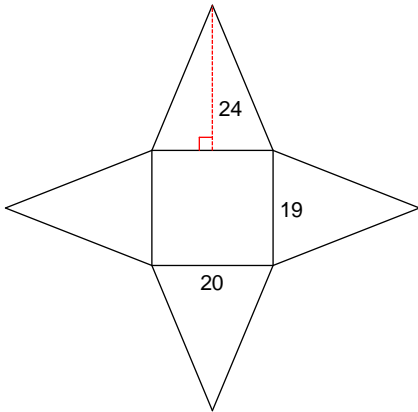

166)

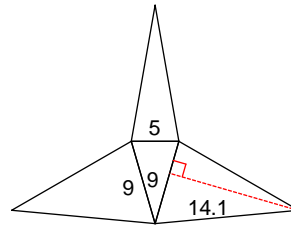

167)

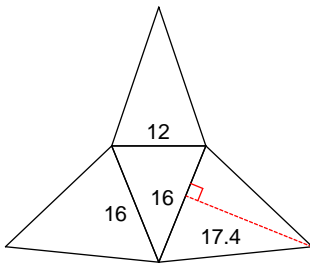

168)

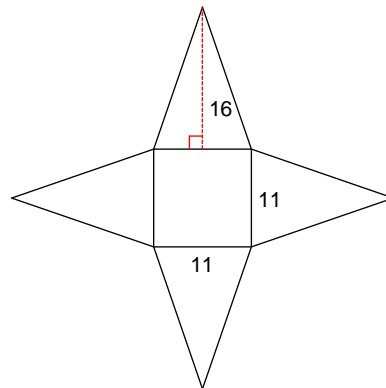

169)

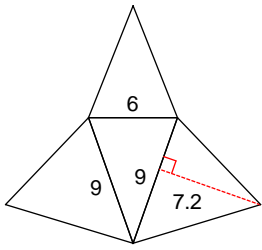

170)

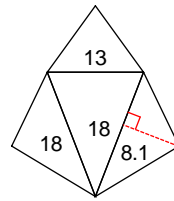

171)

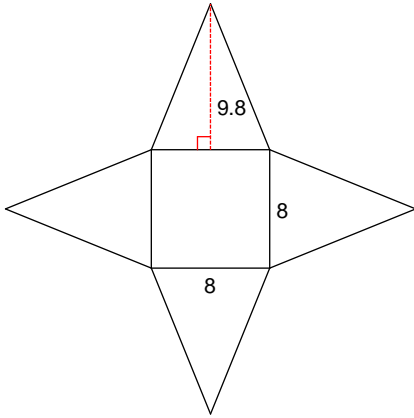

172)

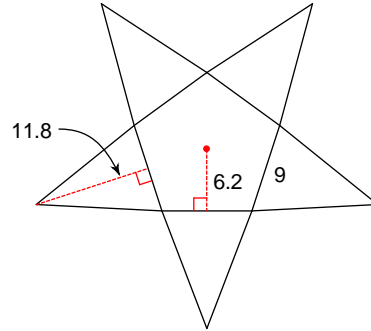

173)

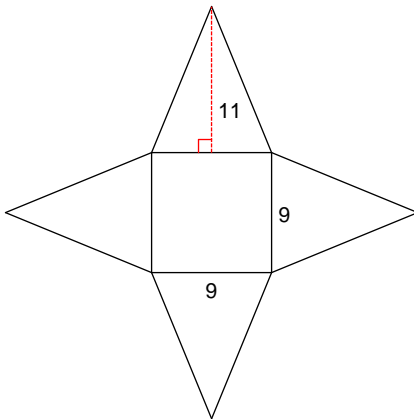

174)

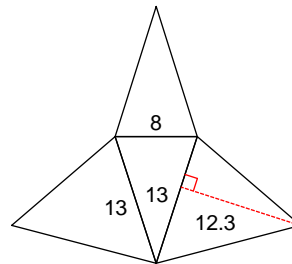

175)

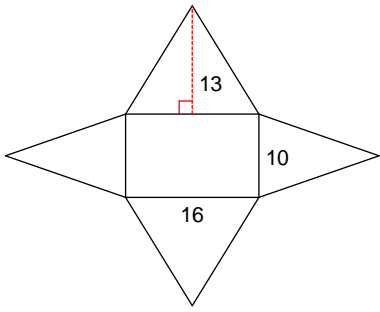

176)

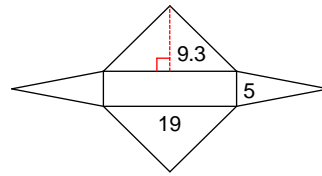

177)

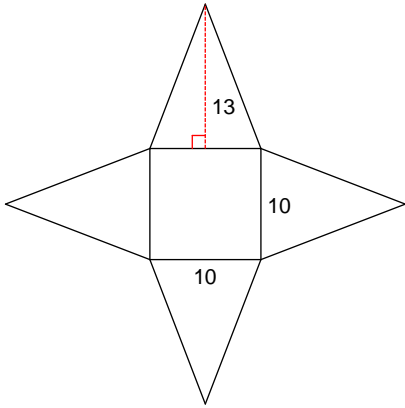

178)

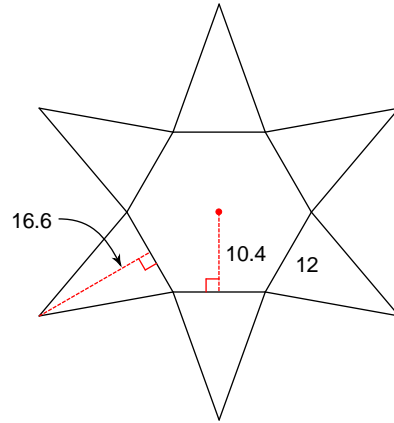

179)

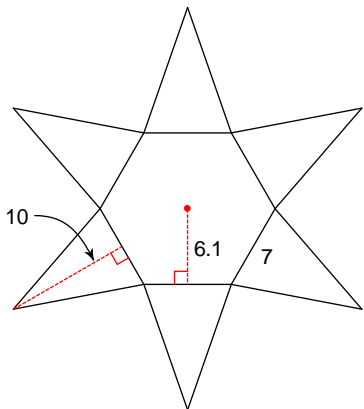

180)

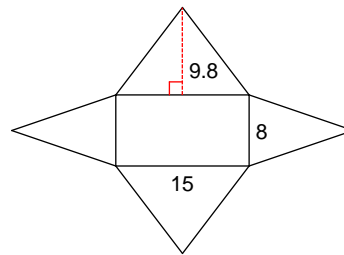

181)

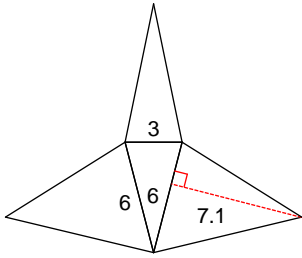

182)

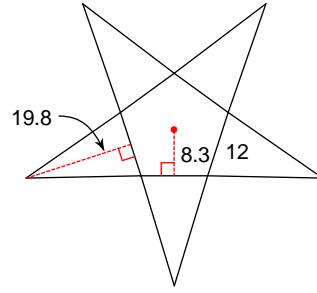

183)

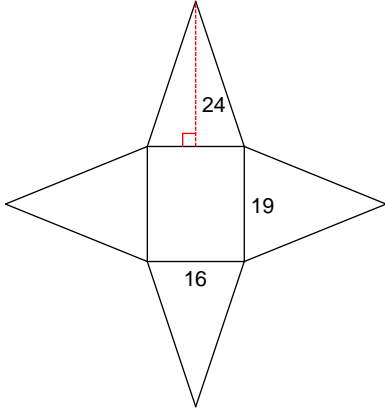

184)

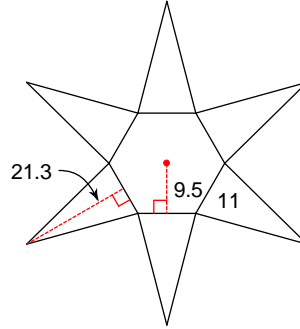

185)

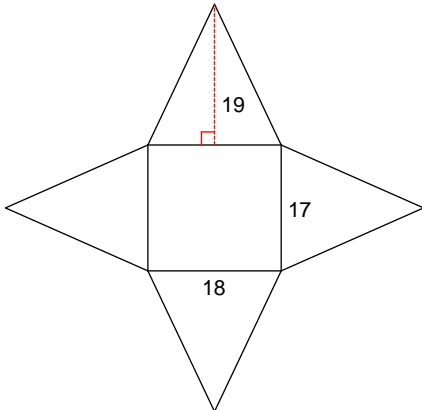

186)

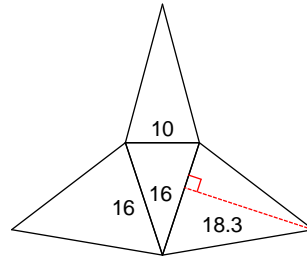

187)

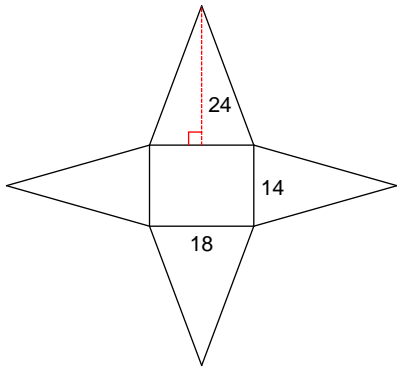

188)

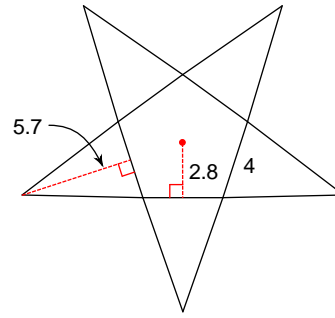

189)

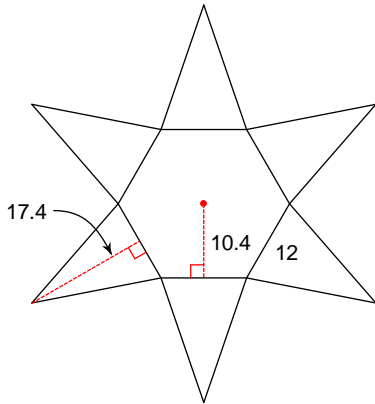

190)

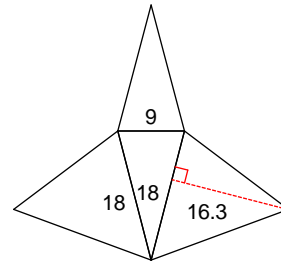

191)

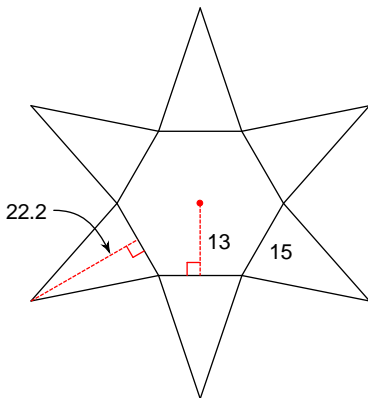

192)

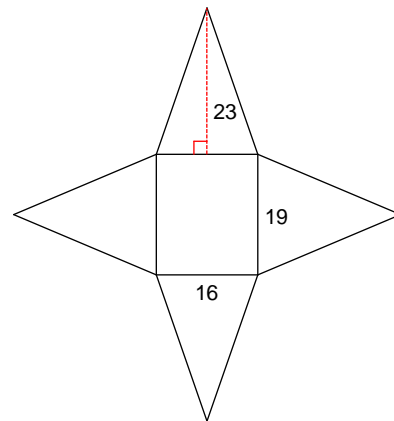

193)

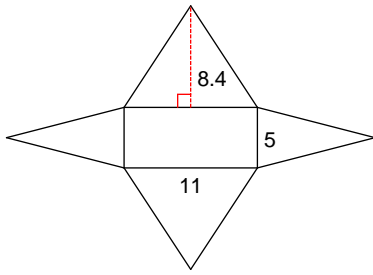

194)

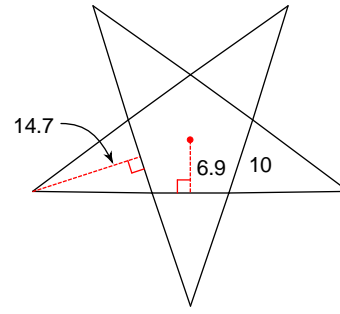

195)

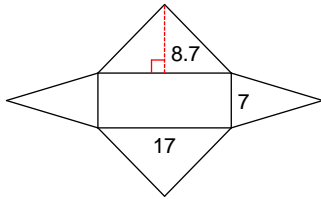

196)

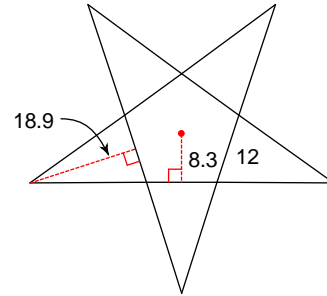

197)

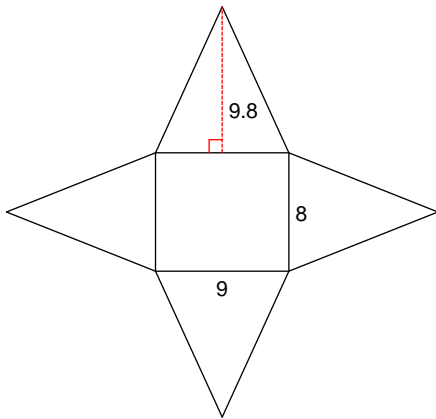

198)

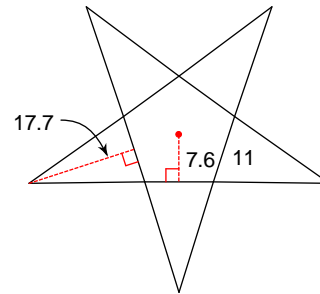

199)

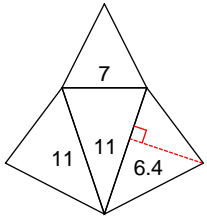

200)

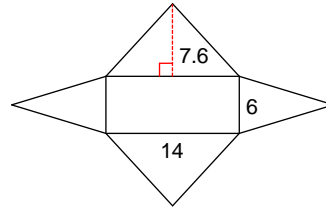

Draw a solid from given net of random solid:

201)

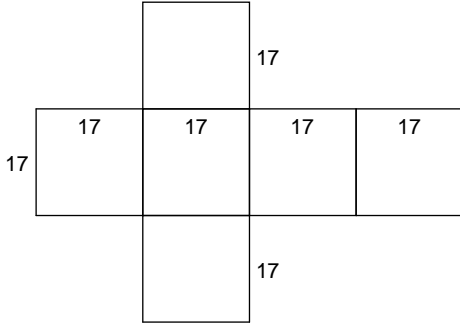

202)

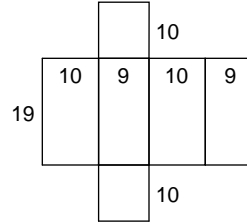

203)

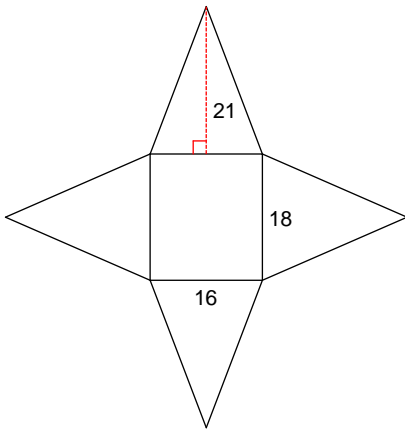

204)

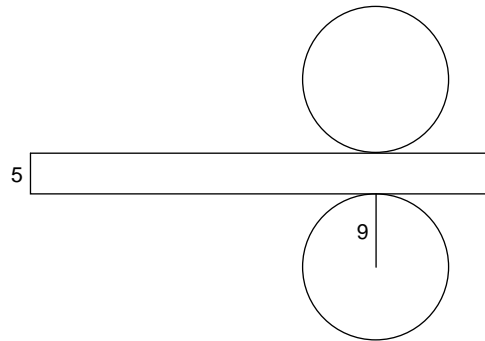

205)

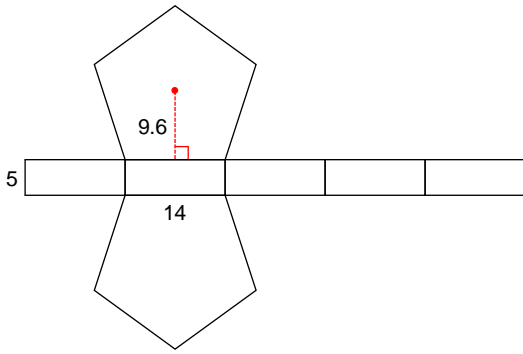

206)

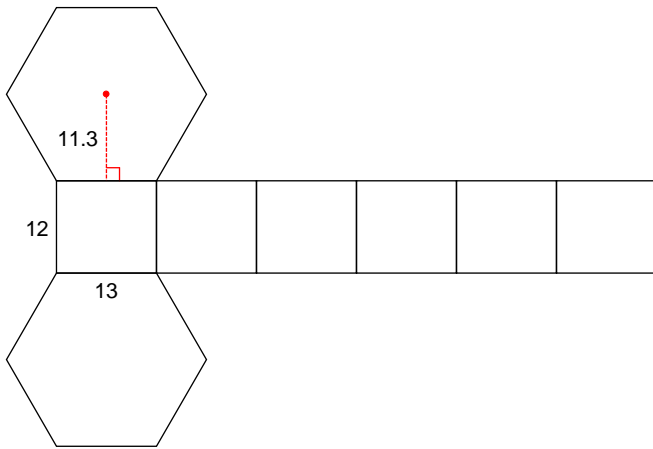

207)

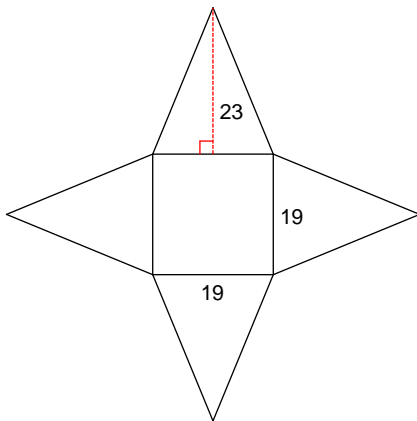

208)

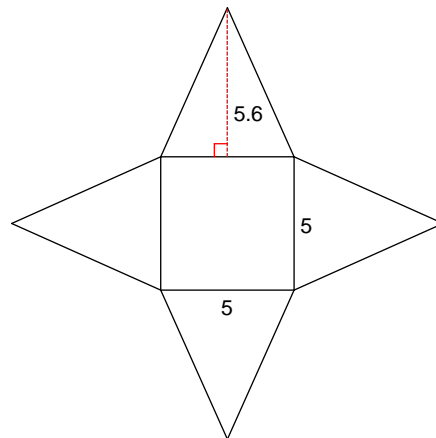

209)

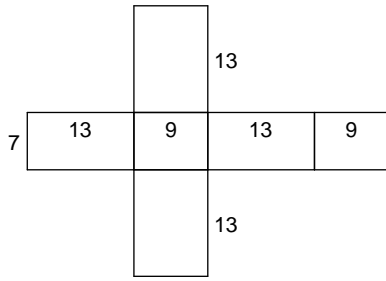

210)

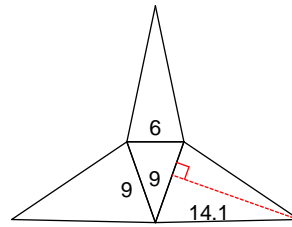

211)

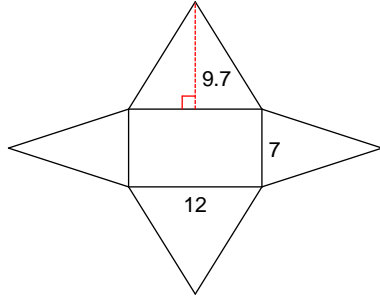

212)

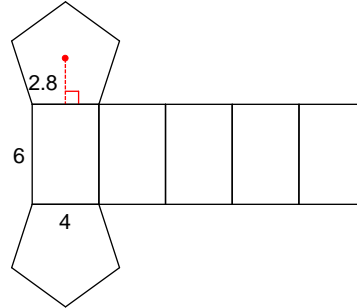

213)

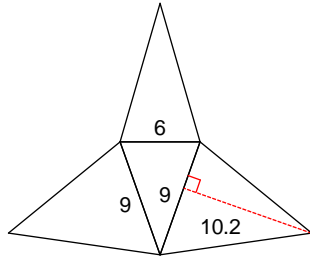

214)

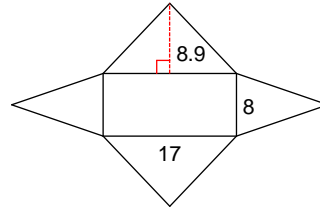

215)

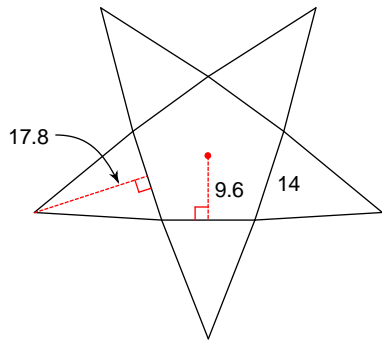

216)

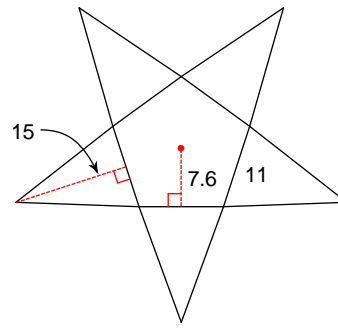

217)

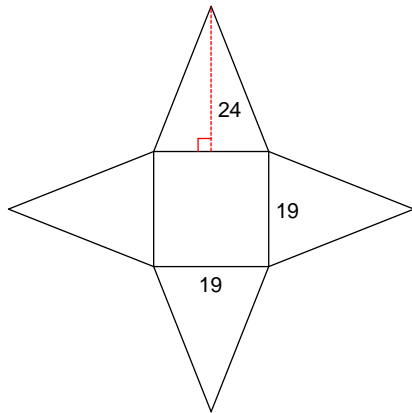

218)

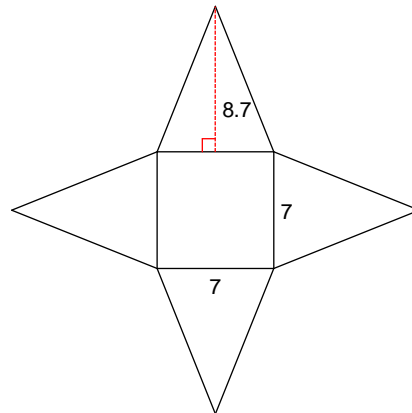

219)

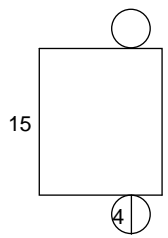

220)

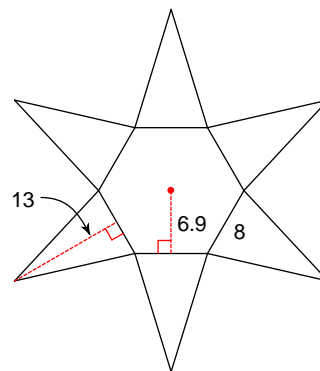

221)

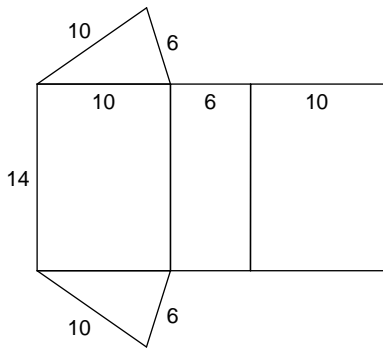

222)

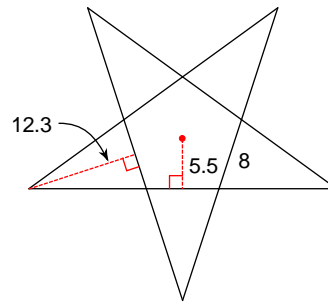

223)

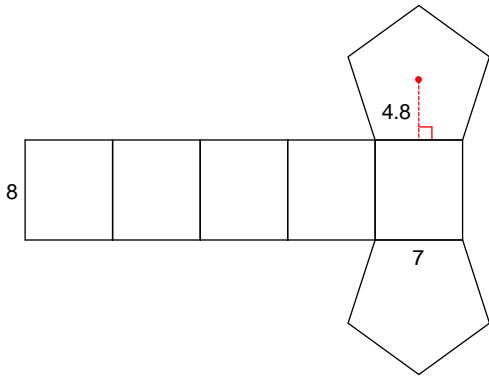

224)

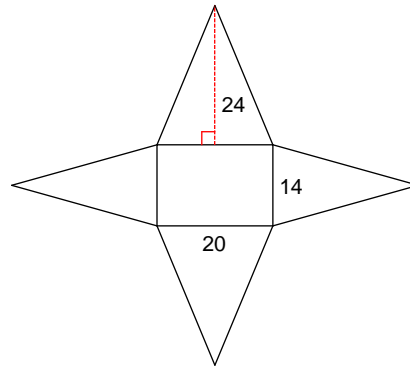

225)

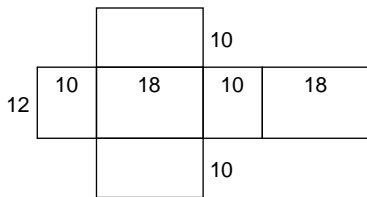

226)

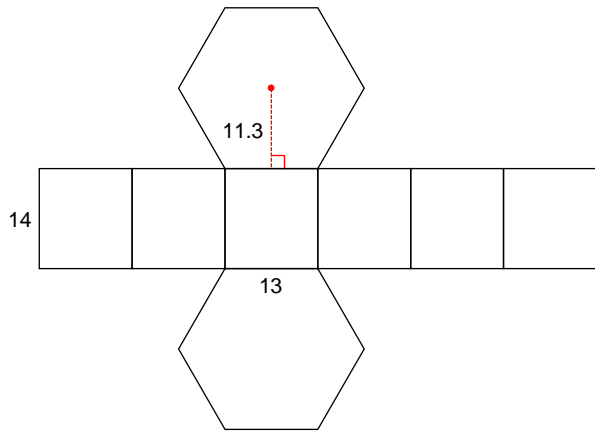

227)

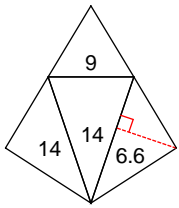

228)

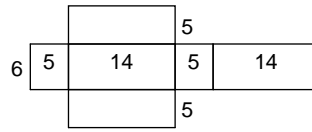

229)

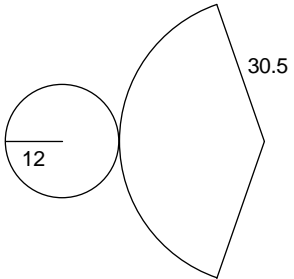

230)

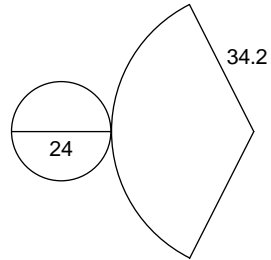

231)

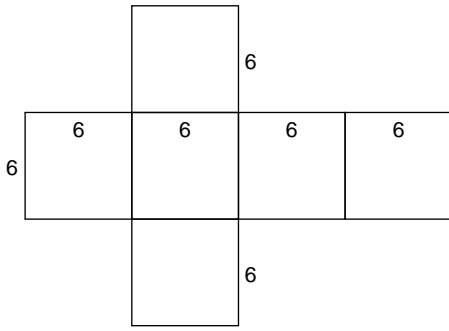

232)

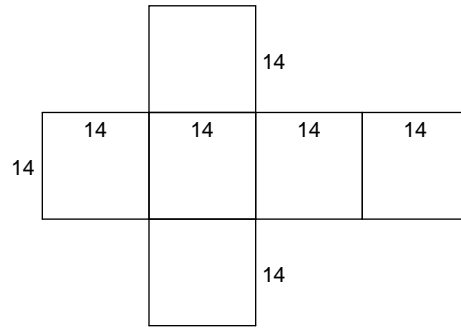

233)

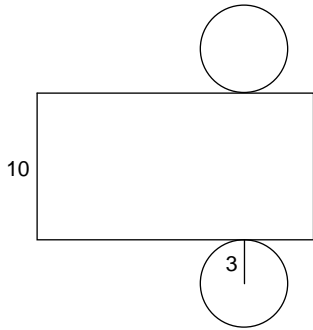

234)

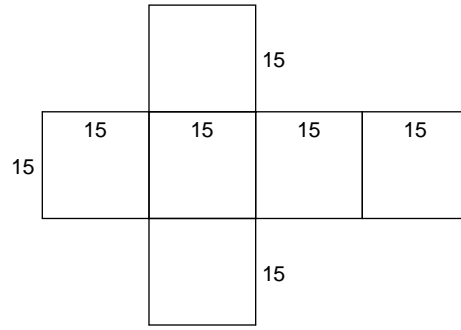

235)

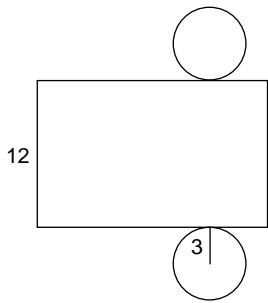

236)

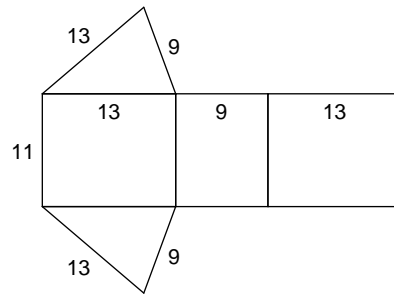

237)

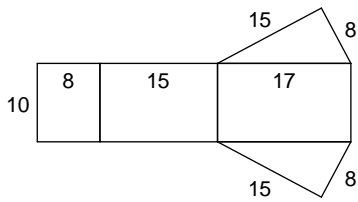

238)

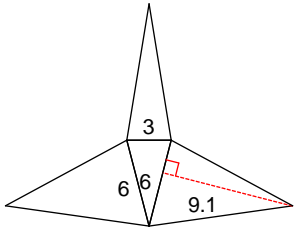

239)

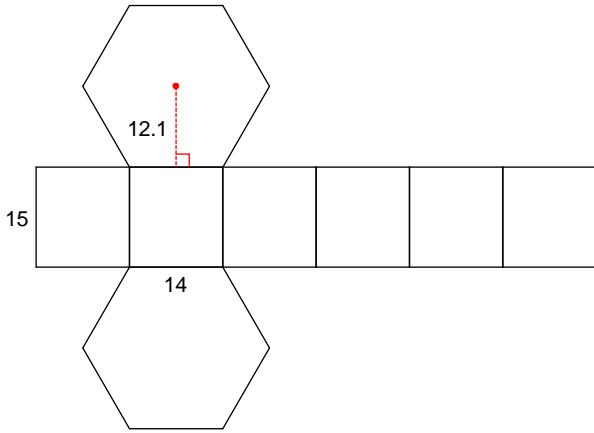

240)

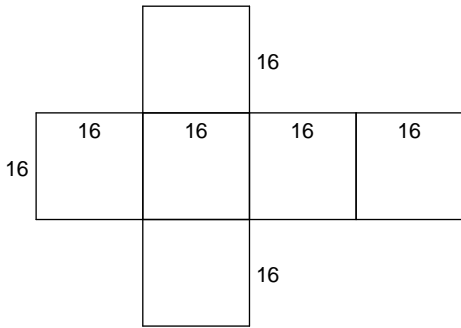

241)

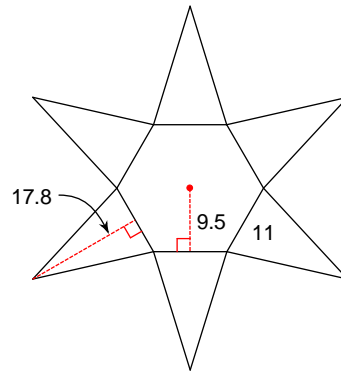

242)

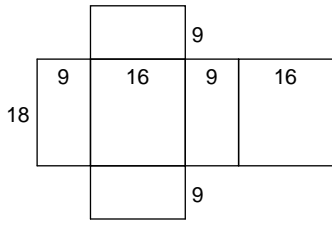

243)

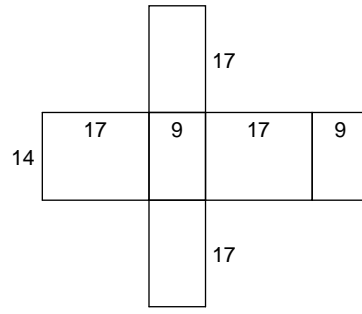

244)

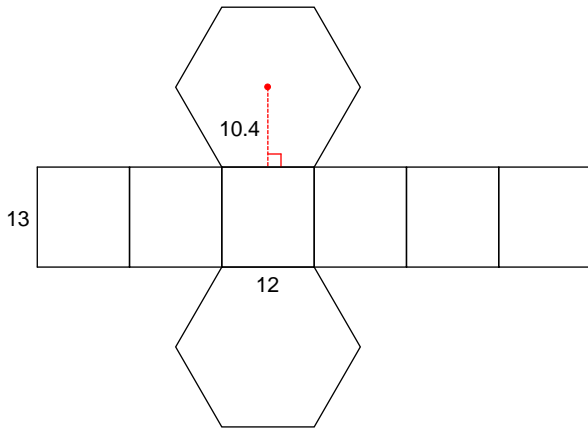

245)

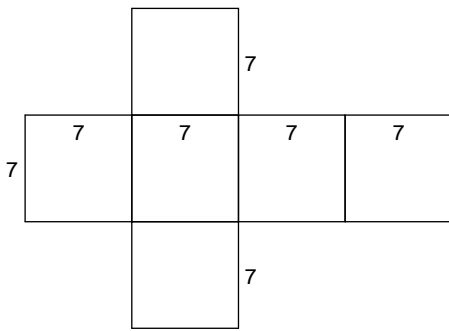

246)

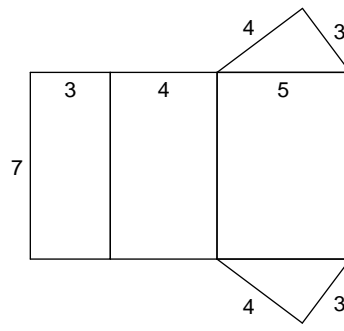

247)

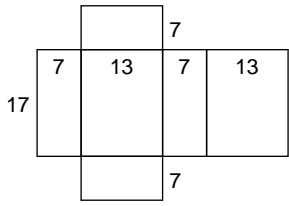

248)

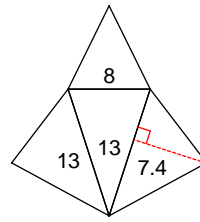

249)

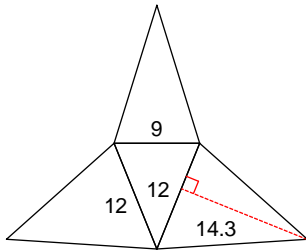

250)

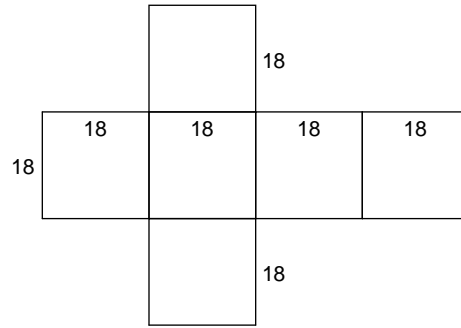

251)

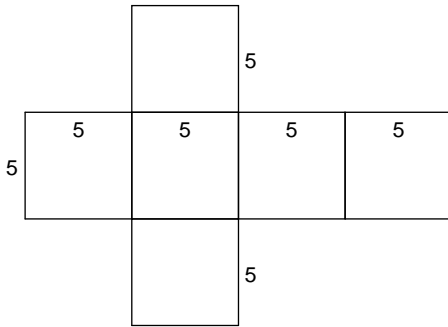

252)

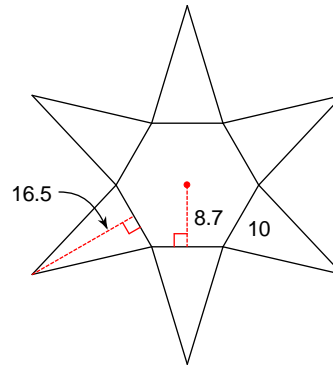

253)

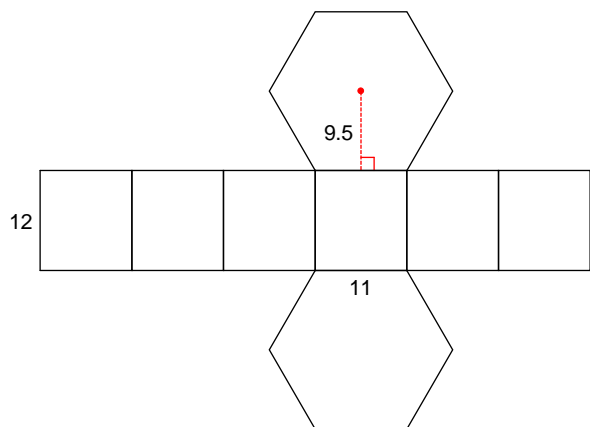

254)

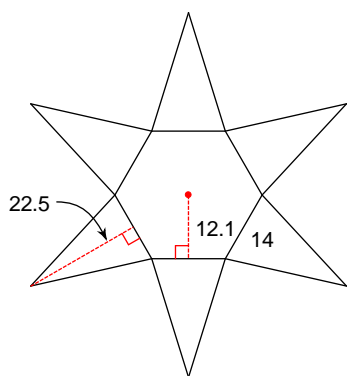

255)

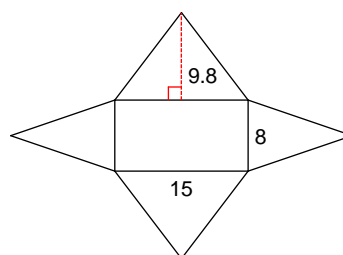

256)

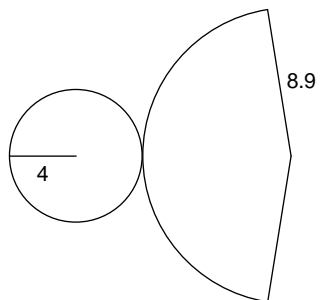

257)

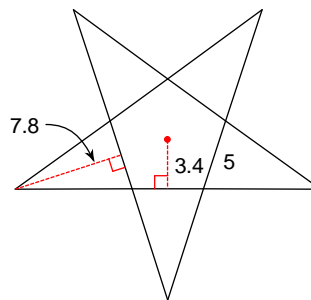

258)

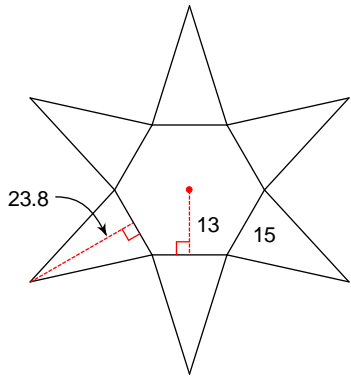

259)

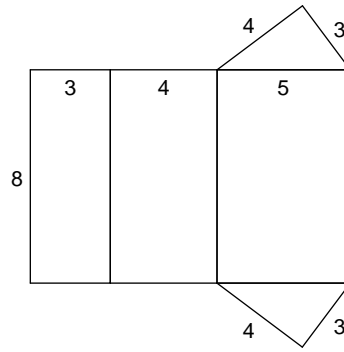

260)

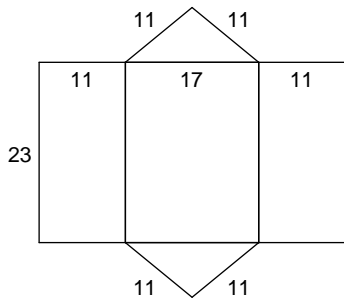

261)

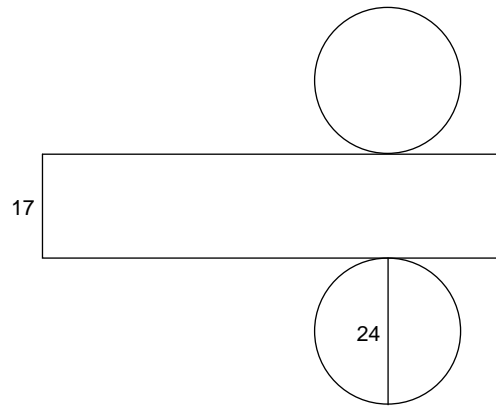

262)

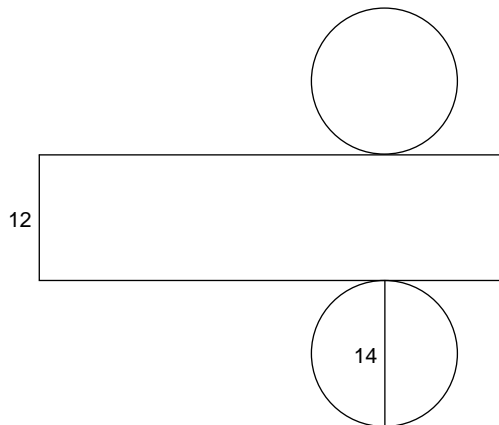

263)

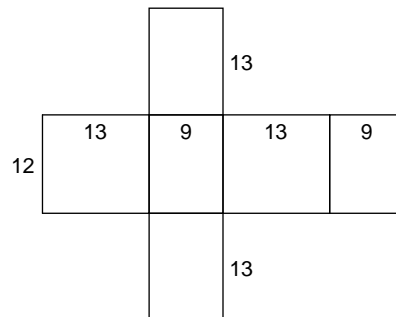

264)

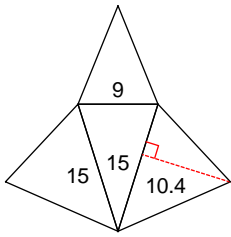

265)

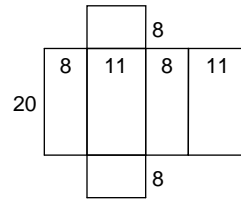

266)

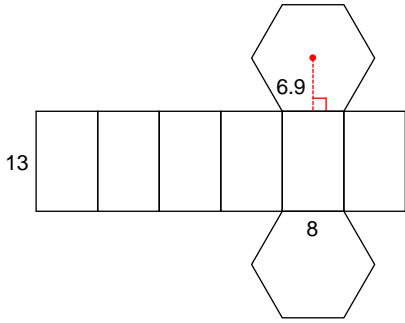

267)

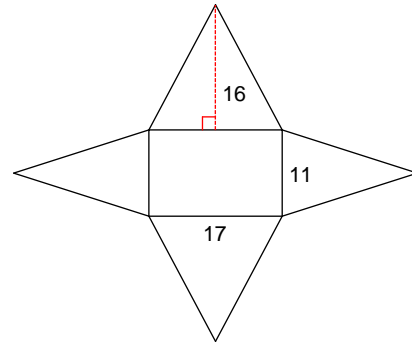

268)

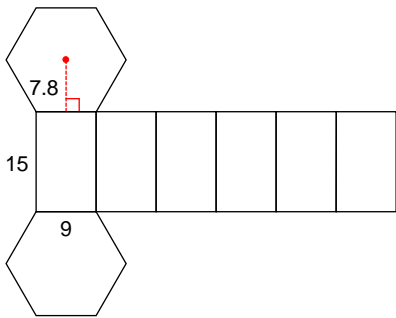

269)

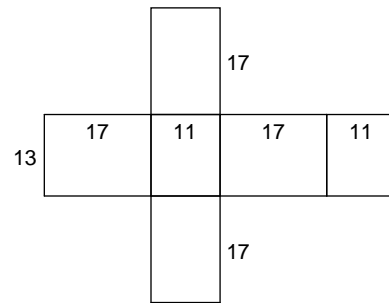

270)

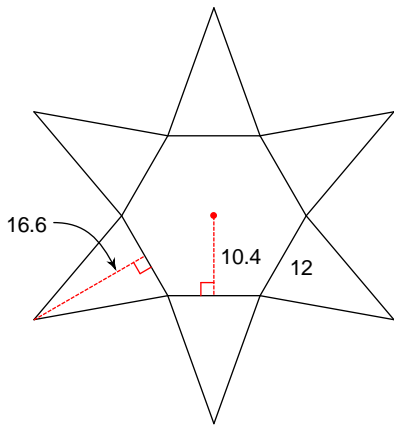

271)

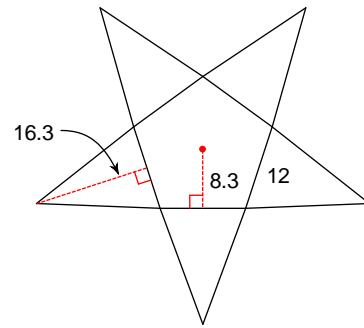

272)

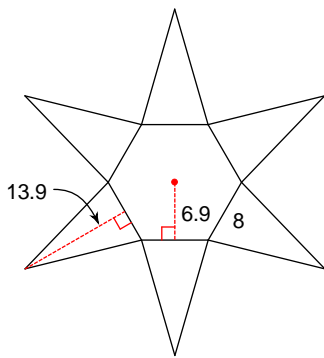

273)

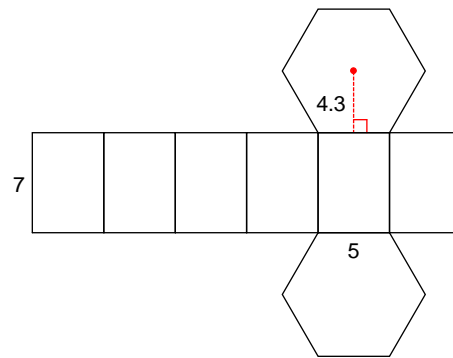

274)

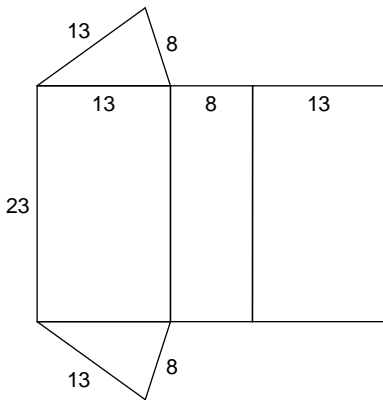

275)

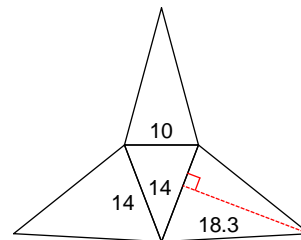

276)

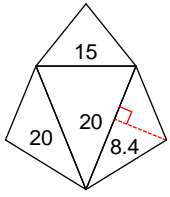

277)

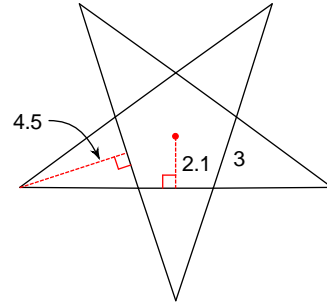

278)

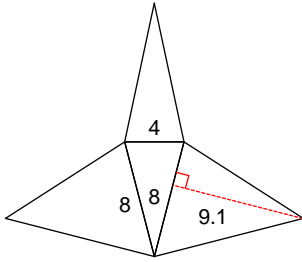

279)

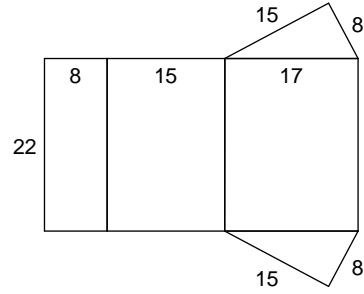

280)

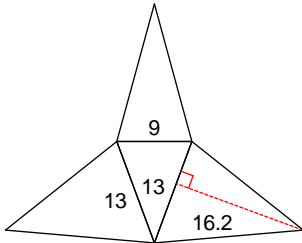

281)

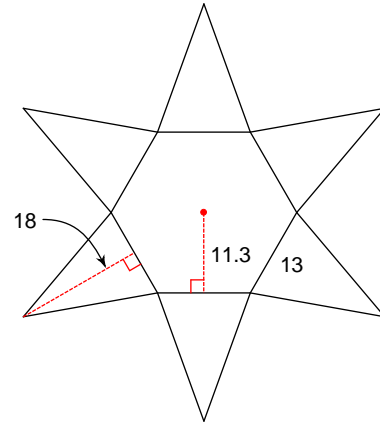

282)

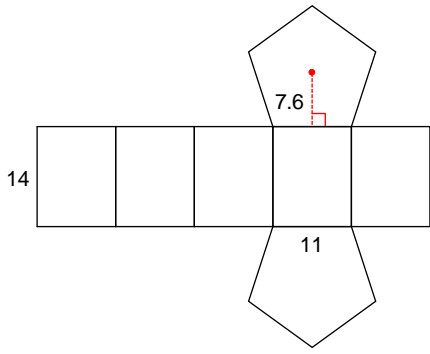

283)

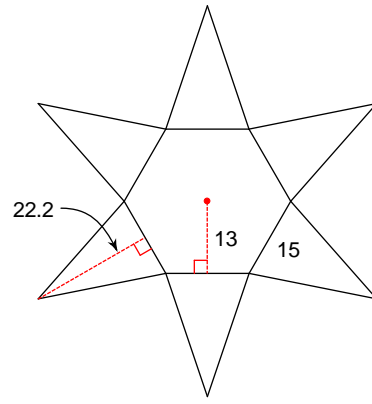

284)

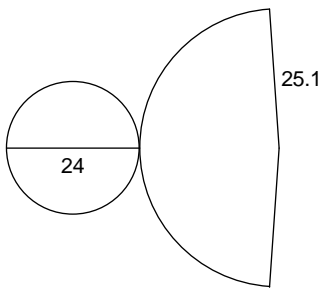

285)

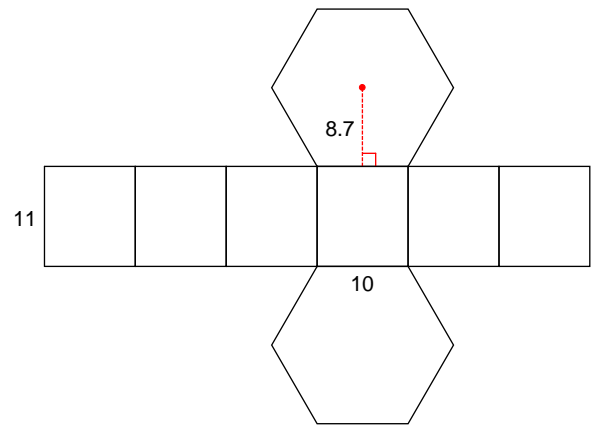

286)

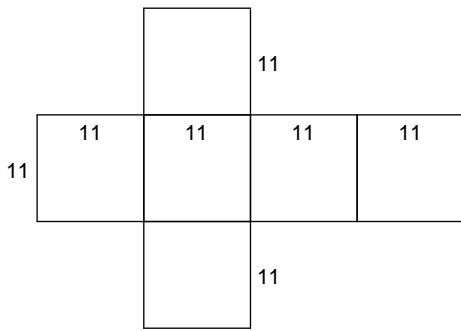

287)

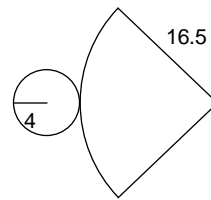

288)

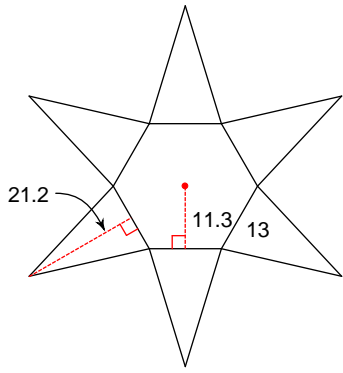

289)

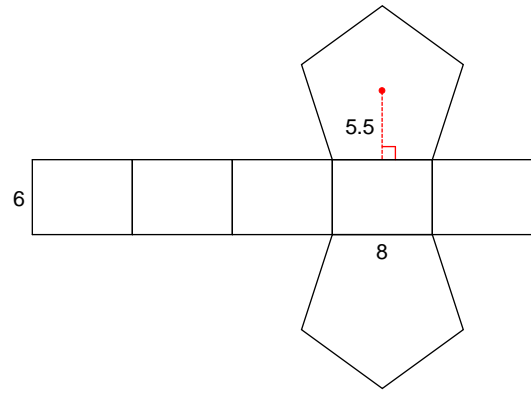

290)

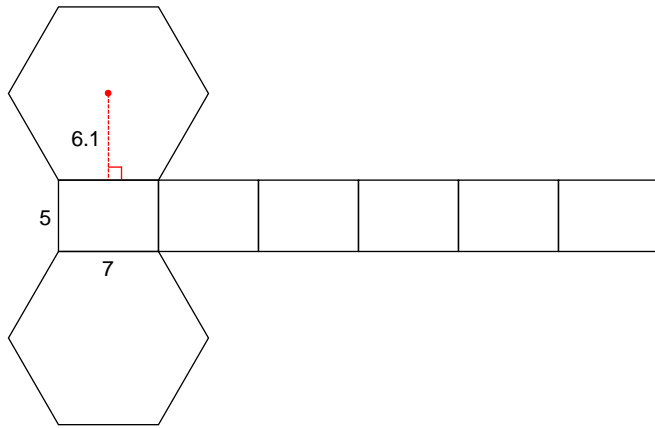

291)

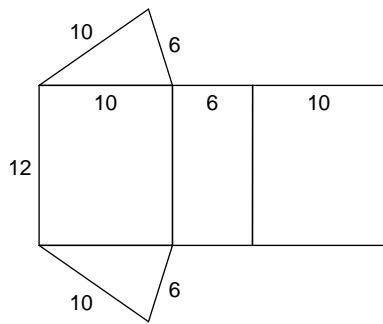

292)

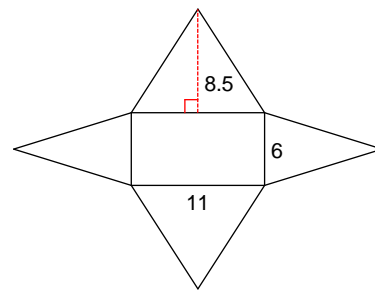

293)

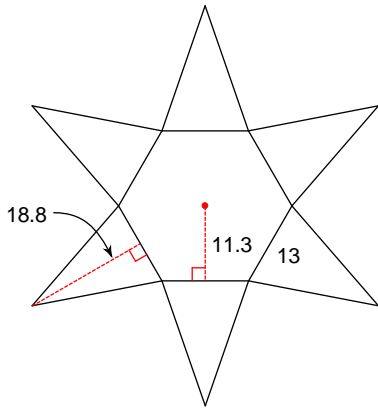

294)

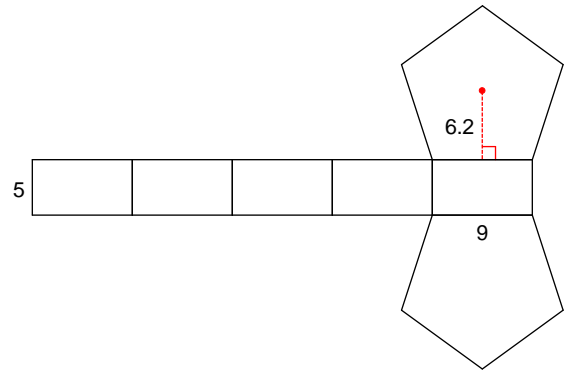

295)

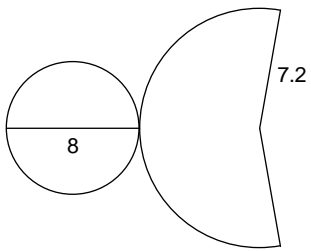

296)

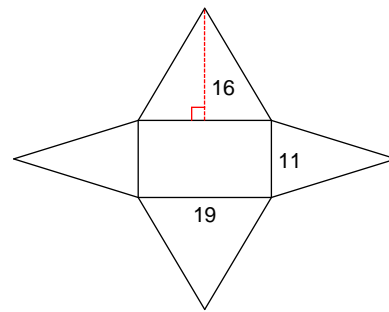

297)

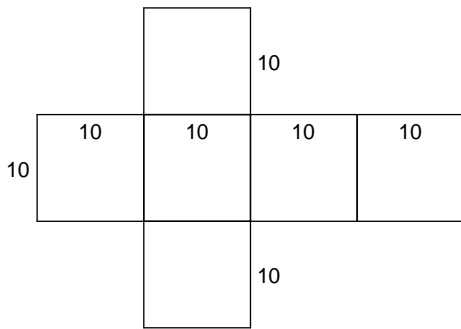

298)

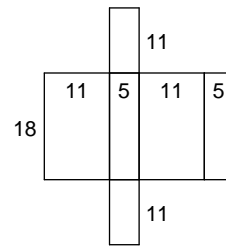

299)

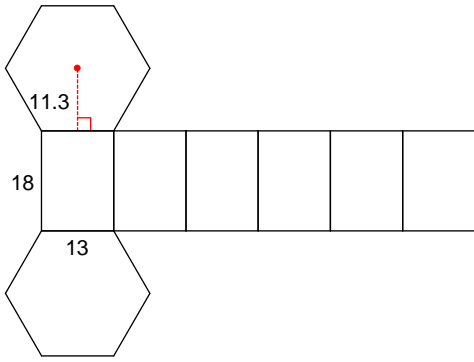

300)

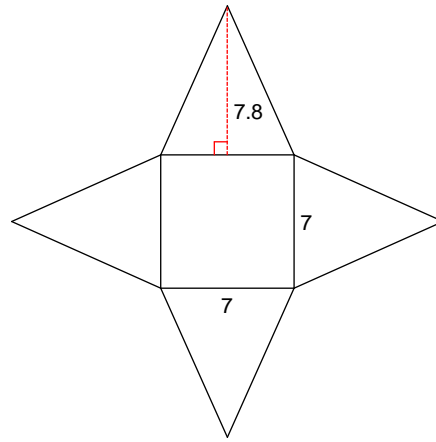

301)

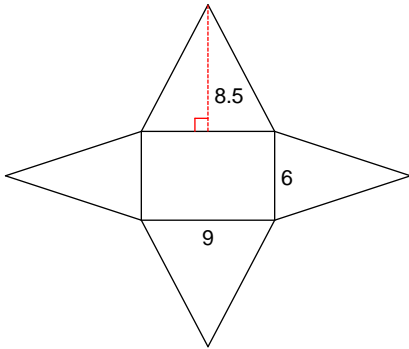

302)

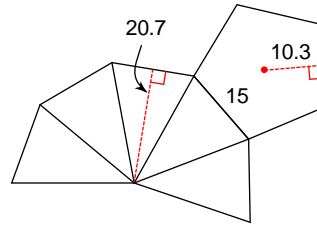

303)

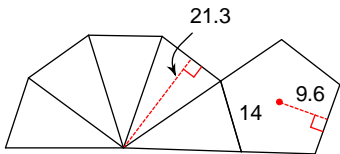

304)

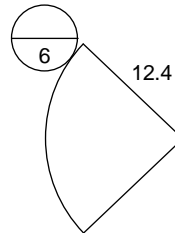

305)

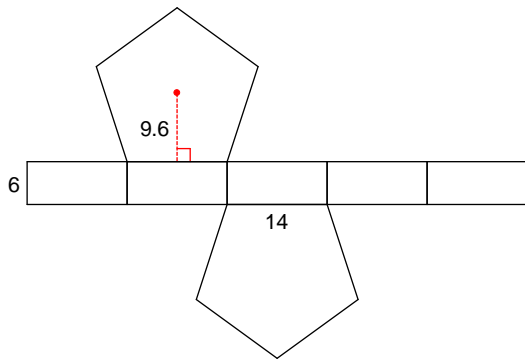

306)

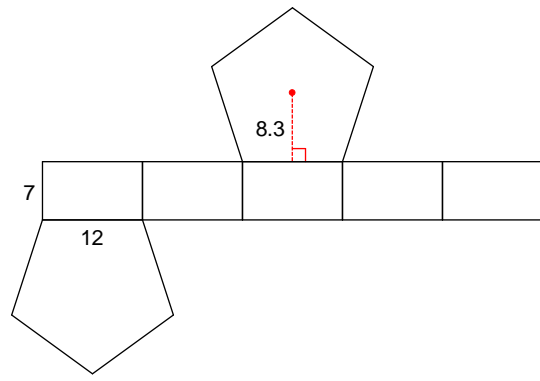

307)

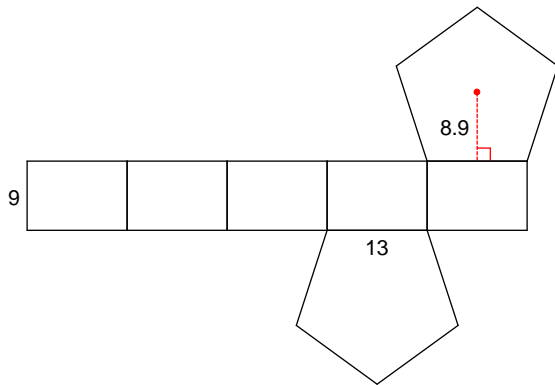

308)

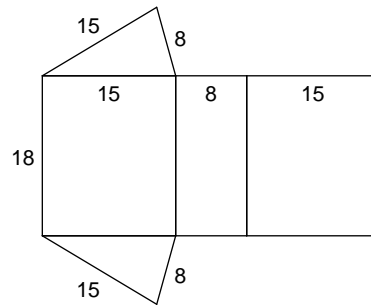

309)

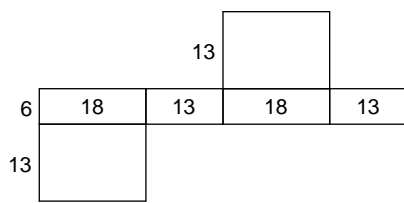

310)

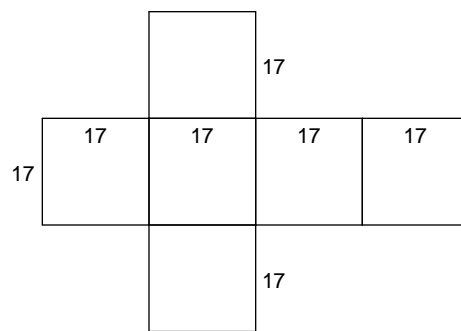

311)

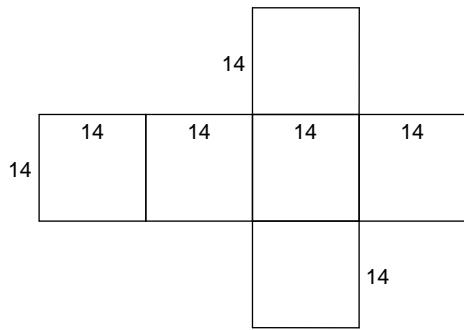

312)

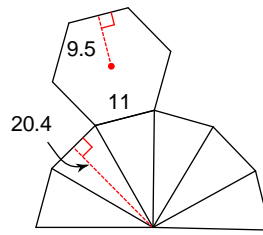

313)

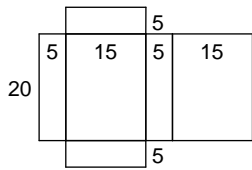

314)

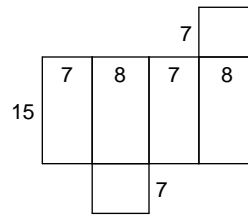

315)

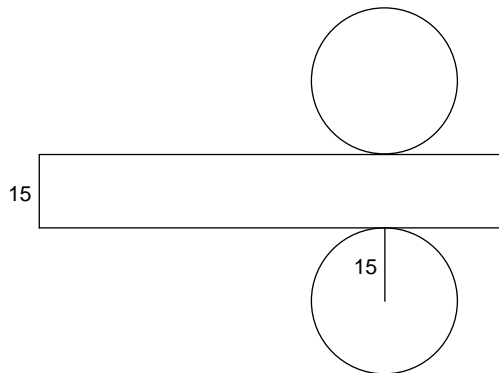

316)

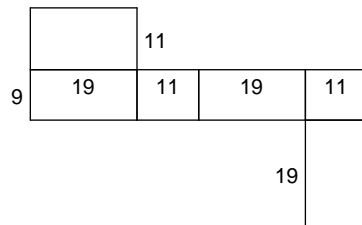

317)

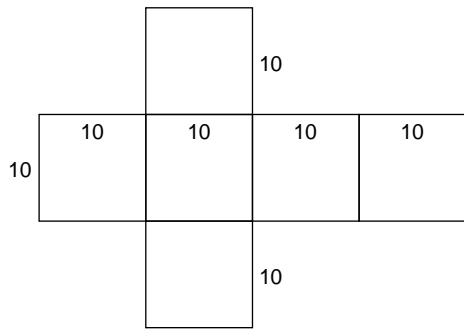

318)

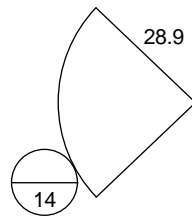

319)

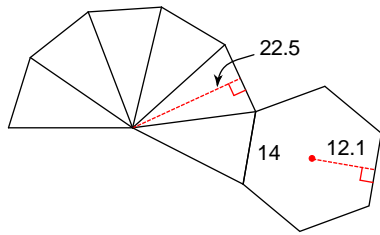

320)

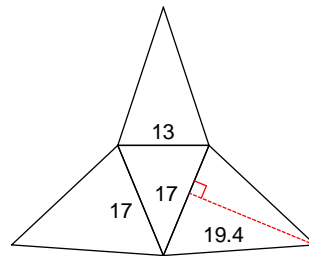

321)

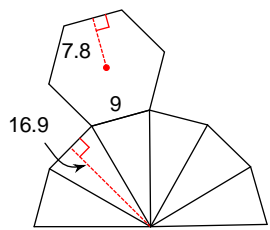

322)

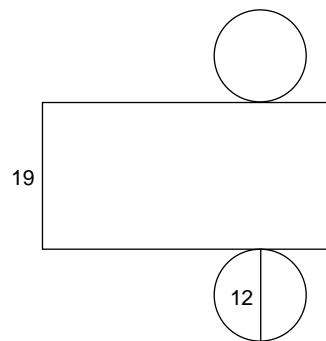

323)

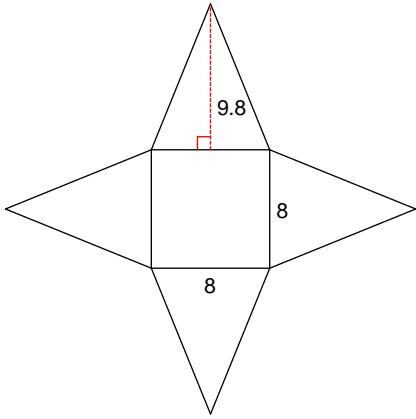

324)

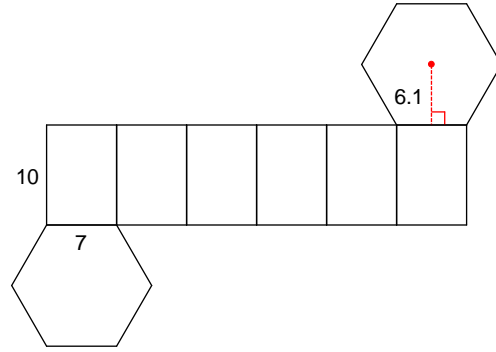

325)

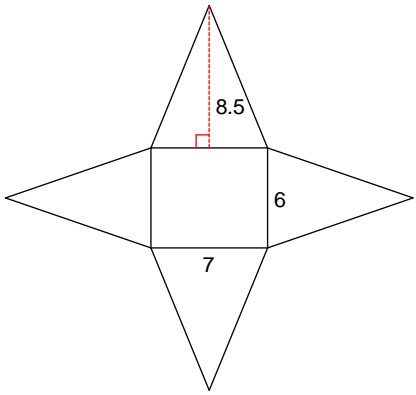

326)

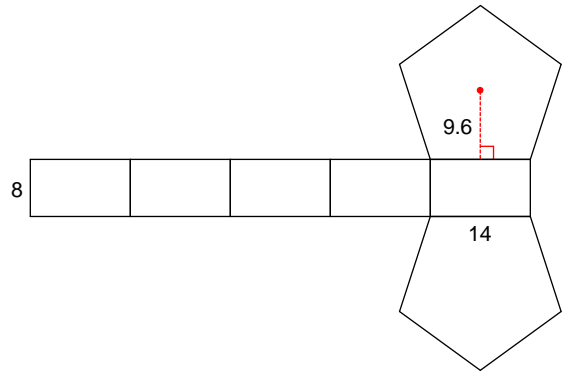

327)

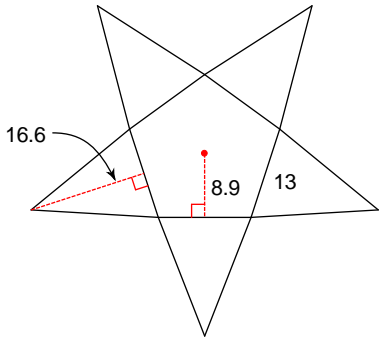

328)

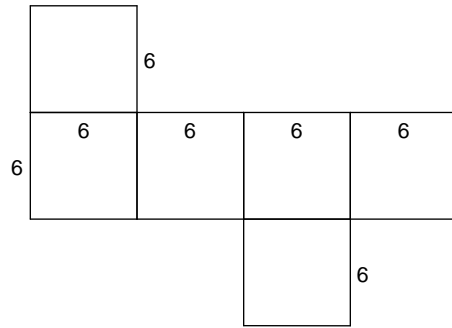

329)

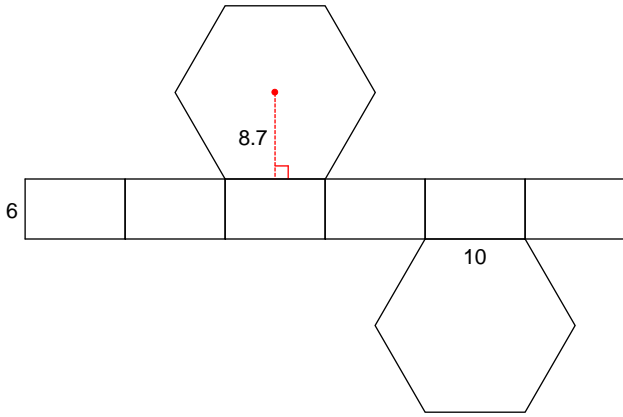

330)

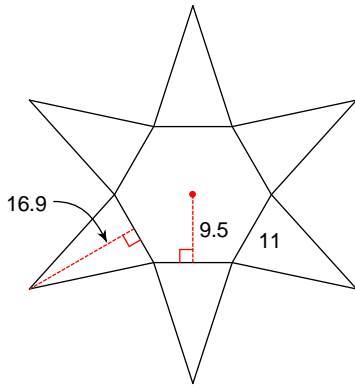

331)

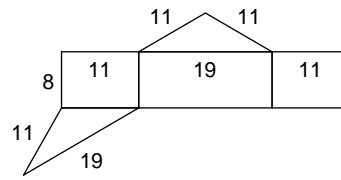

332)

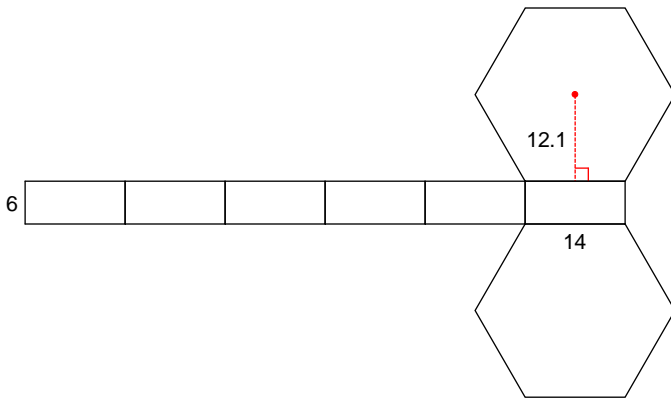

333)

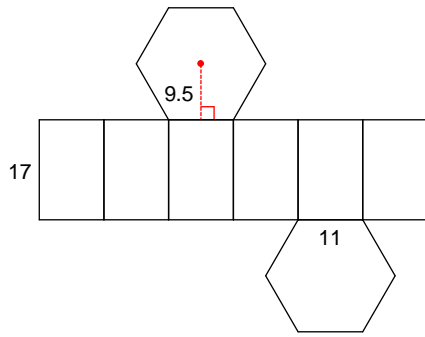

334)

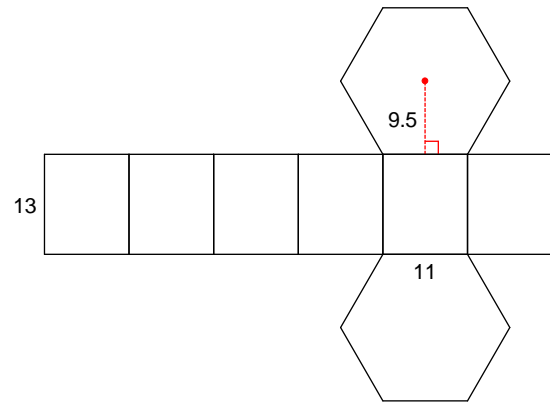

335)

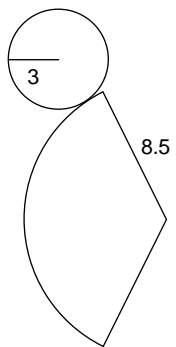

336)

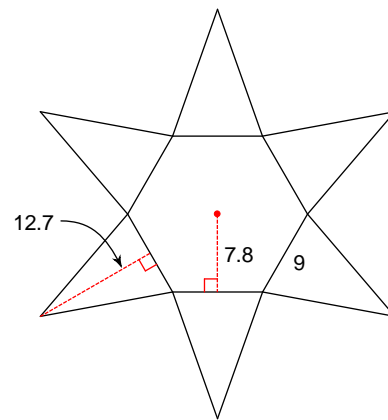

337)

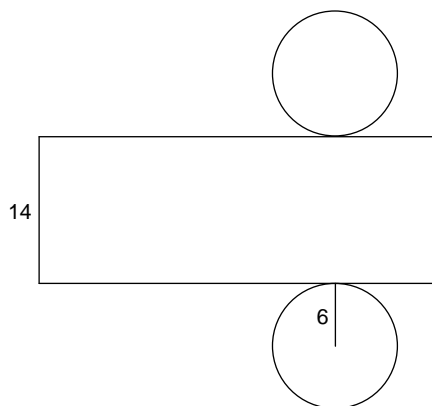

338)

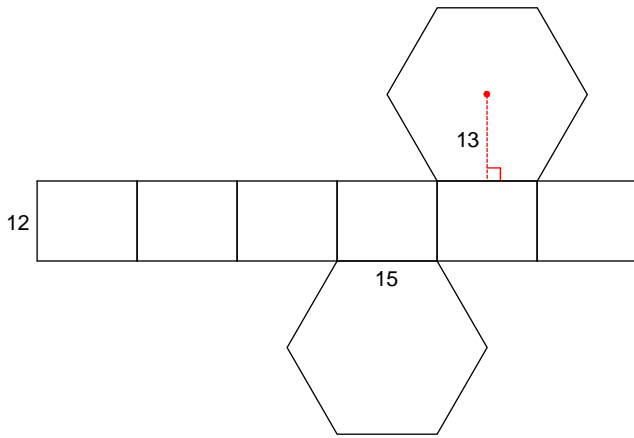

339)

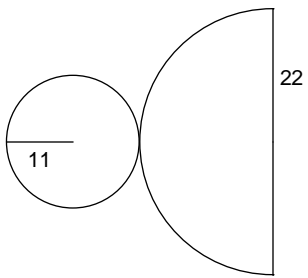

340)

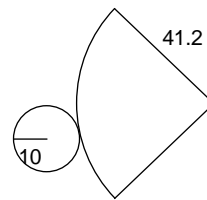

341)

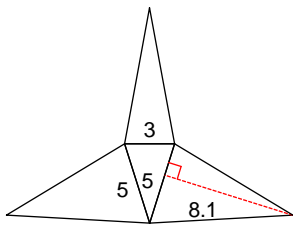

342)

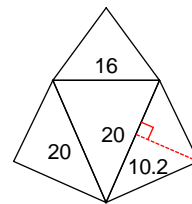

343)

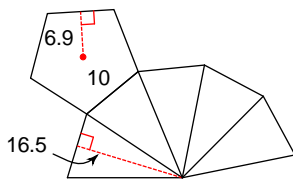

344)

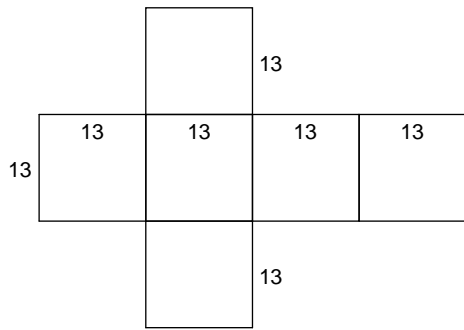

345)

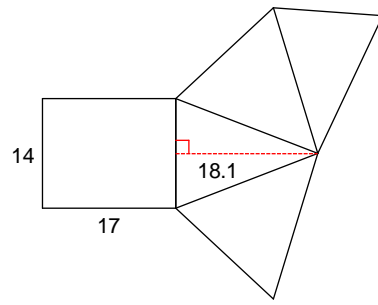

346)

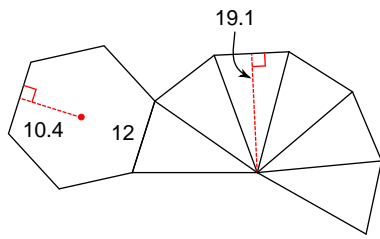

347)

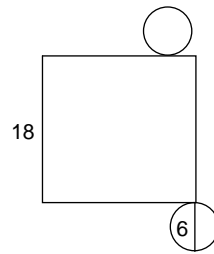

348)

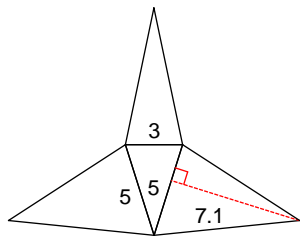

349)

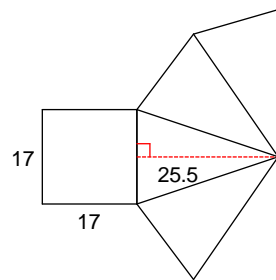

350)

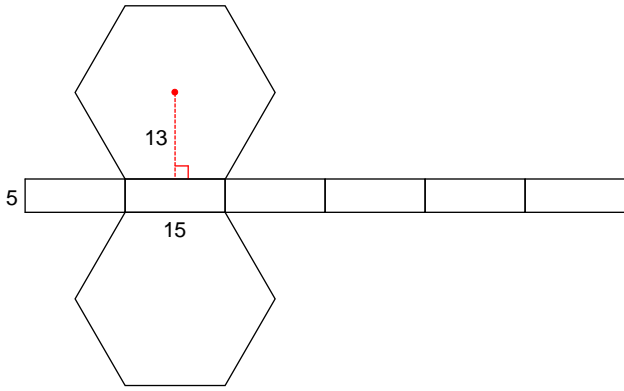

351)

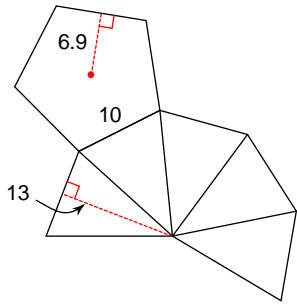

352)

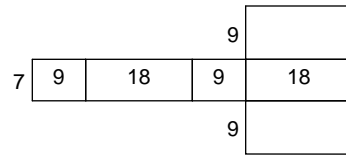

353)

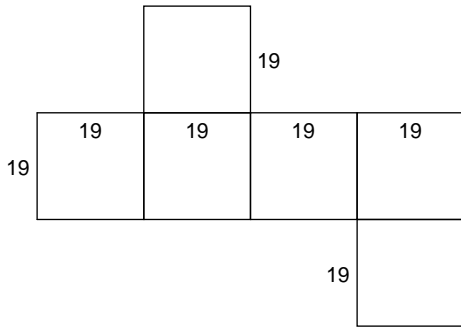

354)

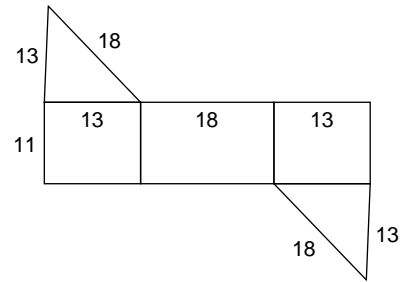

355)

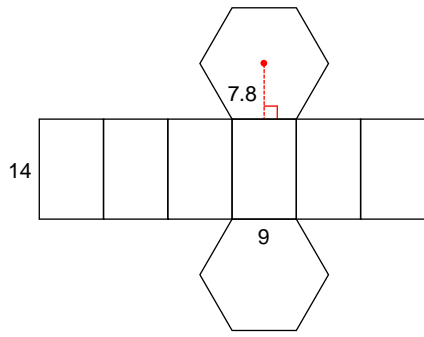

356)

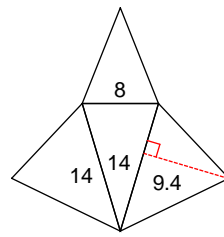

357)

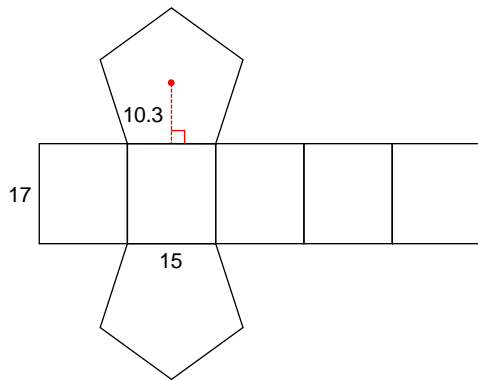

358)

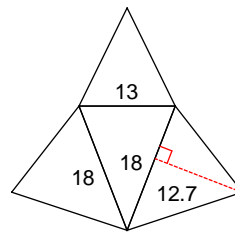

359)

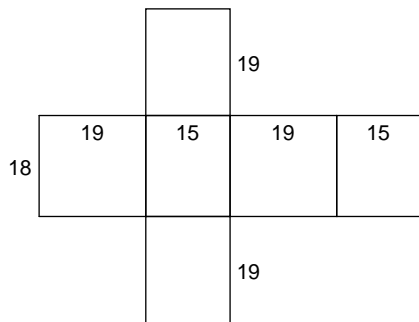

360)

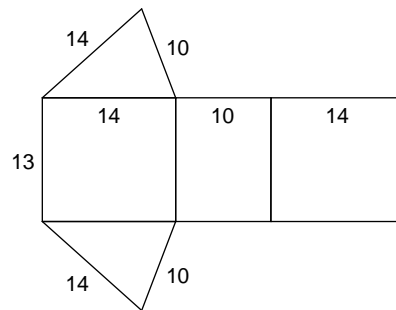

361)

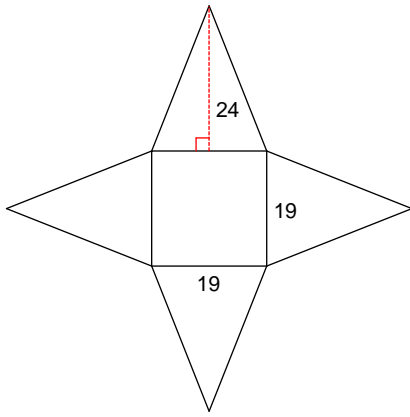

362)

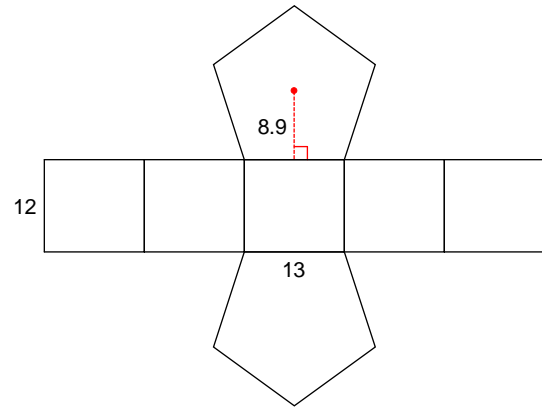

363)

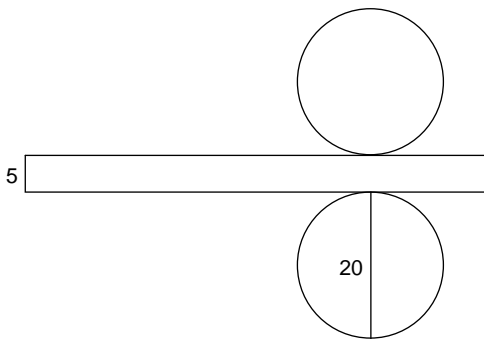

364)

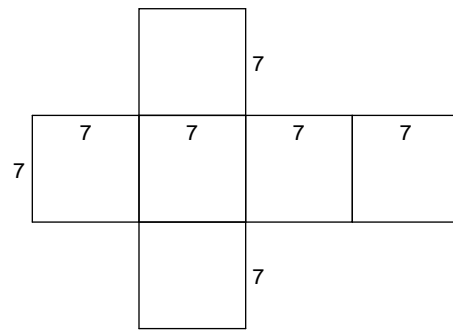

365)

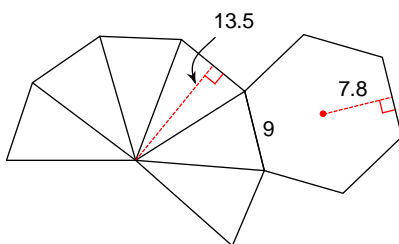

366)

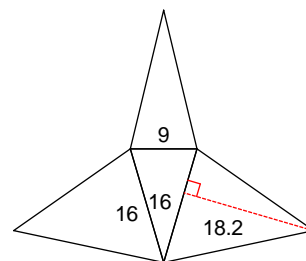

367)

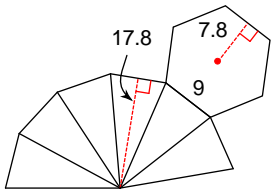

368)

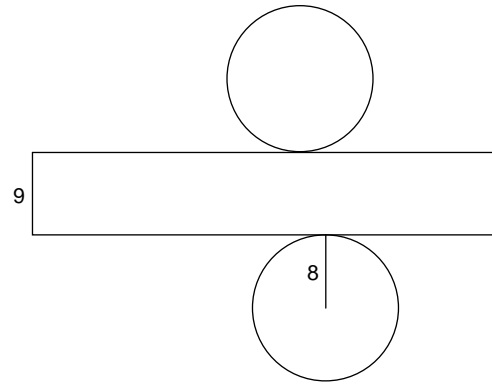

369)

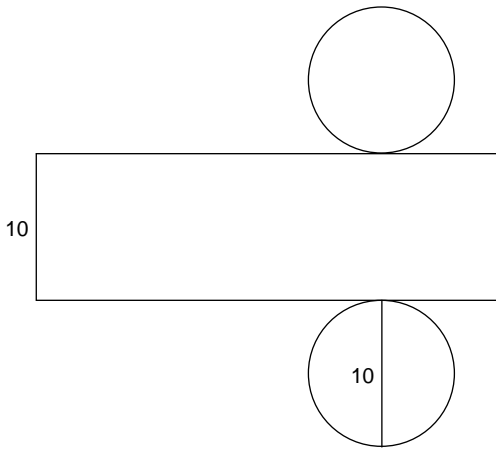

370)

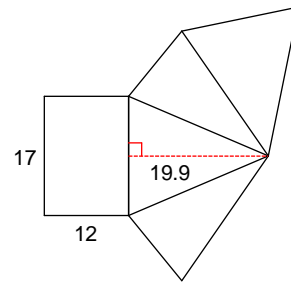

371)

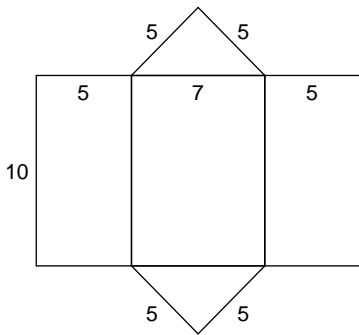

372)

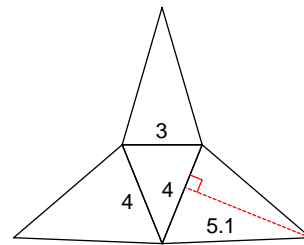

373)

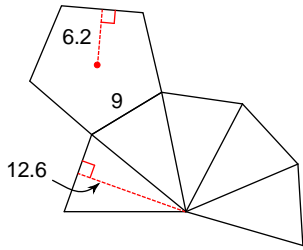

374)

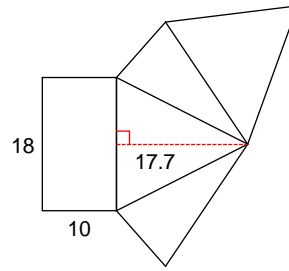

375)

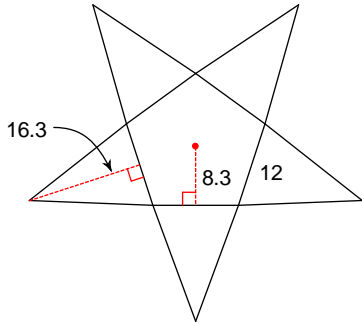

376)

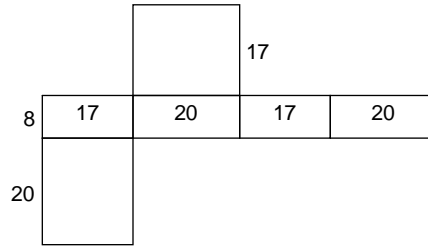

377)

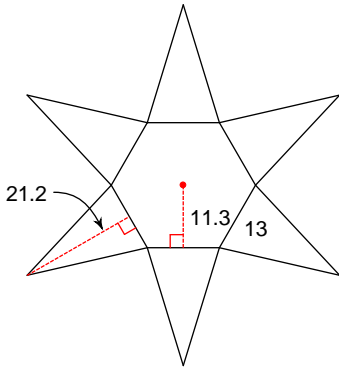

378)

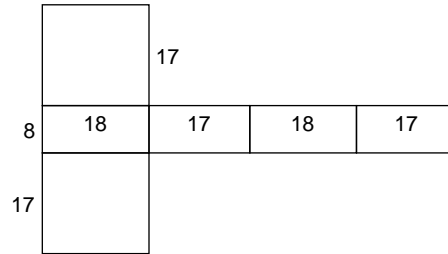

379)

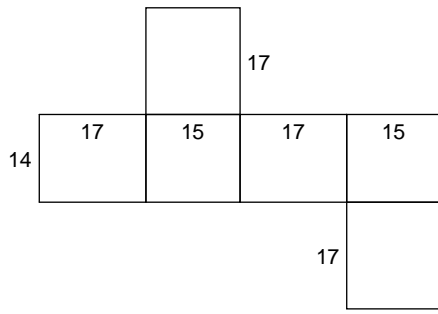

380)

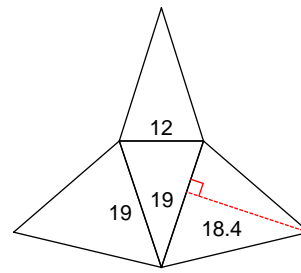

381)

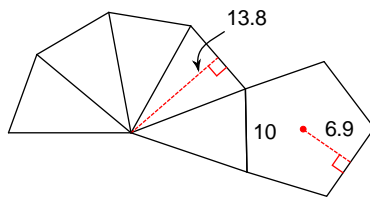

382)

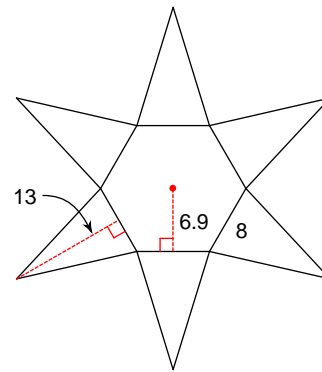

383)

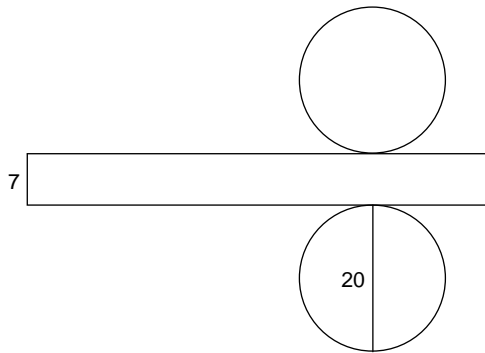

384)

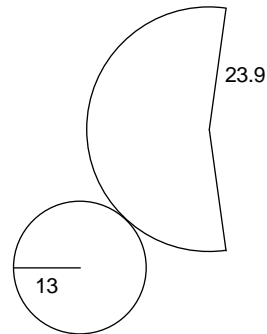

385)

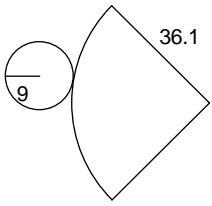

386)

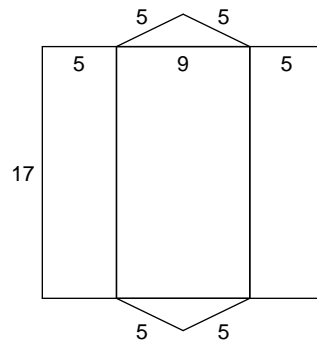

387)

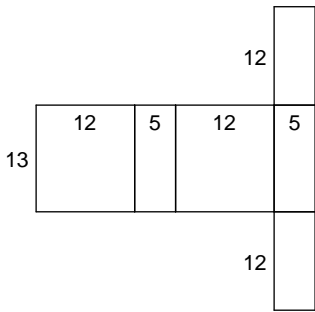

388)

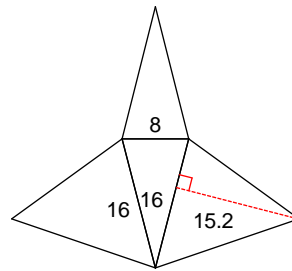

389)

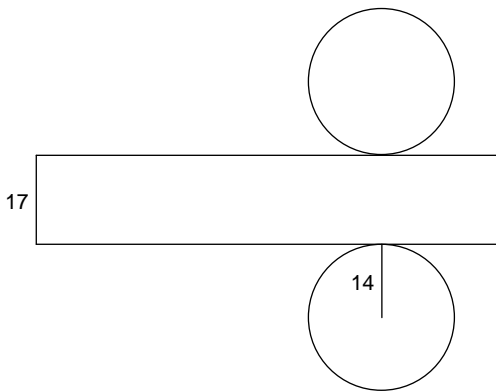

390)

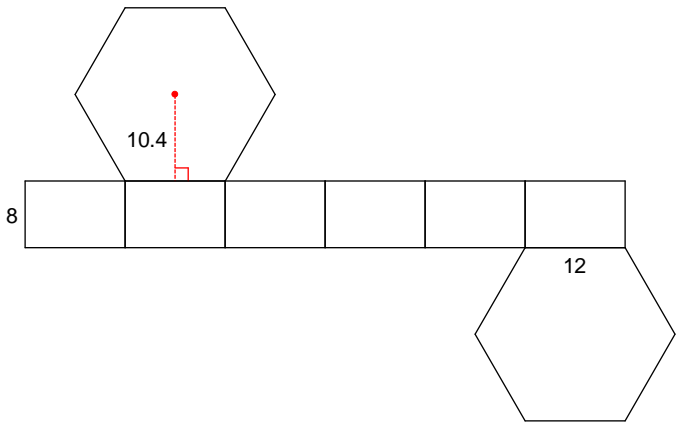

391)

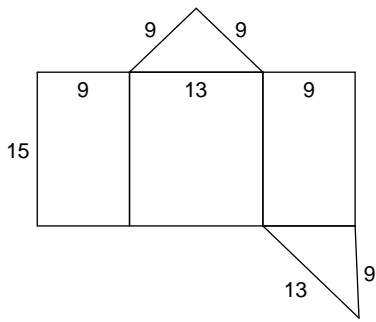

392)

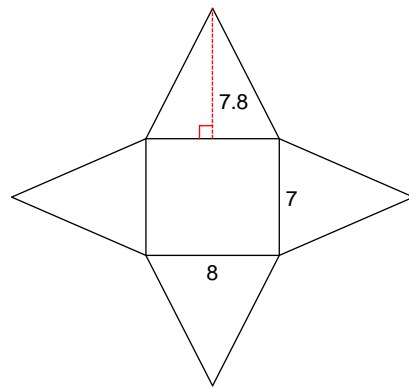

393)

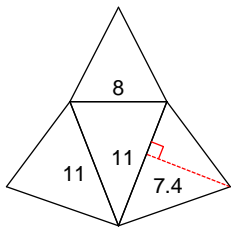

394)

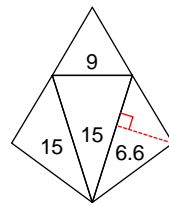

395)

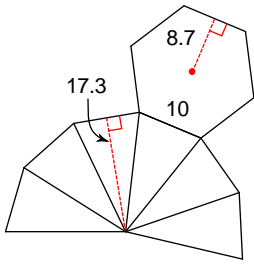

396)

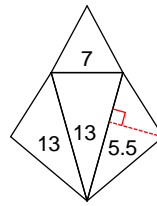

397)

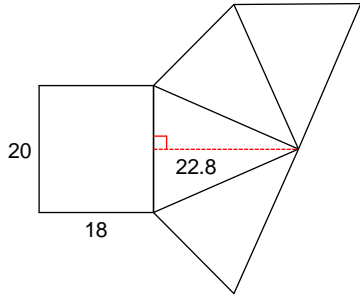

398)

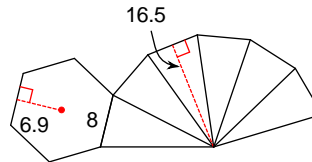

399)

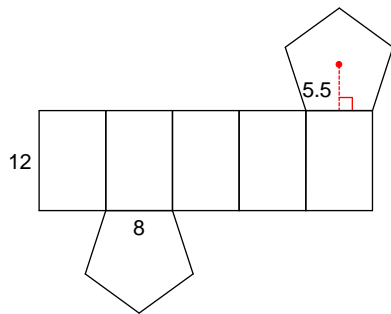

400)

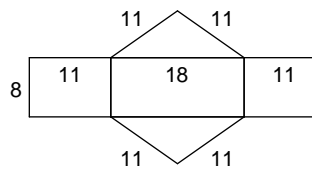

Draw a solid from drawn net

Draw a solid from given net of each prism:

1)

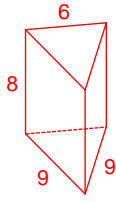
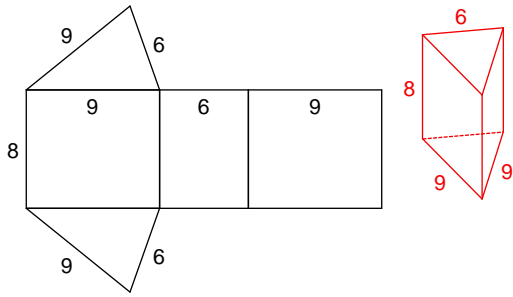

2)

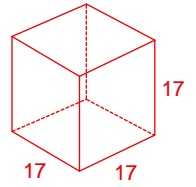
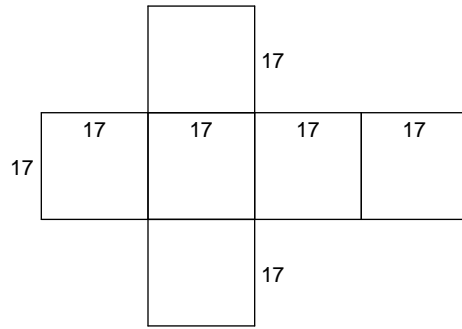

3)

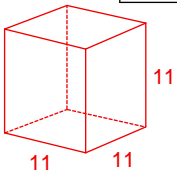
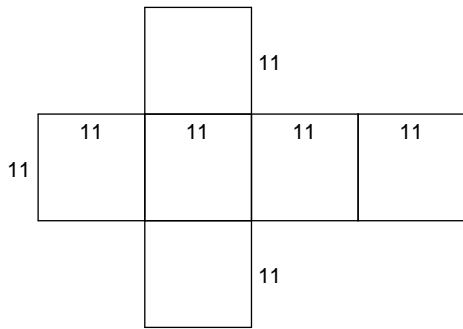

4)

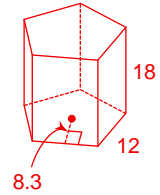
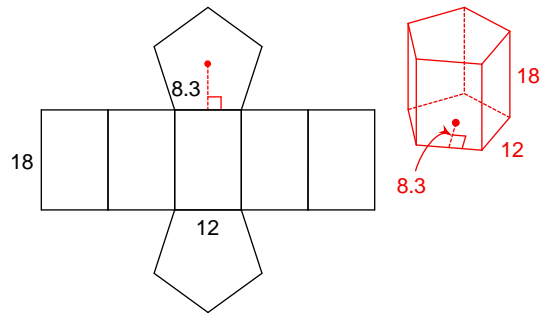

5)

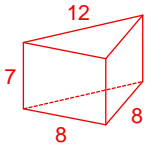
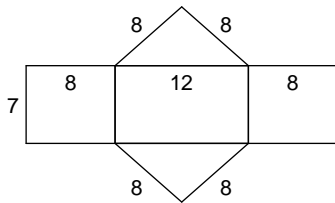

6)

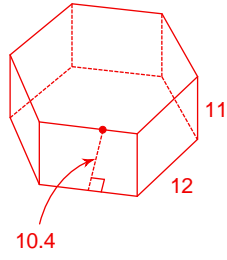
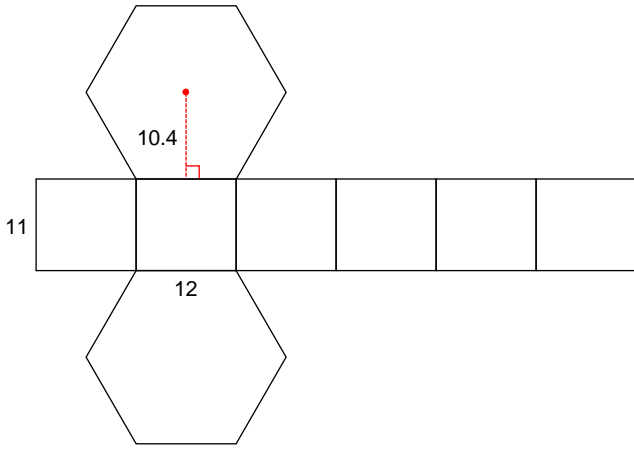

7)

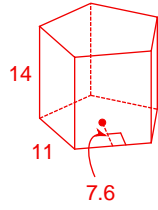
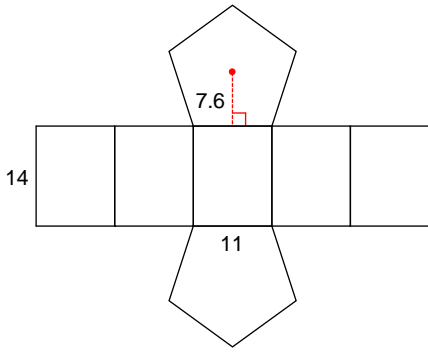

8)

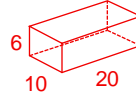
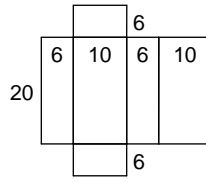

9)

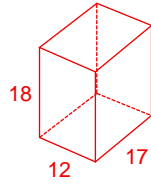
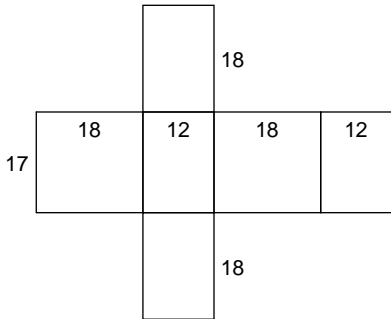

10)

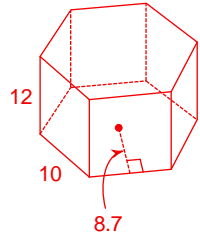
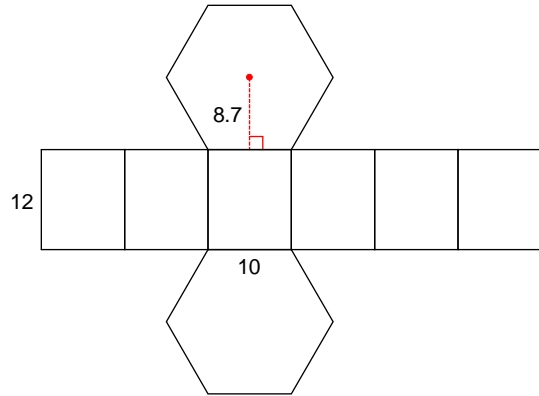

11)

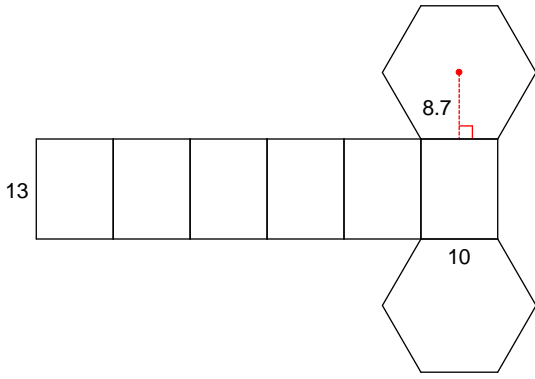

12)

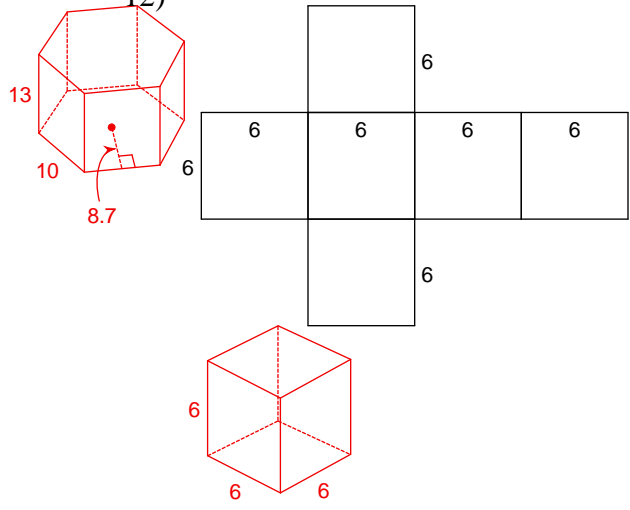

13)

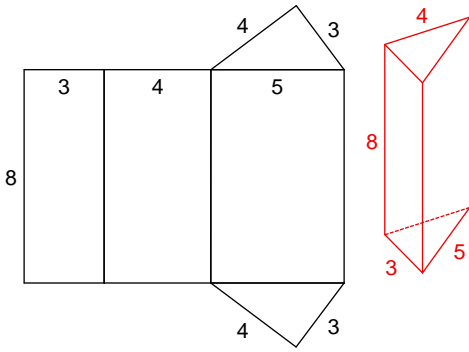

14)

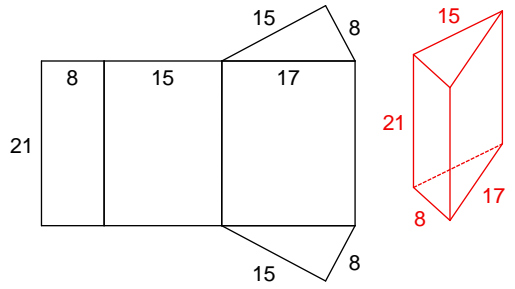

15)

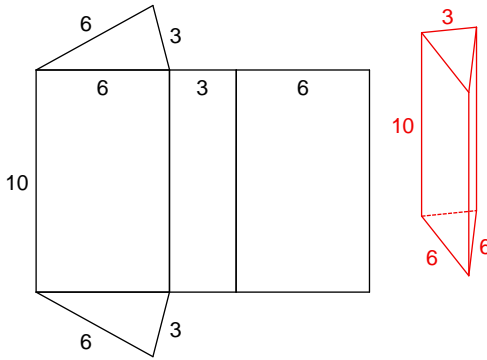

16)

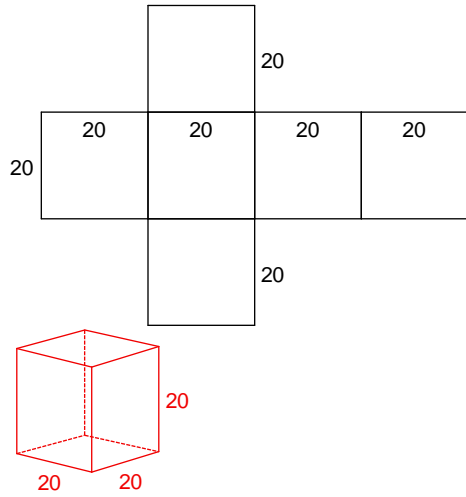

17)

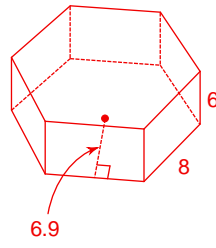
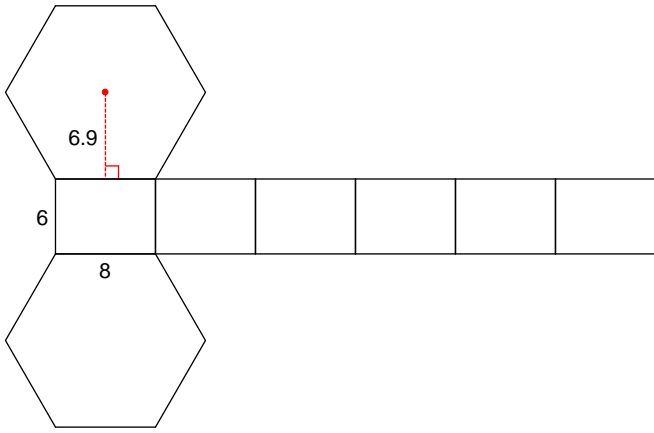

18)

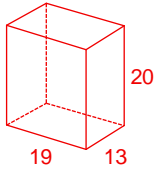
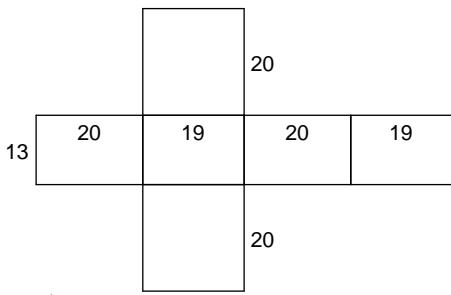

19)

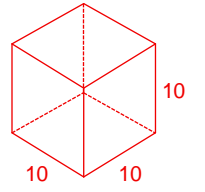
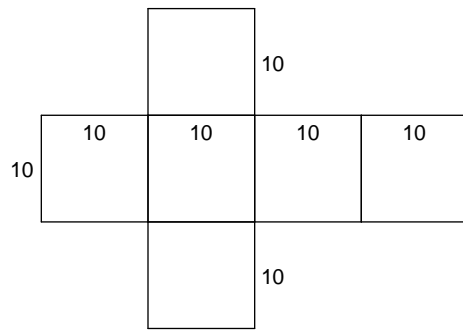

20)

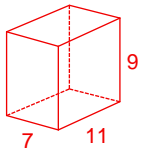
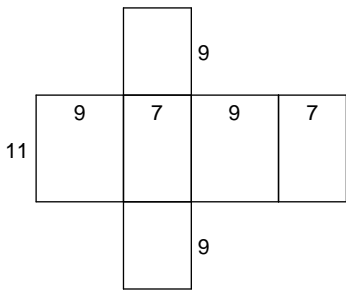

21)

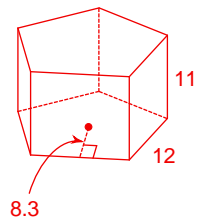
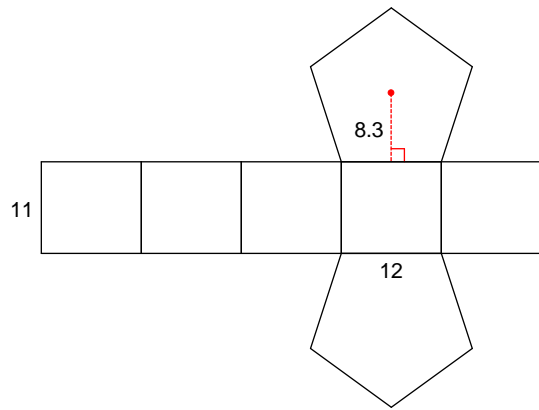

22)

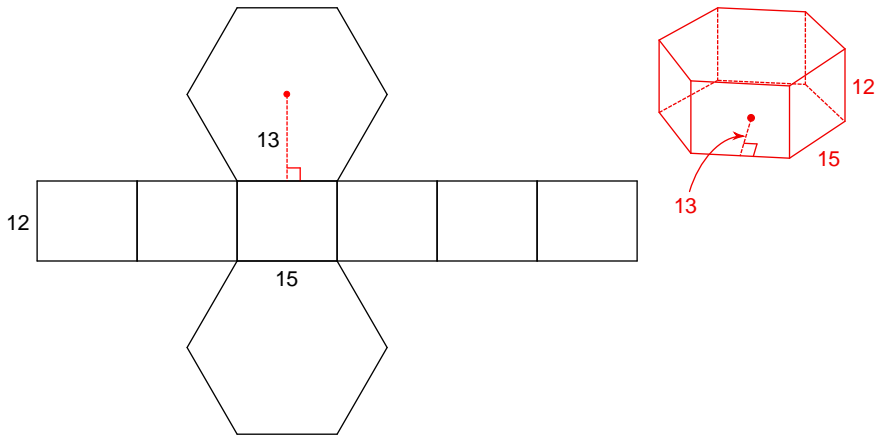

23)

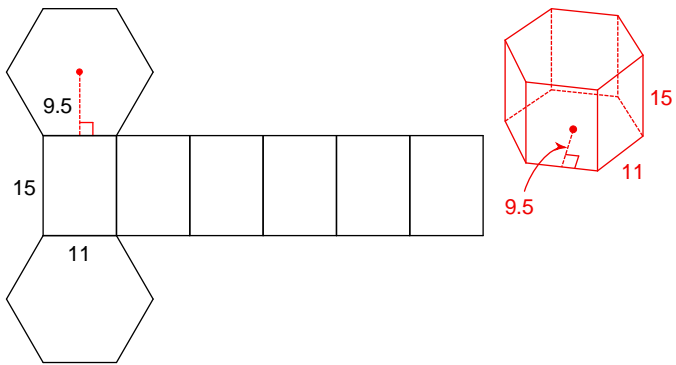

24)

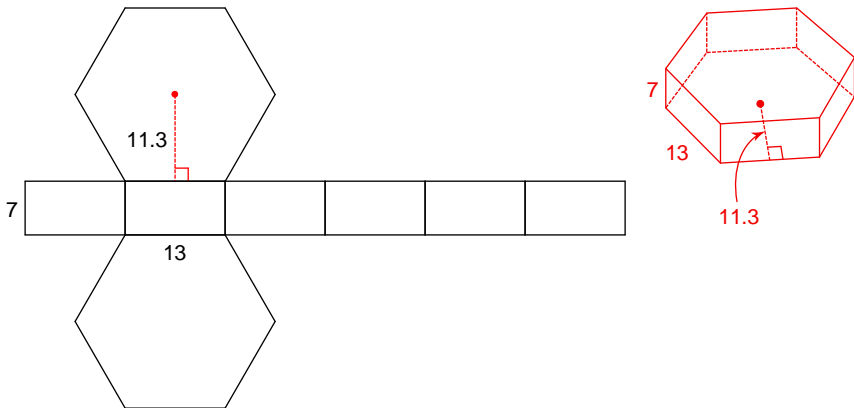

25)

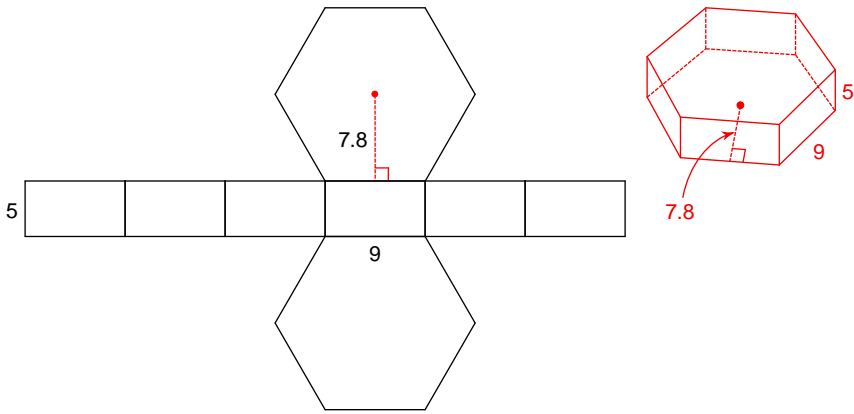

26)

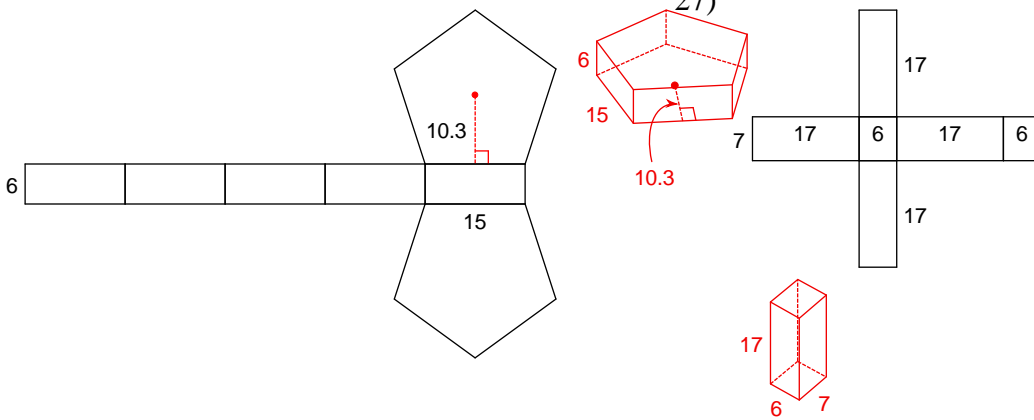

28)

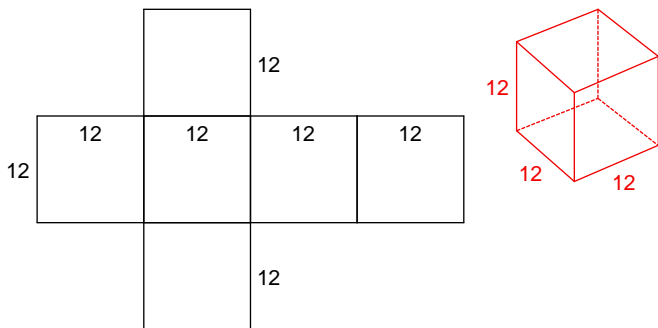

29)

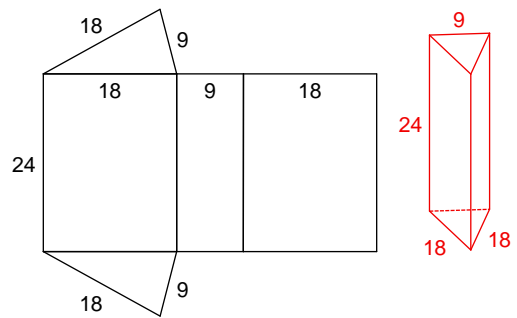

30)

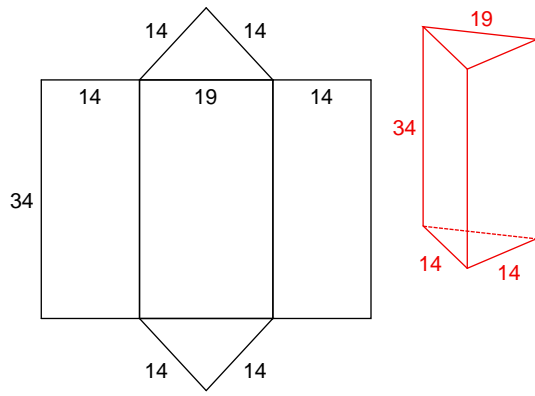

31)

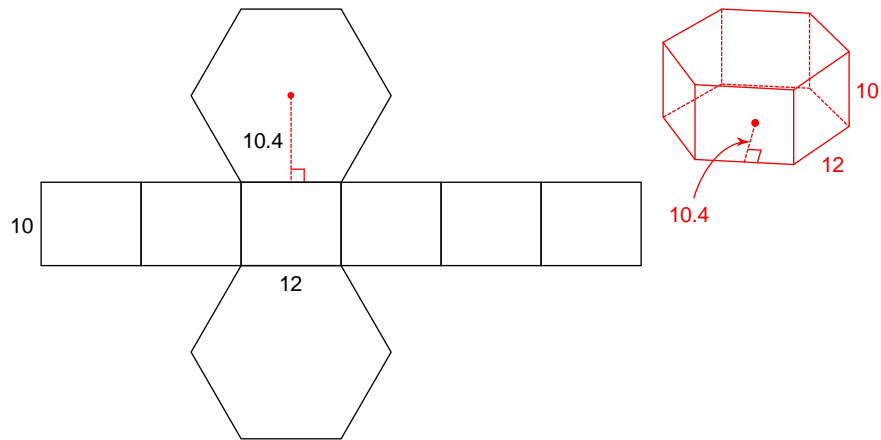

32)

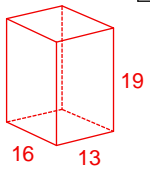
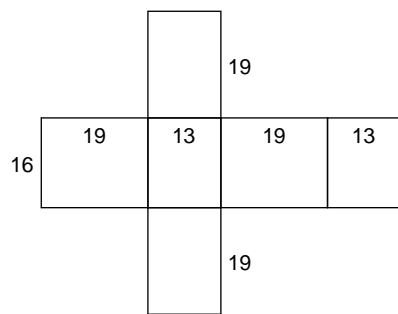

33)

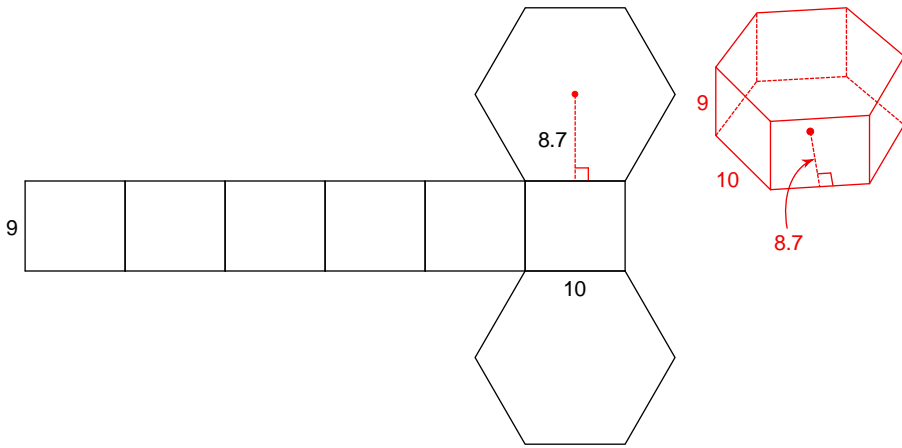

34)

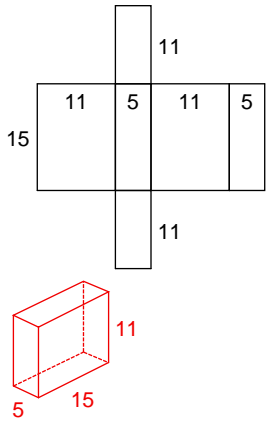

35)

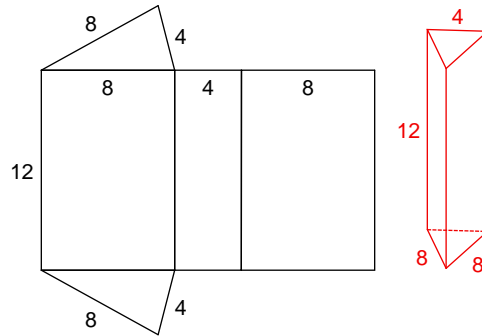

36)

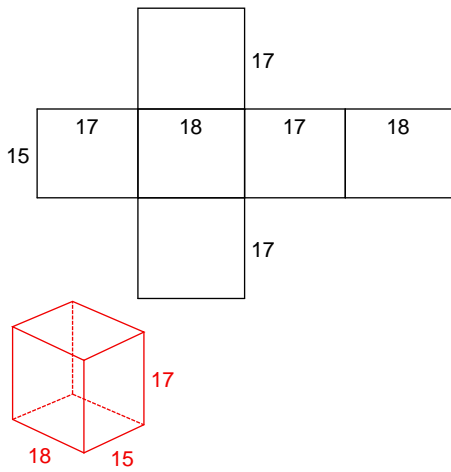

37)

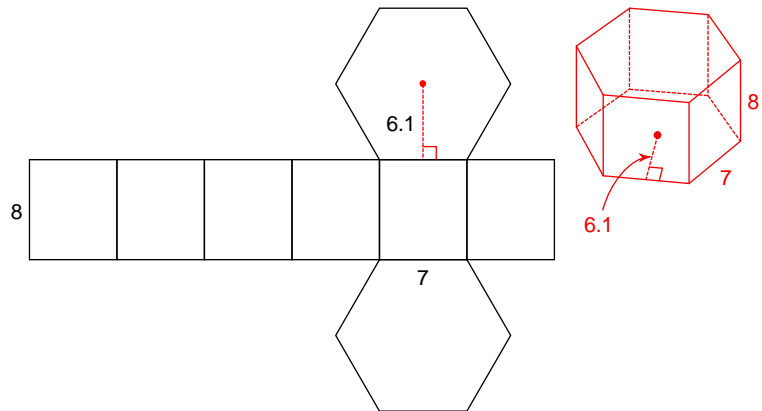

38)

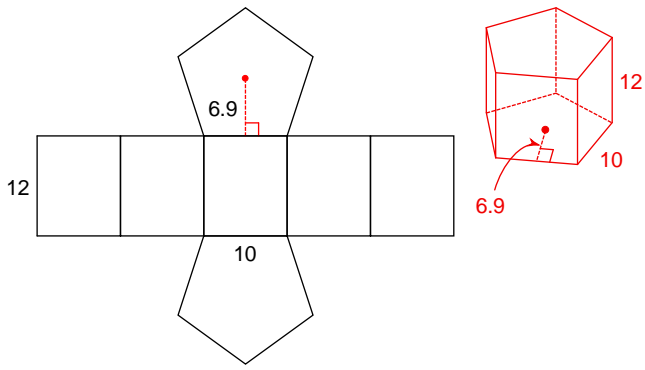

39)

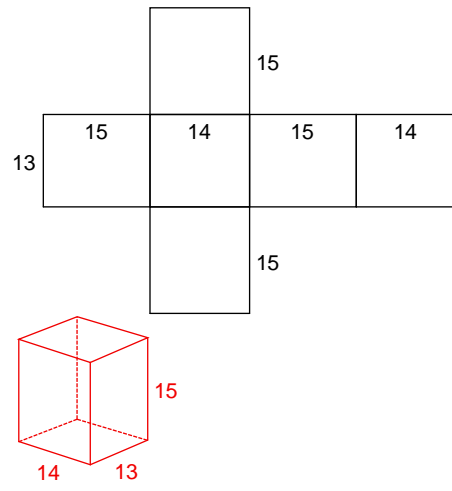

40)

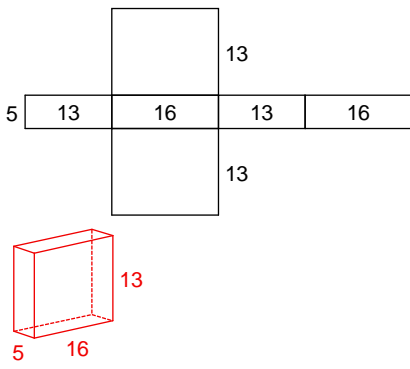

41)

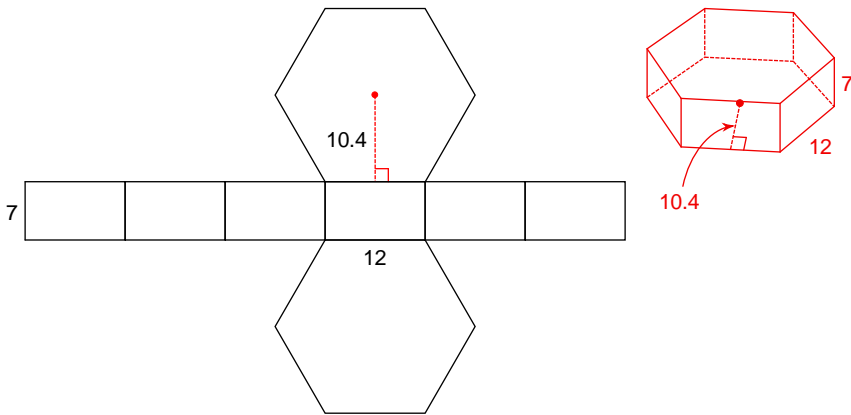

42)

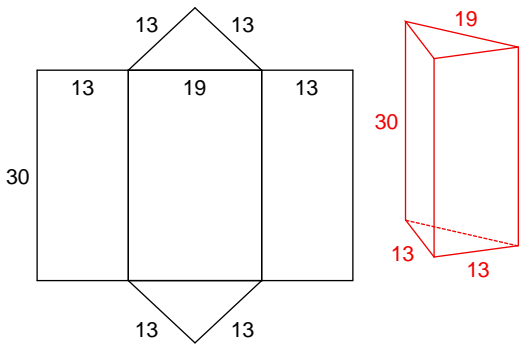

43)

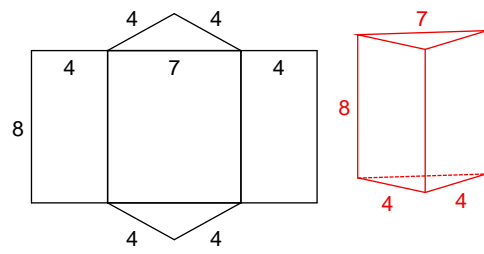

44)

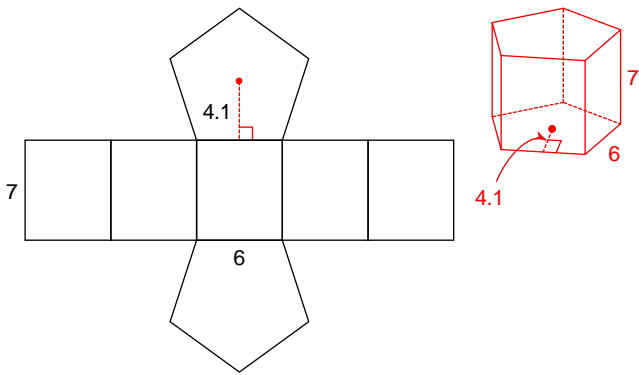

45)

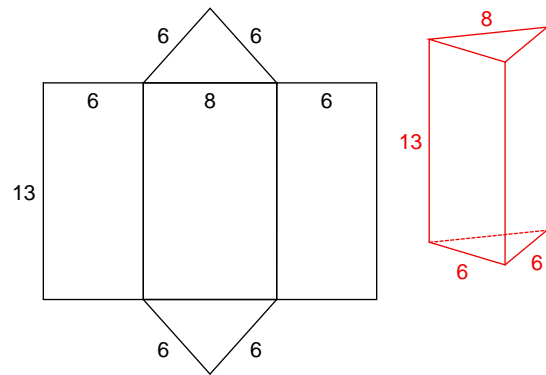

46)

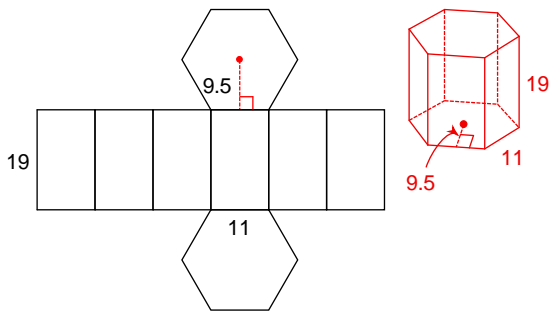

47)

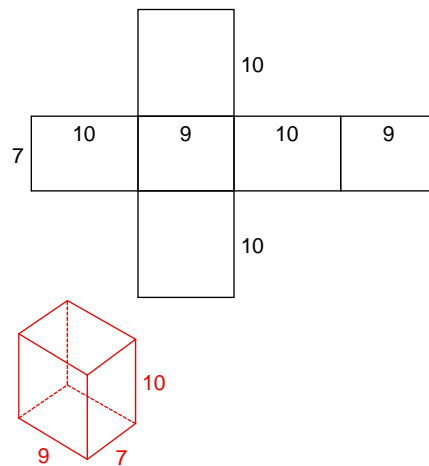

48)

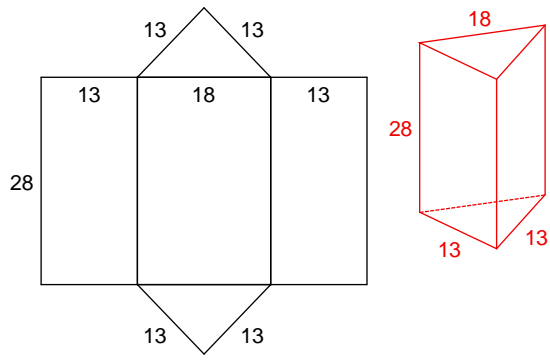

49)

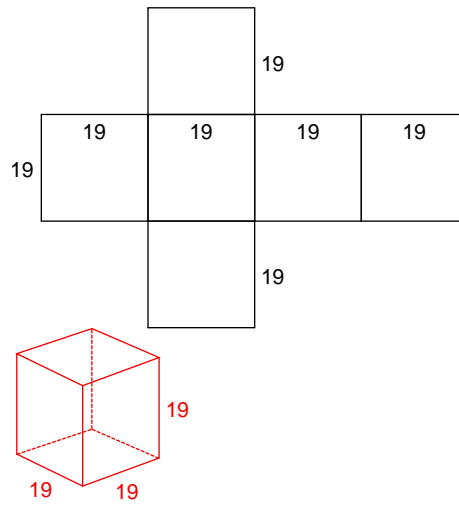

50)

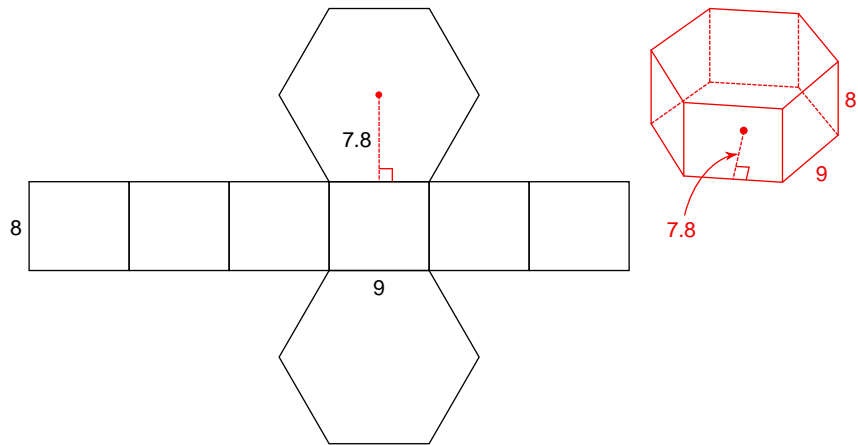

51)

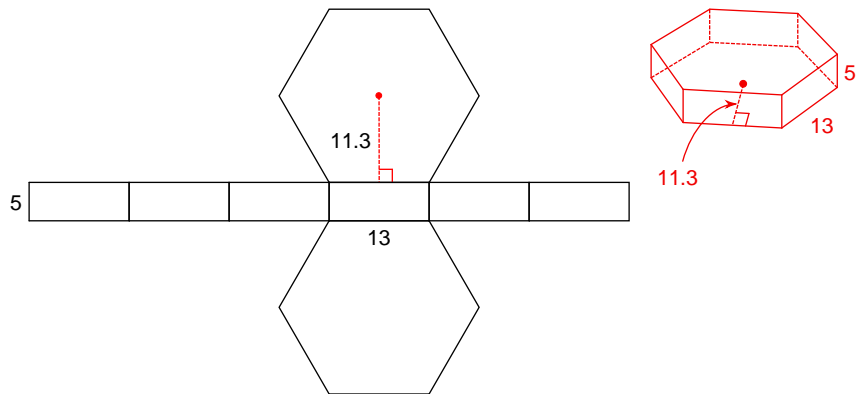

52)

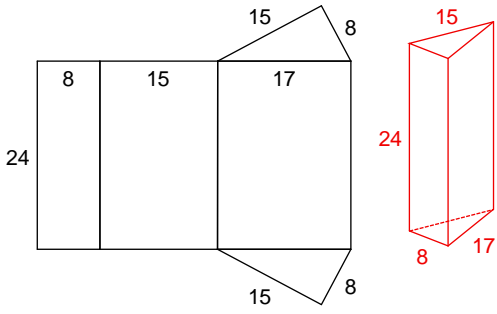

53)

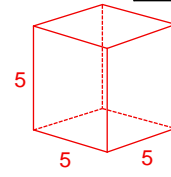
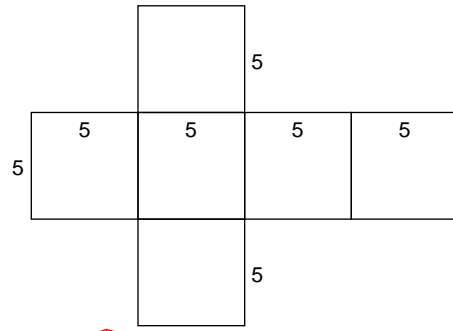

54)

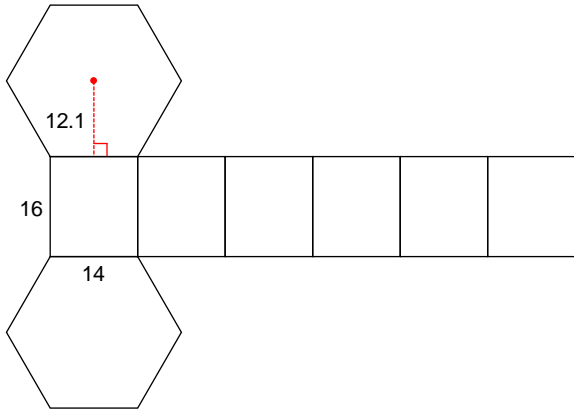

55)

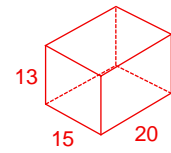
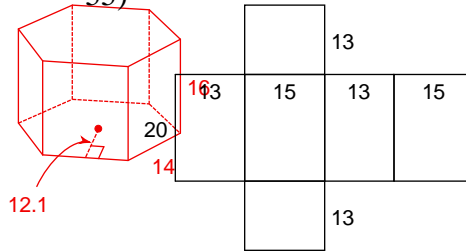

56)

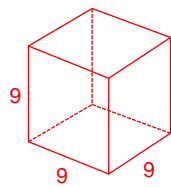
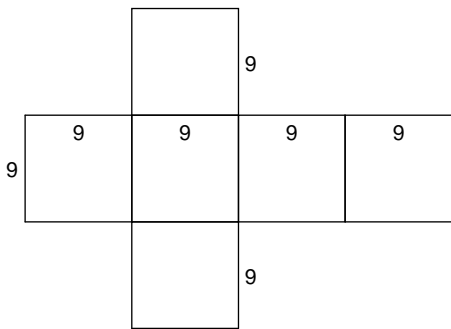

57)

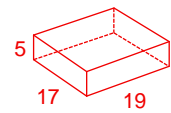
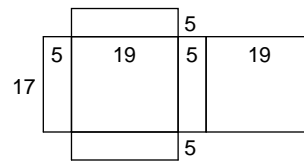

58)

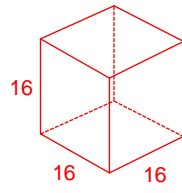
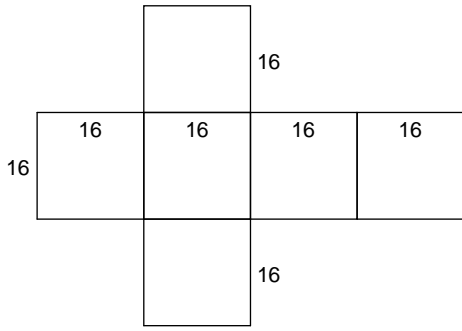

59)

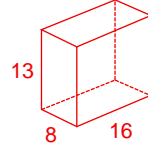
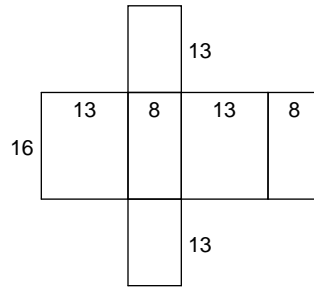

60)

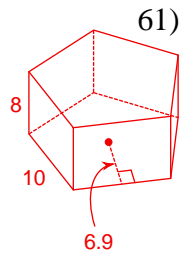
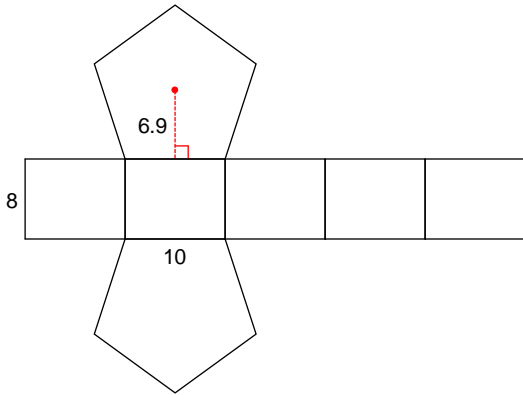

61)

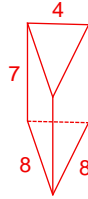
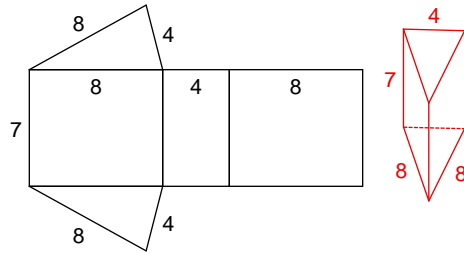

62)

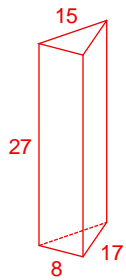
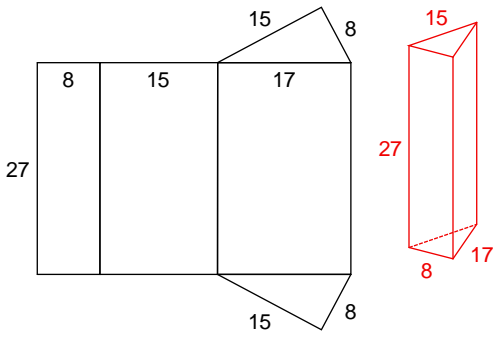

63)

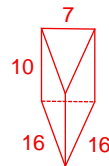
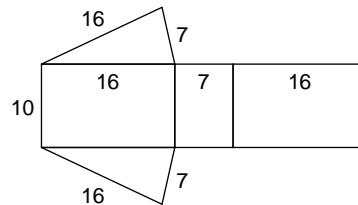

64)

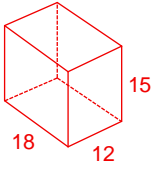
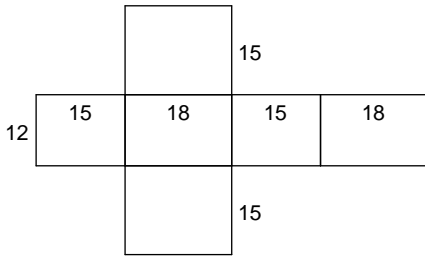

65)

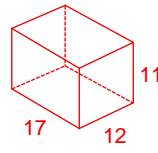
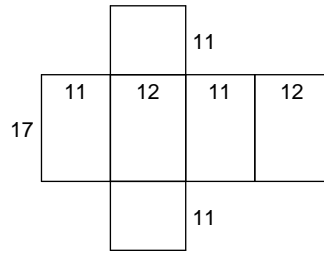

66)

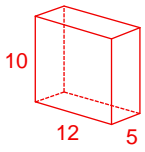
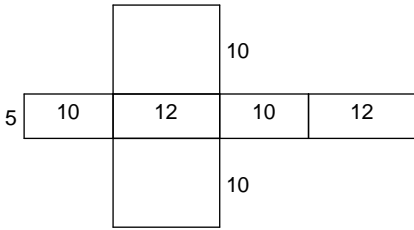

67)

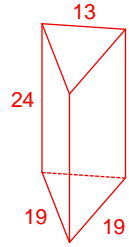
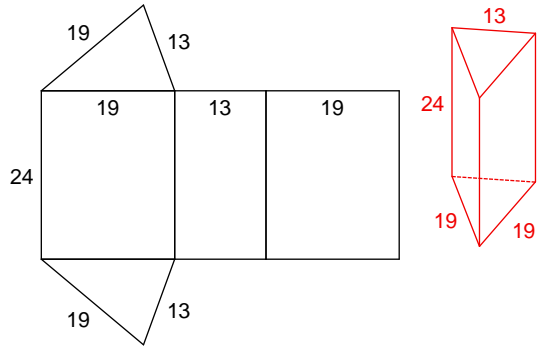

68)

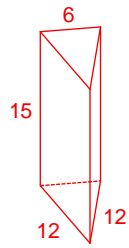
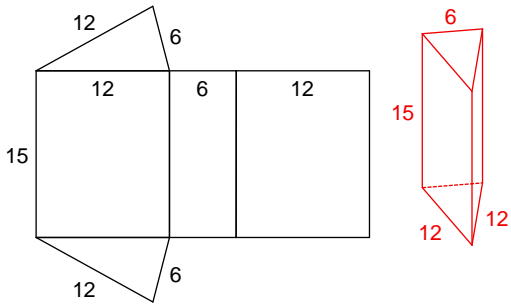

69)

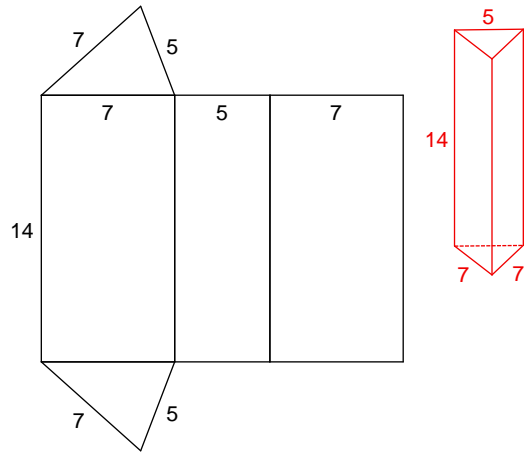

70)

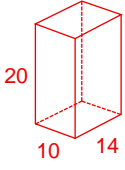
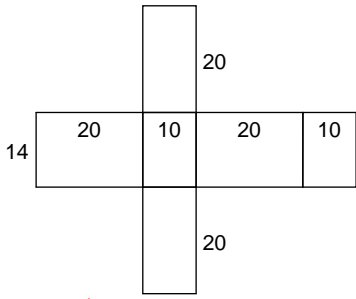

71)

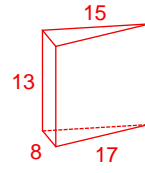
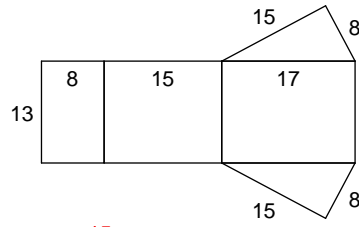

72)

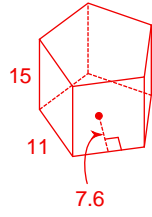
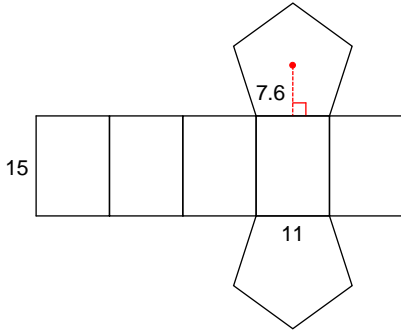

73)

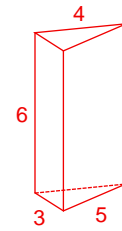
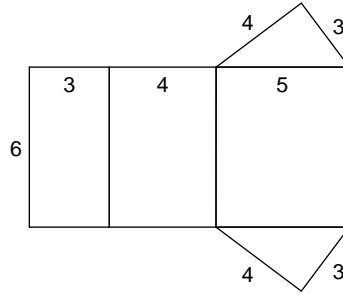

74)

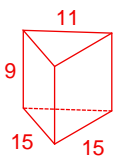
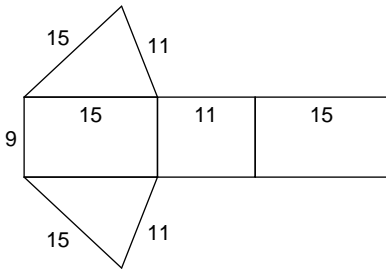

75)

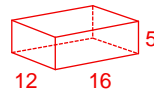
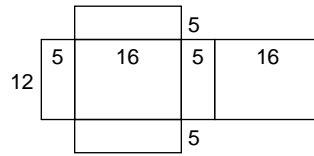

76)

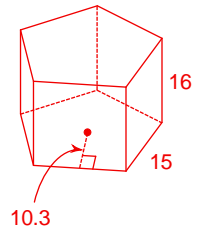
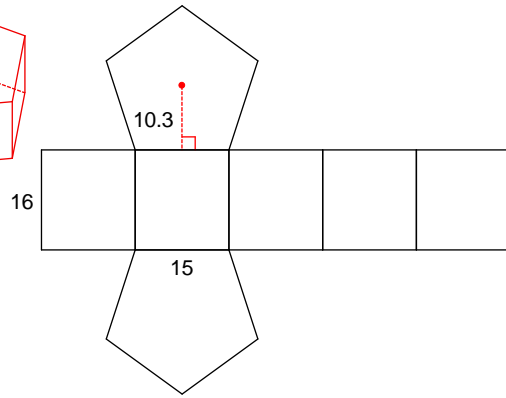
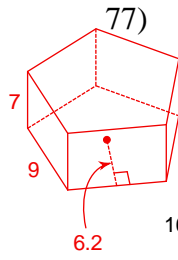
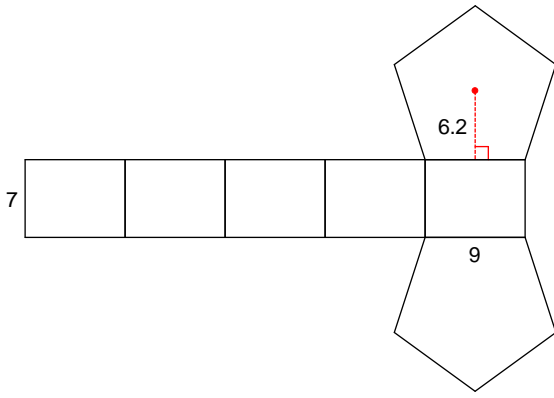

78)

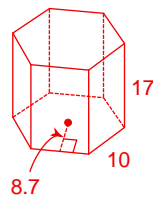
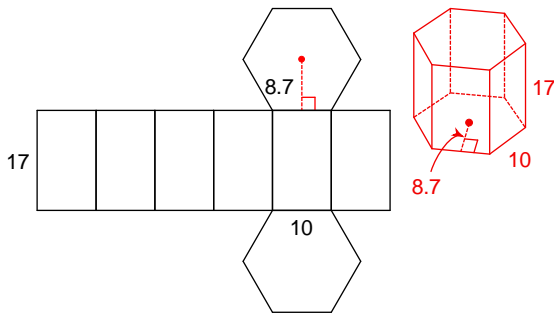

79)

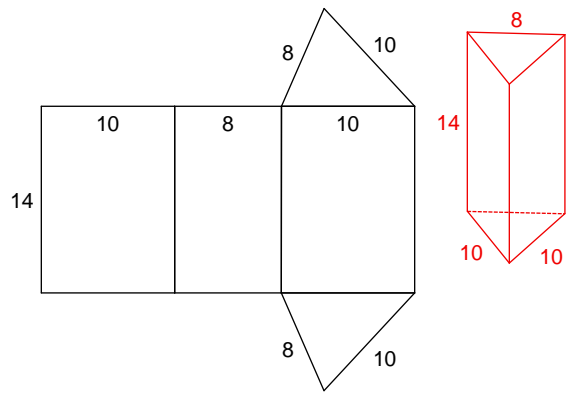

80)

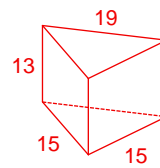
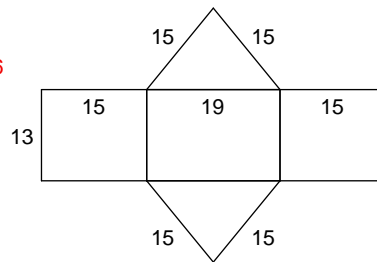
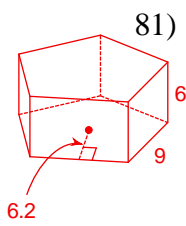
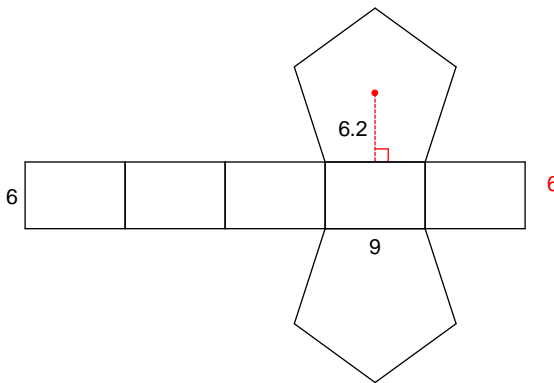

82)

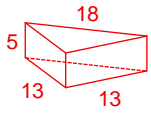
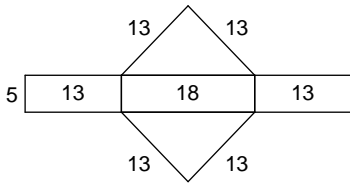

83)

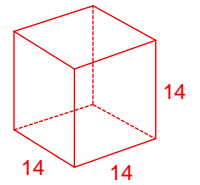
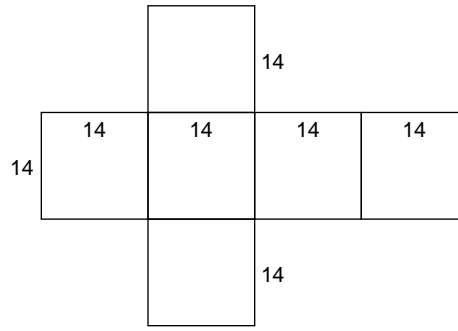

84)

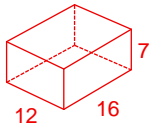
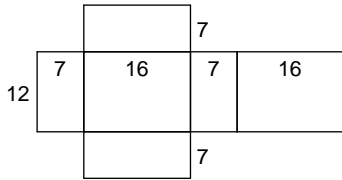

85)

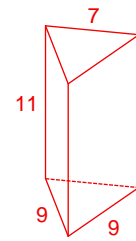
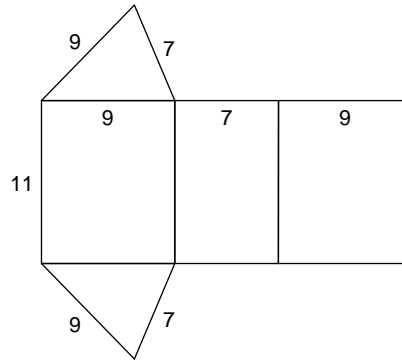

86)

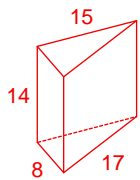
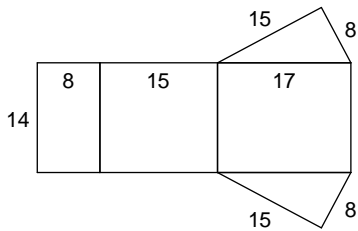

87)

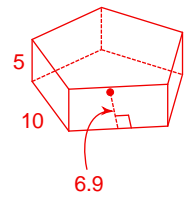
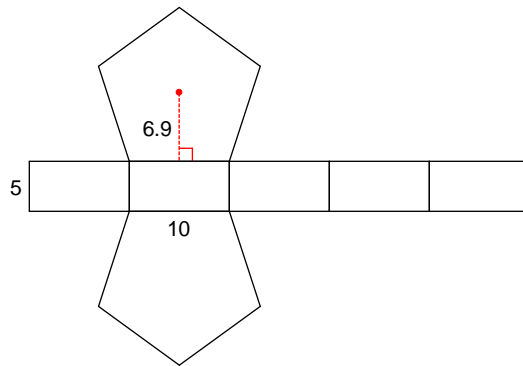

88)

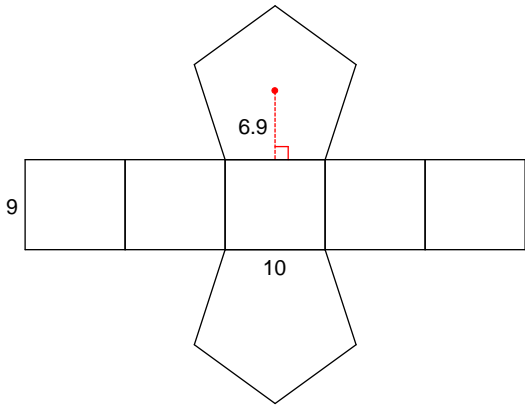

89)

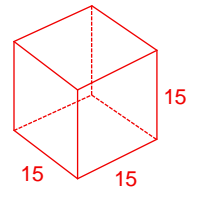
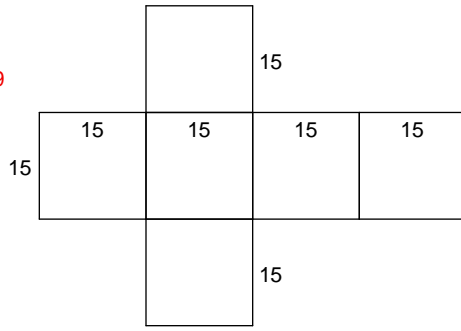
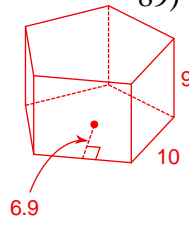

90)

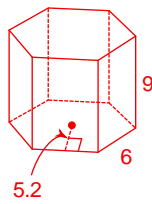
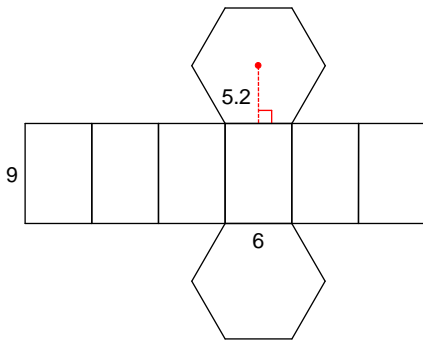

91)

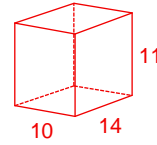
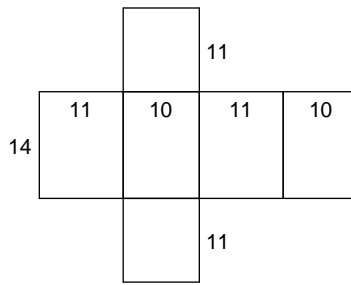

92)

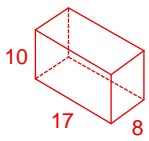
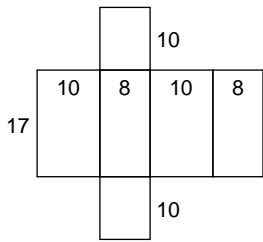

93)

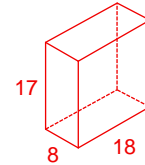
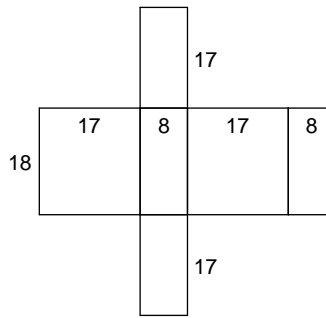

94)

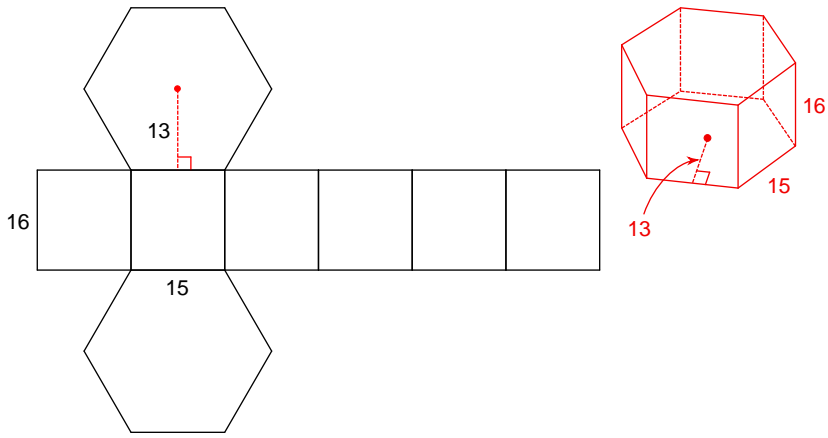

95)

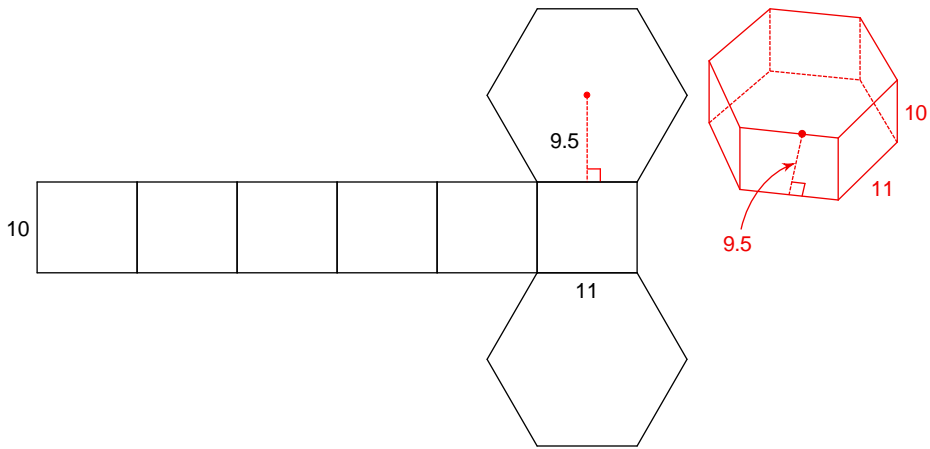

96)

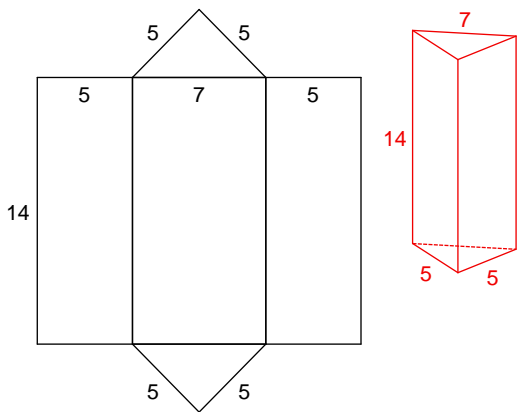

97)

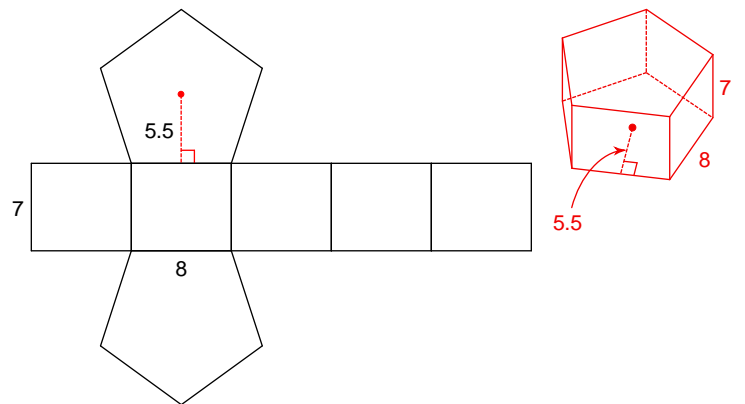

98)

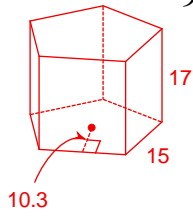
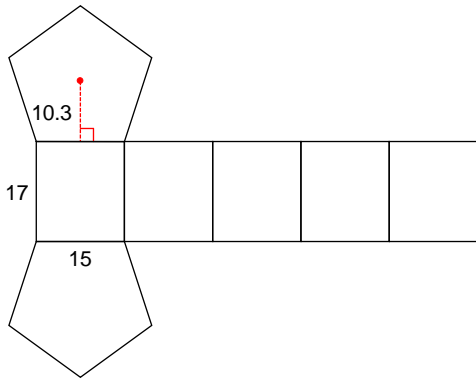

99)

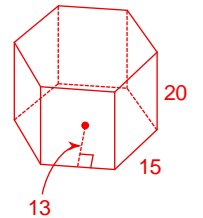
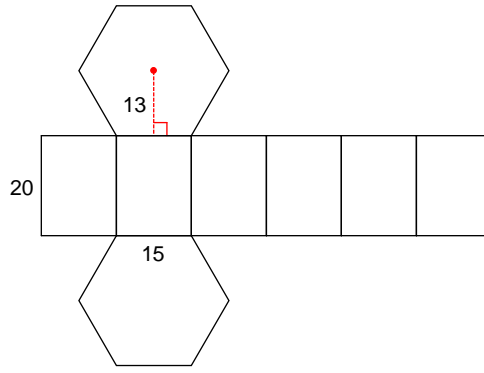

100)

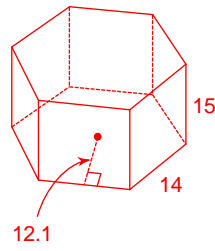
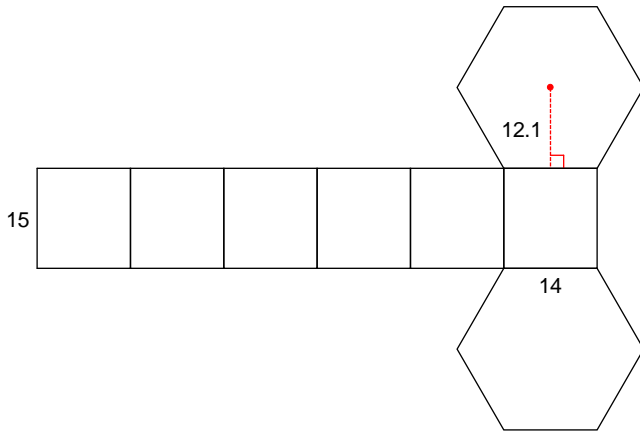

Draw a solid from given net of each pyramid:

101)

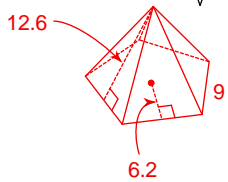
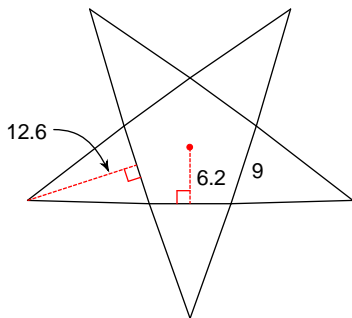

102)

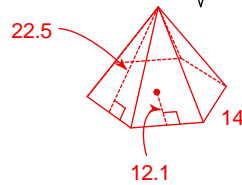
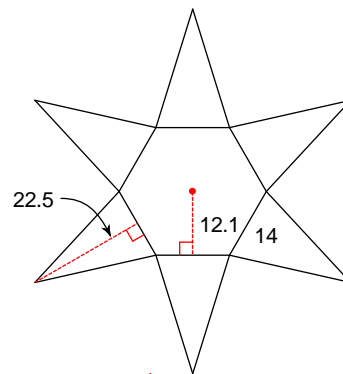

103)

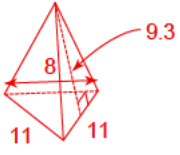
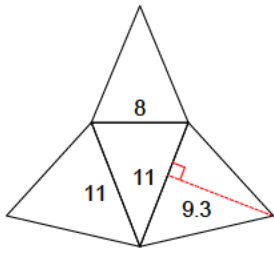

104)

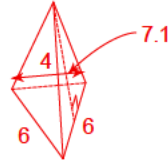
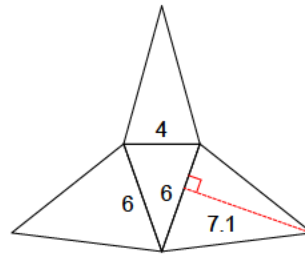

105)

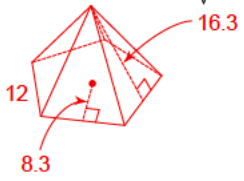
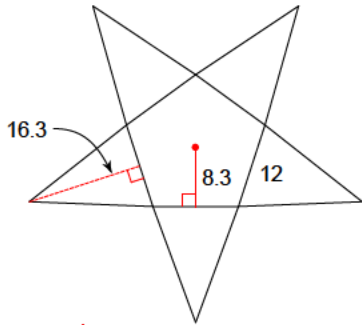

106)

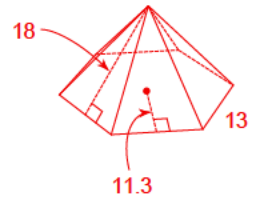
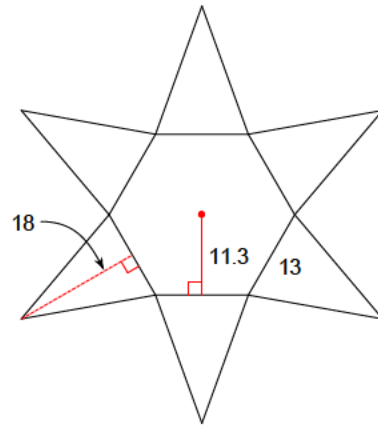

107)

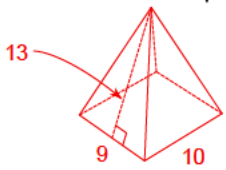
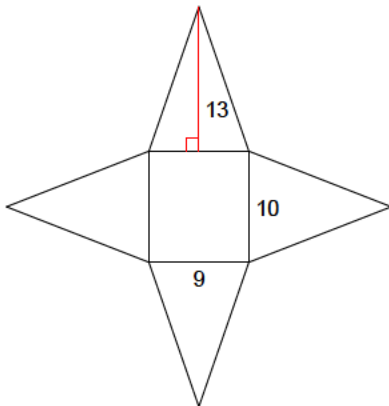

108)

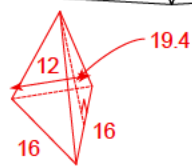
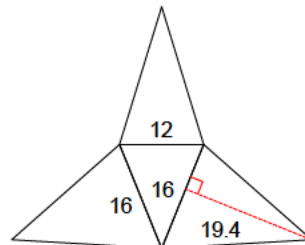

109)

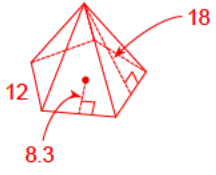
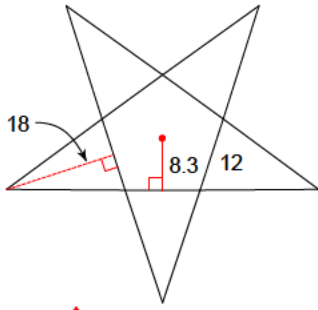

110)

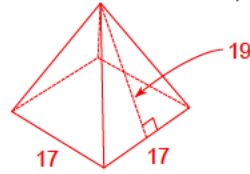
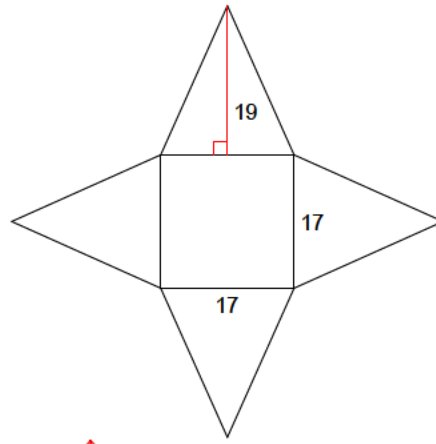

111)

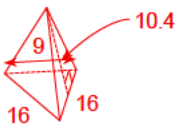
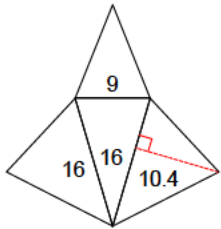

112)

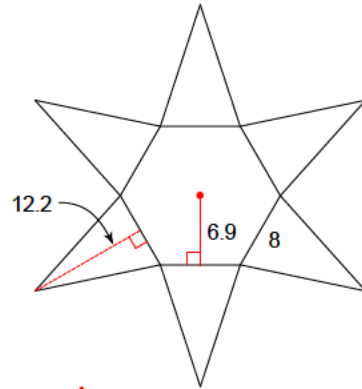

113)

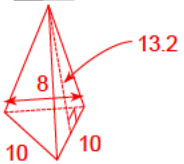
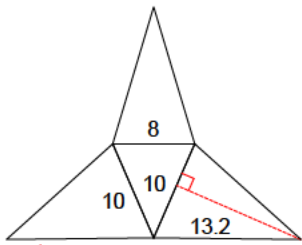

114)

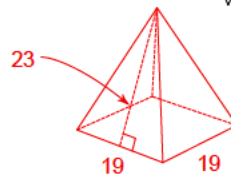
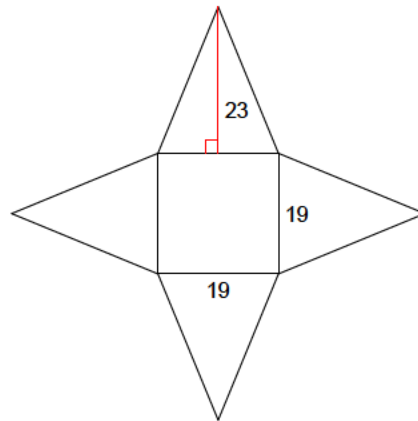

115)

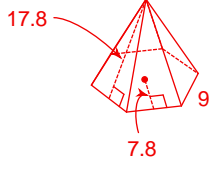
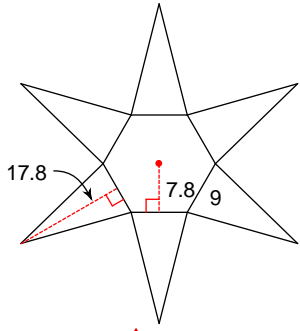

116)

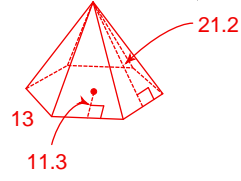
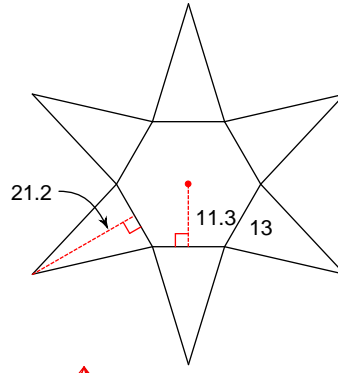

117)

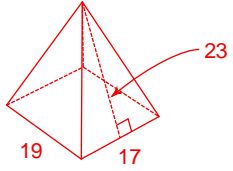
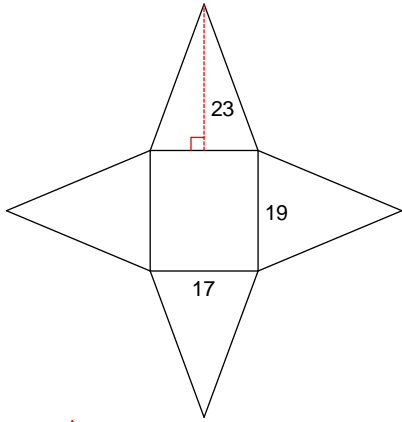

118)

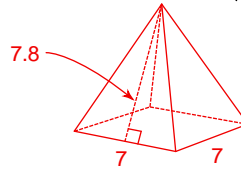
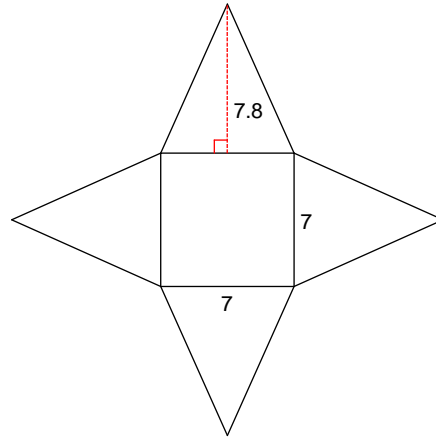

119)

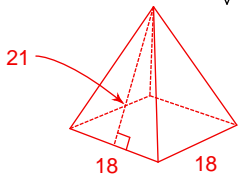
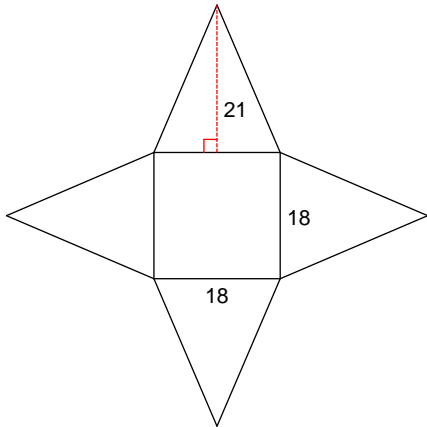

120)

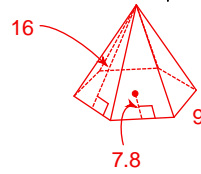
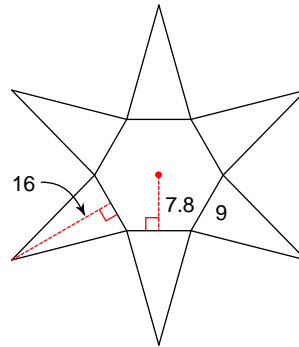

121)

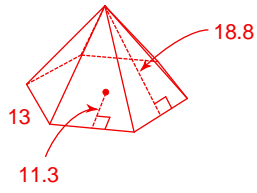
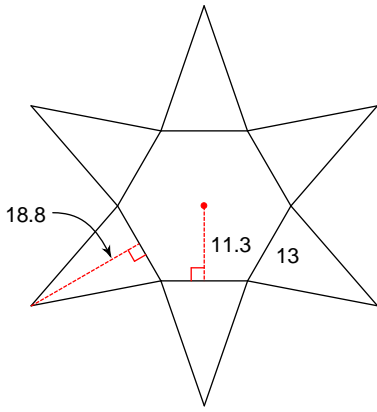

122)

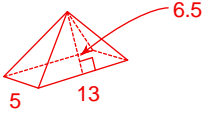
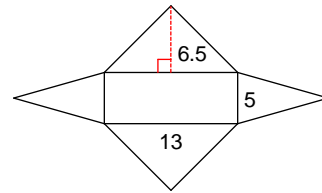

123)

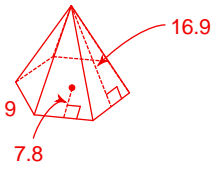
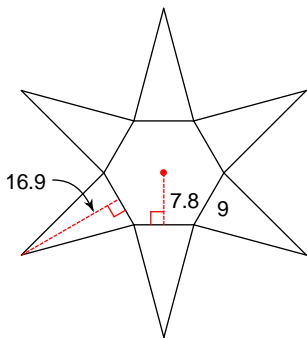

124)

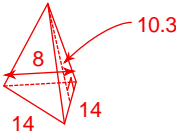
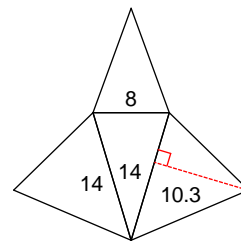

125)

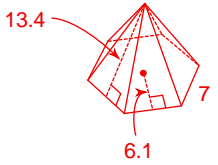
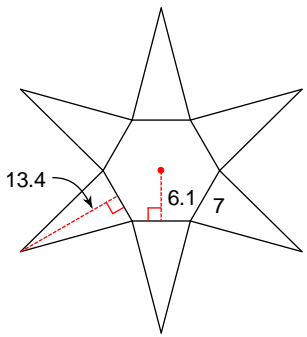

126)

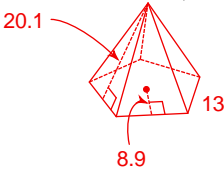
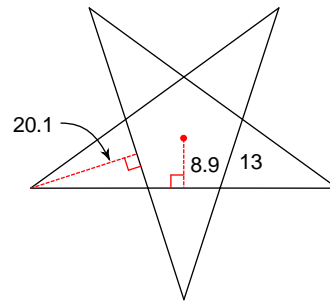

127)

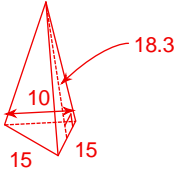
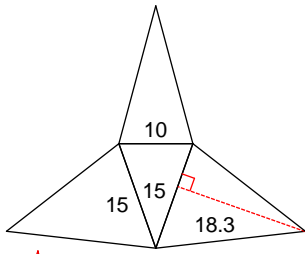

128)

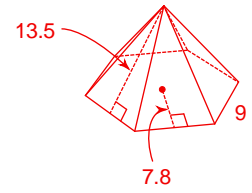
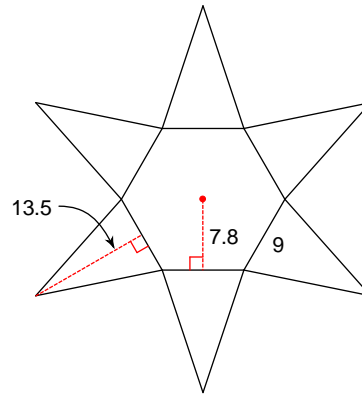

129)

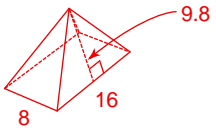
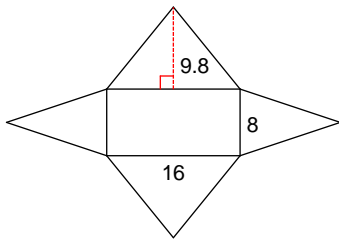

130)

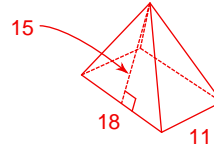
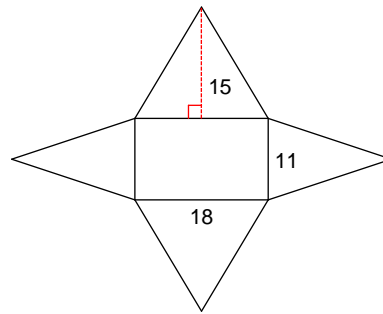

131)

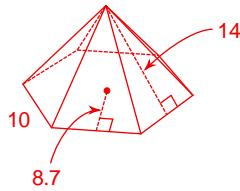
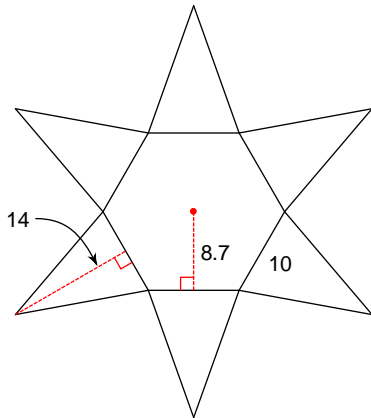

132)

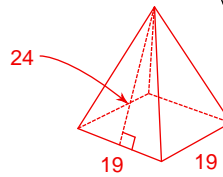
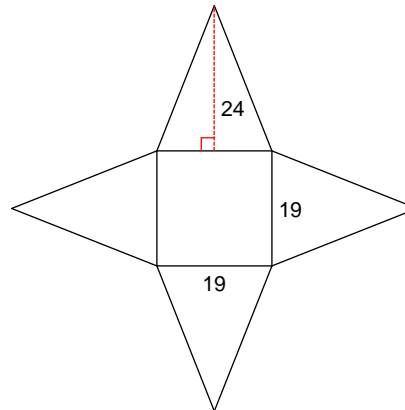

133)

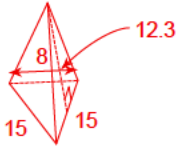
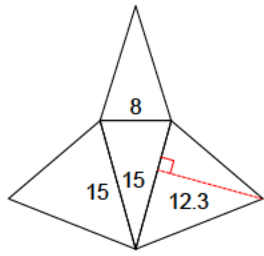

134)

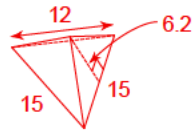
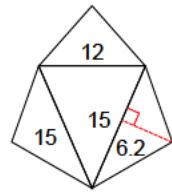

135)

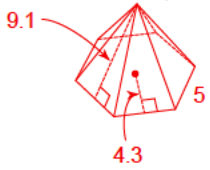
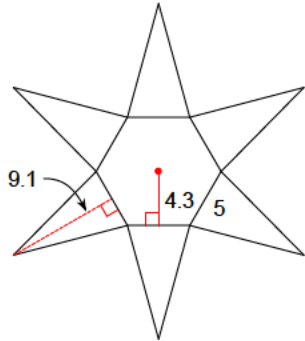

136)

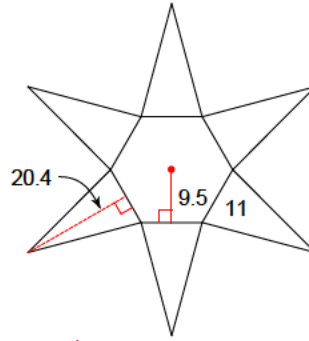

137)

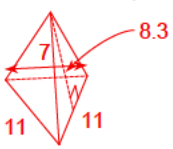
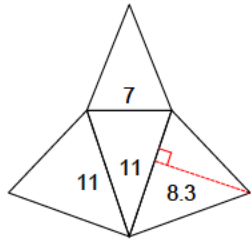

138)

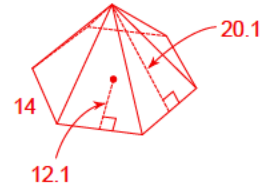
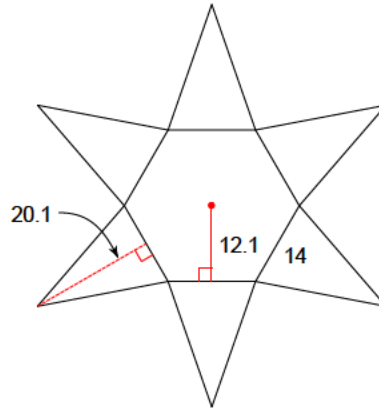

139)

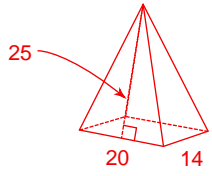
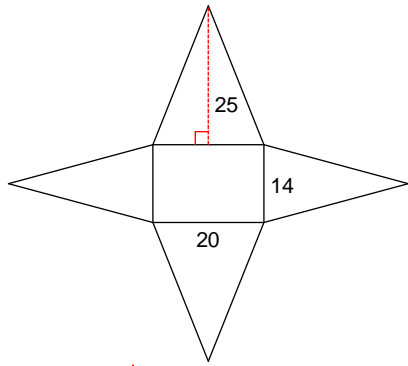

140)

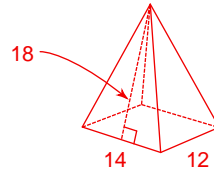
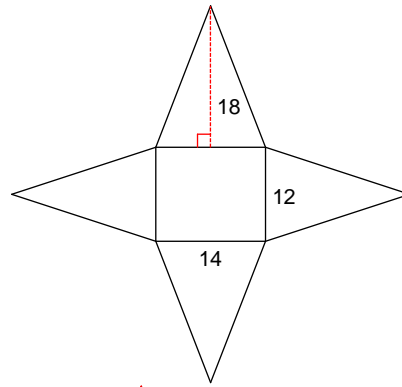

141)

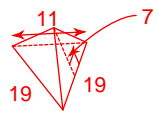
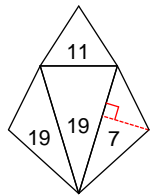

142)

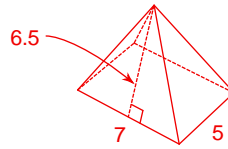
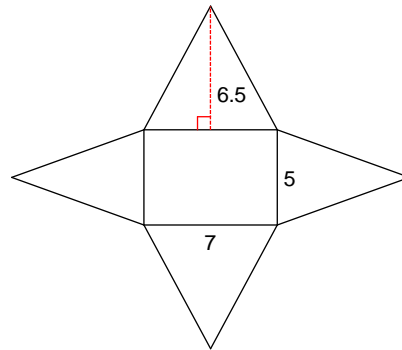

143)

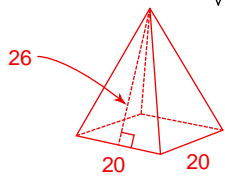
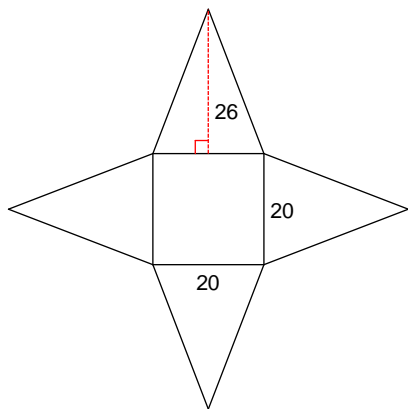

144)

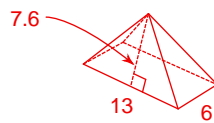
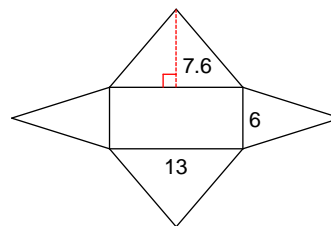

145)

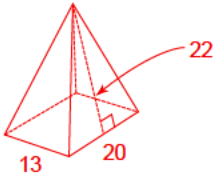
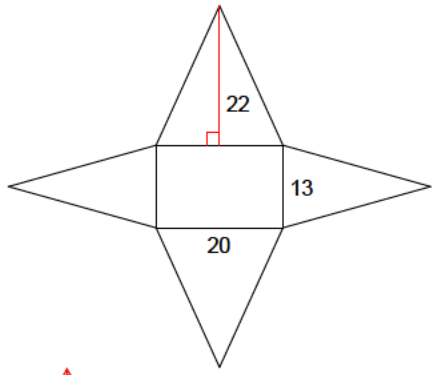

146)

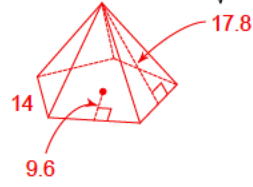
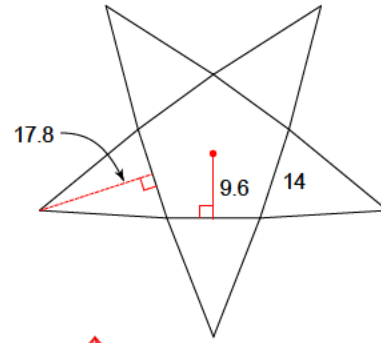

147)

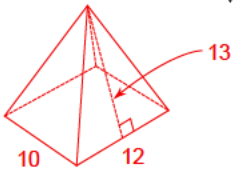
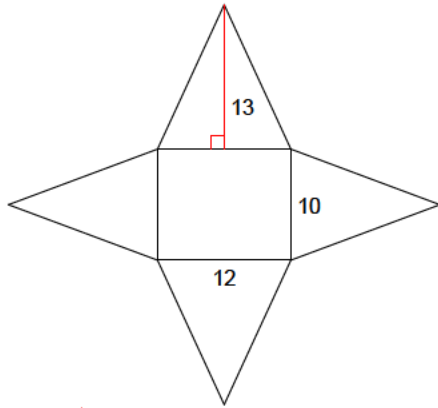

148)

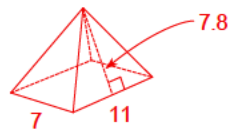
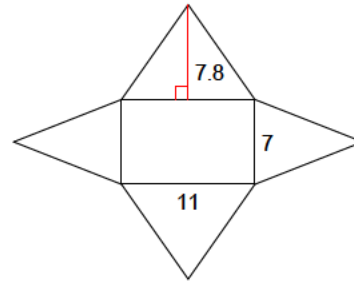

149)

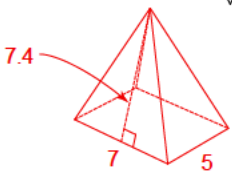
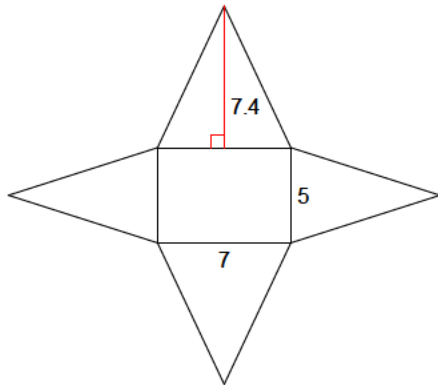

150)

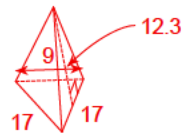
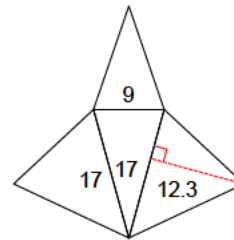

151)

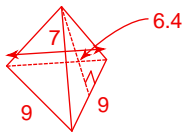
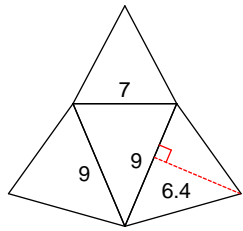

152)

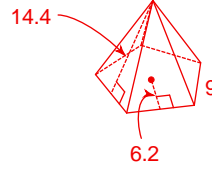
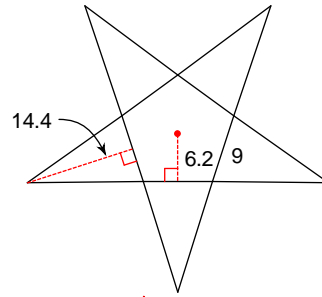

153)

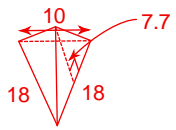
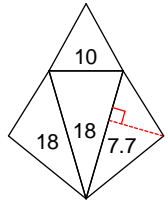

154)

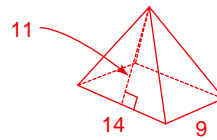
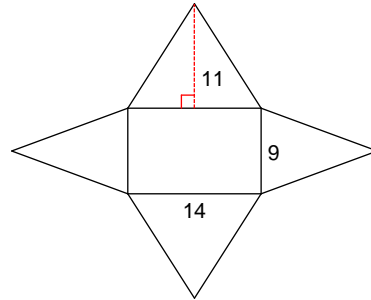

155)

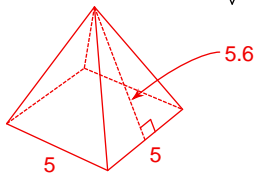
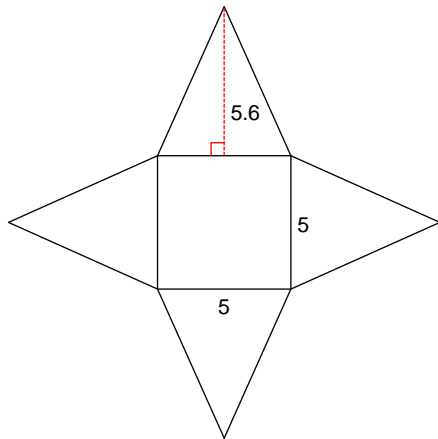

156)

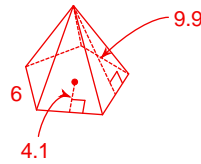
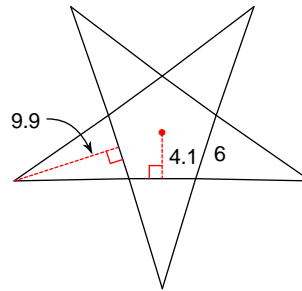

157)

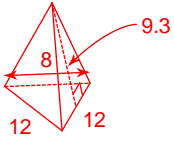
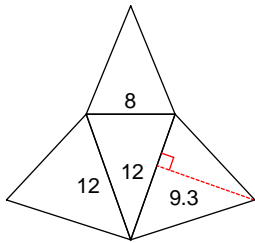

158)

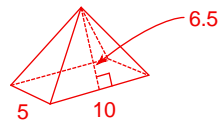
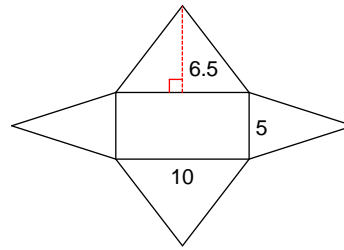

159)

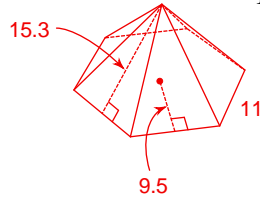
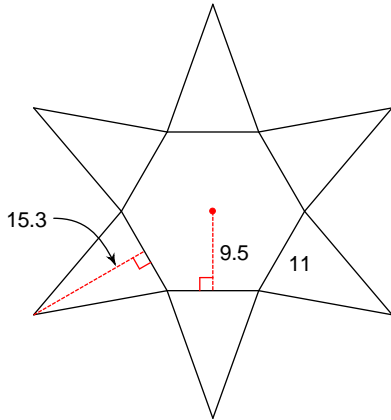

160)

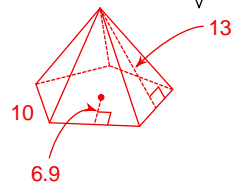
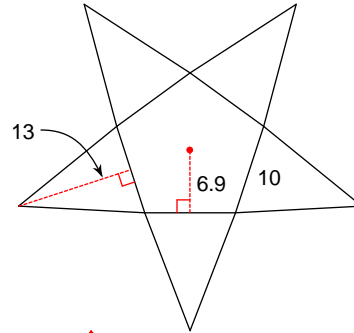

161)

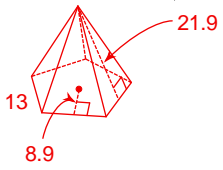
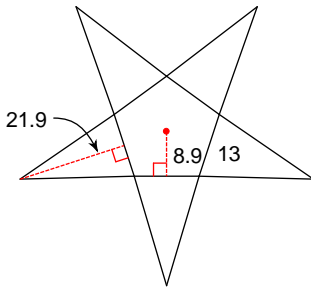

162)

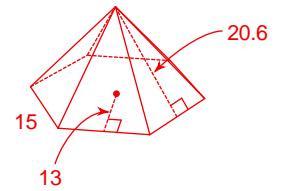
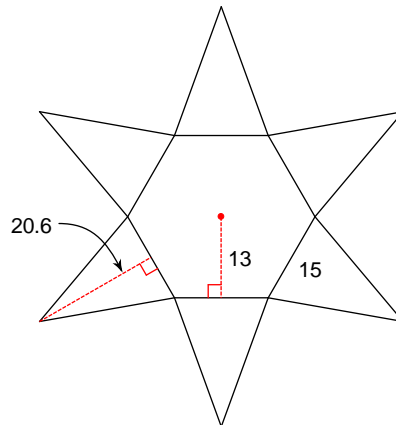

163)

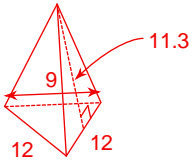
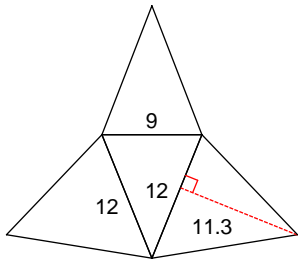

164)

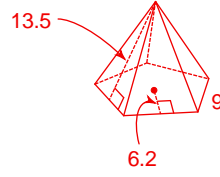
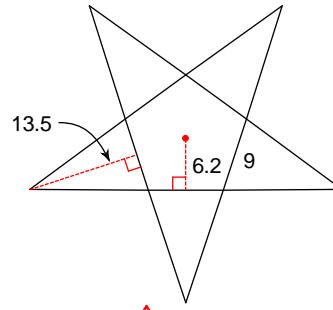

165)

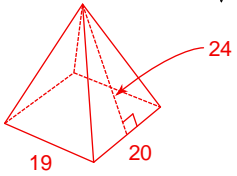
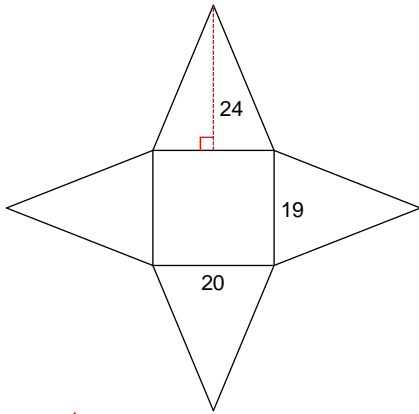

166)

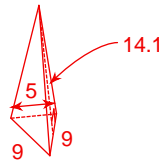
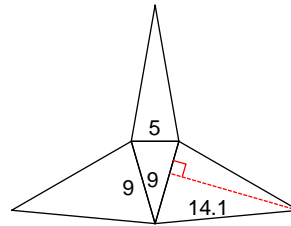

167)

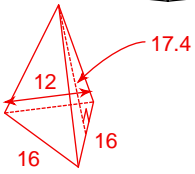
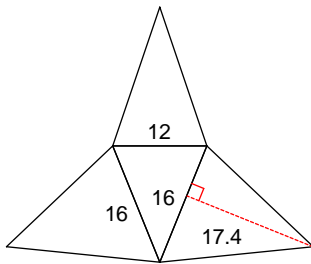

168)

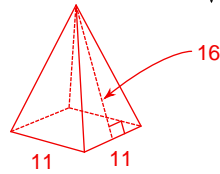
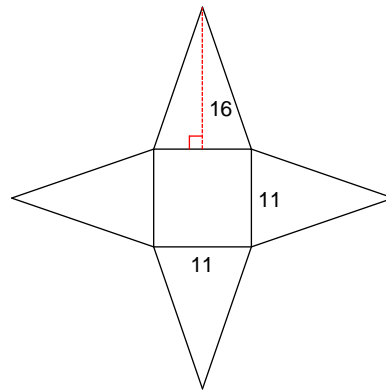

169)

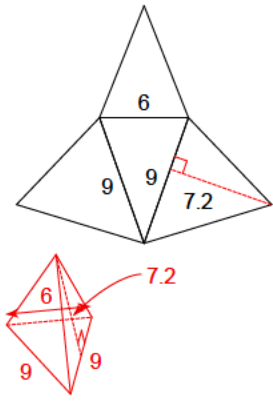

170)

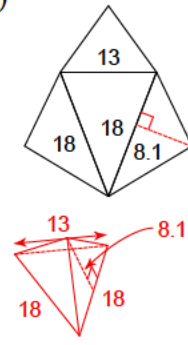

171)

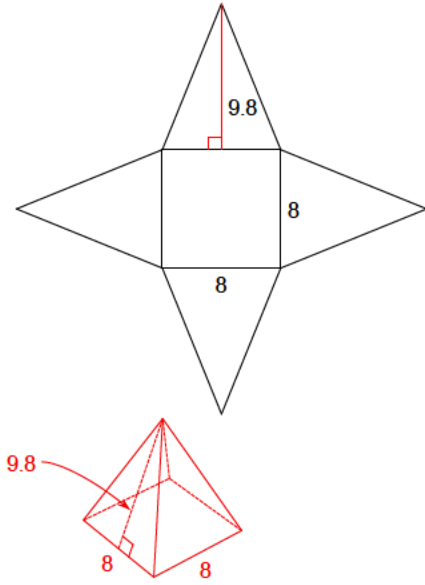

172)

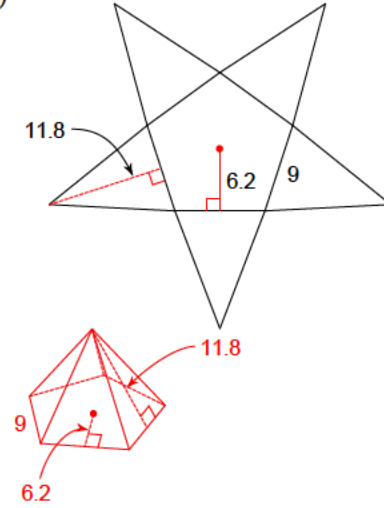

173)

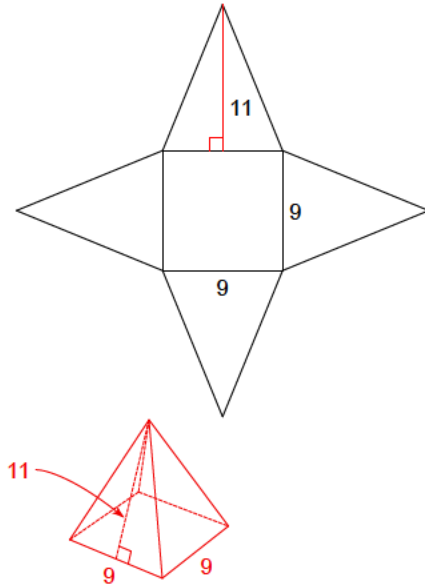

174)

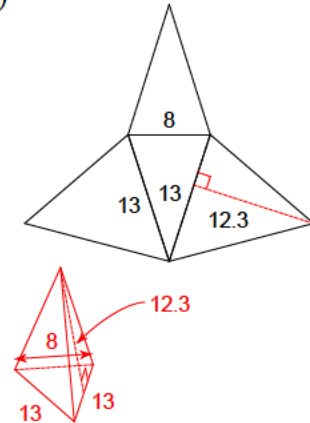

175)

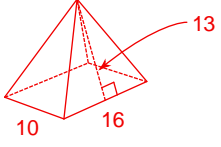
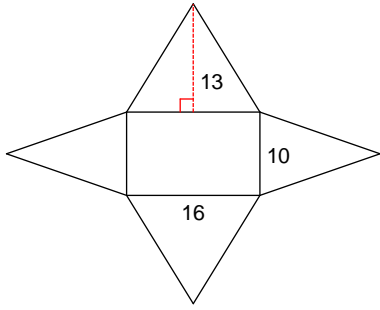

176)

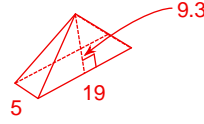
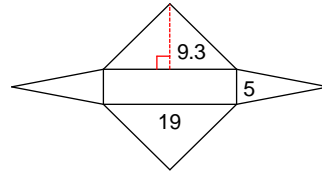

177)

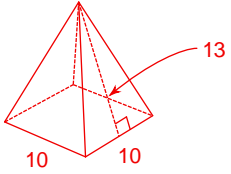
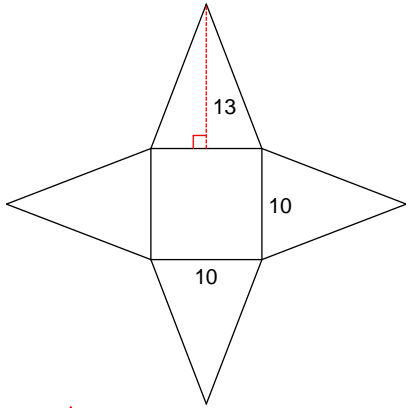

178)

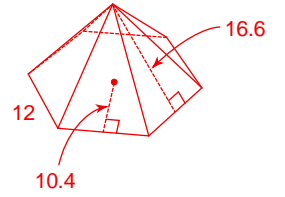
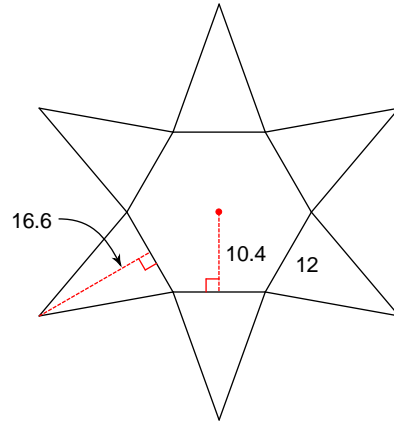

179)

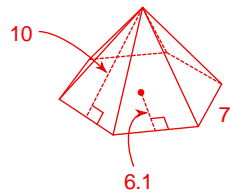
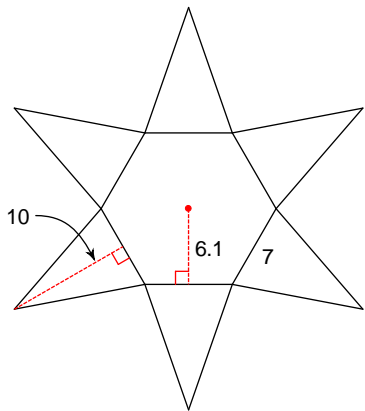

180)

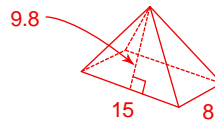
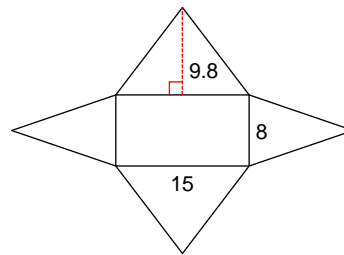

181)

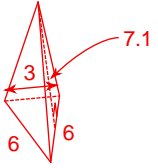
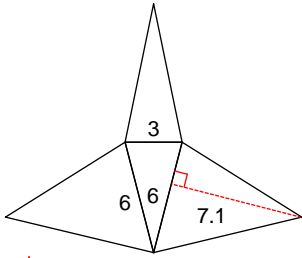

182)

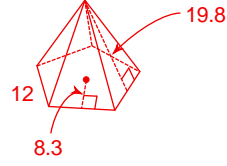
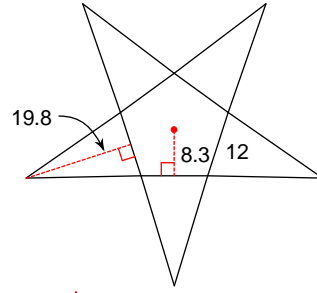

183)

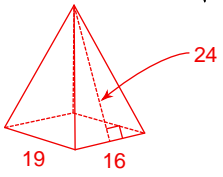
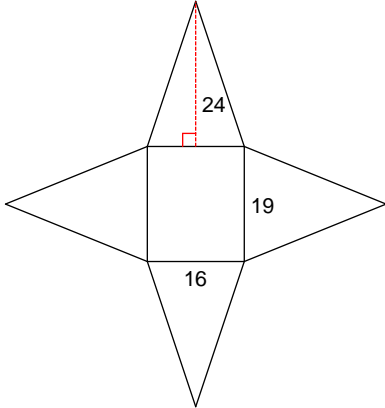

184)

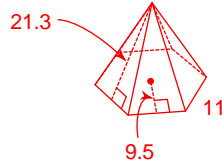
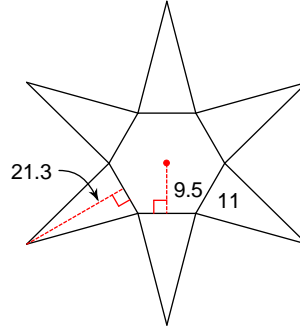

185)

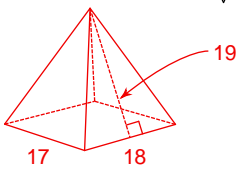
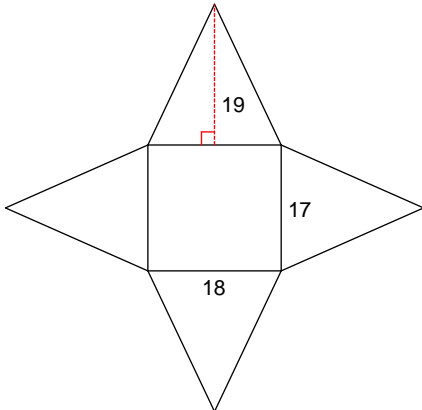

186)

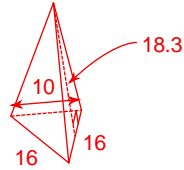
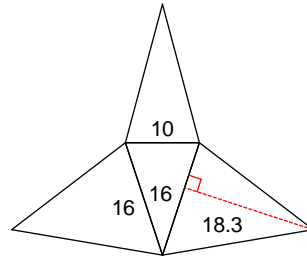

187)

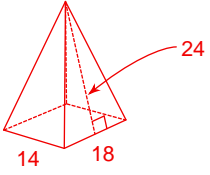
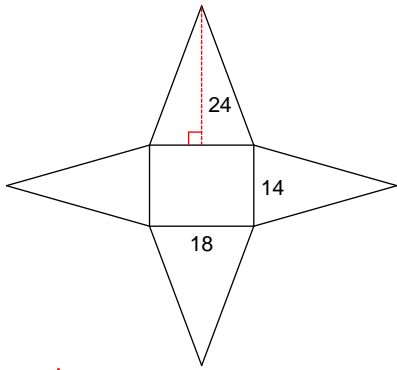

188)

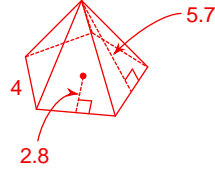
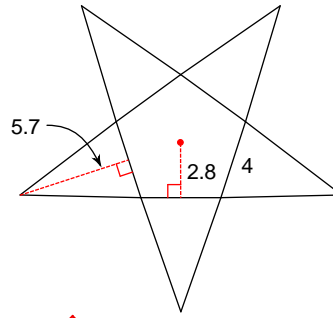

189)

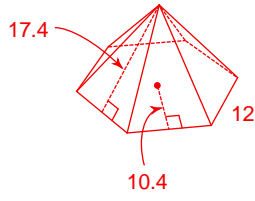
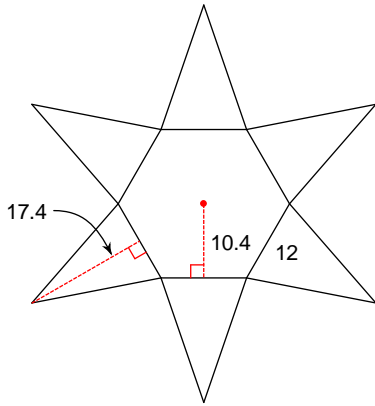

190)

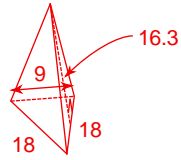
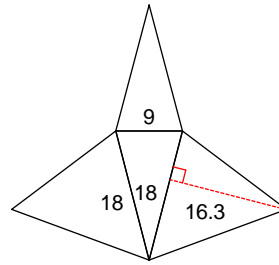

191)

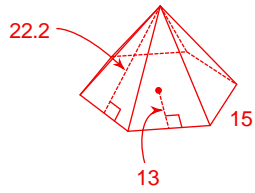
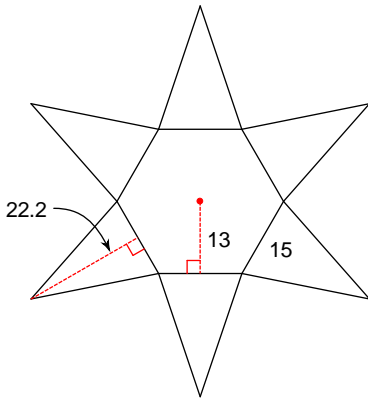

192)

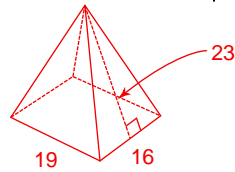
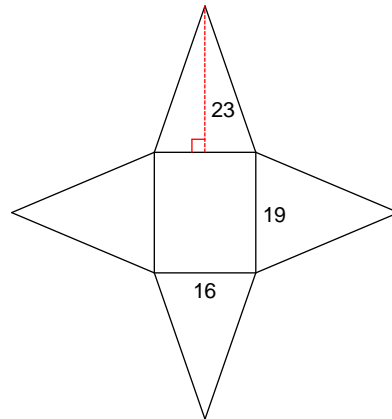

193)

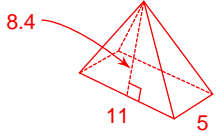
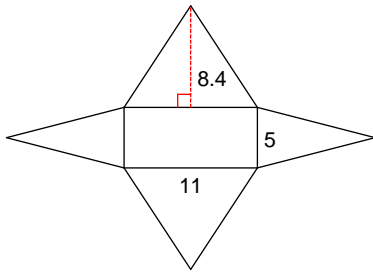

194)

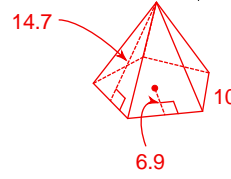
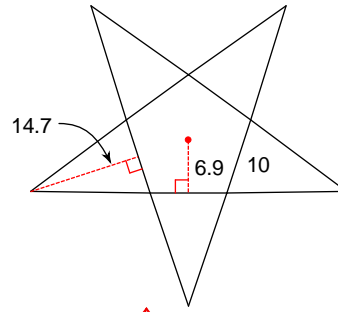

195)

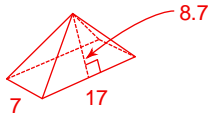
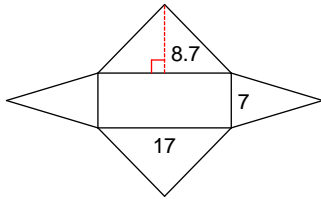

196)

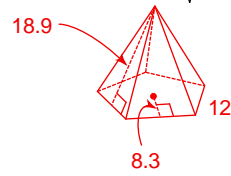
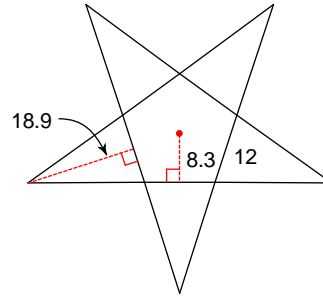

197)

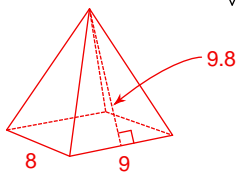
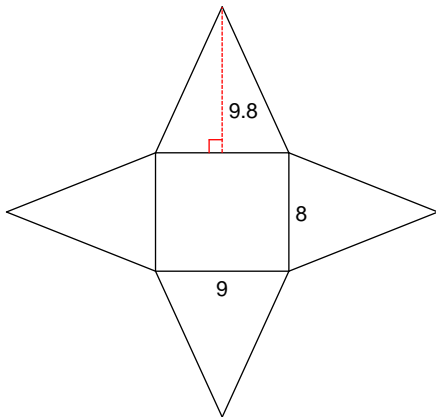

198)

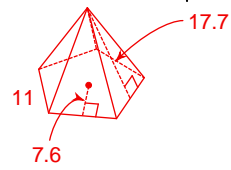
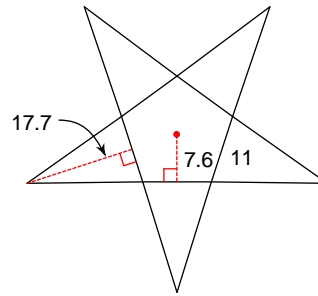

199)

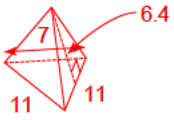
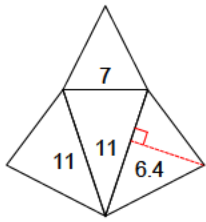

200)

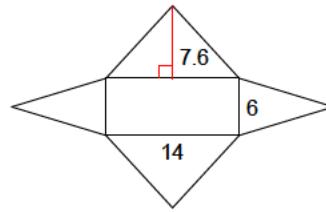

Draw a solid from given net of random solid:

201)

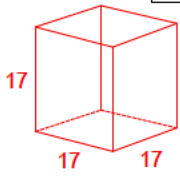
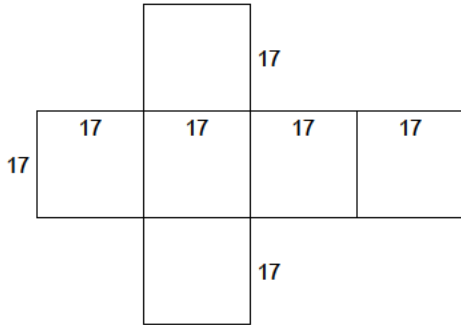

202)

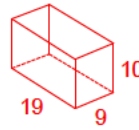
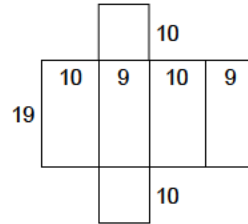

203)

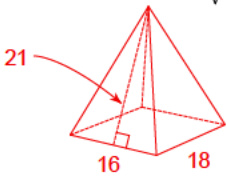
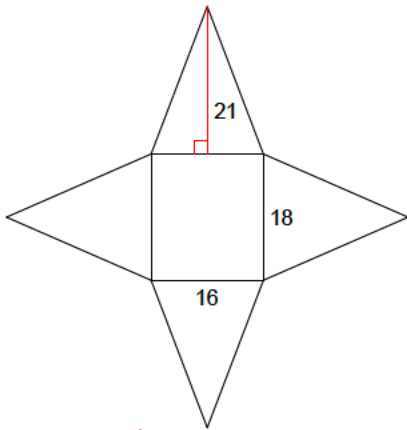

204)

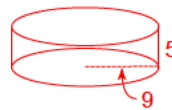
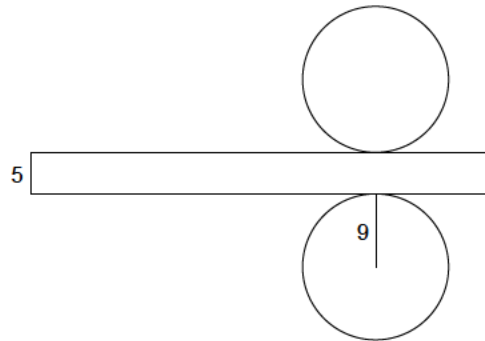

205)

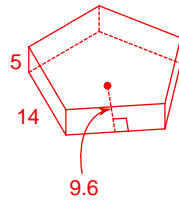
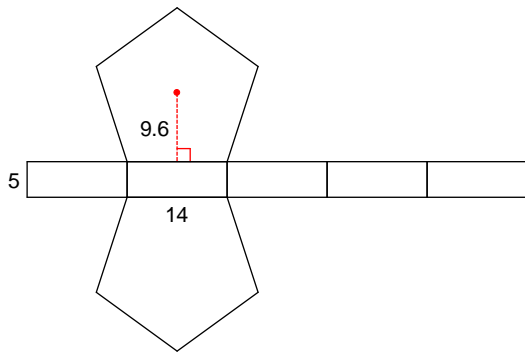

206)

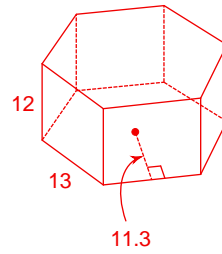
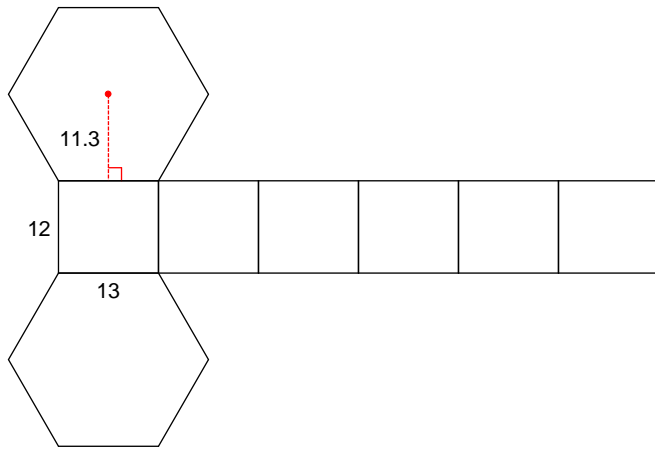

207)

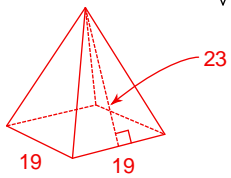
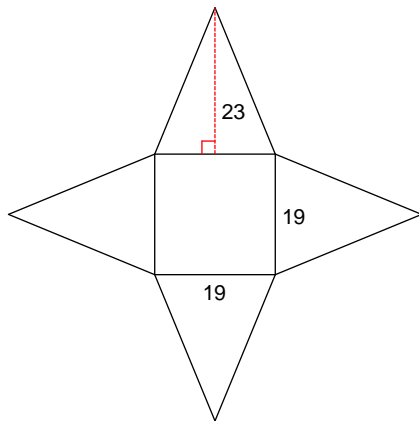

208)

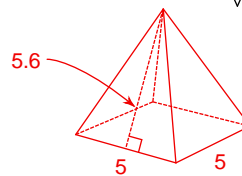
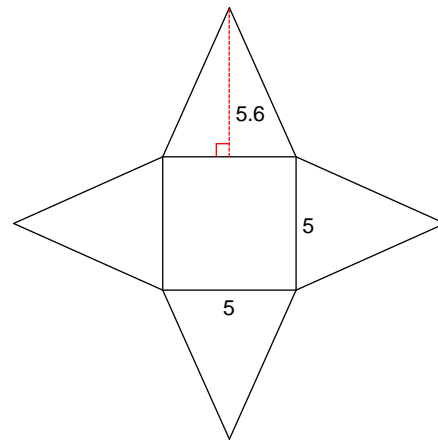

209)

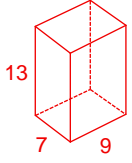
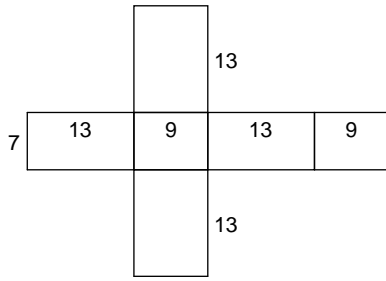

210)

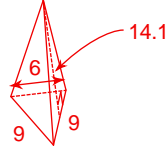
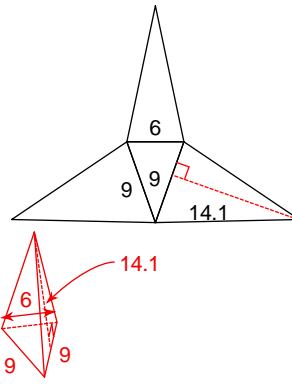

211)

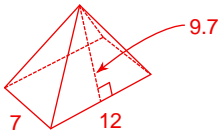
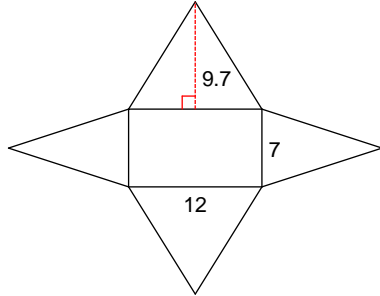

212)

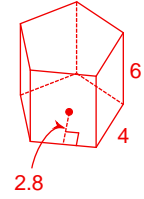
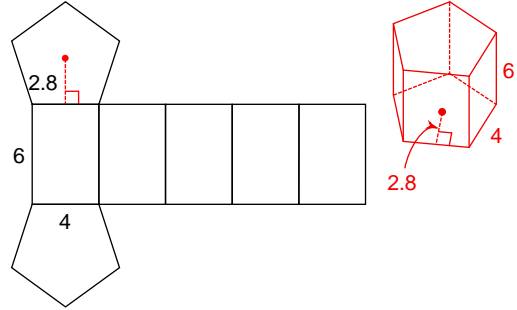

213)

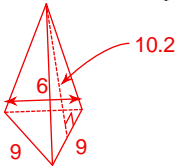
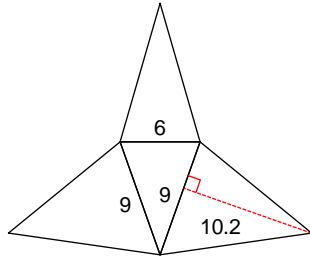

214)

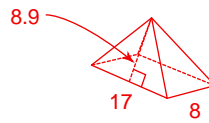
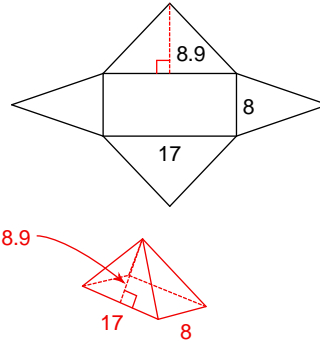

215)

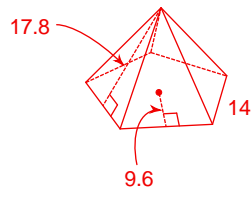
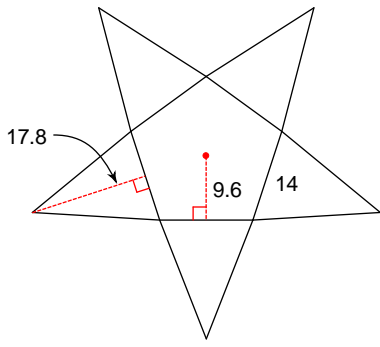

216)

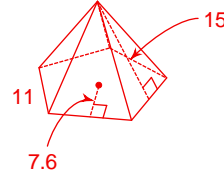
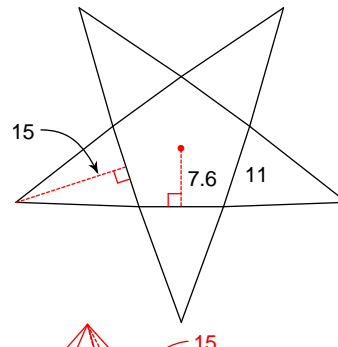

217)

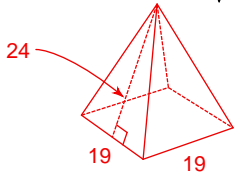
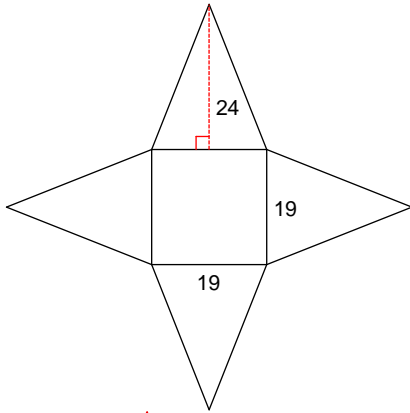

218)

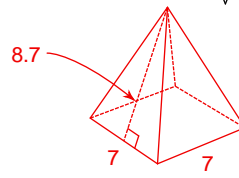
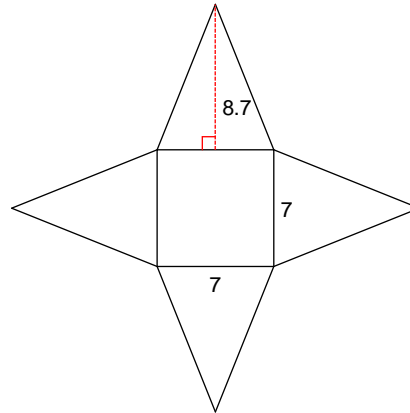

219)

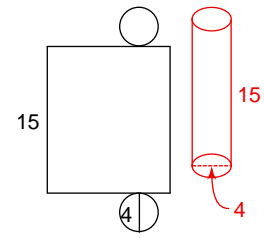
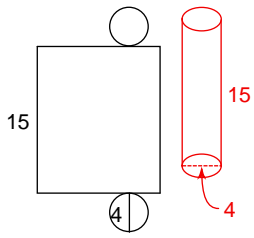

220)

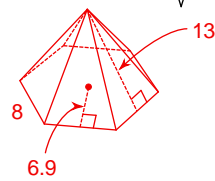
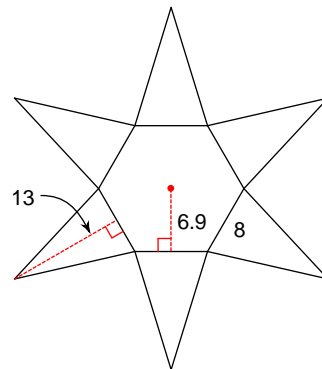

221)

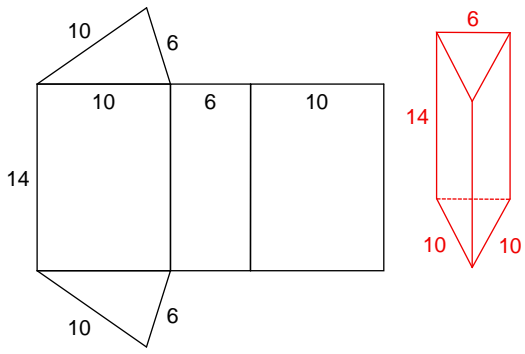

222)

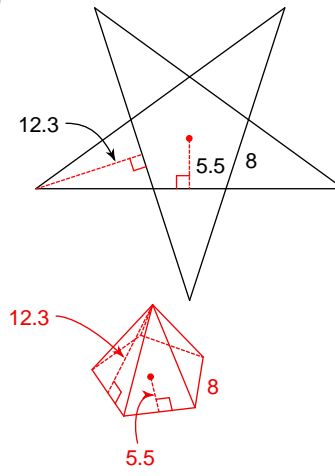

223)

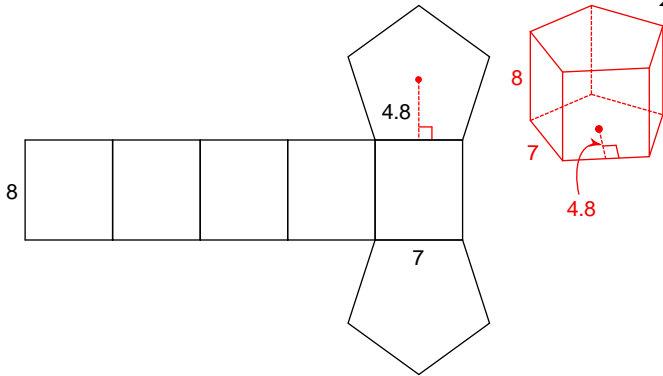

224)

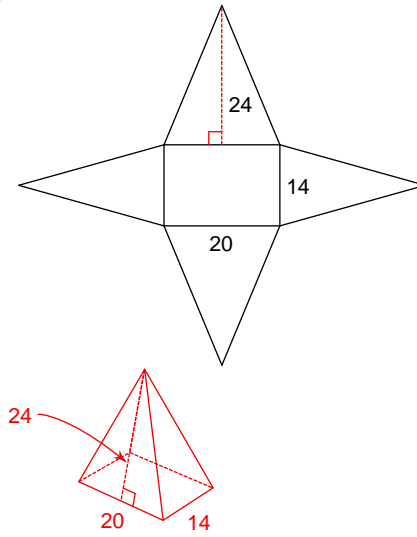

225)

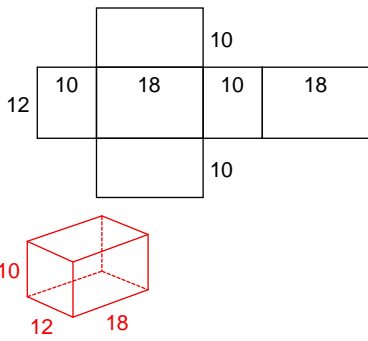

226)

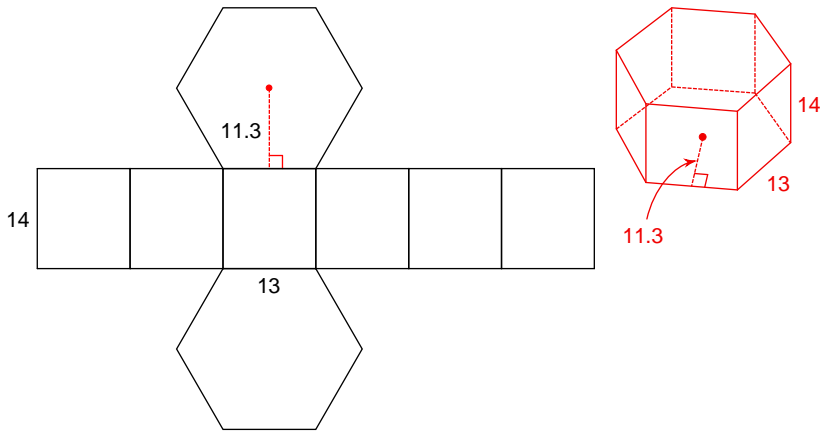

227)

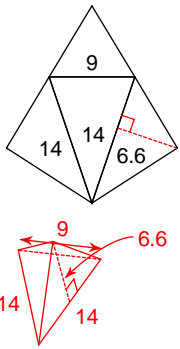

228)

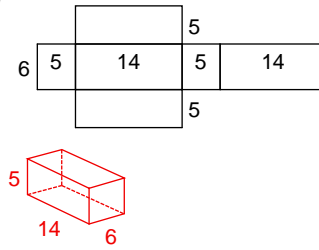

229)

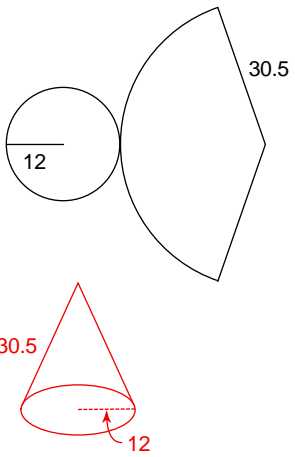

230)

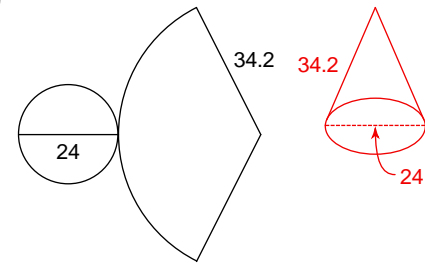

231)

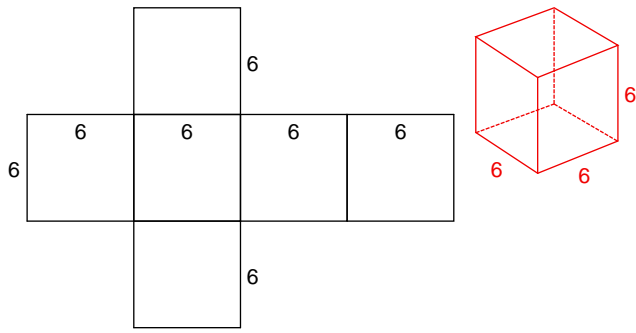

232)

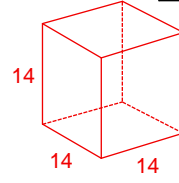
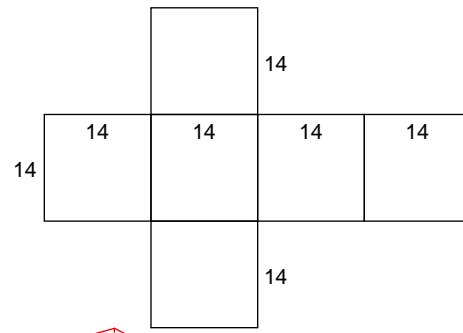

233)

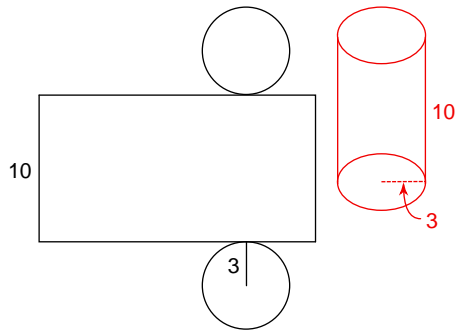

234)

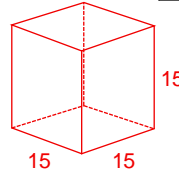
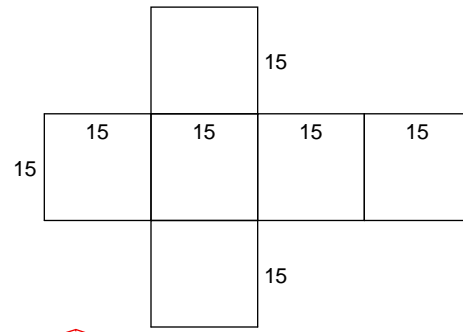

235)

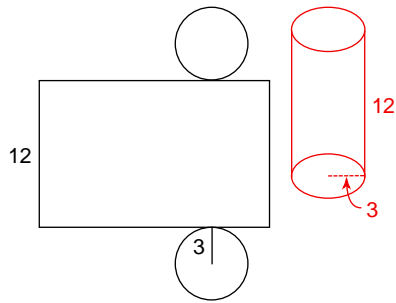

236)

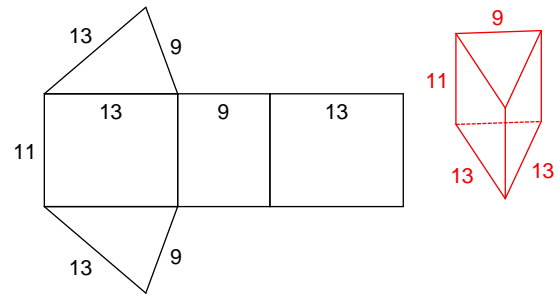

237)

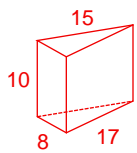
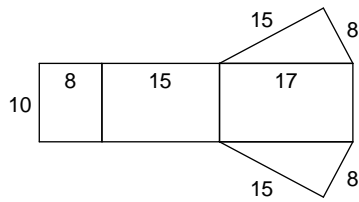

238)

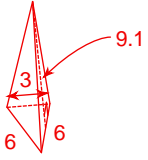
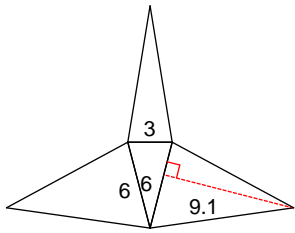

239)

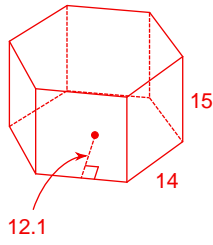
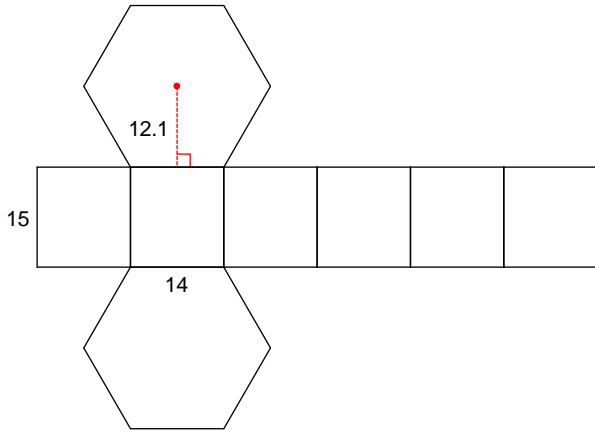

240)

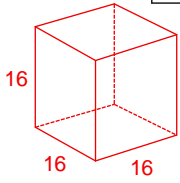
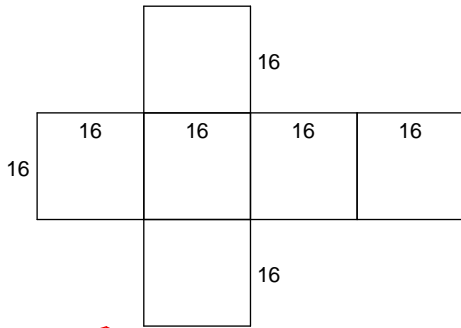

241)

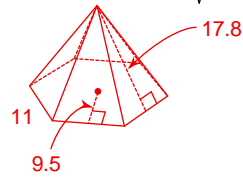
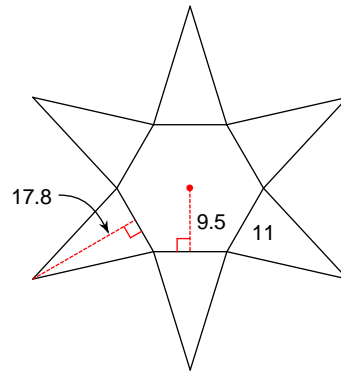

242)

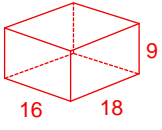
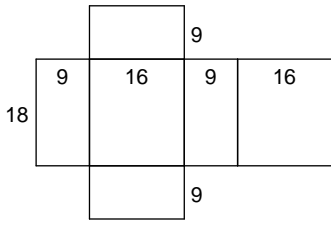

243)

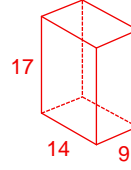
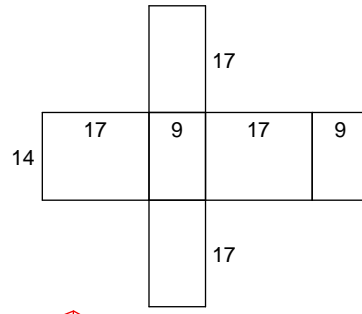

244)

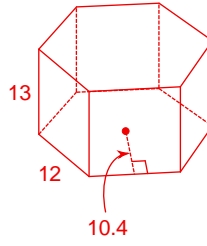
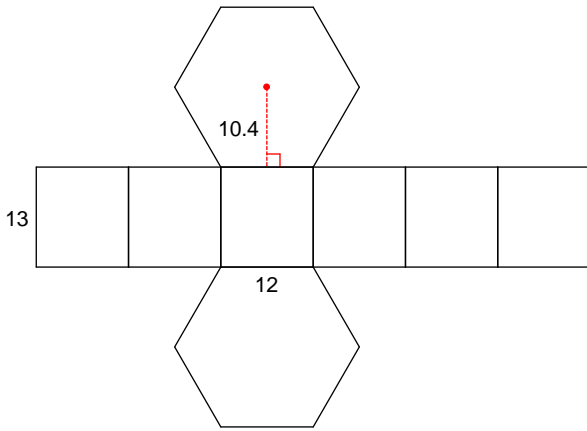

245)

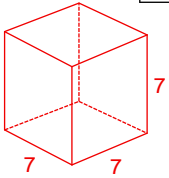
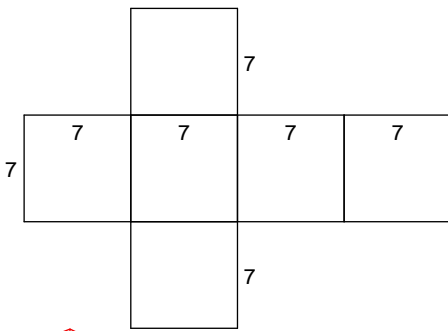

246)

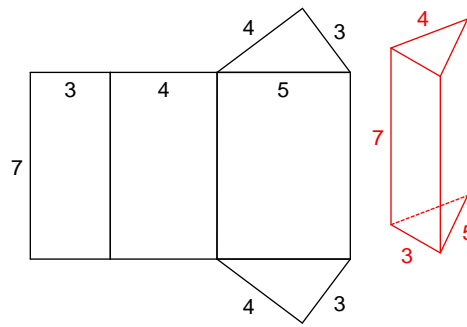

247)

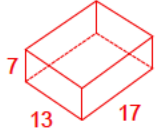
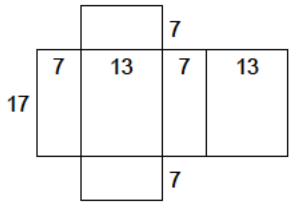

248)

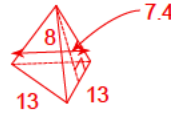
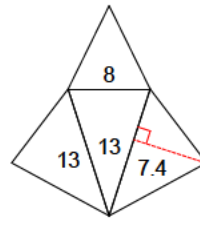

249)

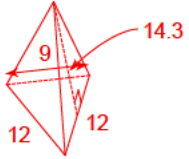
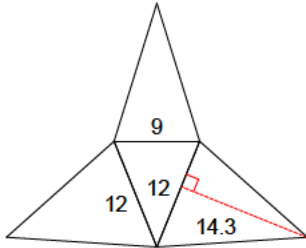

250)

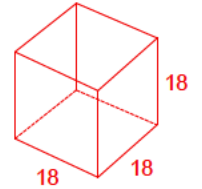
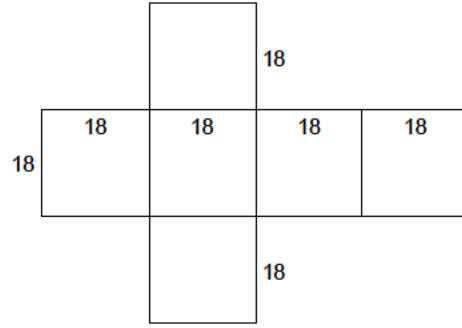

251)

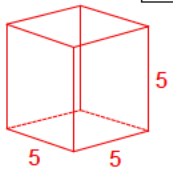
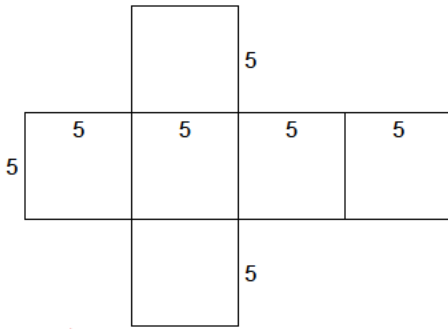

252)

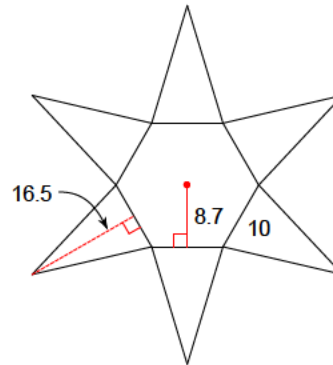

253)

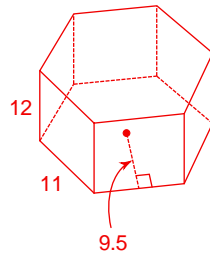
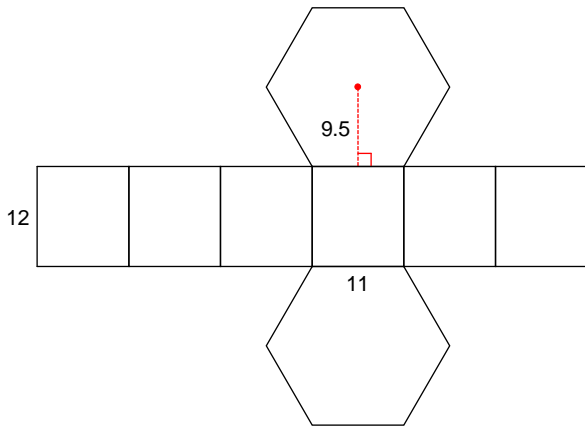

254)

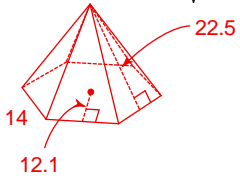
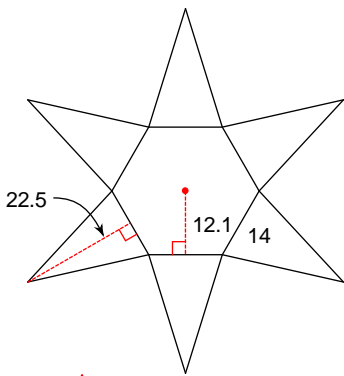

255)

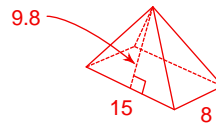
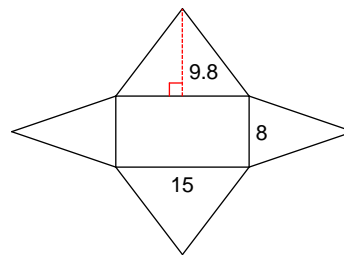

256)

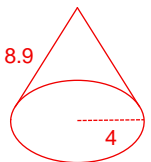
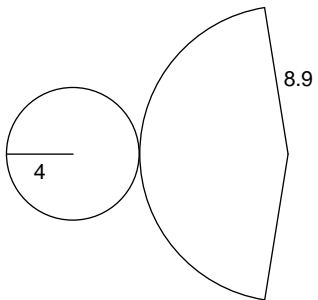

257)

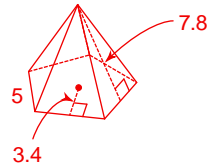
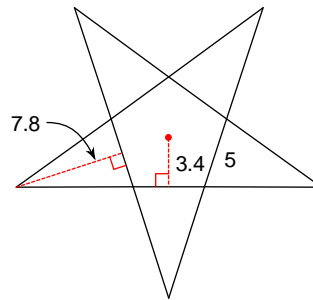

258)

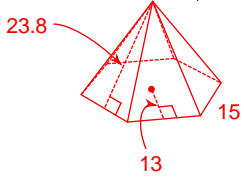
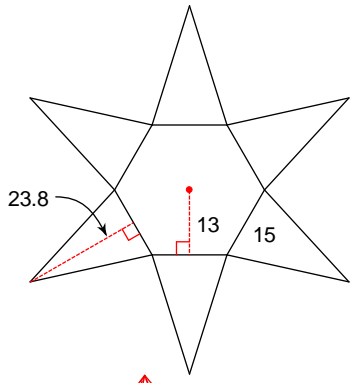

259)

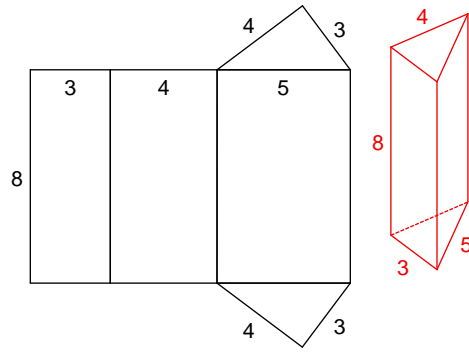

260)

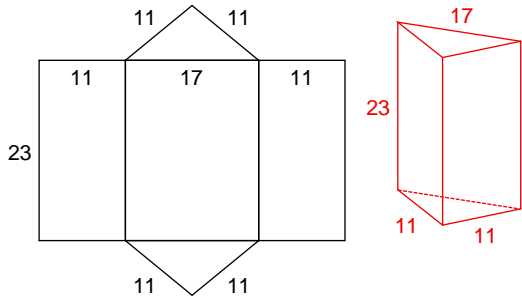

261)

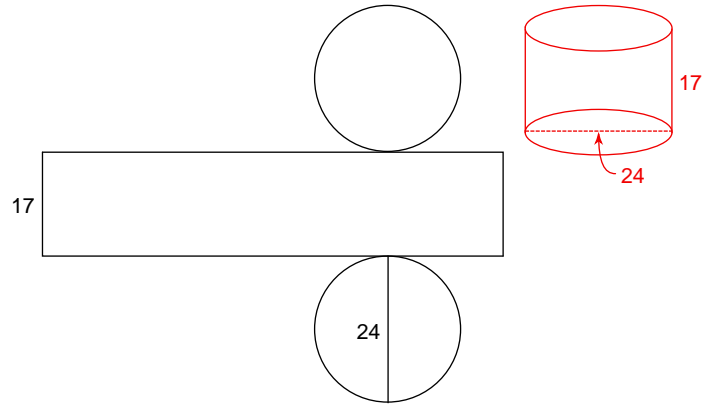

262)

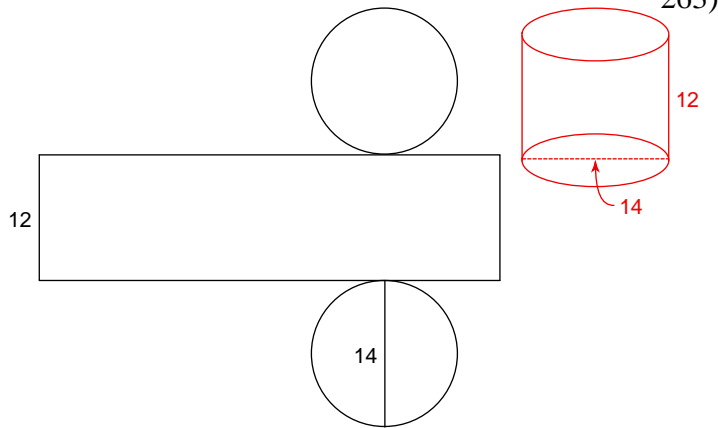

263)

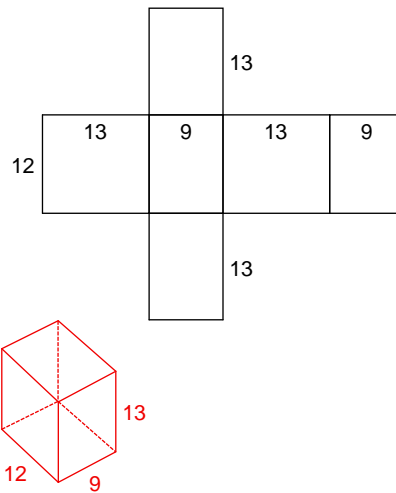

264)

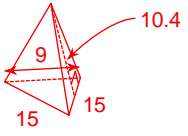
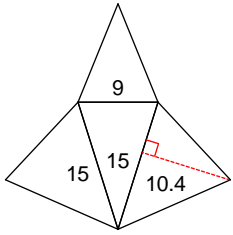

265)

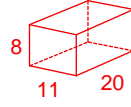
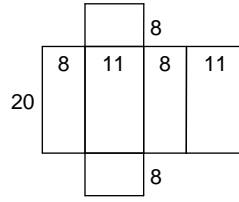

266)

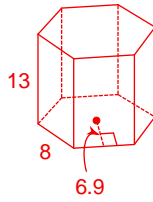
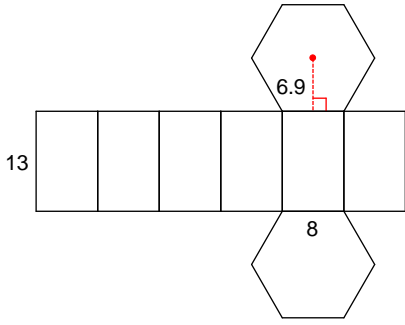

267)

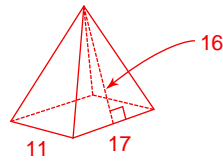
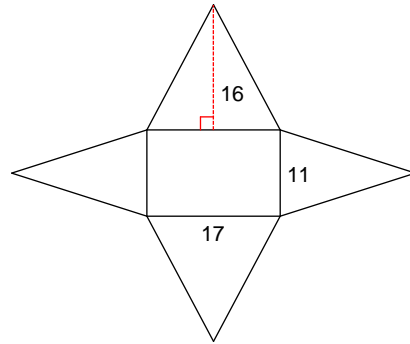

268)

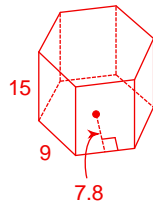
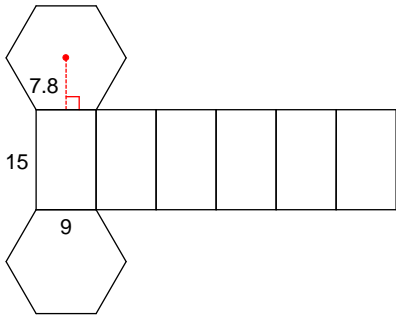

269)

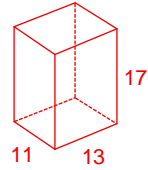
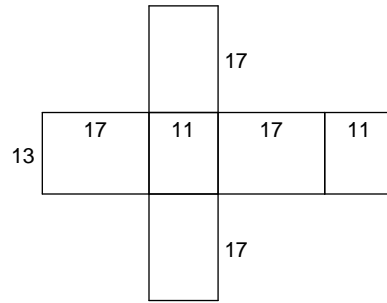

270)

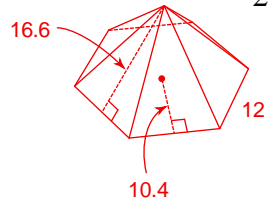
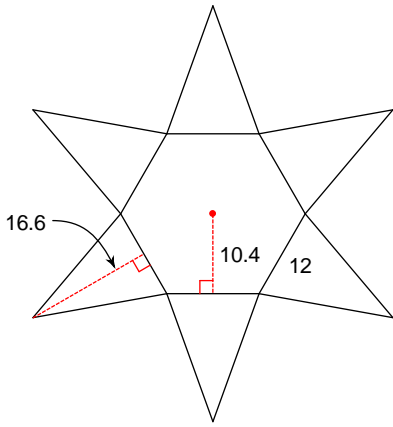

271)

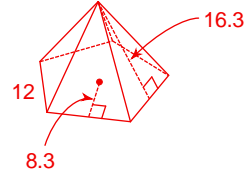
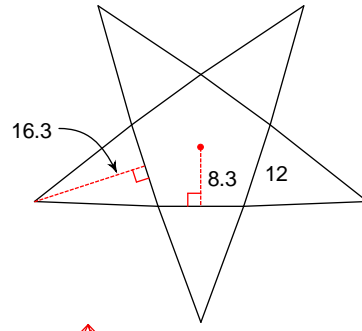

272)

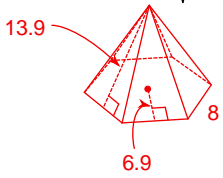
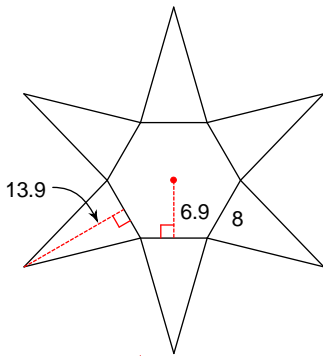

273)

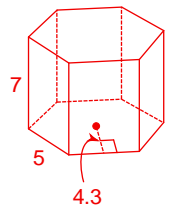
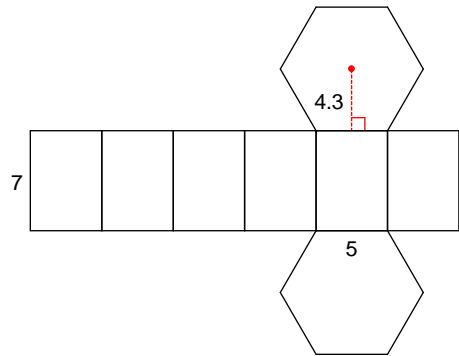

274)

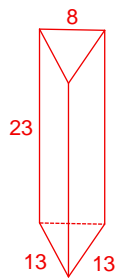
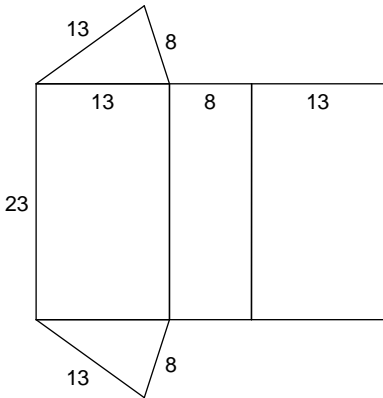

275)

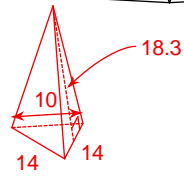
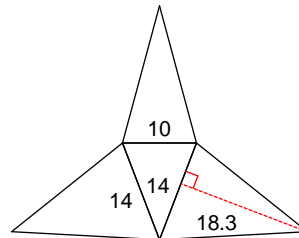

276)

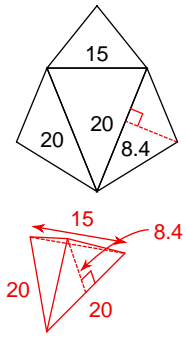

277)

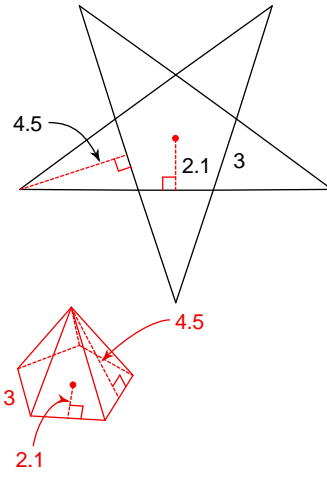

278)

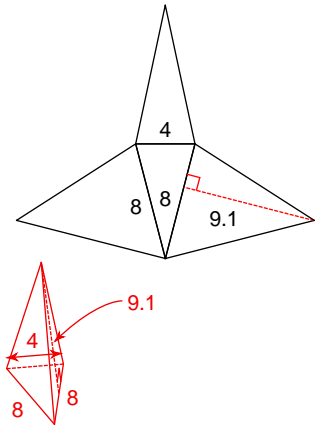

279)

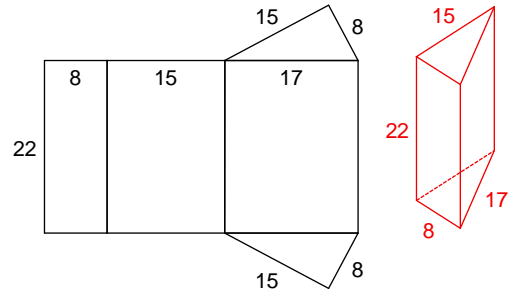

280)

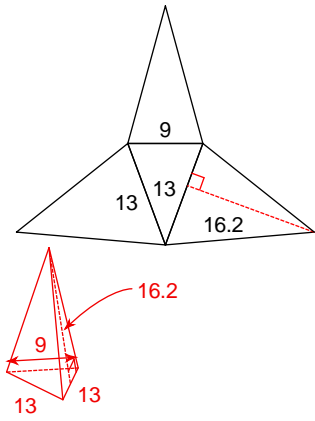

281)

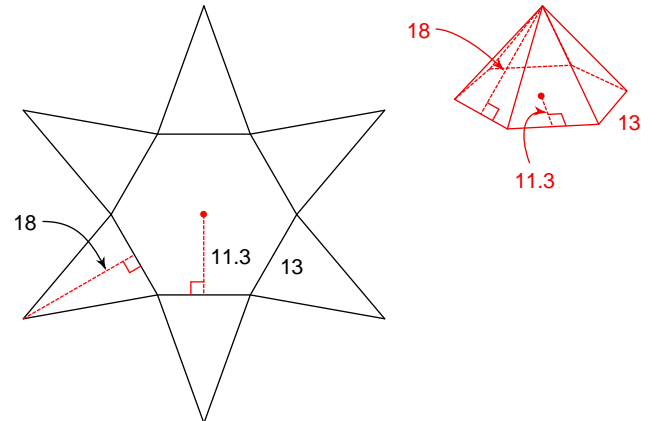

282)

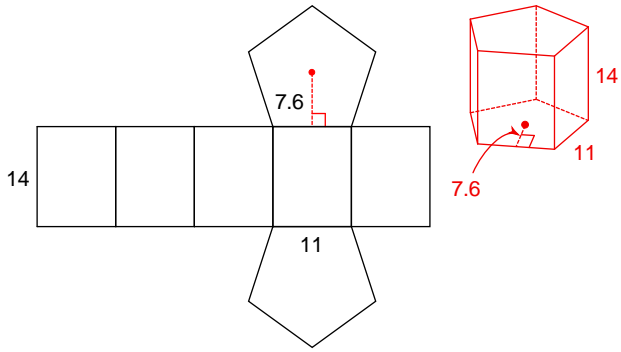

283)

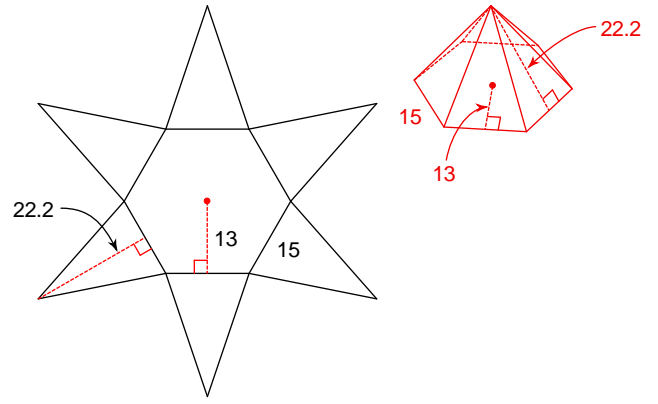

284)

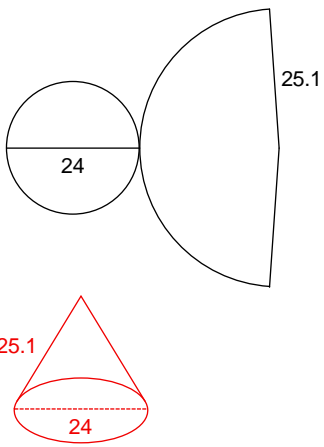

285)

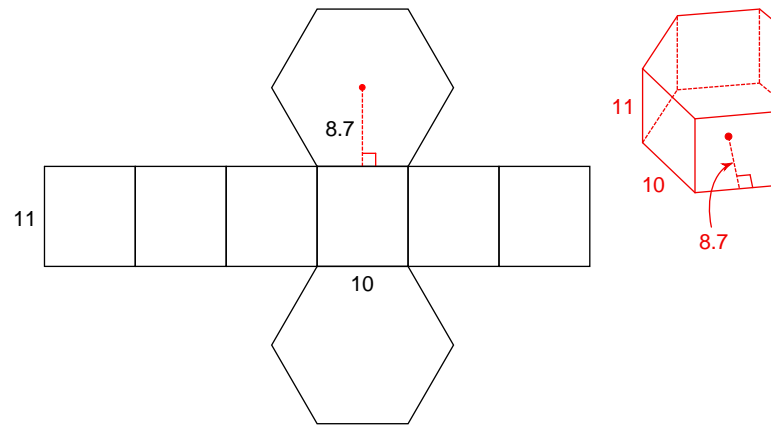

286)

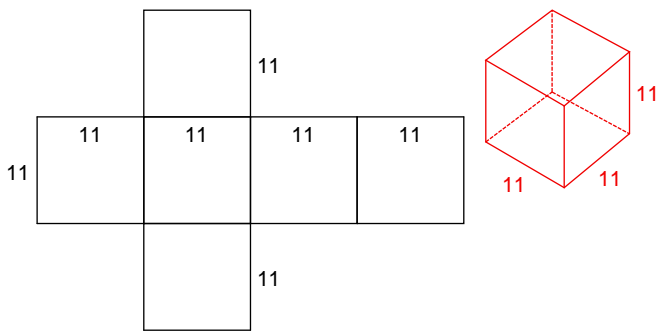

287)

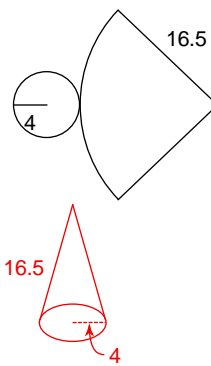

288)

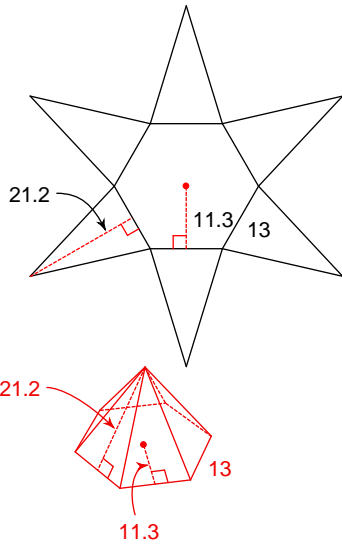

289)

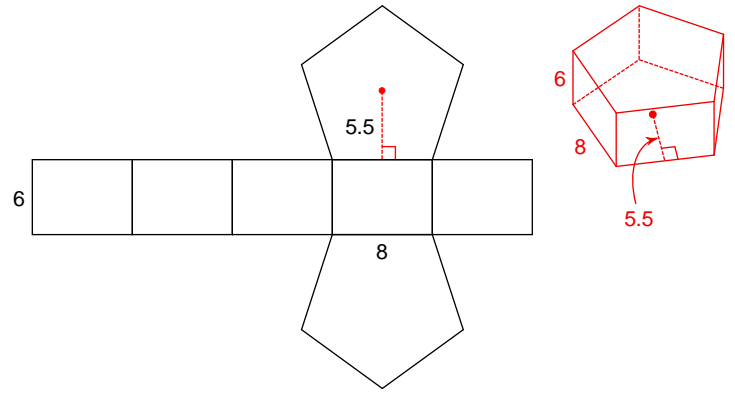

290)

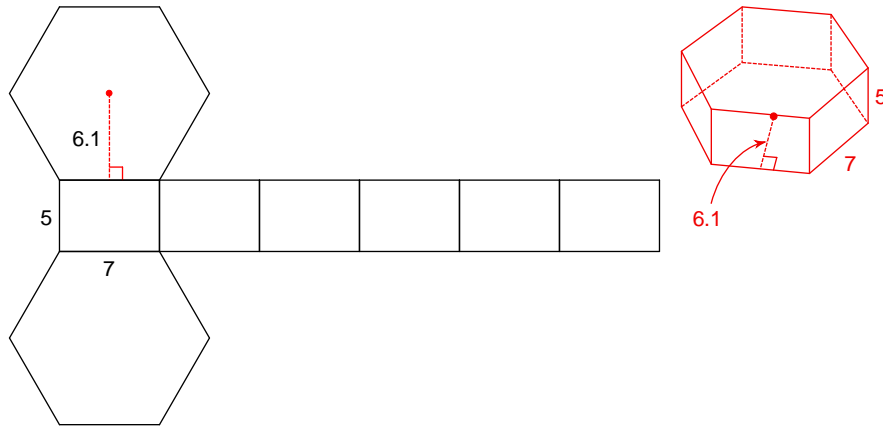

291)

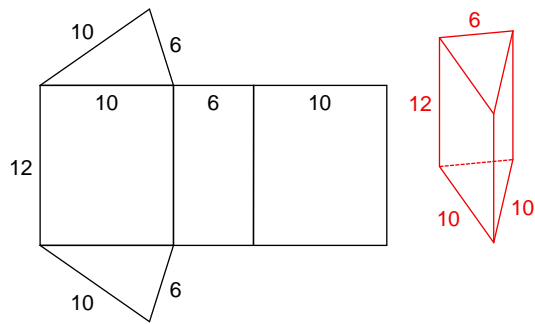

292)

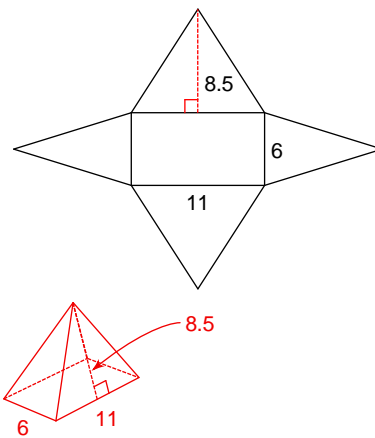

293)

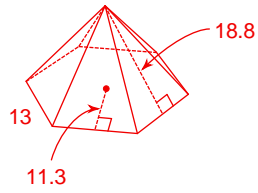
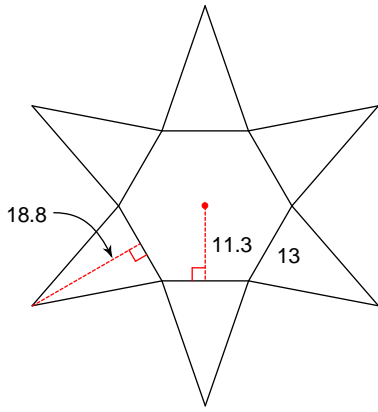

294)

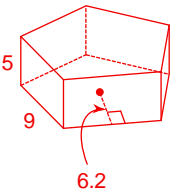
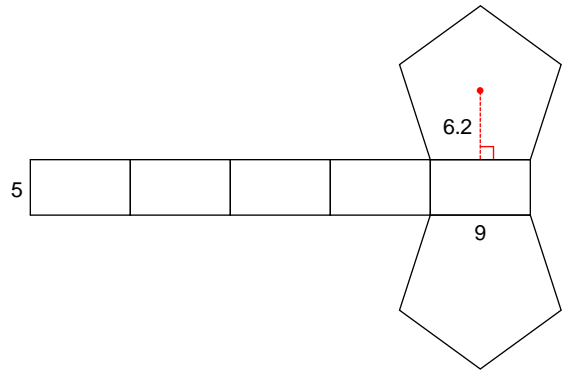

295)

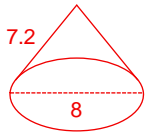
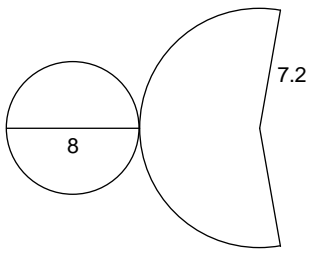

296)

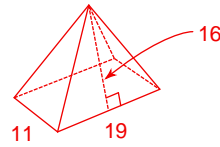
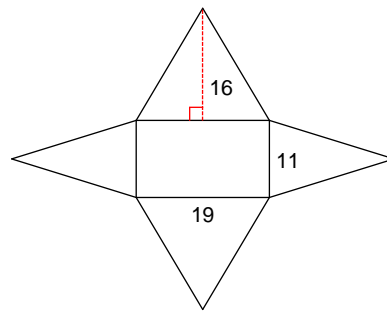

297)

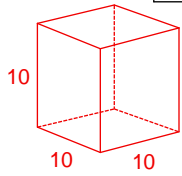
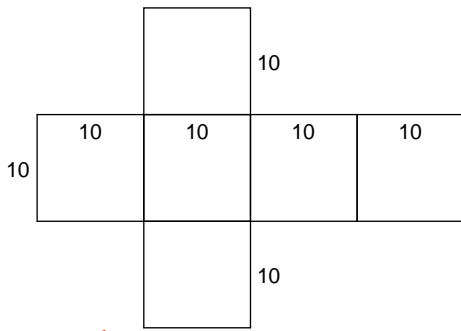

298)

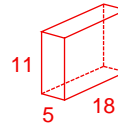
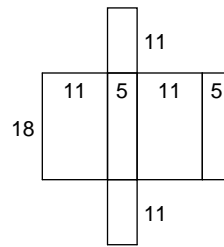

299)

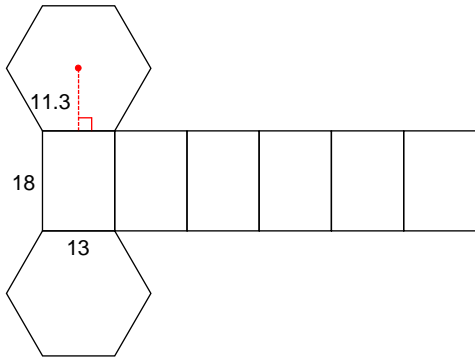

300)

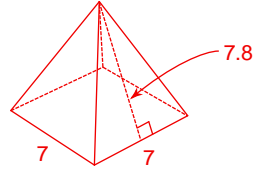
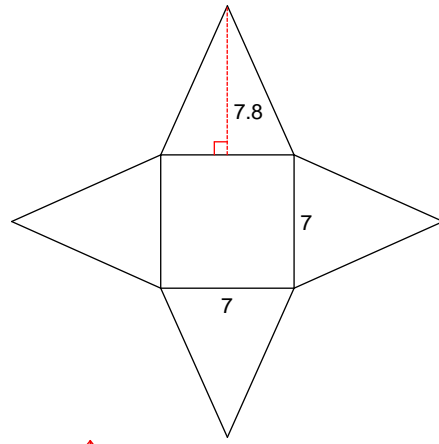
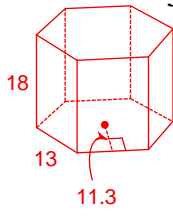

301)

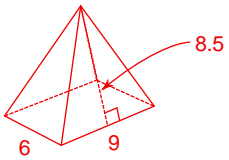
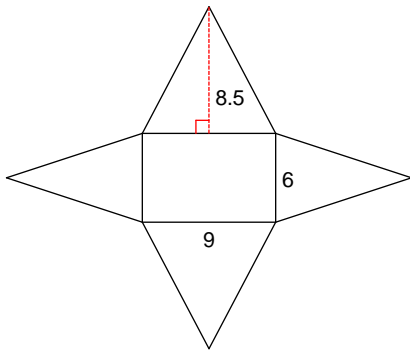

302)

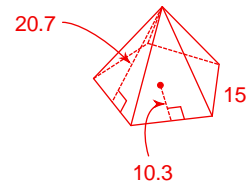
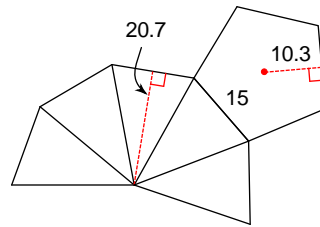

303)

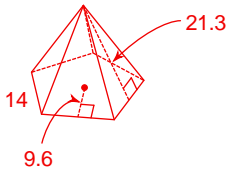
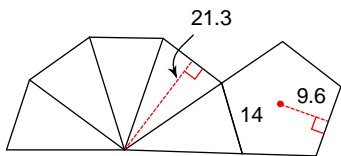

304)

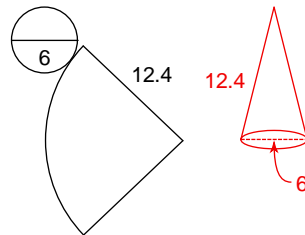

305)

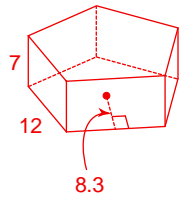
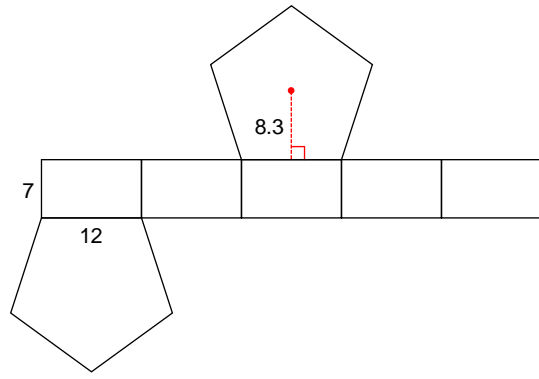
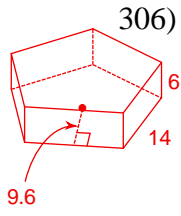
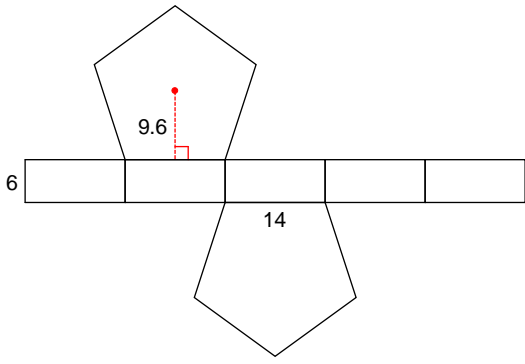

307)

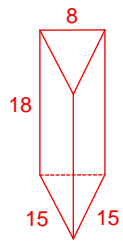
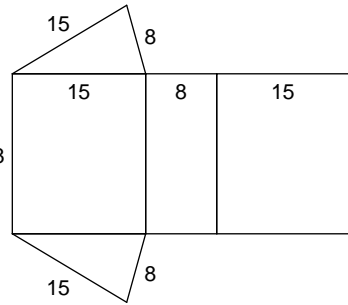
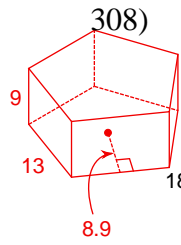
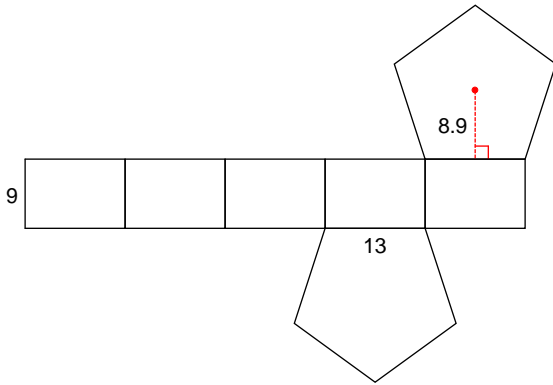

309)

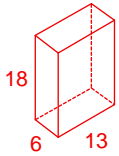
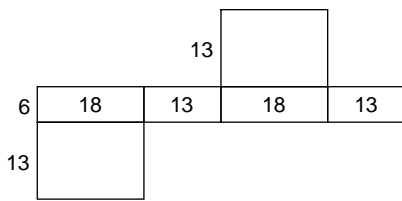

310)

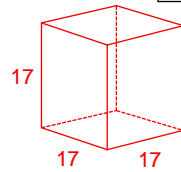
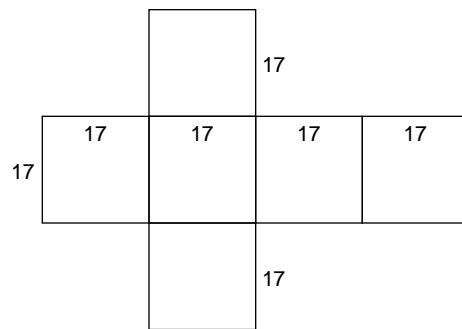

311)

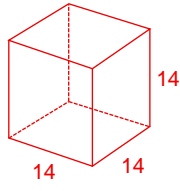
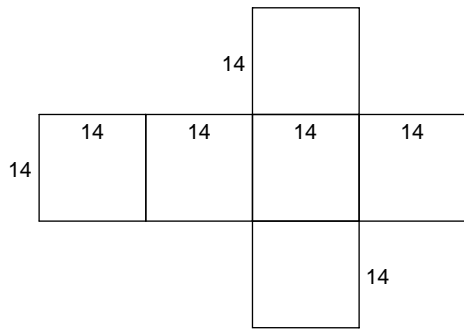

312)

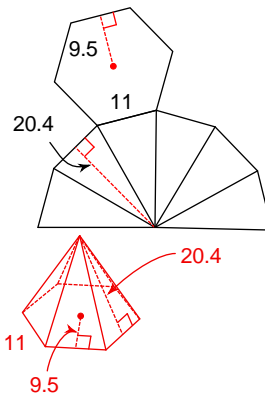

313)

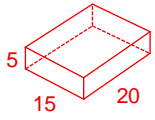
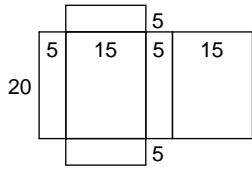

314)

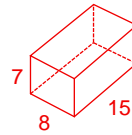
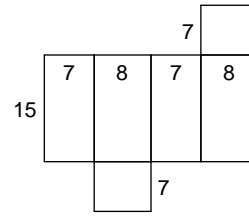

315)

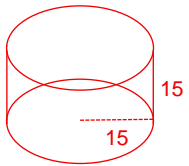
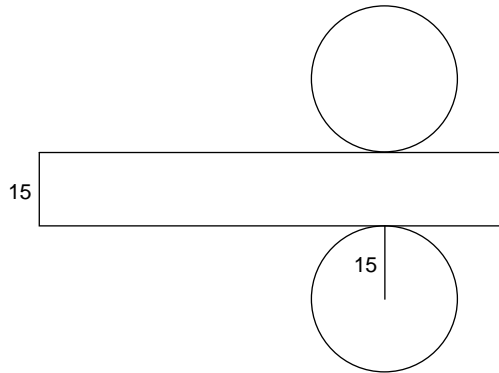

316)

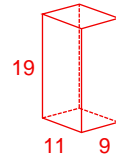
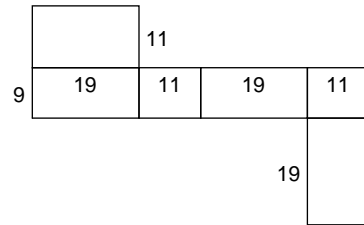

317)

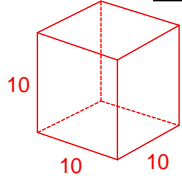
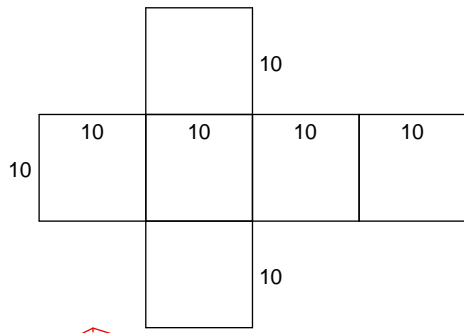

319)

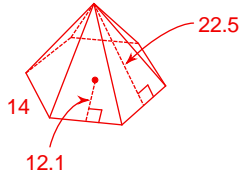
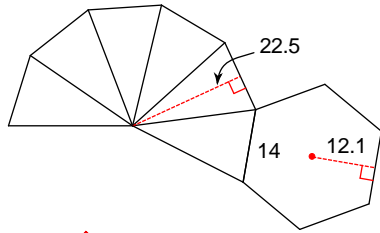

321)

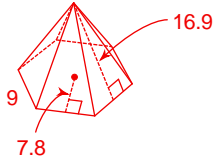
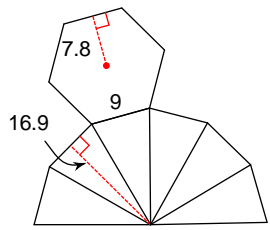

318)

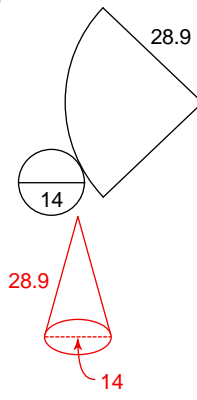

320)

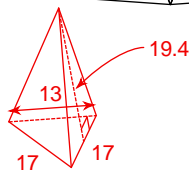
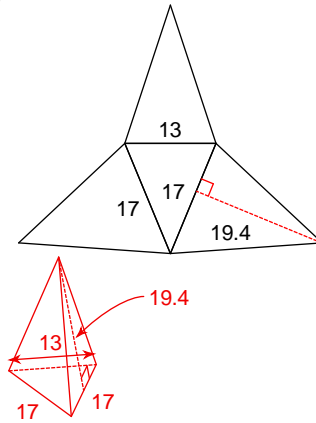

322)

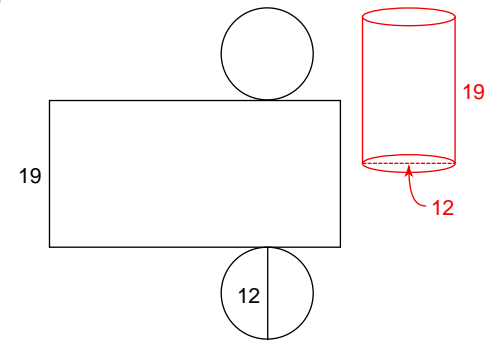

323)

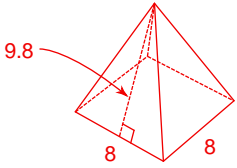
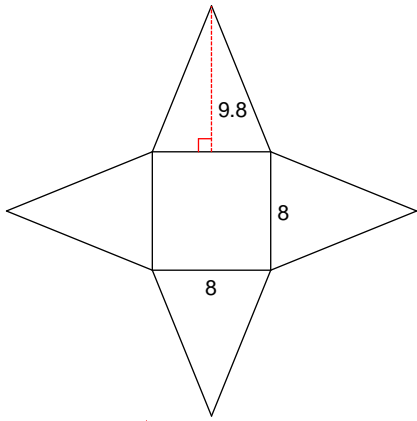

324)

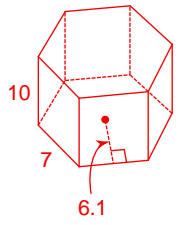
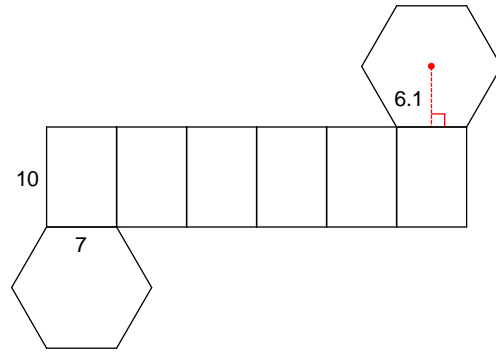

325)

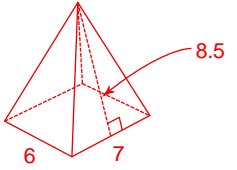
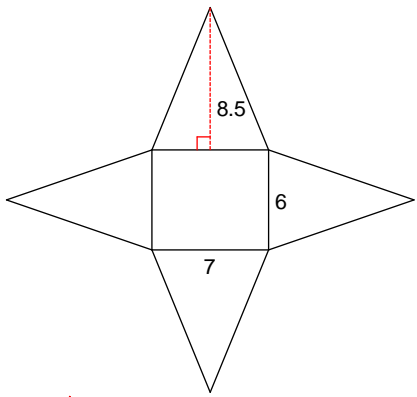

326)

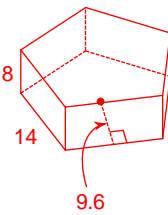
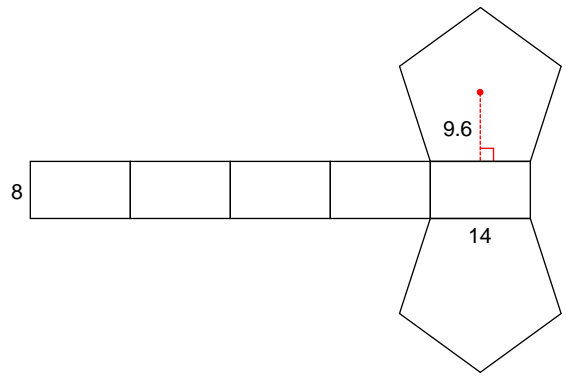

327)

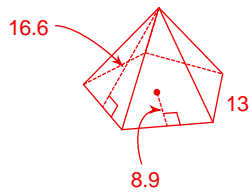
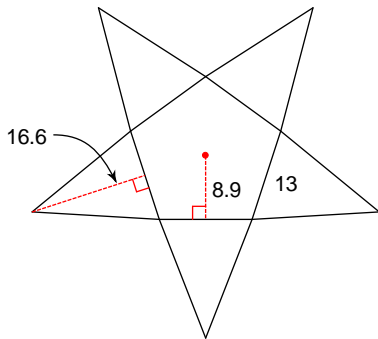

328)

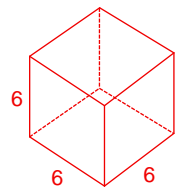
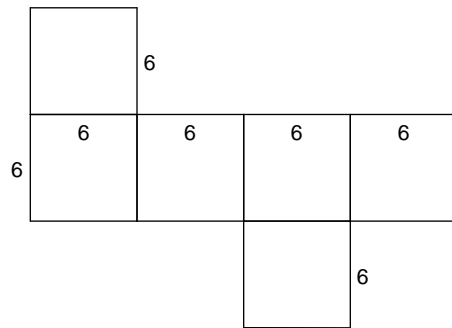

329)

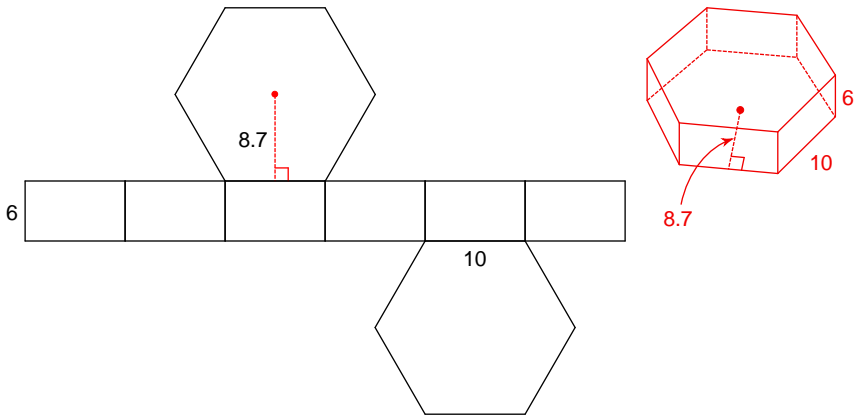

330)

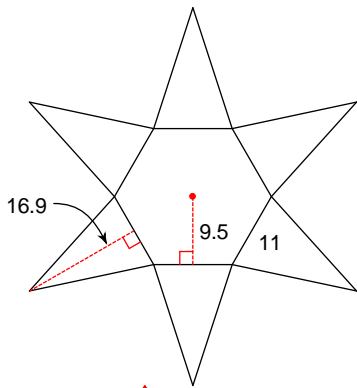

331)

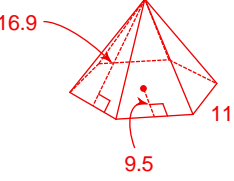
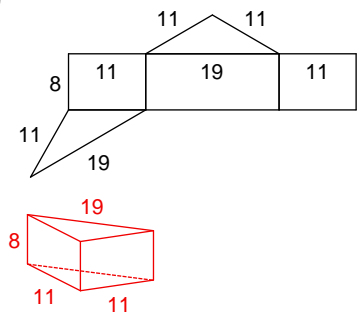

332)

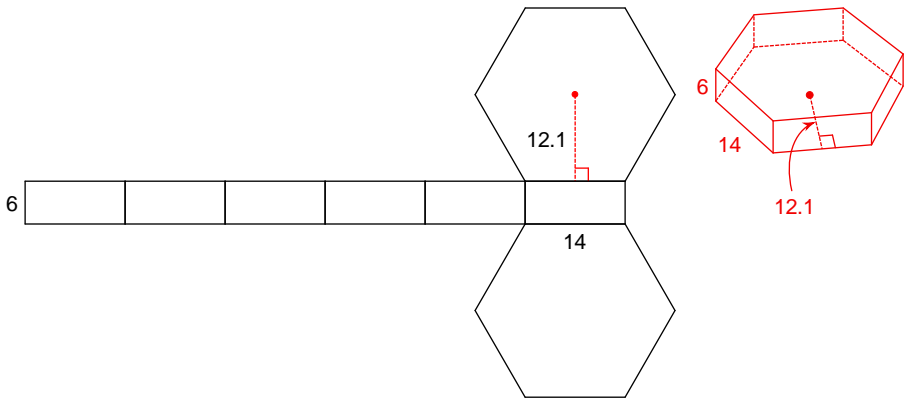

333)

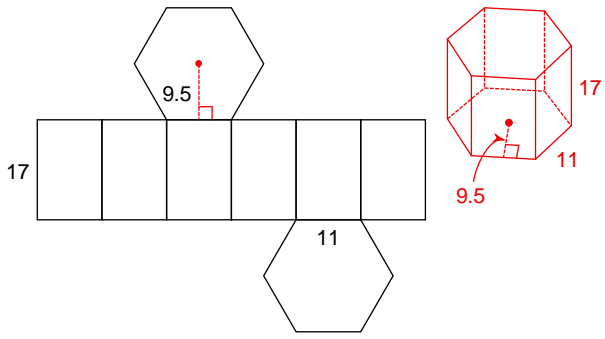

334)

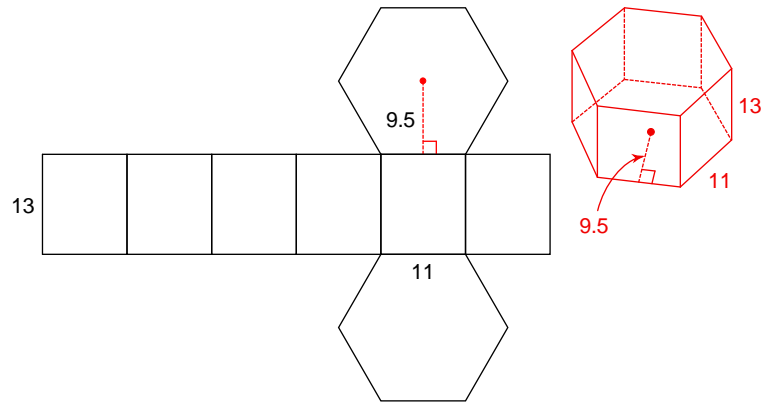

335)

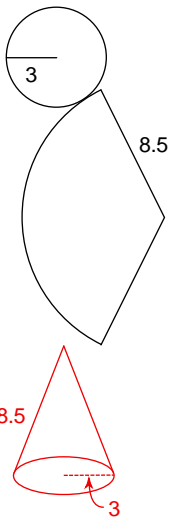

336)

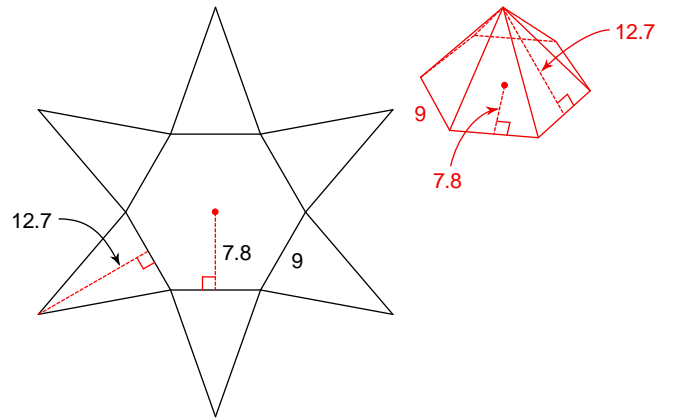

337)

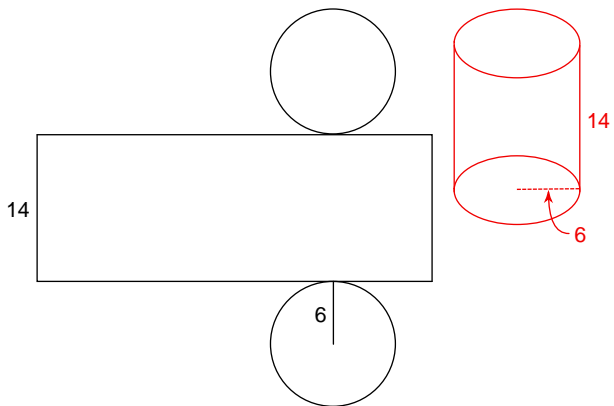

338)

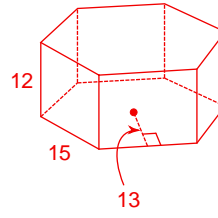
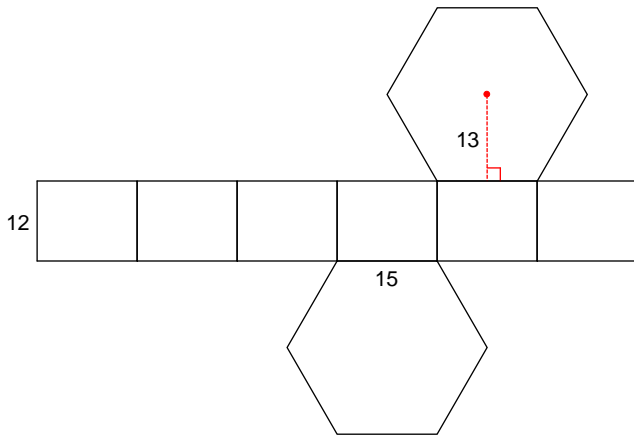

339)

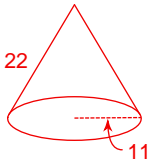
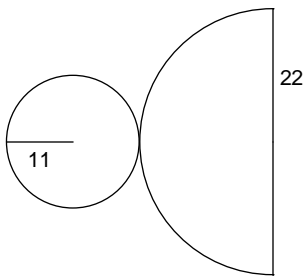

340)

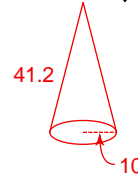
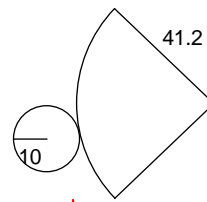

341)

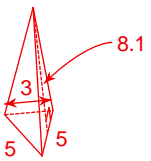
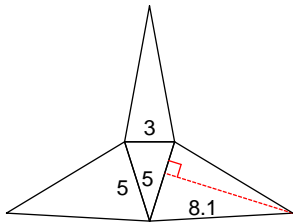

342)

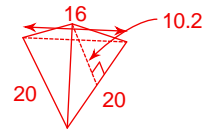
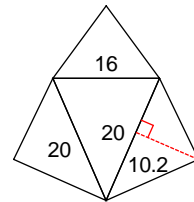

343)

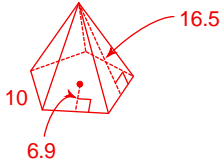
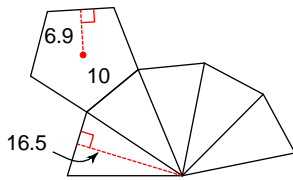

344)

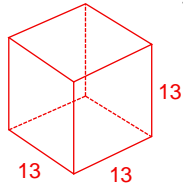
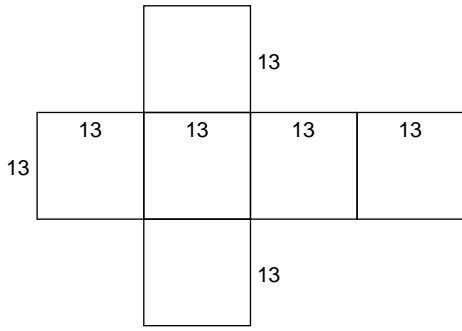

345)

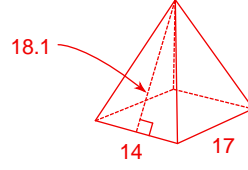
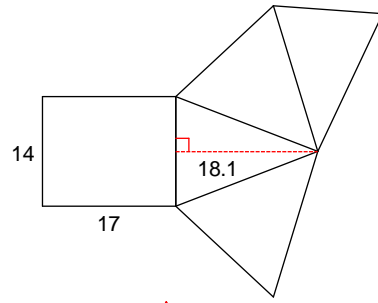

346)

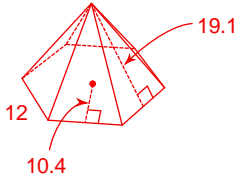
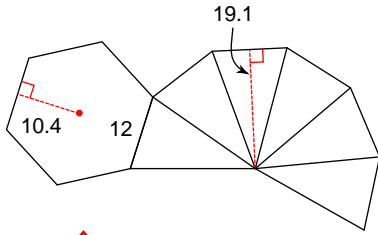

347)

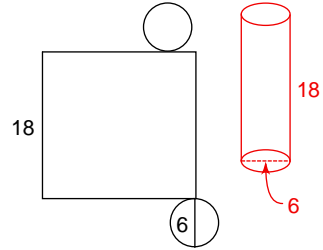

348)

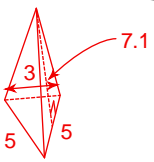
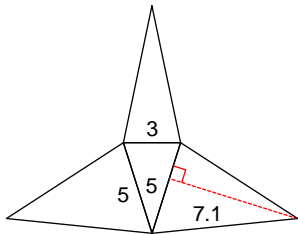

349)

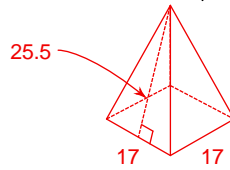
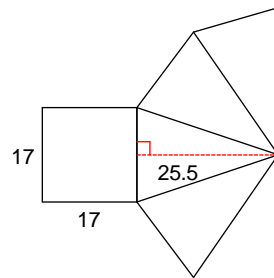

350)

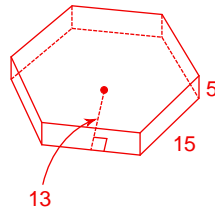
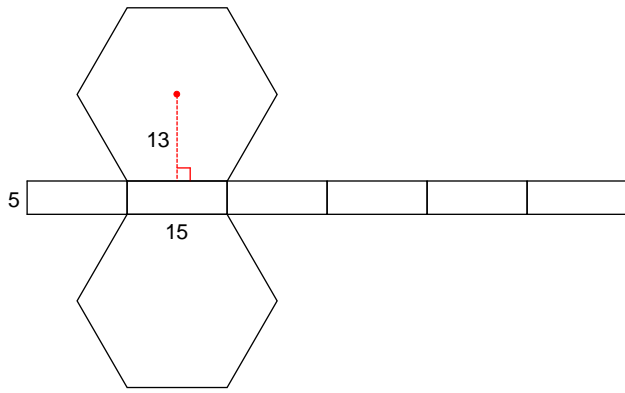

351)

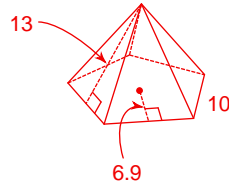
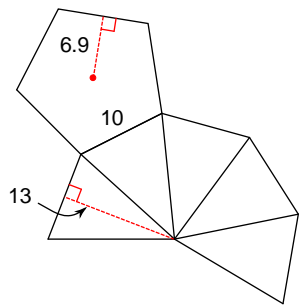

352)

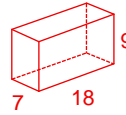
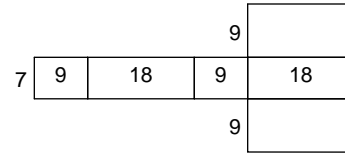

353)

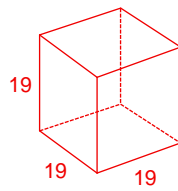
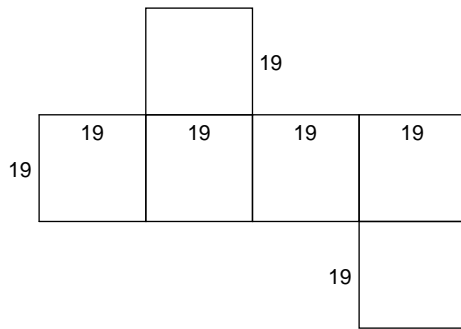

354)

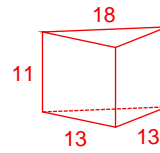
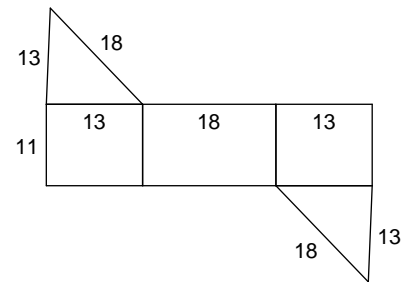

355)

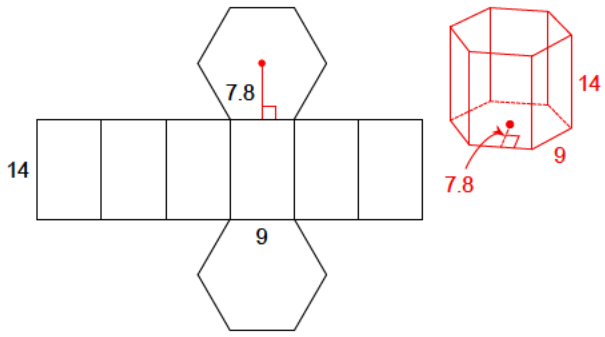

356)

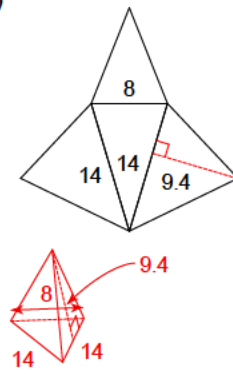

357)

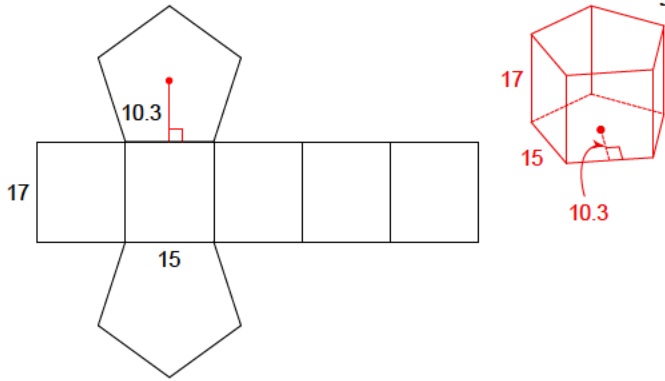

358)

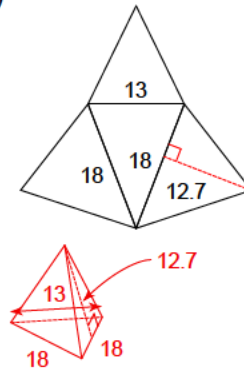

359)

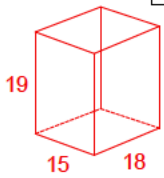
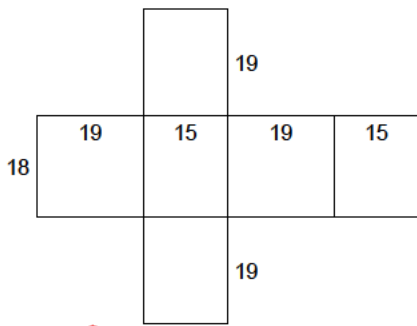

360)

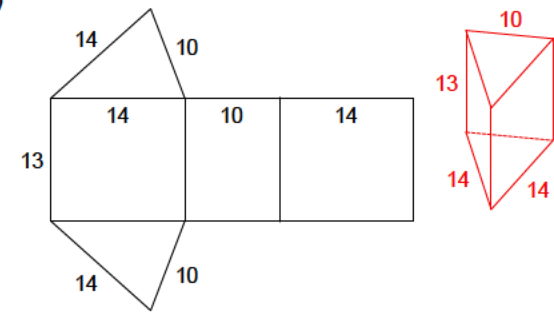

361)

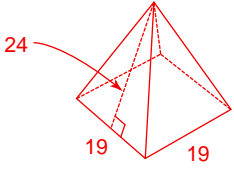
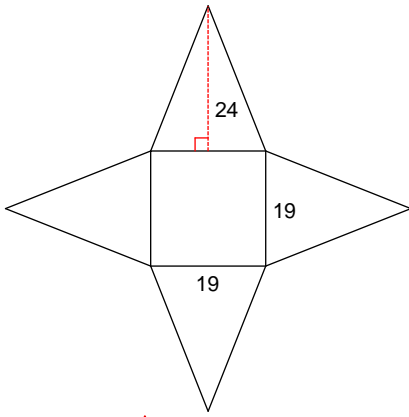

362)

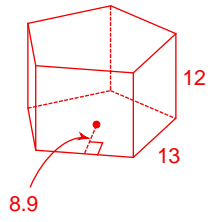
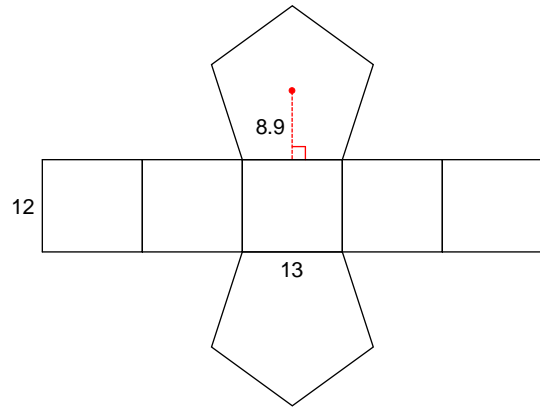

363)

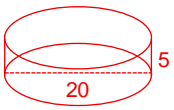
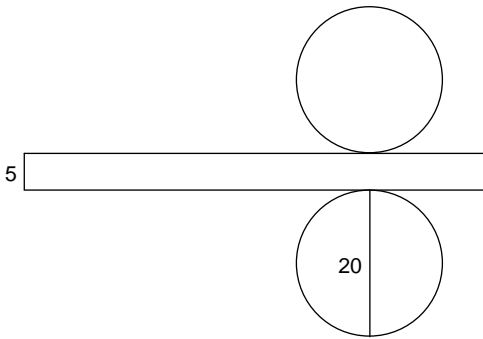

364)

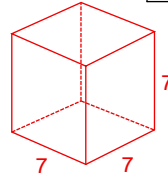
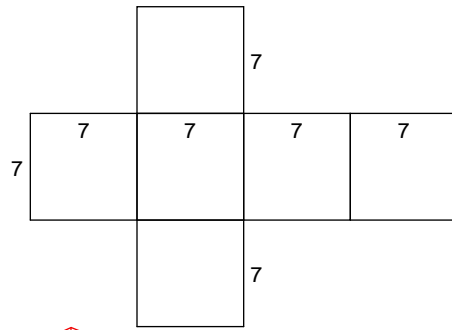

365)

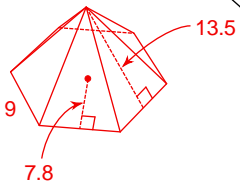
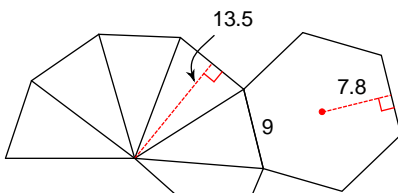

366)

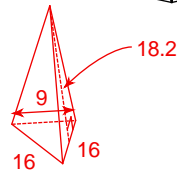
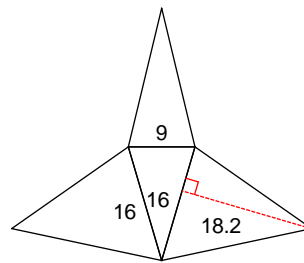

367)

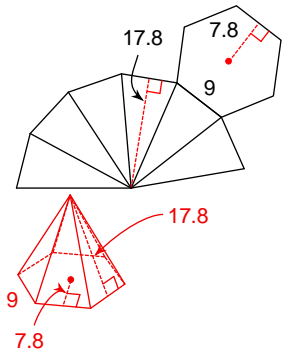

368)

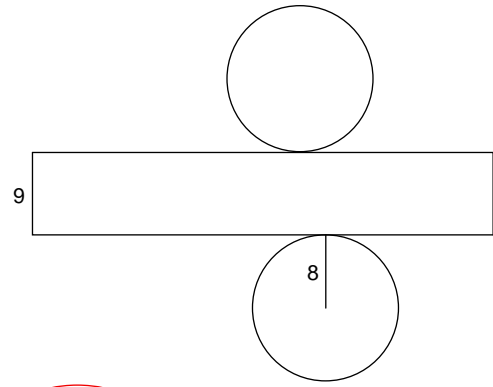

369)

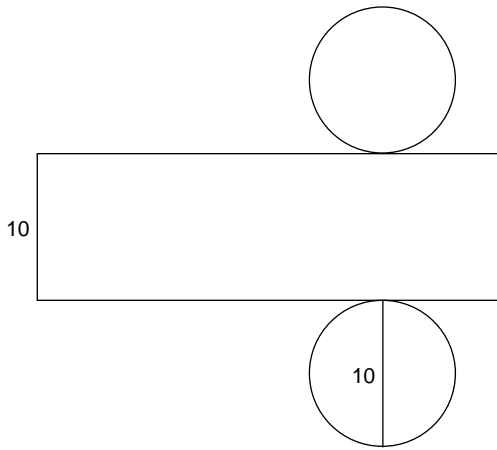

370)

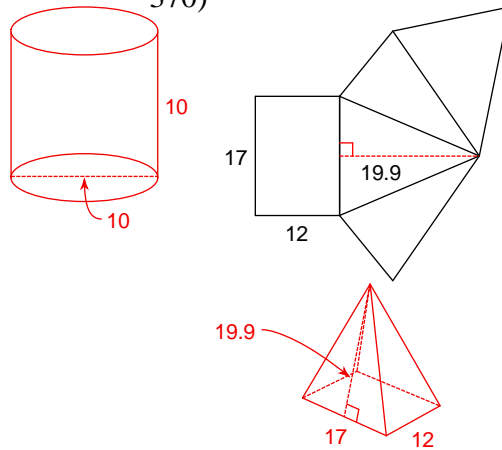

371)

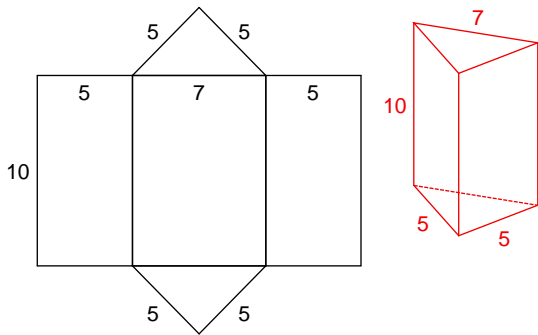

372)

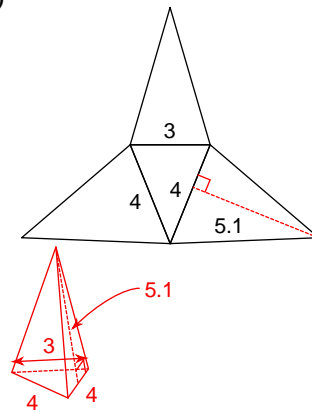

373)

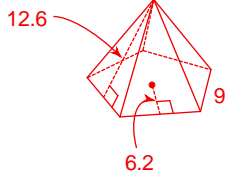
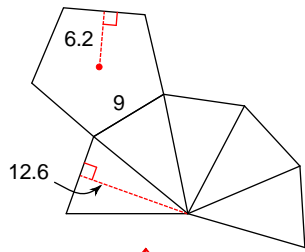

374)

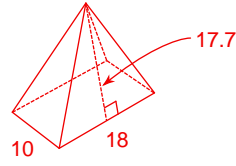
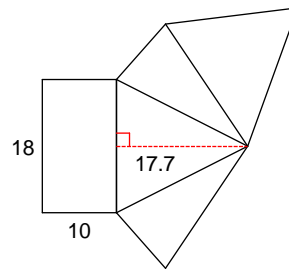

375)

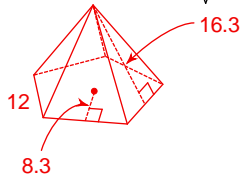
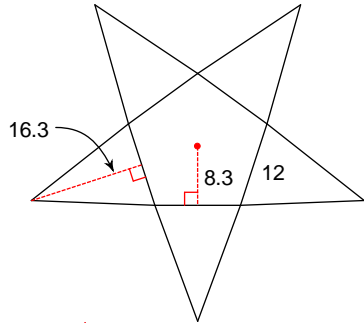

376)

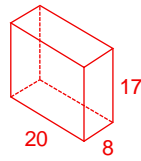
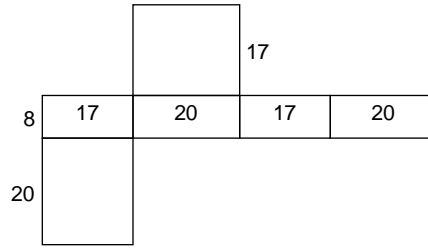

377)

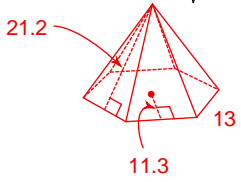
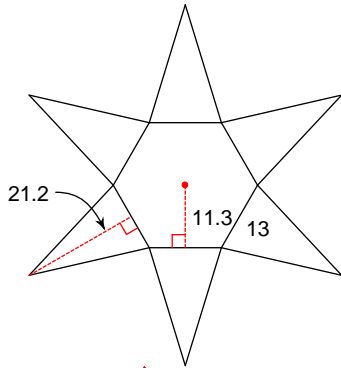

378)

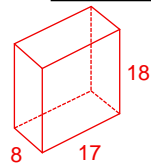
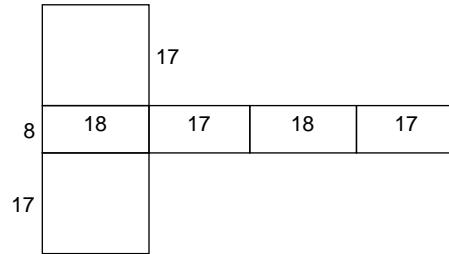

379)

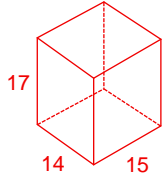
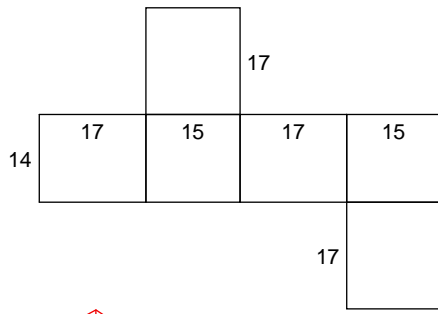

380)

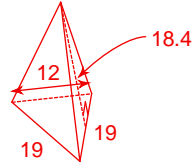
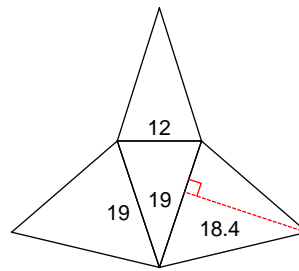

381)

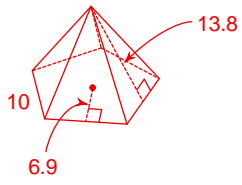
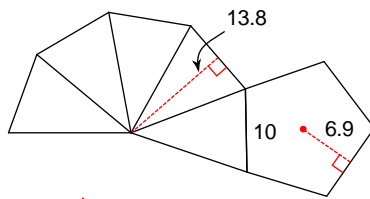

382)

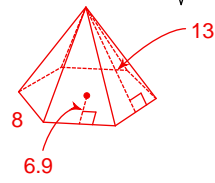
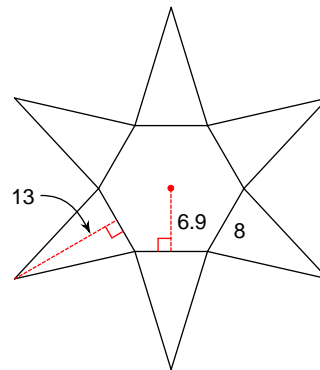

383)

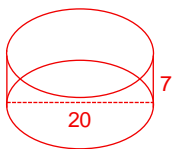
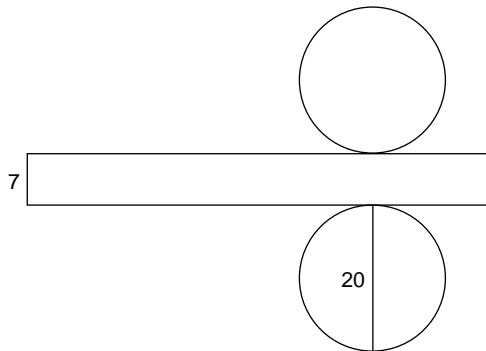

384)

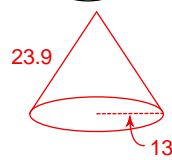
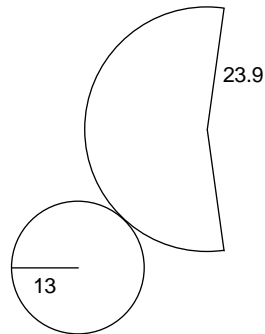

385)

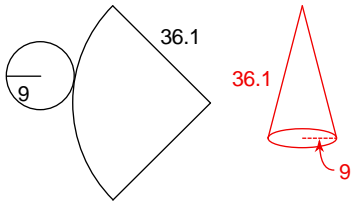

386)

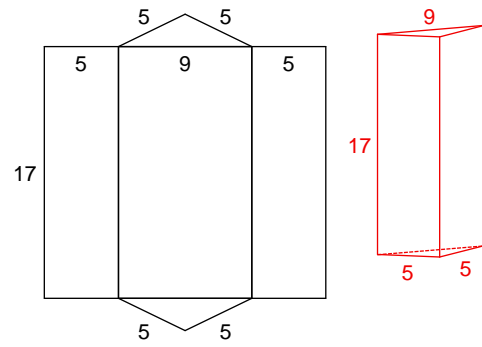

387)

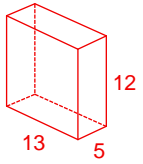
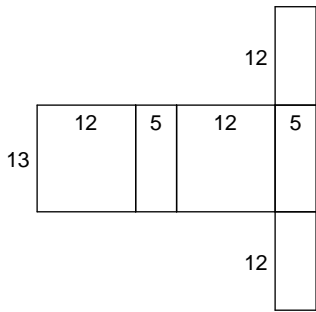

388)

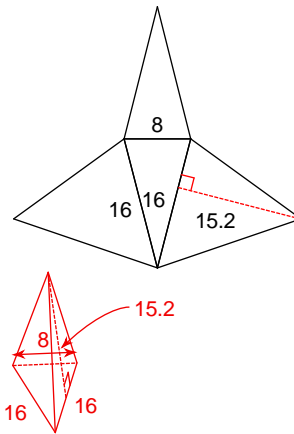

389)

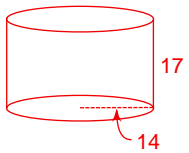
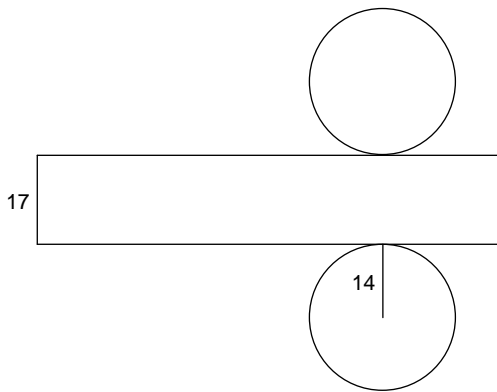

390)

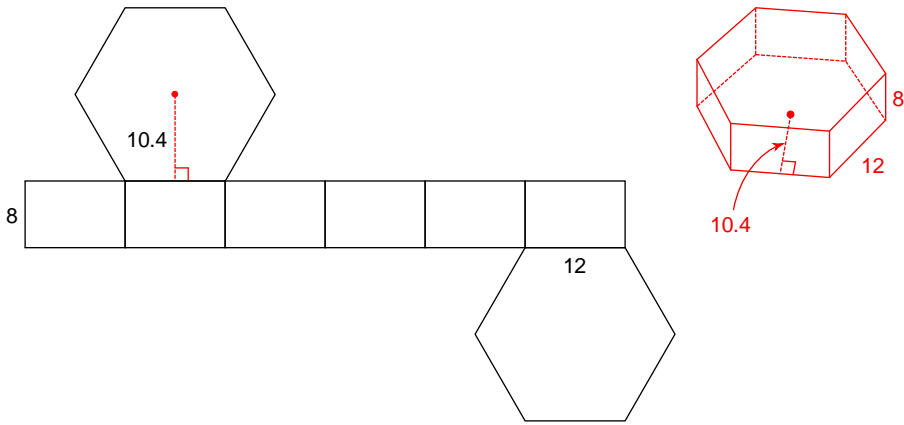

391)

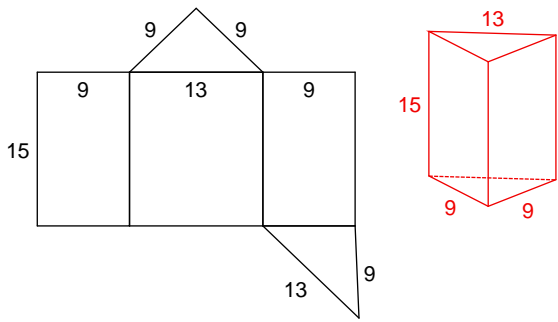

392)

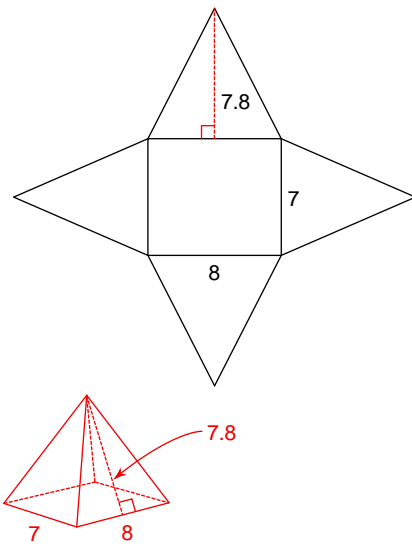

393)

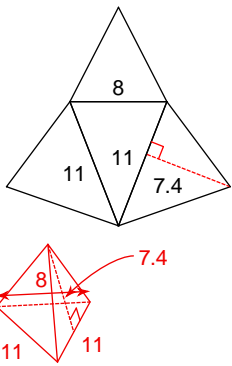

394)

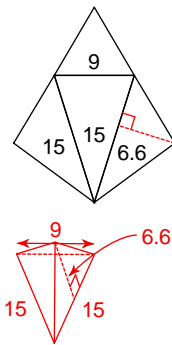

395)

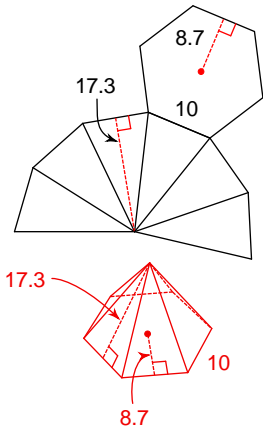

396)

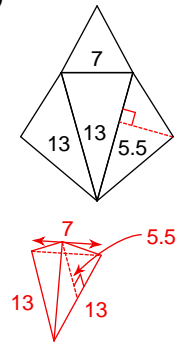

397)

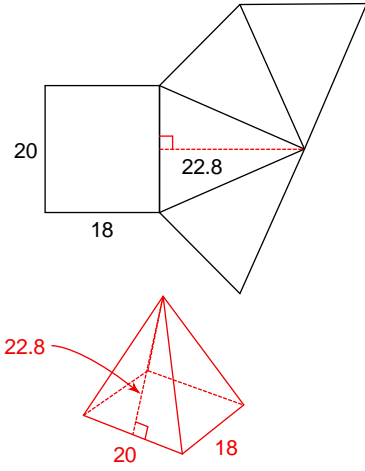

398)

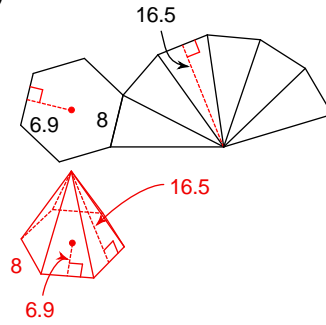

399)

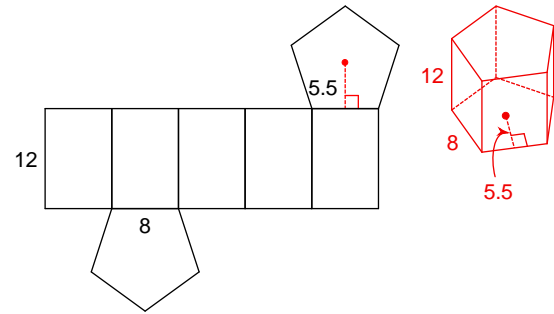

400)

