

Naming solid figures

Name the each prism considering number of sides and shape:

- 1) 
- 2) 
- 3) 
- 4) 
- 5) 
- 6) 
- 7) 
- 8) 
- 9) 
- 10) 

11)

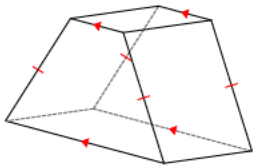
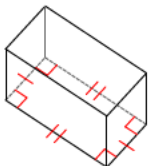
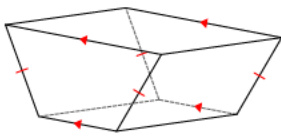
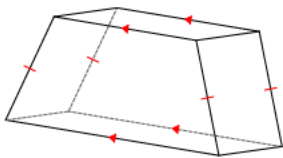
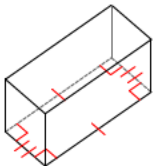
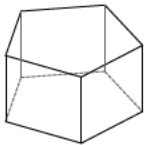
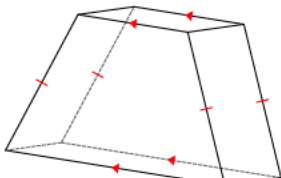
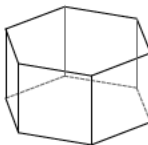
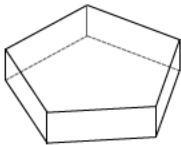
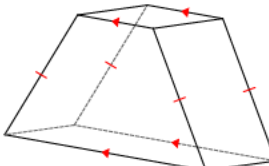
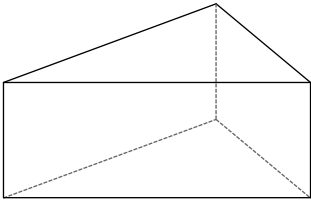

12)

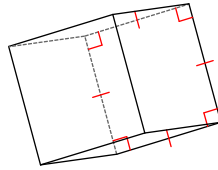

13)

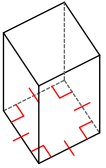

14)

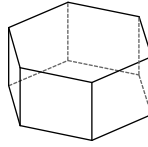

15)

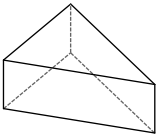

16)

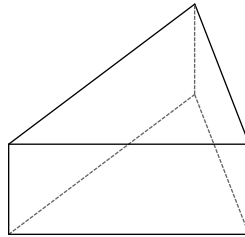

17)

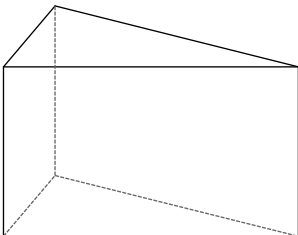

18)

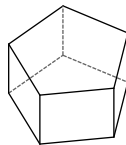

19)

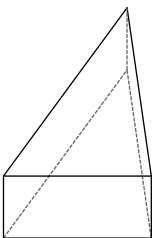

20)

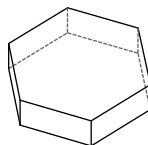

21)

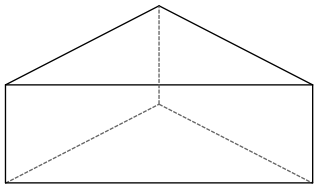

22)

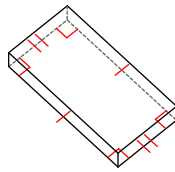

23)

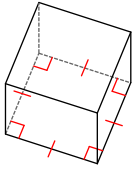

24)

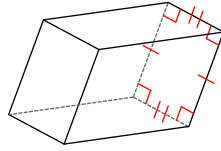

25)

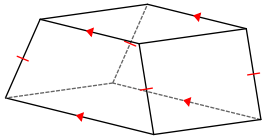

26)

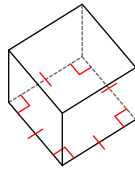

27)

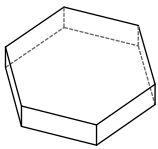

28)

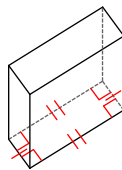

29)

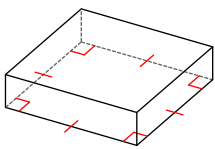

30)

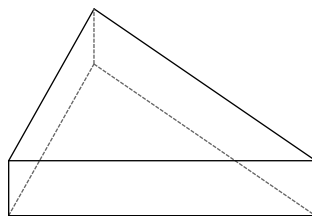

31)

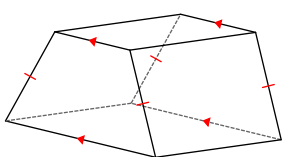

32)

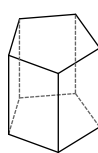

33)

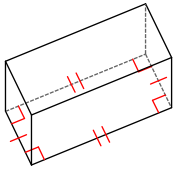

34)

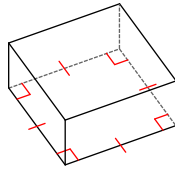

35)

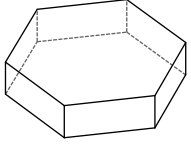

36)

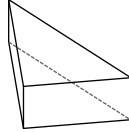

37)

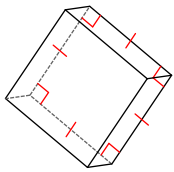

38)

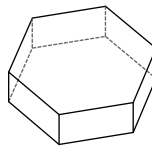

39)

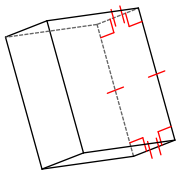

40)

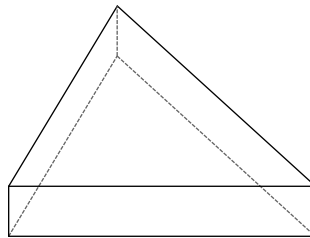

41)

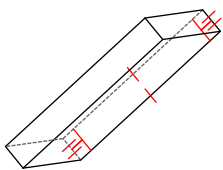

42)

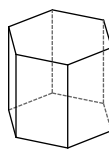

43)

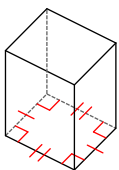

44)

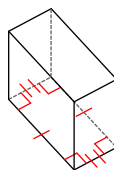

45)

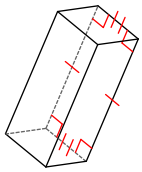

46)

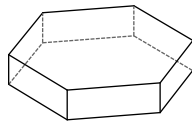

47)

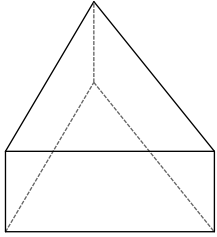

48)

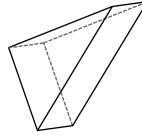

49)

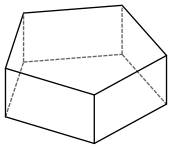

50)

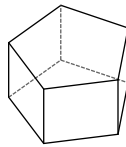

51)

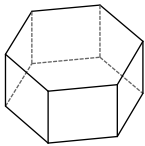

52)

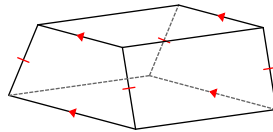

53)

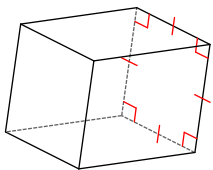

54)

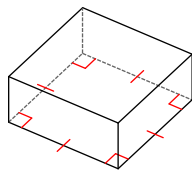

55)

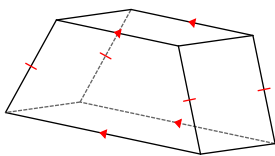

56)

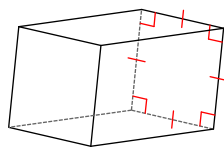

57)

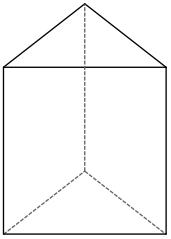

58)



59)

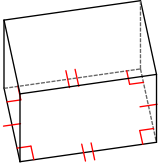

60)

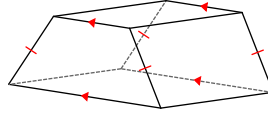

61)

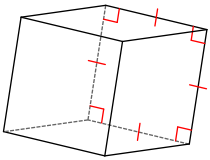

62)

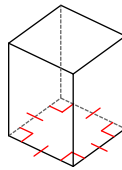

63)

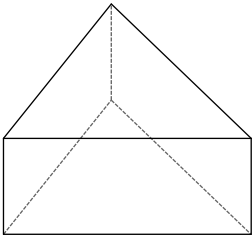

64)

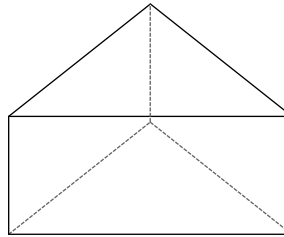

65)

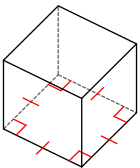

66)

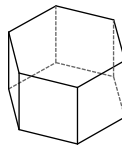

67)

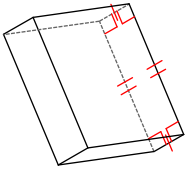

68)

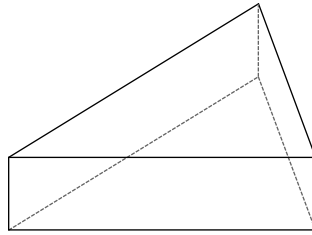

69)

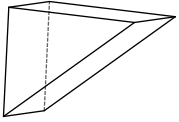

70)

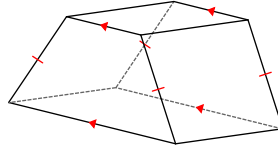

71)

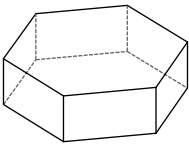

72)

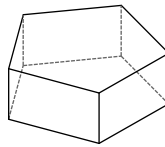

73)

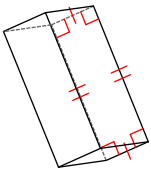

74)



75)

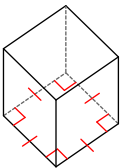

76)

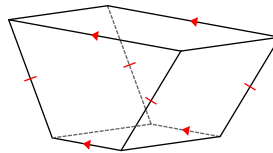

77)

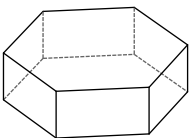

78)

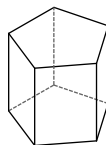

79)

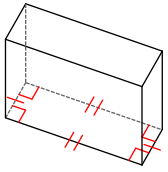

80)

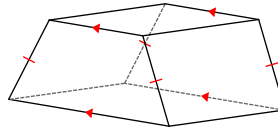

81)

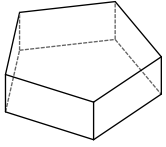

82)



83)

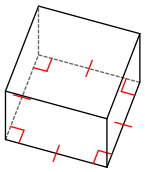

84)

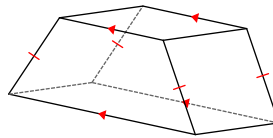

85)

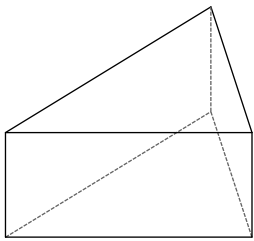

86)

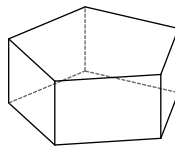

87)

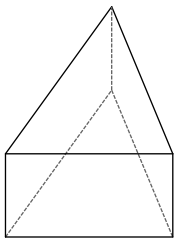

88)

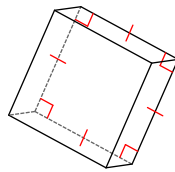

89)

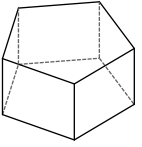

90)

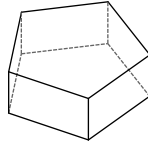

91)

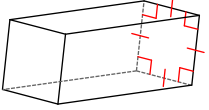

92)

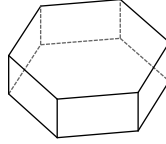

93)

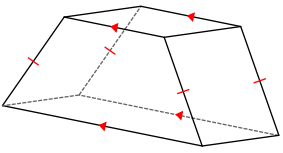

94)

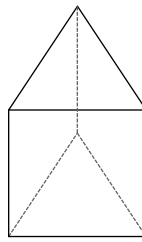

95)

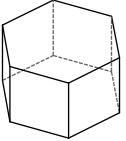

96)

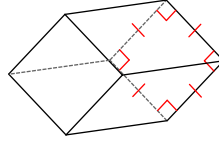

97)

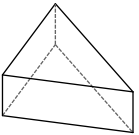

98)

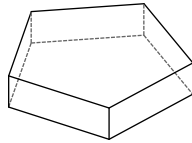

99)

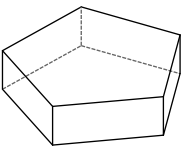

100)

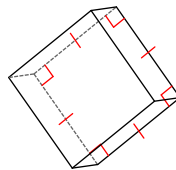

Name the each pyramid considering number of sides and shape:

101)

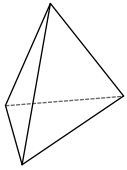

102)

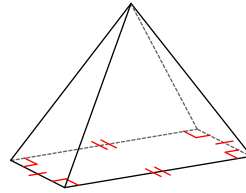

103)

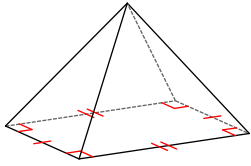

104)

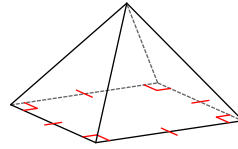

105)

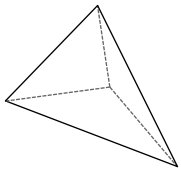

106)

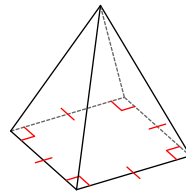

107)

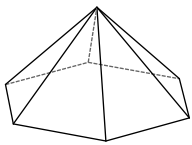

108)

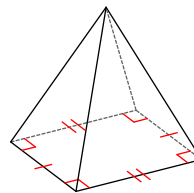

109)

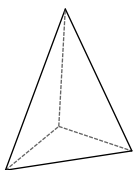

110)

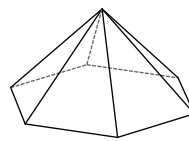

111)

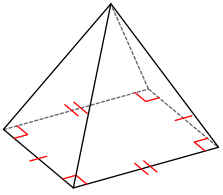

112)

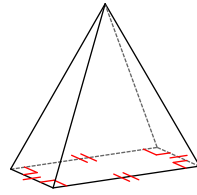

113)

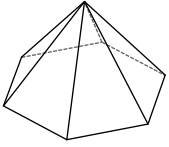

114)

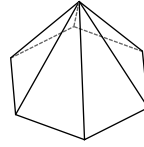

115)

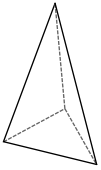

116)

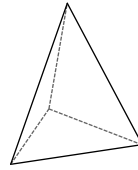

117)

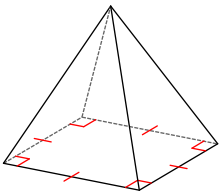

118)

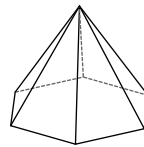

119)

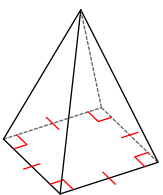

120)



121)

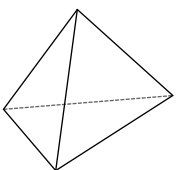

122)

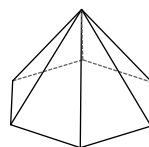

123)

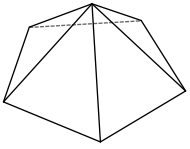

124)

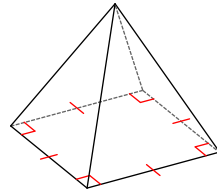

125)

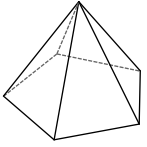

126)

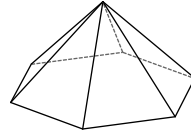

127)

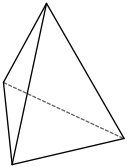

128)

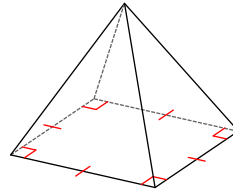

129)

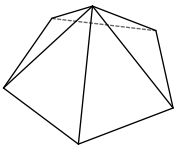

130)

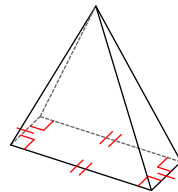

131)

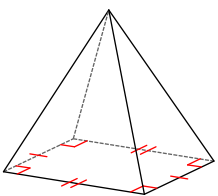

132)

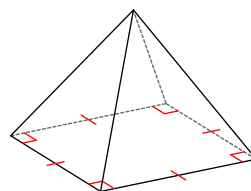

133)

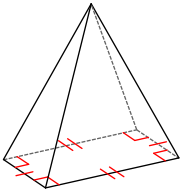

134)

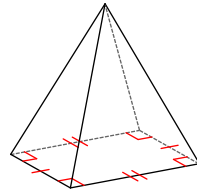

135)

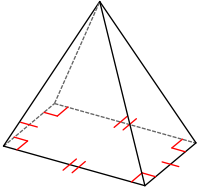

136)

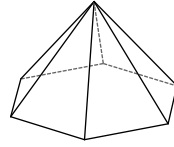

137)

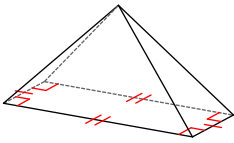

138)

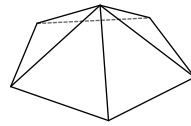

139)

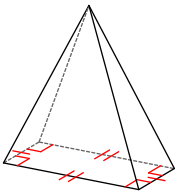

140)

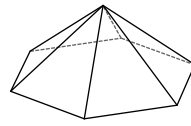

141)

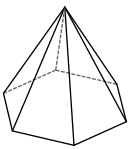

142)

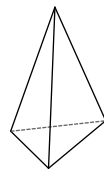

143)

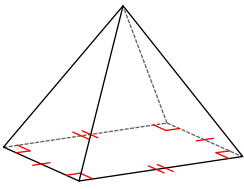

144)

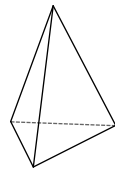

145)

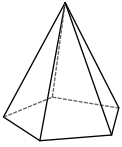

146)

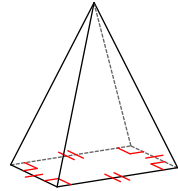

147)

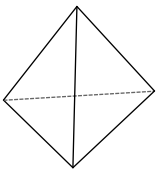

148)

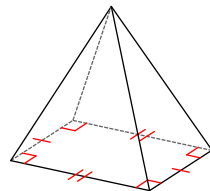

149)

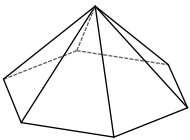

150)

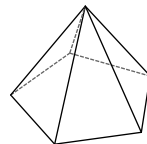

151)

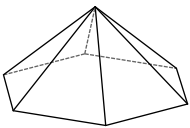

152)

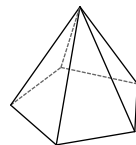

153)

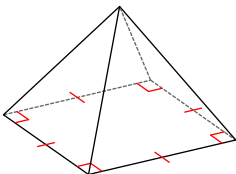

154)

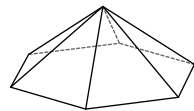

155)

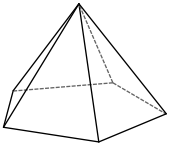

156)

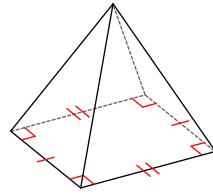

157)

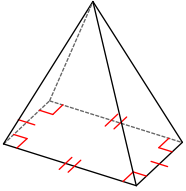

158)

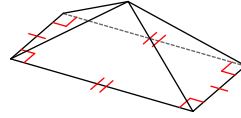

159)

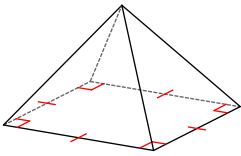

160)

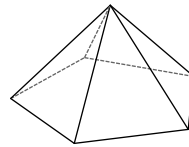

161)

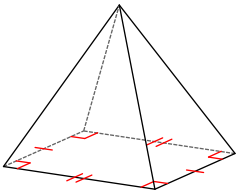

162)

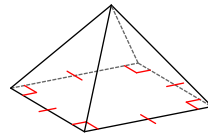

163)

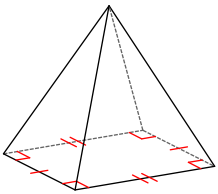

164)

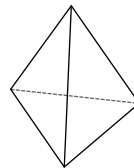

165)

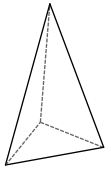

166)

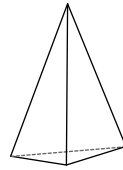

167)

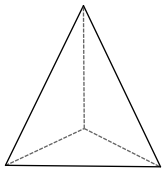

168)

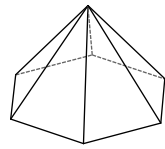

169)

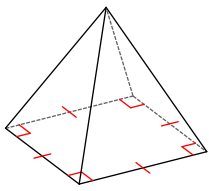

170)

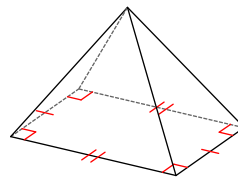

171)

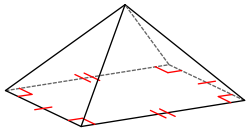

172)

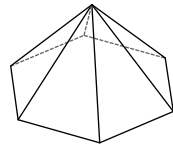

173)

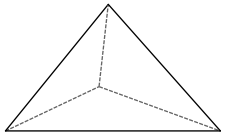

174)

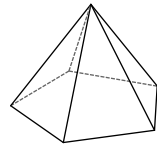

175)

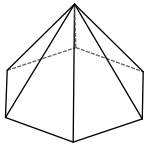

176)

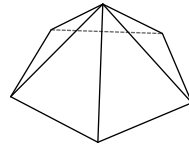

177)

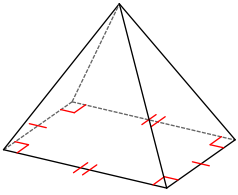

178)

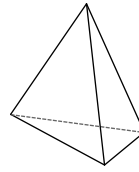

179)

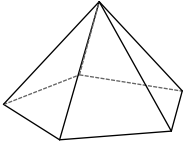

180)

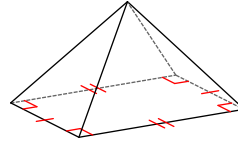

181)

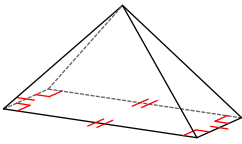

182)

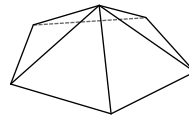

183)

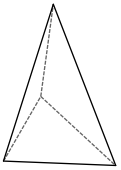

184)

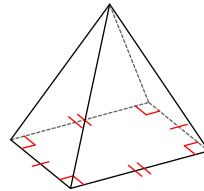

185)

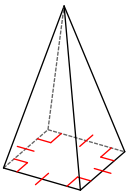

186)

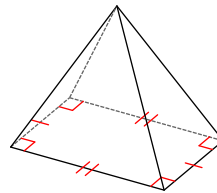

187)

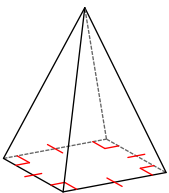

188)

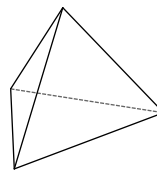

189)

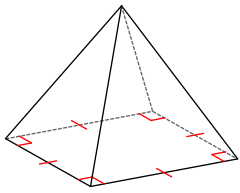

190)

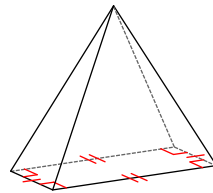

191)

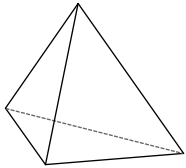

192)

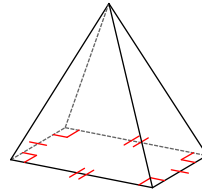

193)

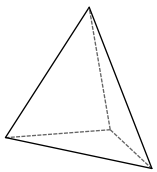

194)

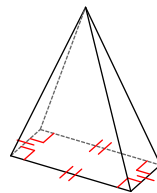

195)

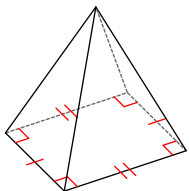

196)

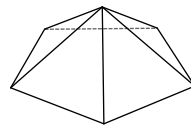

197)

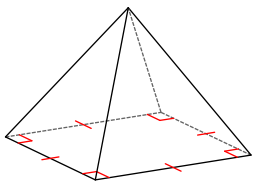

198)

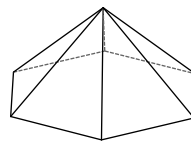

199)

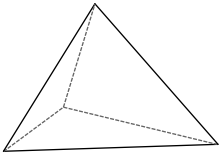

200)

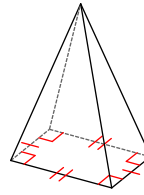

Name each figure considering number of sides and shape:

201)

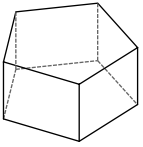

202)

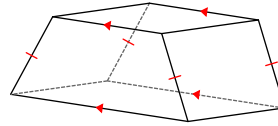

203)

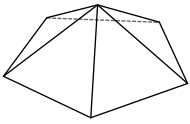

204)

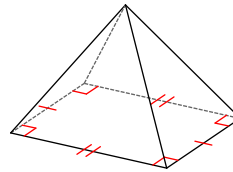

205)

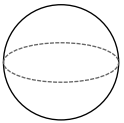

206)

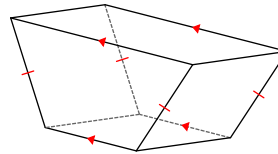

207)

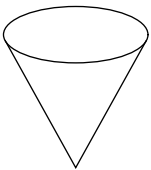

208)

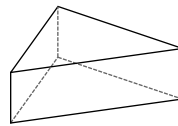

209)



210)

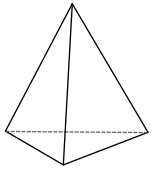

211)

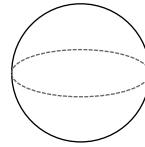

212)

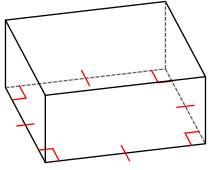

213)

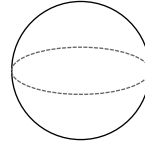

214)

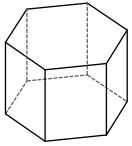

215)

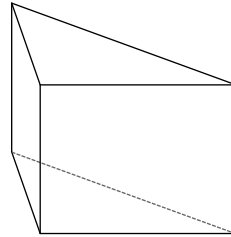

216)

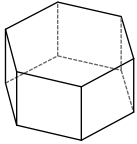

217)

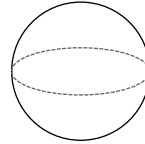

218)

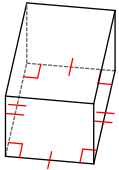

219)

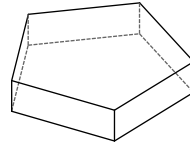

220)

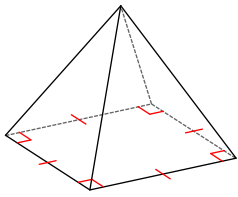

221)

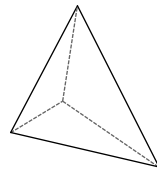

222)

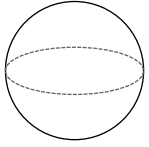

223)

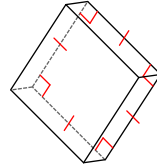

224)

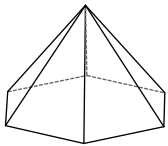

225)

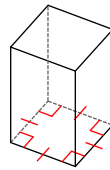

226)

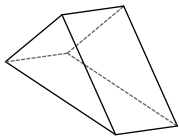

227)

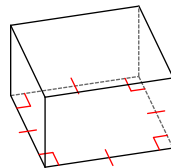

228)

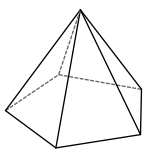

229)



230)

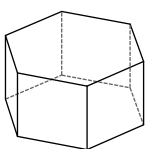

231)

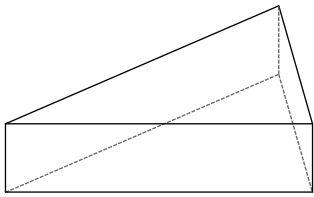

232)

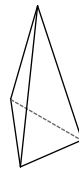

233)

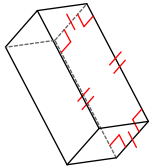

234)

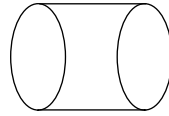

235)

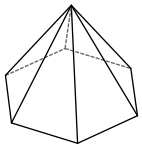

236)

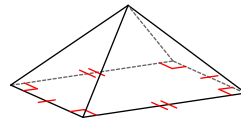

237)

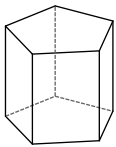

238)

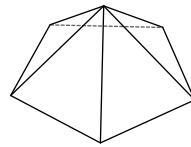

239)

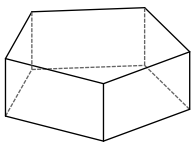

240)

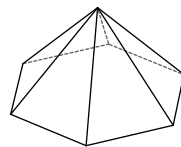

241)

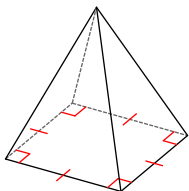

242)

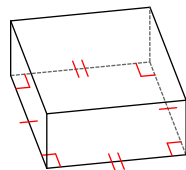

243)

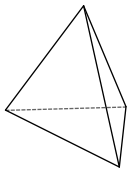

244)

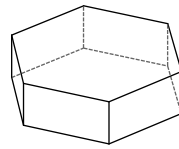

245)

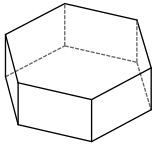

246)

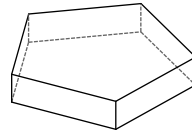

247)

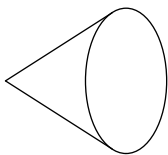

248)

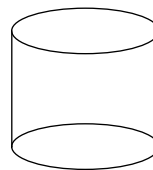

249)

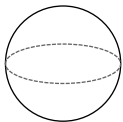

250)

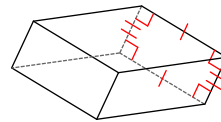

251)

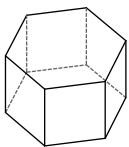

252)



253)

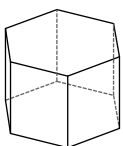

254)

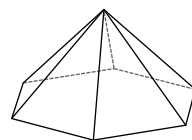

255)

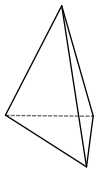

256)

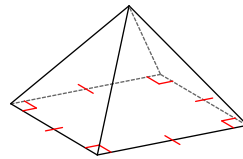

257)

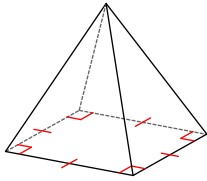

258)



259)

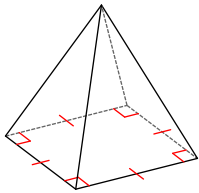

260)



261)

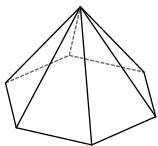

262)

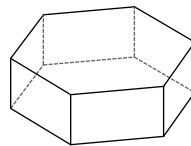

263)

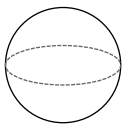

264)

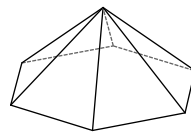

265)

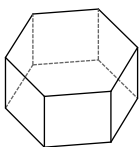

266)

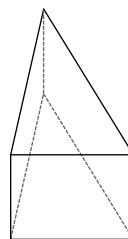

267)

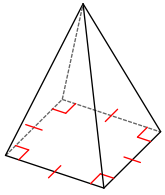

268)

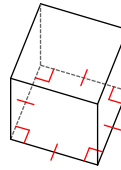

269)

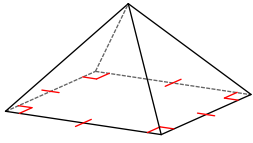

270)

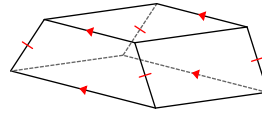

271)

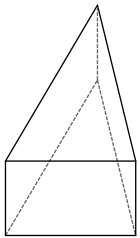

272)

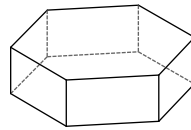

273)

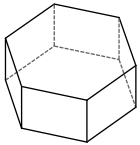

274)

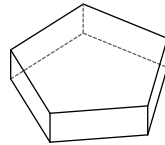

275)

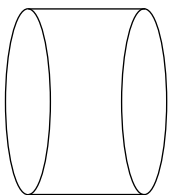

276)

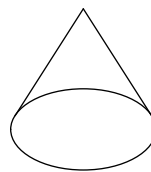

277)

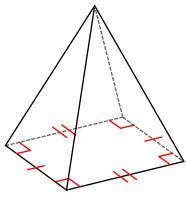

278)

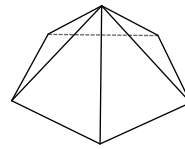

279)

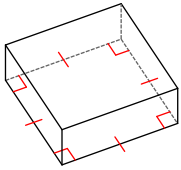

280)

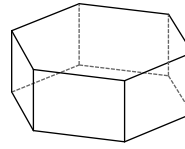

281)

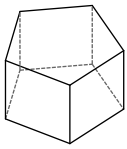

282)

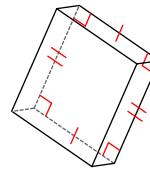

283)

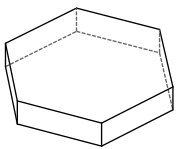

284)

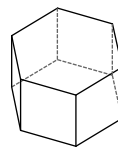

285)

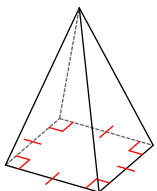

286)

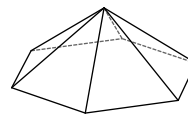

287)

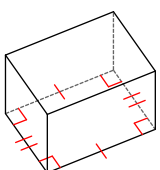

288)

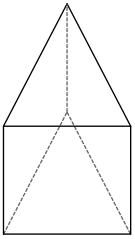

289)

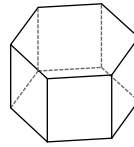

290)

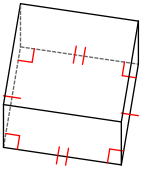

291)

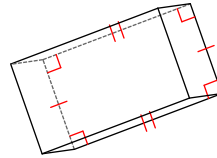

292)

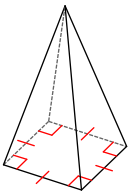

293)

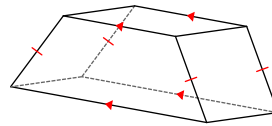

294)

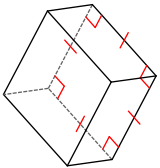

295)

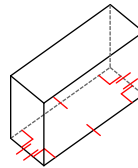

296)

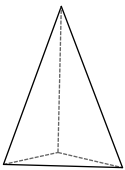

297)

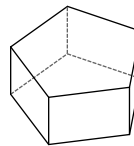

298)

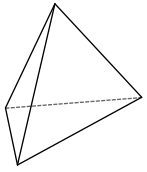

299)

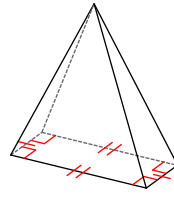

300)

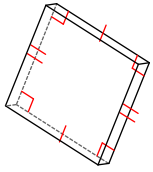

Naming solid figures

Name the each prism considering number of sides and shape:

1)

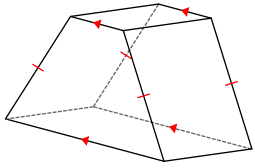

trapezoidal prism

2)

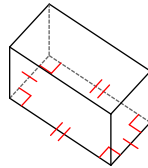

rectangular prism

3)

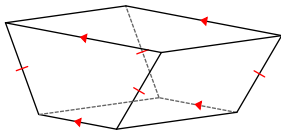

trapezoidal prism

4)

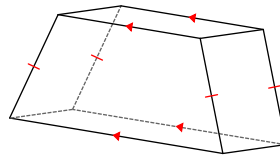

trapezoidal prism

5)

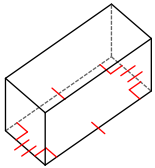

rectangular prism

6)

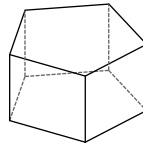

pentagonal prism

7)

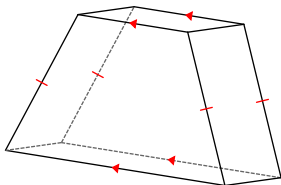

trapezoidal prism

8)

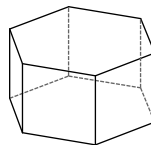

hexagonal prism

9)

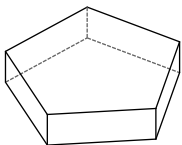

pentagonal prism

10)

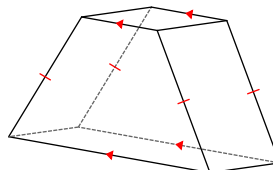

trapezoidal prism

11)

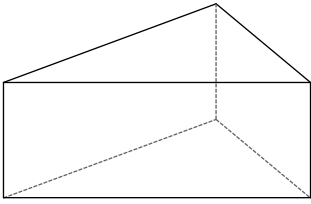

triangular prism

12)

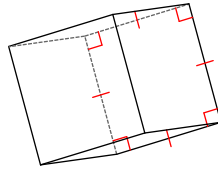

square prism

13)

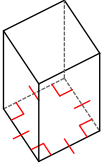

square prism

14)

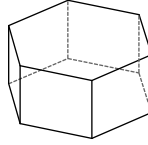

hexagonal prism

15)

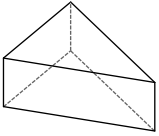

triangular prism

16)

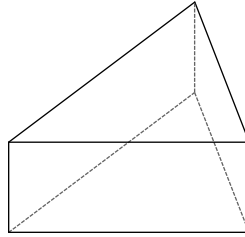

triangular prism

17)

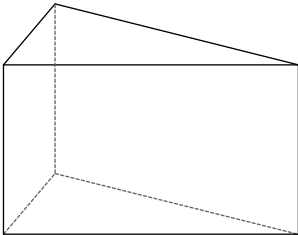

triangular prism

18)

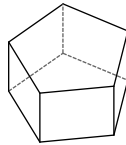

pentagonal prism

19)

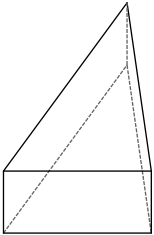

triangular prism

20)

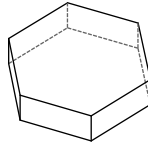

hexagonal prism

21)

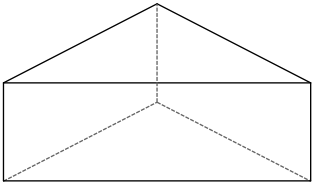

triangular prism

22)

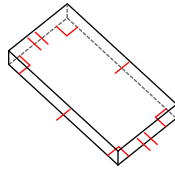

rectangular prism

23)

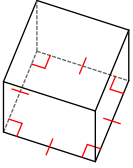

square prism

24)

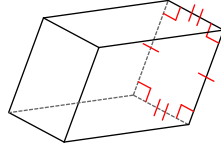

rectangular prism

25)

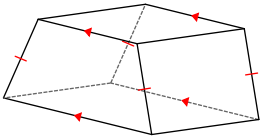

trapezoidal prism

26)

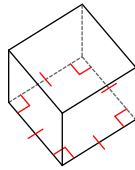

square prism

27)

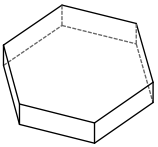

hexagonal prism

28)

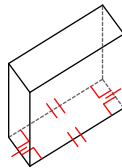

rectangular prism

29)

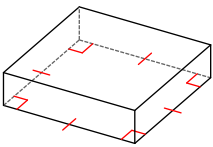

square prism

30)

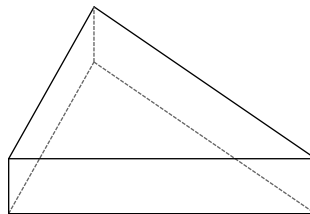

triangular prism

31)

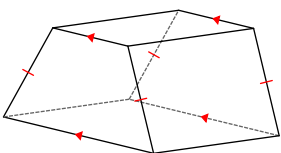

trapezoidal prism

32)

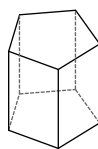

pentagonal prism

33)

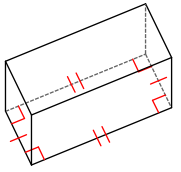

rectangular prism

34)

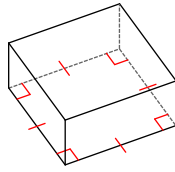

square prism

35)

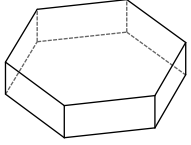

hexagonal prism

36)

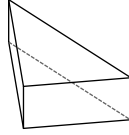

triangular prism

37)

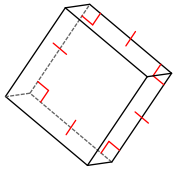

square prism

38)

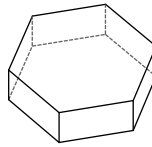

hexagonal prism

39)

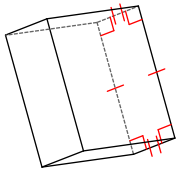

rectangular prism

40)

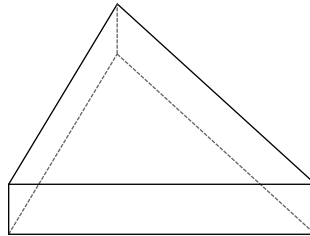

triangular prism

41)

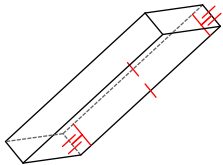

rectangular prism

42)

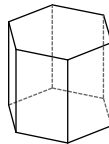

hexagonal prism

43)

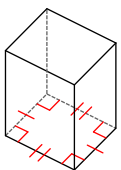

rectangular prism

44)

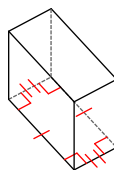

rectangular prism

45)

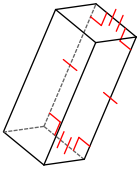

rectangular prism

46)

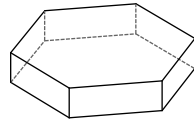

hexagonal prism

47)

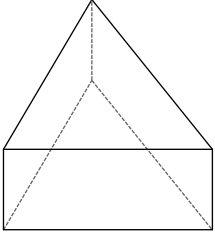

triangular prism

48)

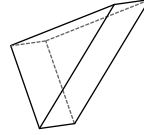

triangular prism

49)

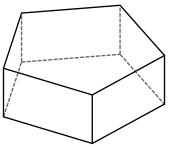

pentagonal prism

50)

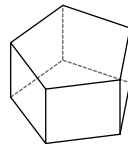

pentagonal prism

51)

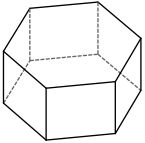

hexagonal prism

52)

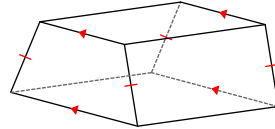

trapezoidal prism

53)

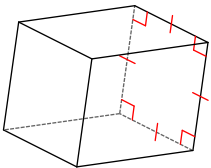

square prism

54)

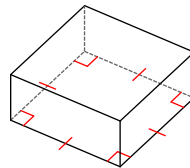

square prism

55)

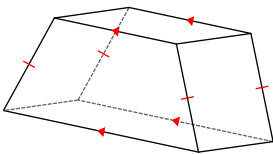

trapezoidal prism

56)

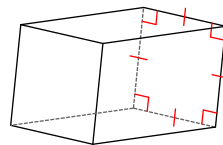

square prism

57)

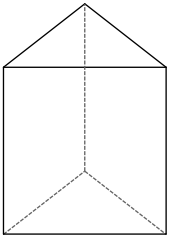

triangular prism

58)



rectangular prism

59)

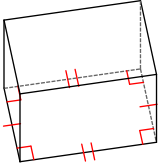

rectangular prism

60)

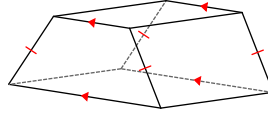

trapezoidal prism

61)

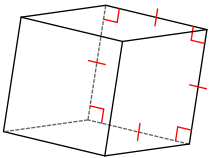

square prism

62)

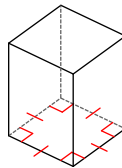

square prism

63)

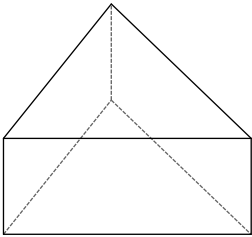

triangular prism

64)

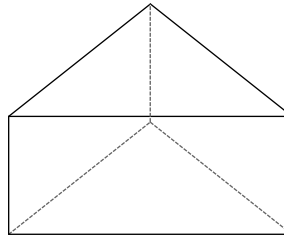

triangular prism

65)

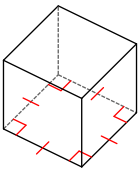

square prism

66)

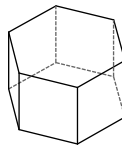

hexagonal prism

67)

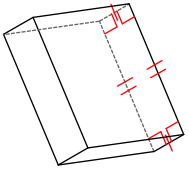

rectangular prism

68)

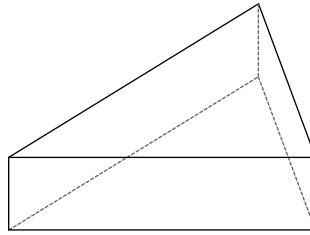

triangular prism

69)

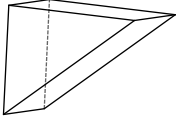

triangular prism

70)

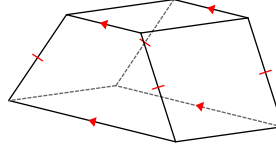

trapezoidal prism

71)

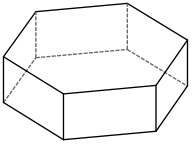

hexagonal prism

72)

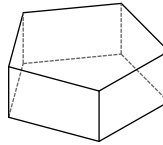

pentagonal prism

73)

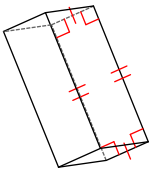

rectangular prism

74)



rectangular prism

75)

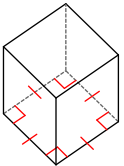

square prism

76)

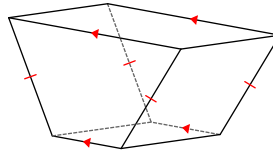

trapezoidal prism

77)

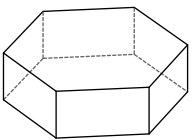

hexagonal prism

78)

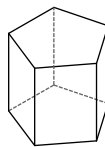

pentagonal prism

79)

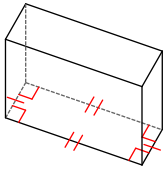

rectangular prism

80)

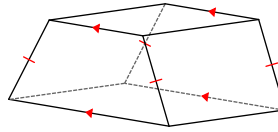

trapezoidal prism

81)

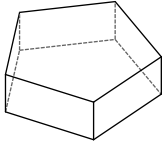

pentagonal prism

82)

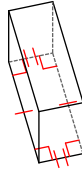

rectangular prism

83)

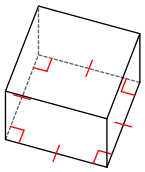

square prism

84)

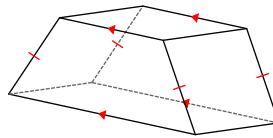

trapezoidal prism

85)

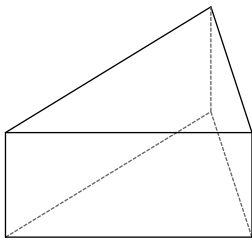

triangular prism

86)

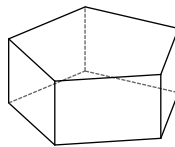

pentagonal prism

87)

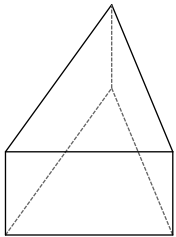

triangular prism

88)

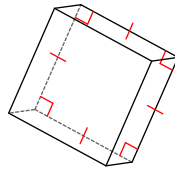

square prism

89)

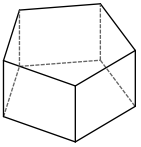

pentagonal prism

90)

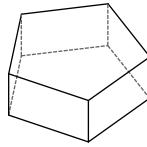

pentagonal prism

91)

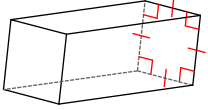

square prism

92)

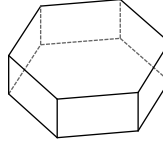

hexagonal prism

93)

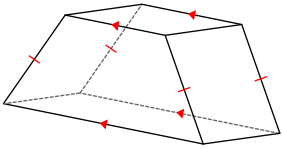

trapezoidal prism

94)

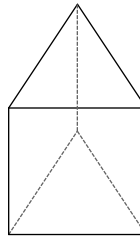

triangular prism

95)

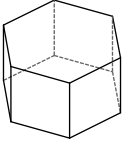

hexagonal prism

96)

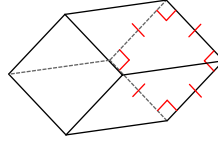

square prism

97)

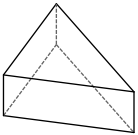

triangular prism

98)

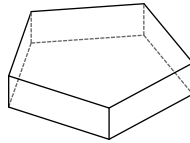

pentagonal prism

99)

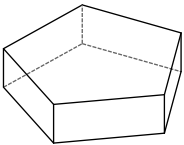

pentagonal prism

100)

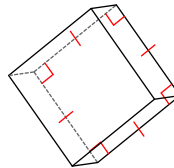

square prism

Name the each pyramid considering number of sides and shape:

101)

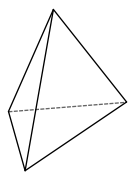

triangular pyramid

102)

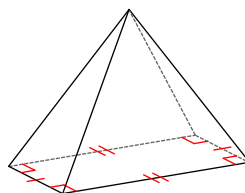

rectangular pyramid

103)

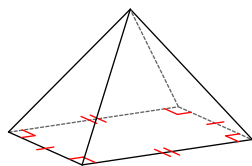

rectangular pyramid

104)

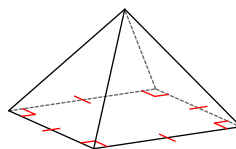

square pyramid

105)

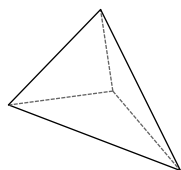

triangular pyramid

106)

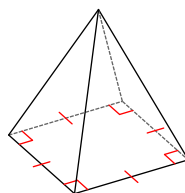

square pyramid

107)

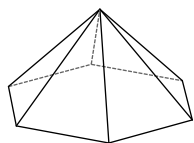

hexagonal pyramid

108)

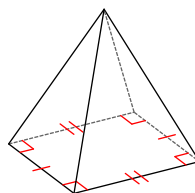

rectangular pyramid

109)

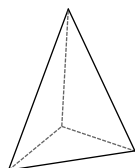

triangular pyramid

110)

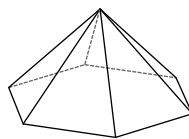

hexagonal pyramid

111)

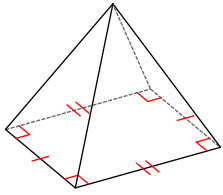

rectangular pyramid

112)

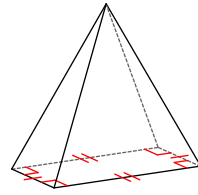

rectangular pyramid

113)

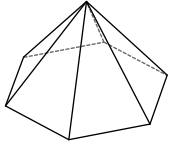

hexagonal pyramid

114)

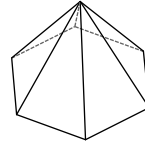

hexagonal pyramid

115)

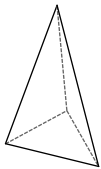

triangular pyramid

116)

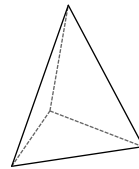

triangular pyramid

117)

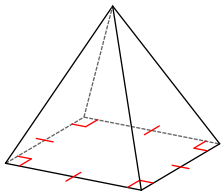

square pyramid

118)

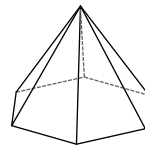

hexagonal pyramid

119)

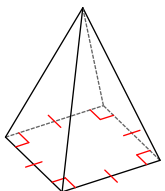

square pyramid

120)



triangular pyramid

121)

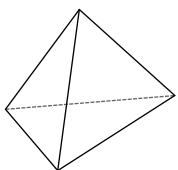

triangular pyramid

122)

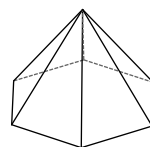

hexagonal pyramid

123)

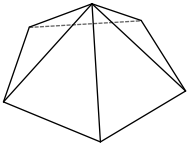

pentagonal pyramid

124)

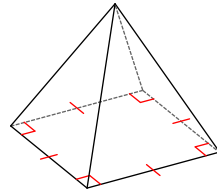

square pyramid

125)

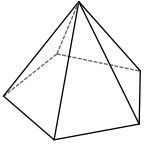

pentagonal pyramid

126)

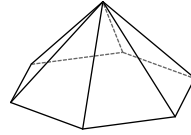

hexagonal pyramid

127)

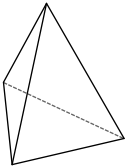

triangular pyramid

128)

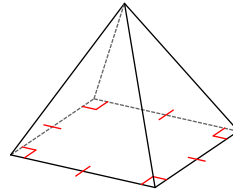

square pyramid

129)

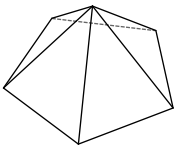

pentagonal pyramid

130)

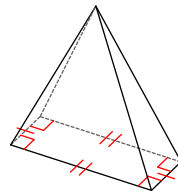

rectangular pyramid

131)

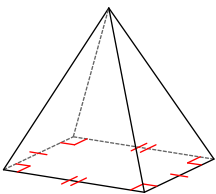

rectangular pyramid

132)

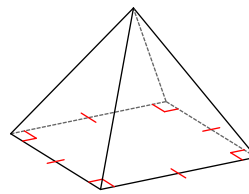

square pyramid

133)

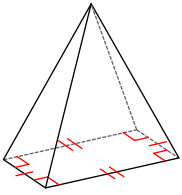

rectangular pyramid

134)

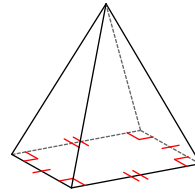

rectangular pyramid

135)

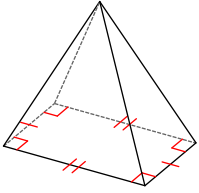

rectangular pyramid

136)

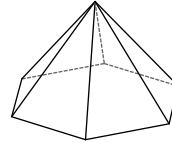

hexagonal pyramid

137)

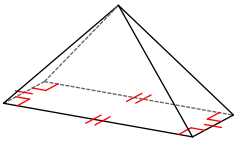

rectangular pyramid

138)

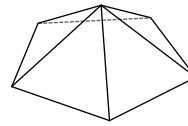

pentagonal pyramid

139)

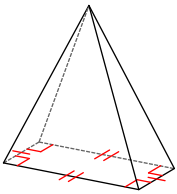

rectangular pyramid

140)

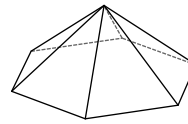

hexagonal pyramid

141)

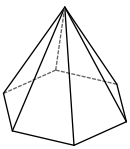

hexagonal pyramid

142)



triangular pyramid

143)

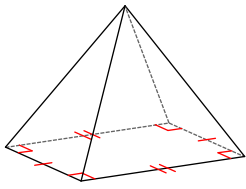

rectangular pyramid

144)

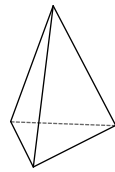

triangular pyramid

145)

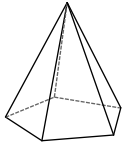

pentagonal pyramid

146)

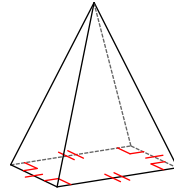

rectangular pyramid

147)

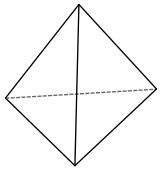

triangular pyramid

148)

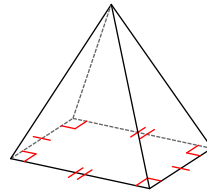

rectangular pyramid

149)

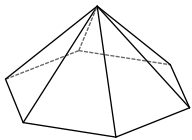

hexagonal pyramid

150)

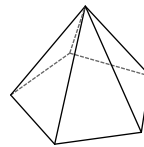

pentagonal pyramid

151)

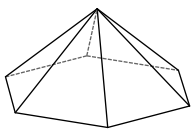

hexagonal pyramid

152)

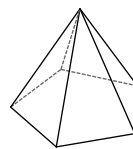

pentagonal pyramid

153)

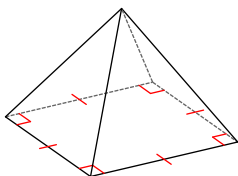

square pyramid

154)

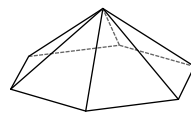

hexagonal pyramid

155)

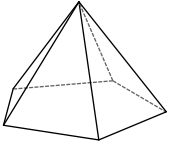

pentagonal pyramid

156)

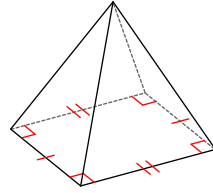

rectangular pyramid

157)

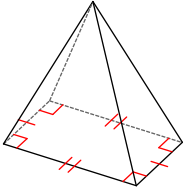

rectangular pyramid

158)

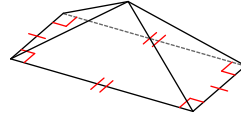

rectangular pyramid

159)

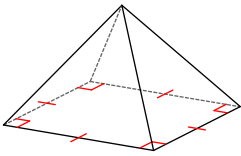

square pyramid

160)

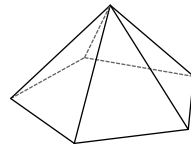

pentagonal pyramid

161)

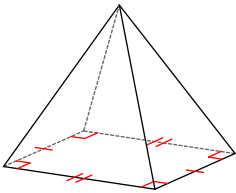

rectangular pyramid

162)

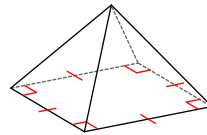

square pyramid

163)

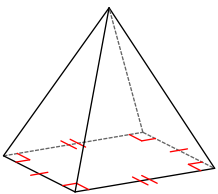

rectangular pyramid

164)

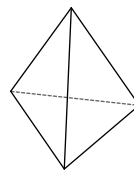

triangular pyramid

165)

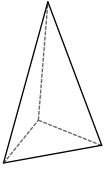

triangular pyramid

166)

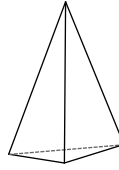

triangular pyramid

167)

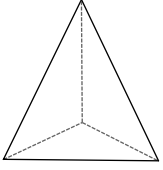

triangular pyramid

168)

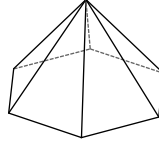

hexagonal pyramid

169)

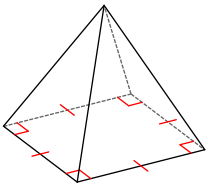

square pyramid

170)

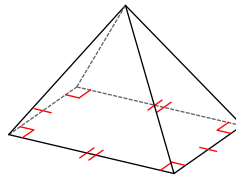

rectangular pyramid

171)

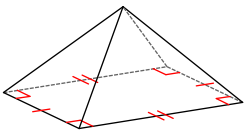

rectangular pyramid

172)

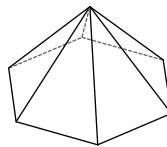

hexagonal pyramid

173)

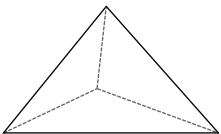

triangular pyramid

174)

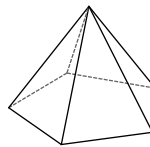

pentagonal pyramid

175)

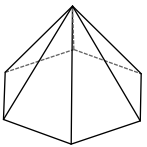

hexagonal pyramid

176)

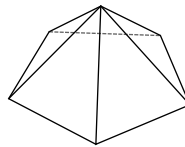

pentagonal pyramid

177)

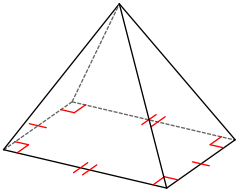

rectangular pyramid

178)

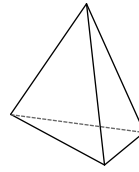

triangular pyramid

179)

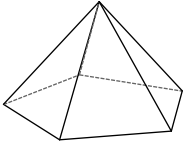

pentagonal pyramid

180)

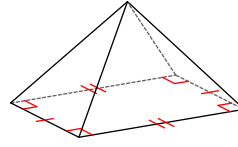

rectangular pyramid

181)

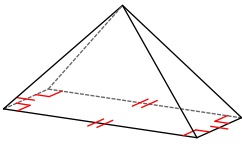

rectangular pyramid

182)

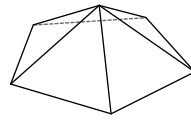

pentagonal pyramid

183)

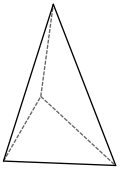

triangular pyramid

184)

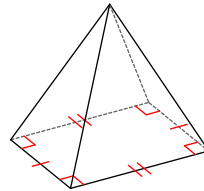

rectangular pyramid

185)

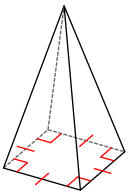

square pyramid

186)

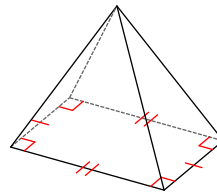

rectangular pyramid

187)

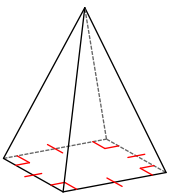

square pyramid

188)

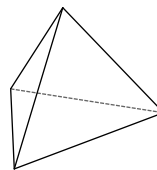

triangular pyramid

189)

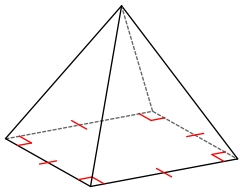

square pyramid

190)

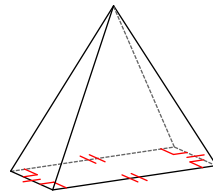

rectangular pyramid

191)

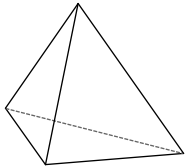

triangular pyramid

192)

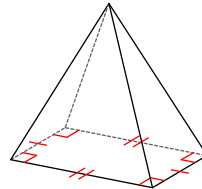

rectangular pyramid

193)

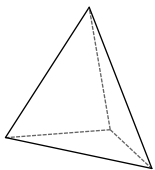

triangular pyramid

194)

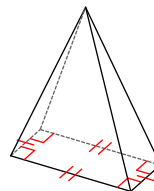

rectangular pyramid

195)

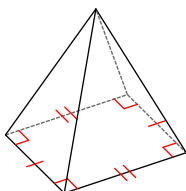

rectangular pyramid

196)

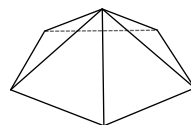

pentagonal pyramid

197)

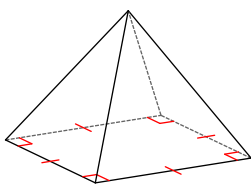

square pyramid

198)

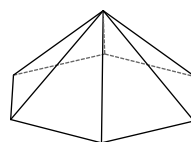

hexagonal pyramid

199)

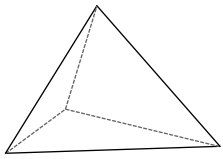

triangular pyramid

200)

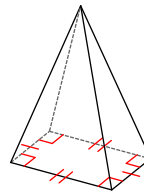

rectangular pyramid

Name each figure considering number of sides and shape:

201)

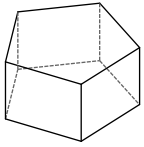

pentagonal prism

202)

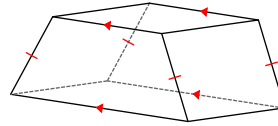

trapezoidal prism

203)

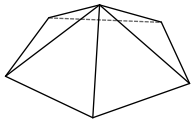

pentagonal pyramid

204)

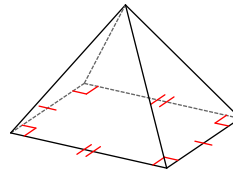

rectangular pyramid

205)

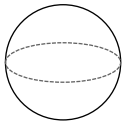

sphere

206)

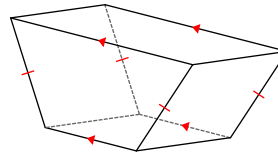

trapezoidal prism

207)

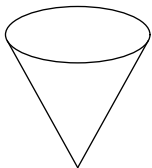

cone

208)

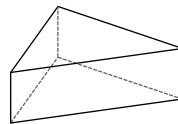

triangular prism

209)



cylinder

210)

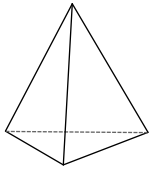

triangular pyramid

211)

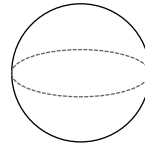

sphere

212)

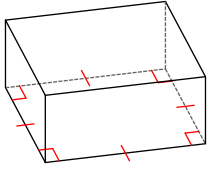

square prism

213)

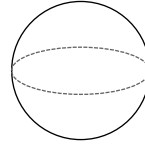

sphere

214)

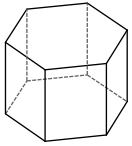

hexagonal prism

215)

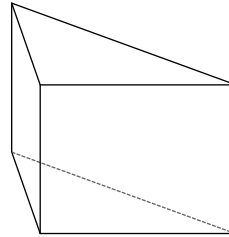

triangular prism

216)

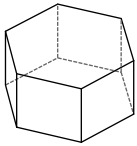

hexagonal prism

217)

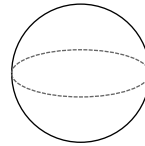

sphere

218)

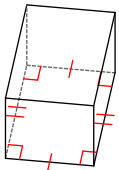

rectangular prism

219)

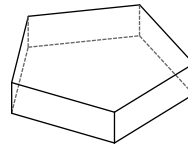

pentagonal prism

220)

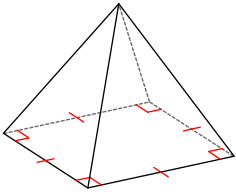

square pyramid

221)

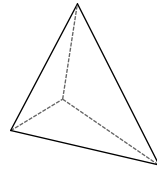

triangular pyramid

222)

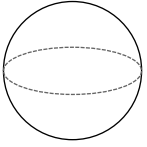

sphere

223)

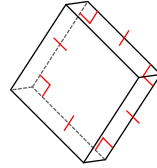

square prism

224)

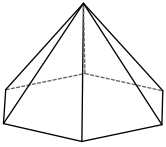

hexagonal pyramid

225)

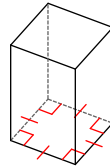

square prism

226)

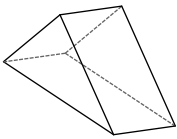

triangular prism

227)

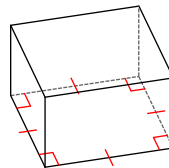

square prism

228)

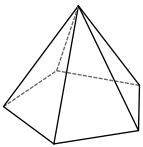

pentagonal pyramid

229)



triangular pyramid

230)

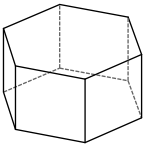

hexagonal prism

231)

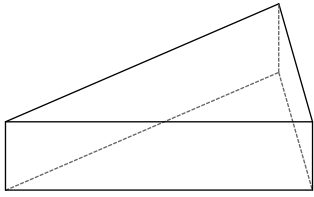

triangular prism

232)

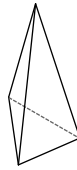

triangular pyramid

233)

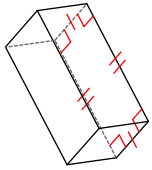

rectangular prism

234)

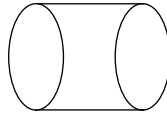

cylinder

235)

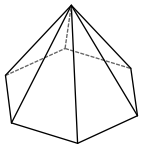

hexagonal pyramid

236)

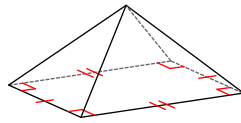

rectangular pyramid

237)

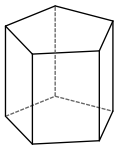

pentagonal prism

238)

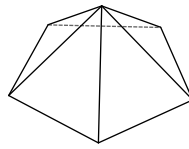

pentagonal pyramid

239)

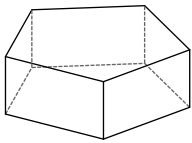

pentagonal prism

240)

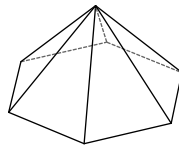

hexagonal pyramid

241)

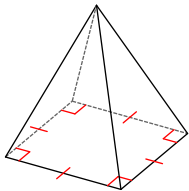

square pyramid

242)

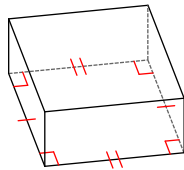

rectangular prism

243)

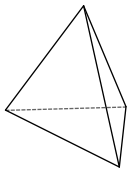

triangular pyramid

244)

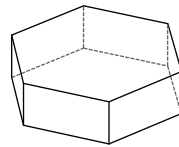

hexagonal prism

245)

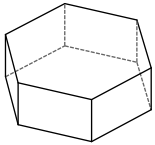

hexagonal prism

246)

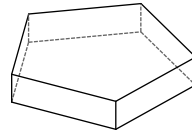

pentagonal prism

247)

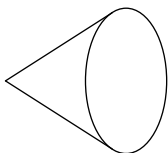

cone

248)

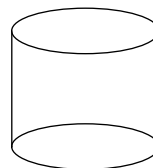

cylinder

249)

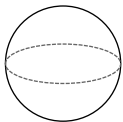

sphere

250)

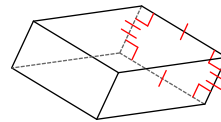

rectangular prism

251)

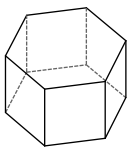

hexagonal prism

252)



cone

253)

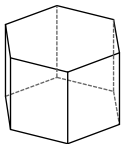

hexagonal prism

254)

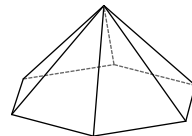

hexagonal pyramid

255)

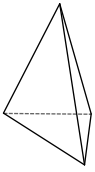

triangular pyramid

256)

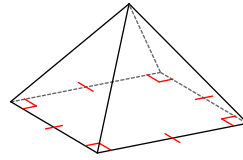

square pyramid

257)

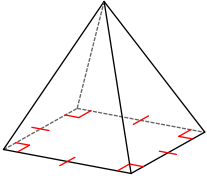

square pyramid

258)



cone

259)

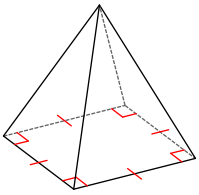

square pyramid

260)



cone

261)

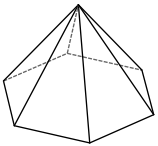

hexagonal pyramid

262)

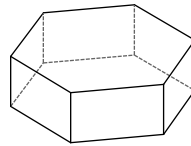

hexagonal prism

263)

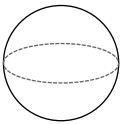

sphere

264)

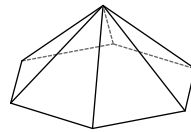

hexagonal pyramid

265)

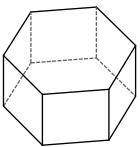

hexagonal prism

266)

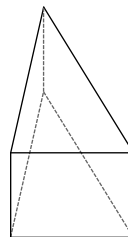

triangular prism

267)

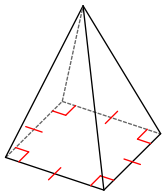

square pyramid

268)

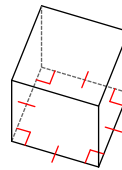

square prism

269)

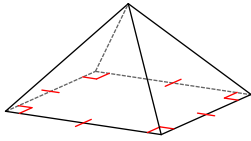

square pyramid

270)

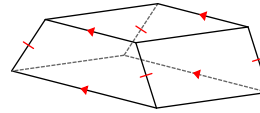

trapezoidal prism

271)

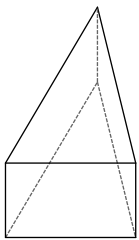

triangular prism

272)

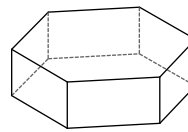

hexagonal prism

273)

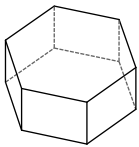

hexagonal prism

274)

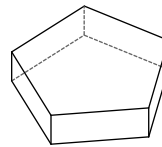

pentagonal prism

275)

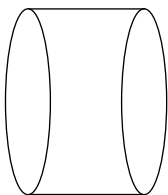

cylinder

276)

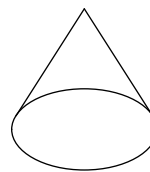

cone

277)

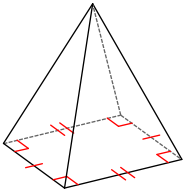

rectangular pyramid

278)

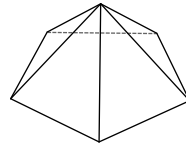

pentagonal pyramid

279)

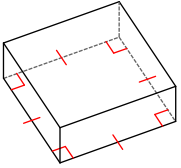

square prism

280)

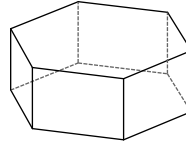

hexagonal prism

281)

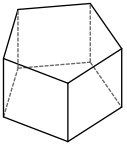

pentagonal prism

282)

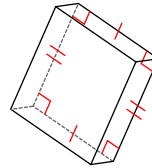

rectangular prism

283)

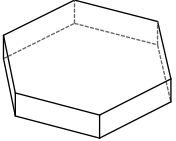

hexagonal prism

284)

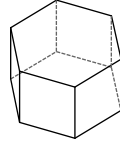

hexagonal prism

285)

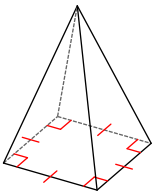

square pyramid

286)

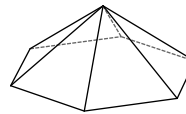

hexagonal pyramid

287)

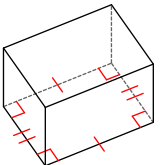

rectangular prism

288)

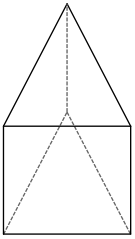

triangular prism

289)

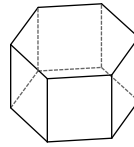

hexagonal prism

290)

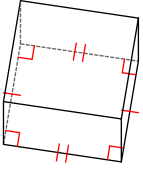

rectangular prism

291)

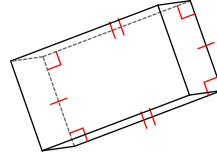

rectangular prism

292)

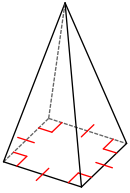

square pyramid

293)

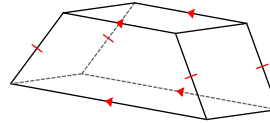

trapezoidal prism

294)

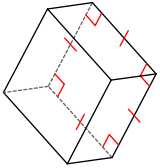

square prism

295)

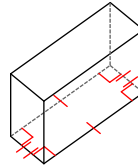

rectangular prism

296)

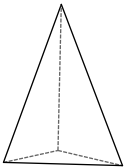

triangular pyramid

297)

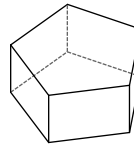

pentagonal prism

298)

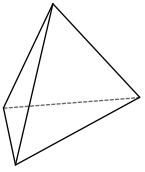

triangular pyramid

299)

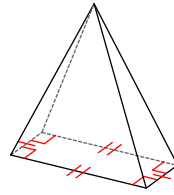

rectangular pyramid

300)

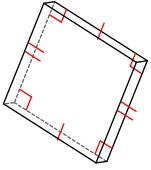

rectangular prism