

## Right triangles - The Pythagorean Theorem - Radicals

Find the missing side of triangle:

1)

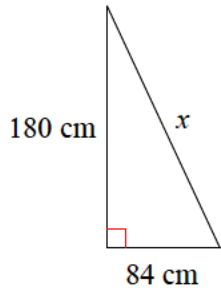

2)

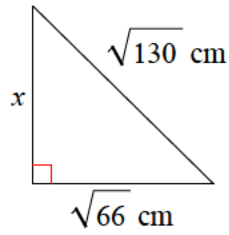

3)

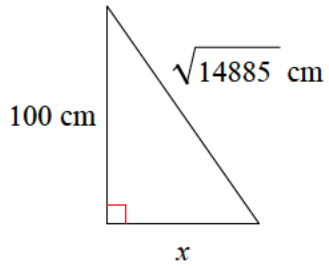

4)

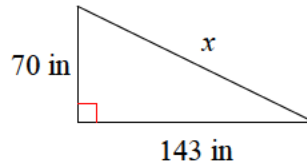

5)

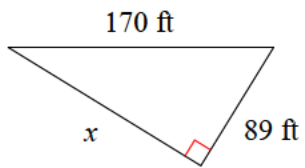

6)

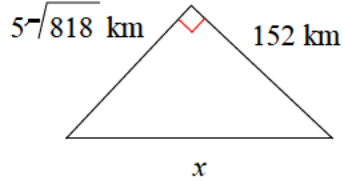

7)

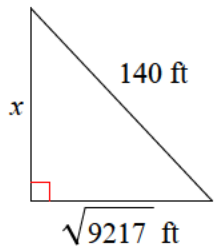

8)

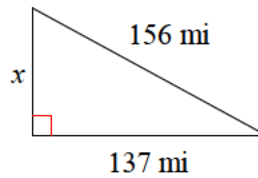

9)

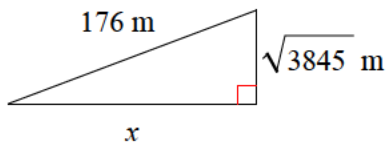

10)

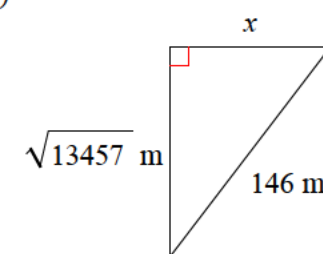

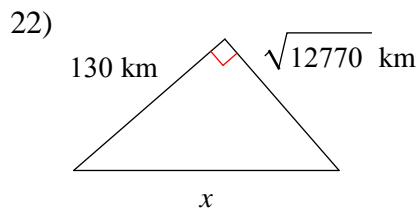
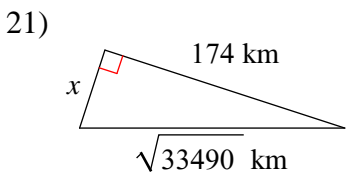
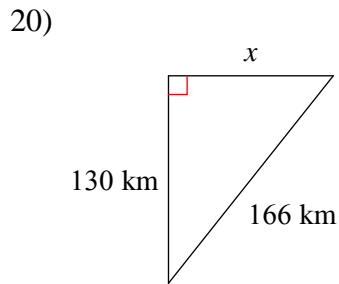
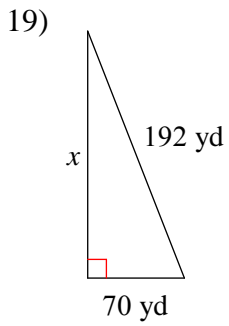
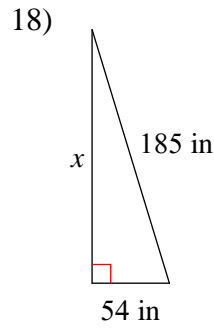
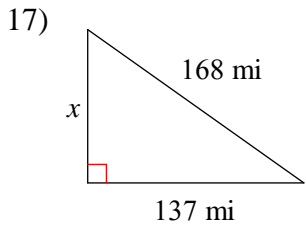
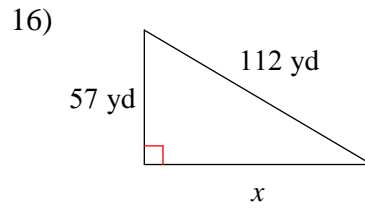
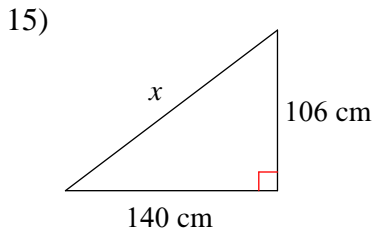
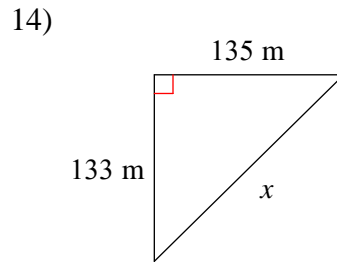
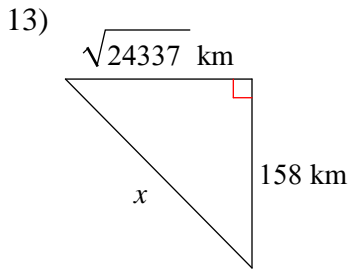
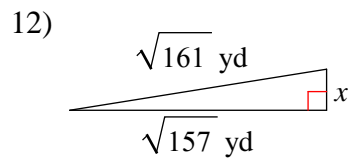
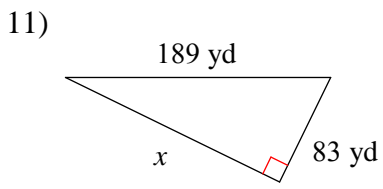

23)

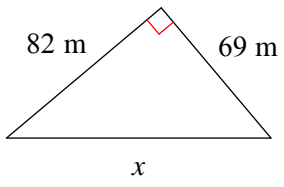

24)

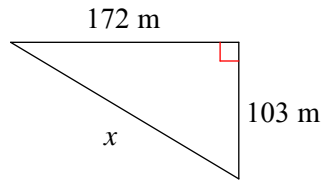

25)

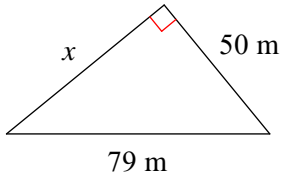

26)

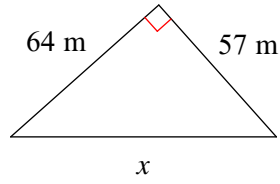

27)

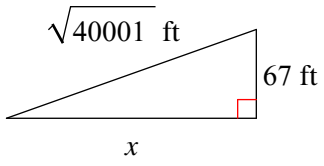

28)

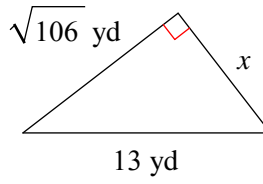

29)

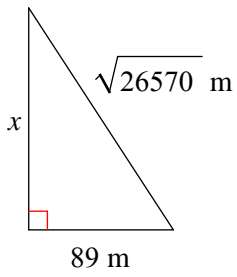

30)

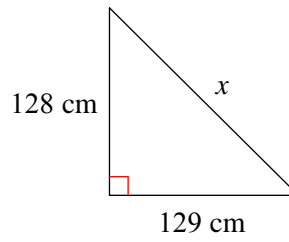

31)

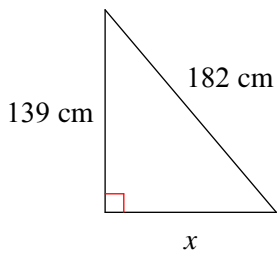

32)

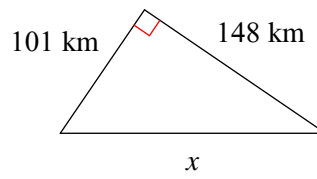

33)

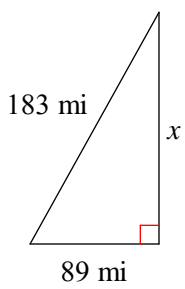

34)

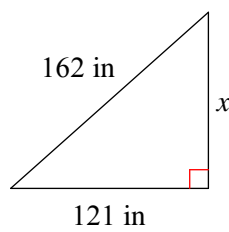

35)

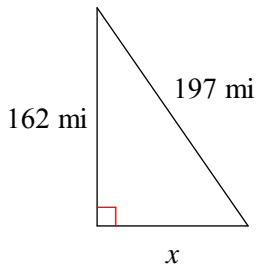

36)

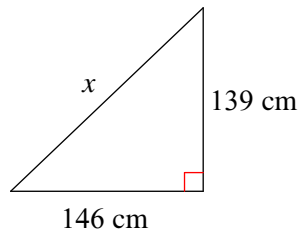

37)

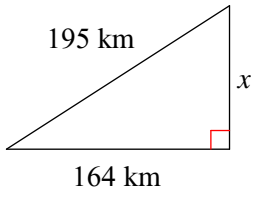

38)

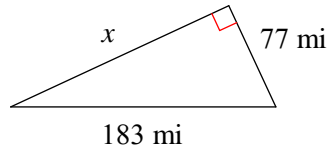

39)

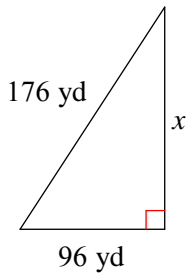

40)

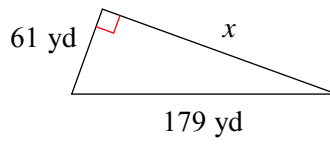

41)

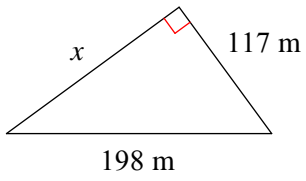

42)

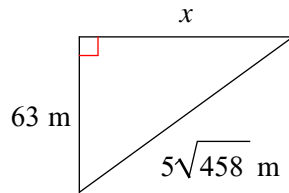

43)

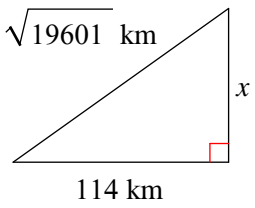

44)

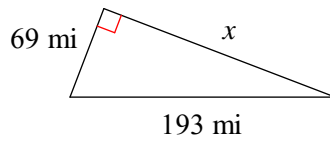

45)

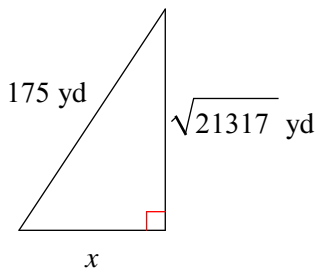

46)

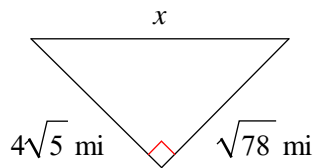

47)

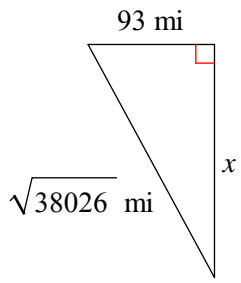

48)

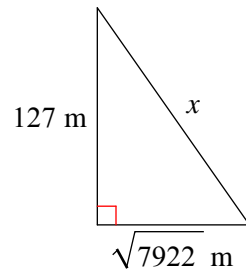

49)

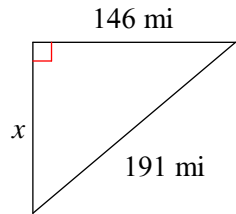

50)

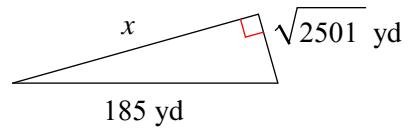

51)

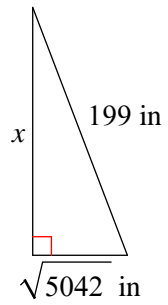

52)

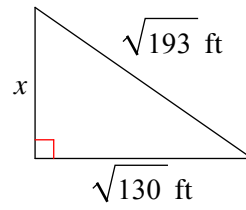

53)

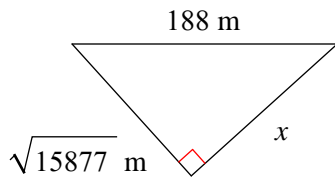

54)

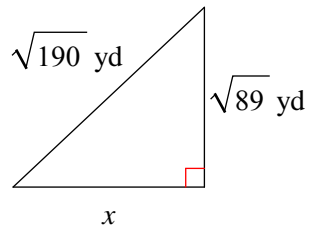

55)

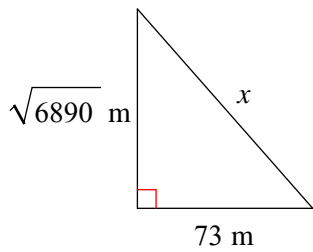

56)

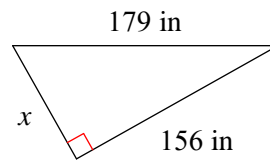

57)

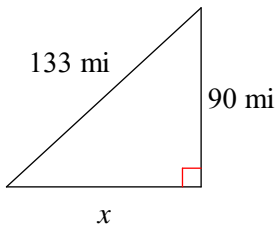

58)

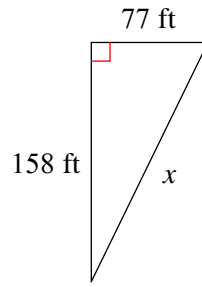

59)

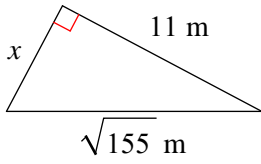

60)

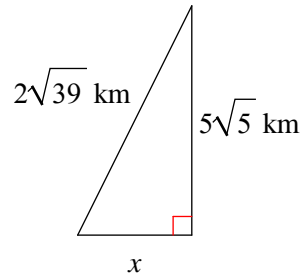

61)

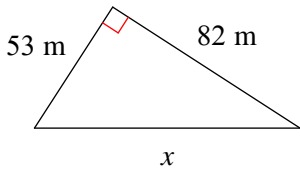

62)

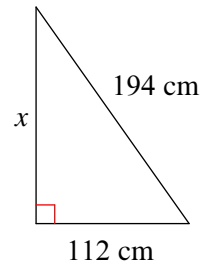

63)

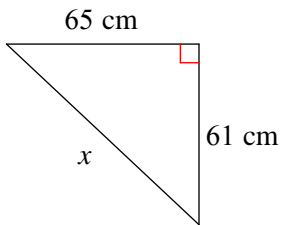

64)

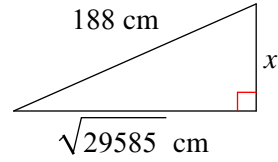

65)

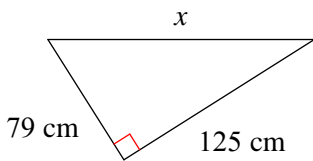

66)

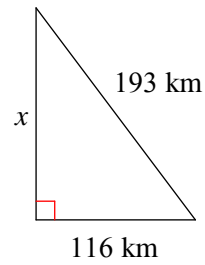

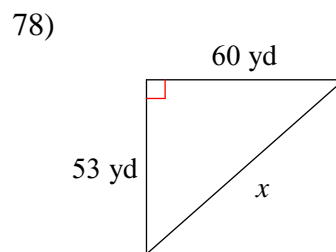
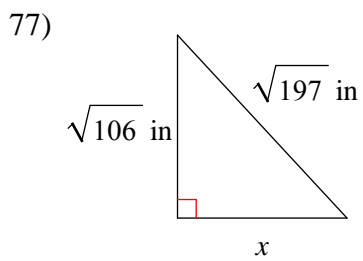
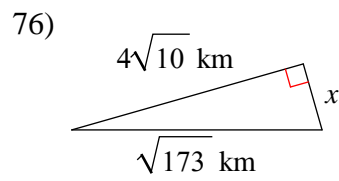
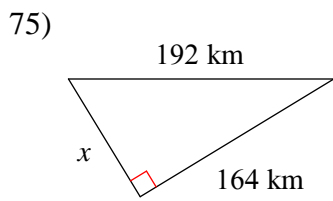
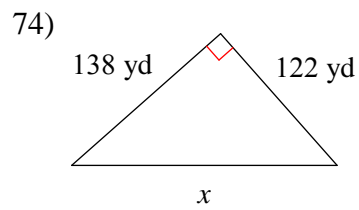
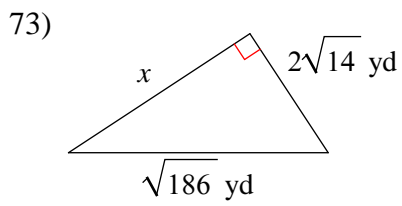
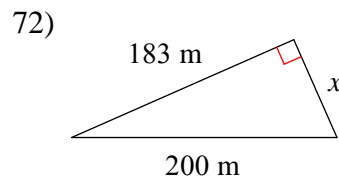
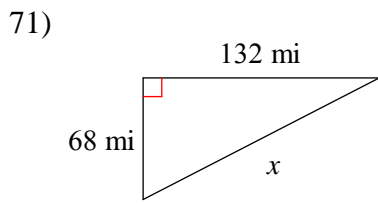
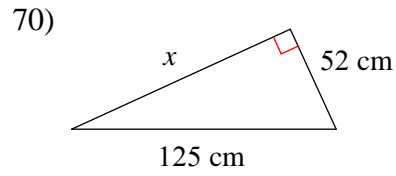
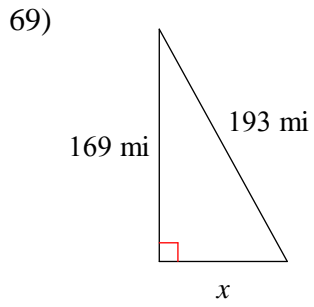
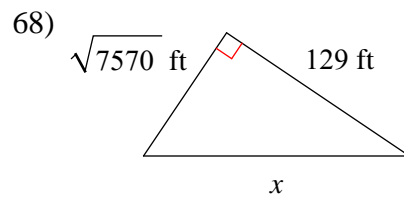
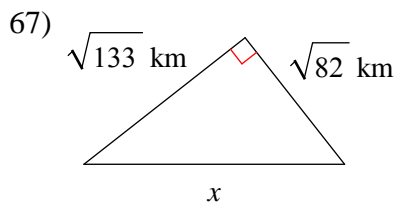

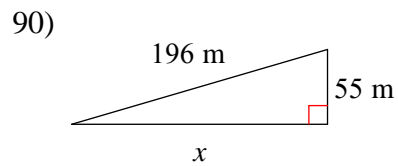
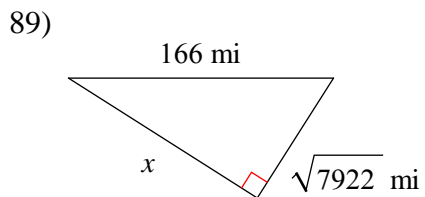
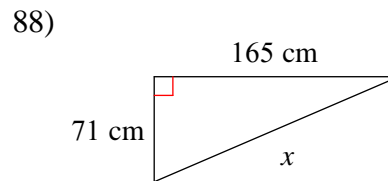
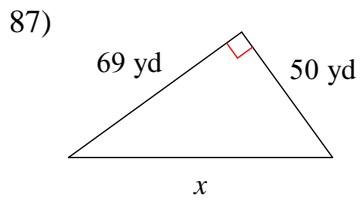
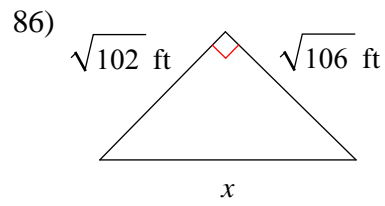
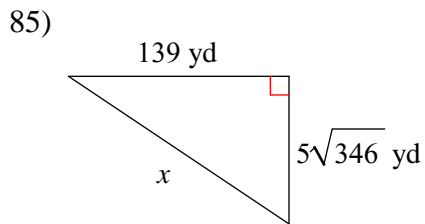
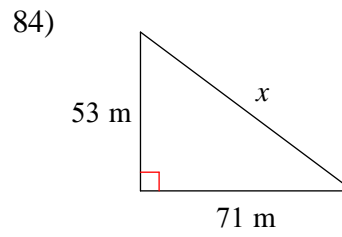
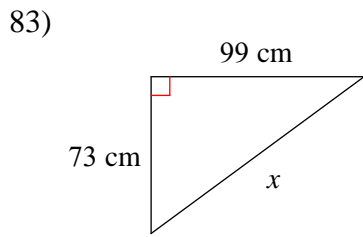
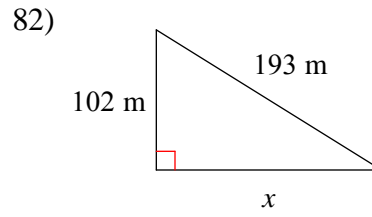
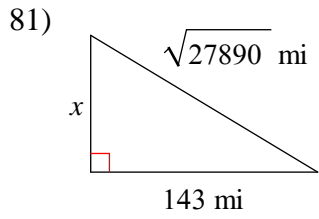
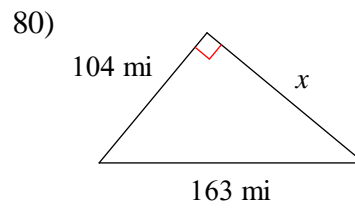
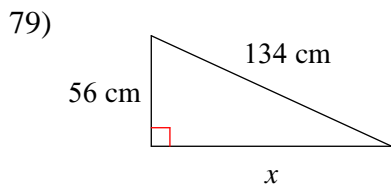



91)

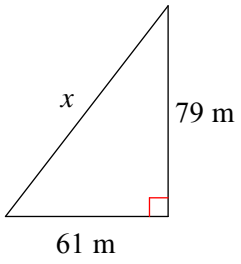

92)

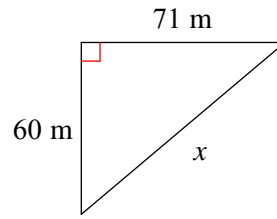

93)

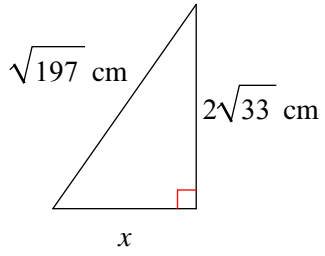

94)

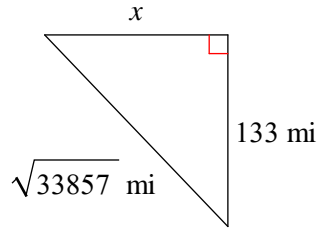

95)

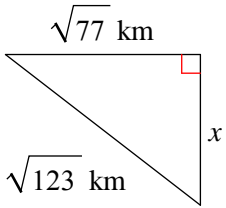

96)

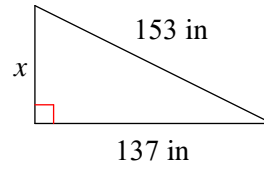

97)

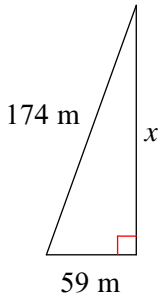

98)

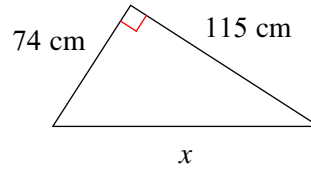

99)

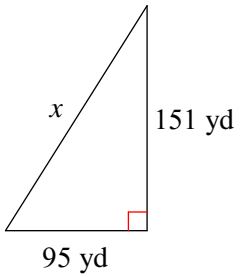

100)

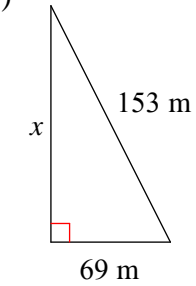

State if it is right triangle:

101)

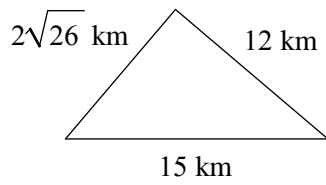

102)

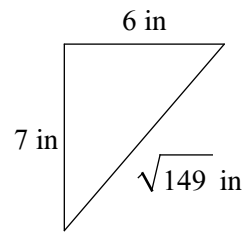

103)

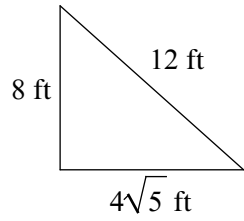

104)

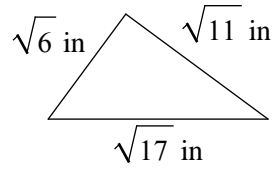

105)

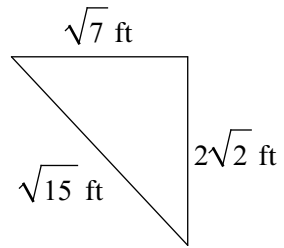

106)

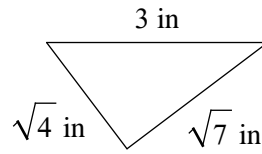

107)

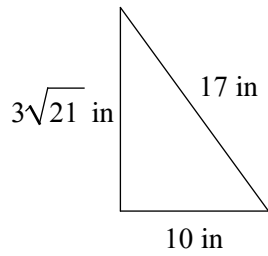

108)

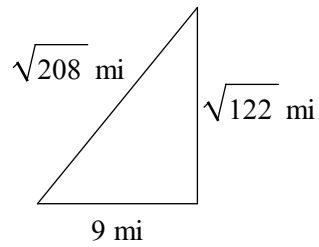

109)

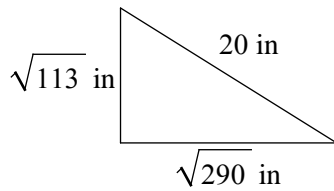

110)

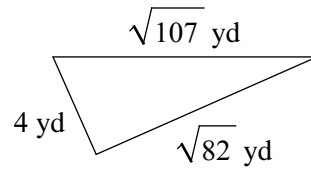

111)

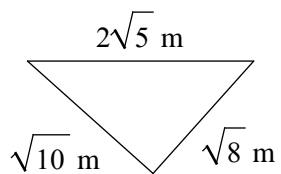

112)

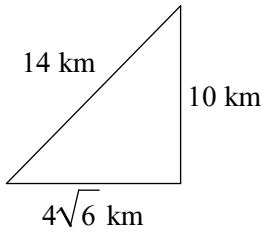

113)

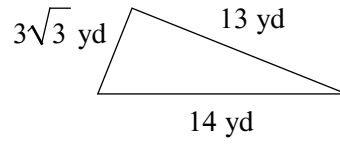

114)

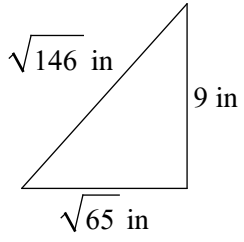

115)

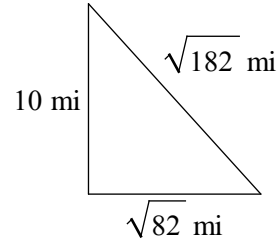

116)

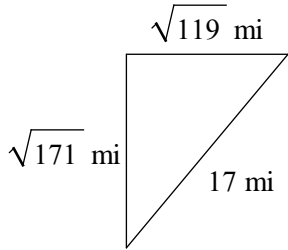

117)

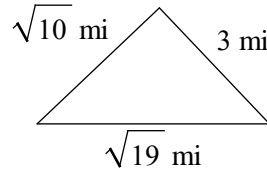

118)

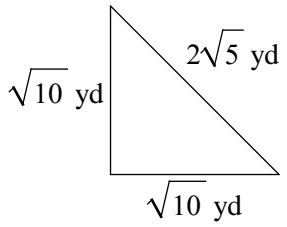

119)

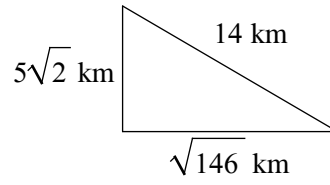

120)

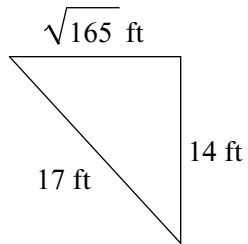

121)

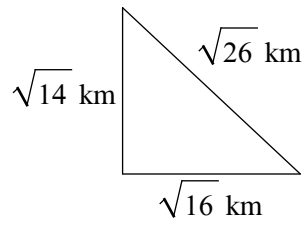

122)

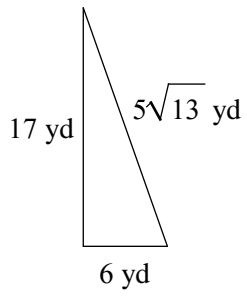

123)

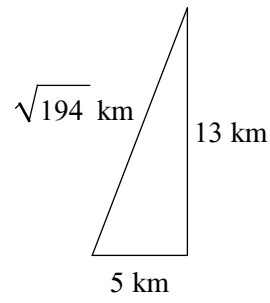

124)

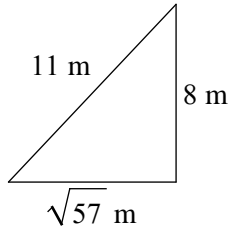

125)

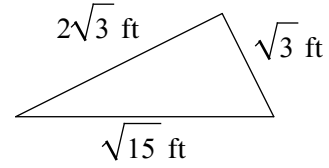

126)

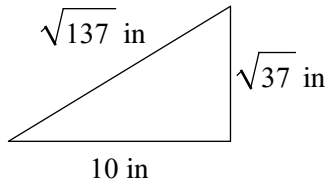

127)

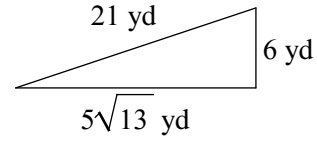

128)

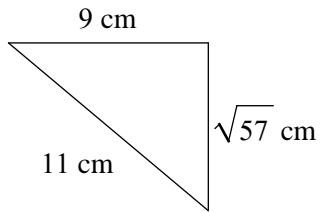

129)

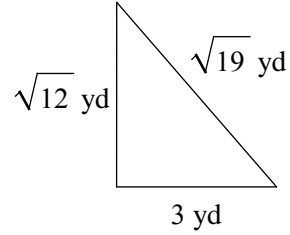

130)

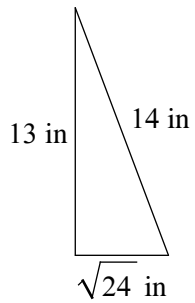

131)

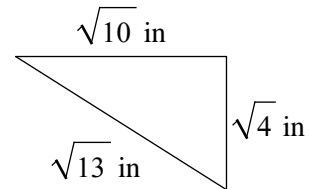

132)

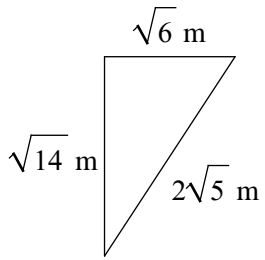

133)

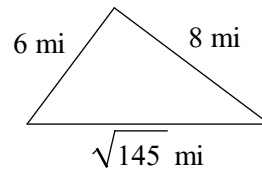

134)

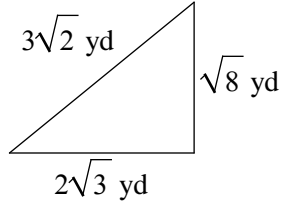

135)

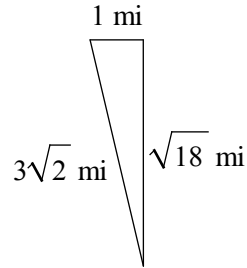

136)

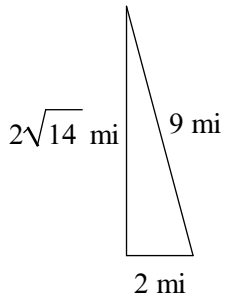

137)

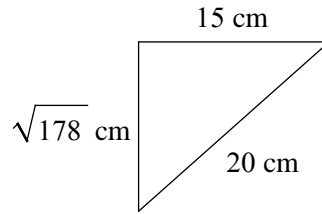

138)

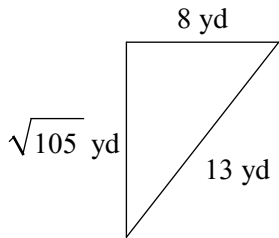

139)

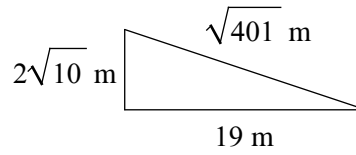

140)

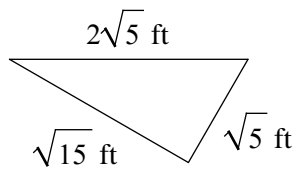

141)

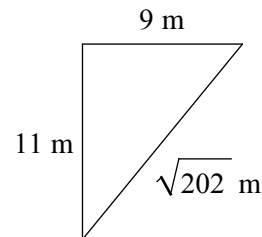

142)

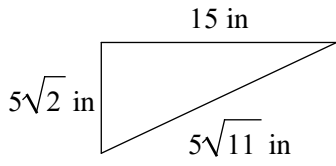

143)

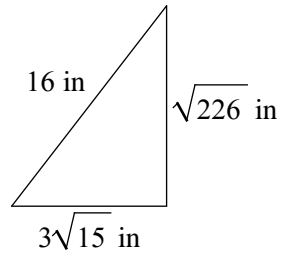

144)

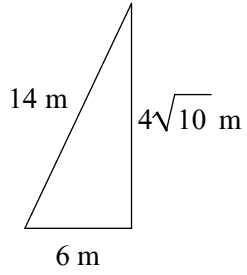

145)

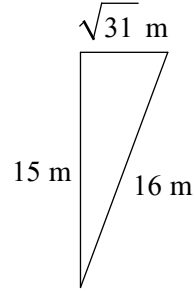

146)

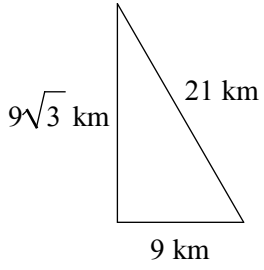

147)

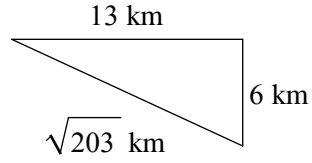

148)

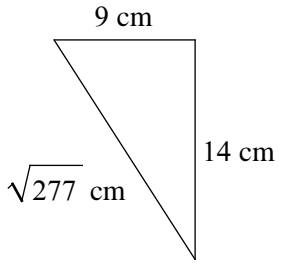

149)

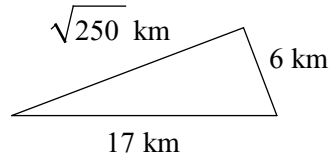

150)

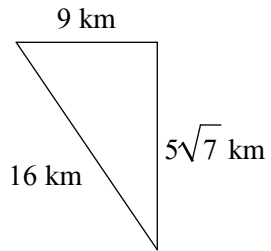

151)

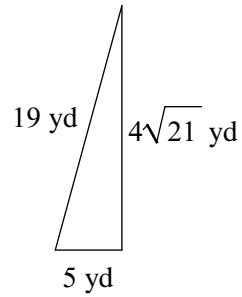

152)

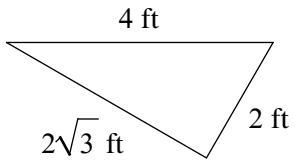

153)

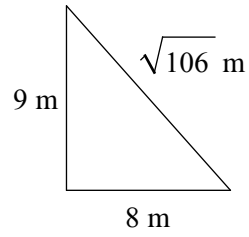

154)

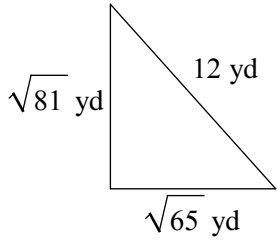

155)

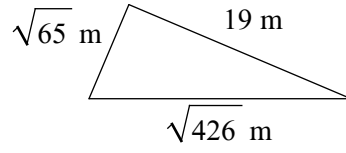

156)

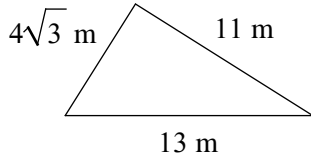

157)

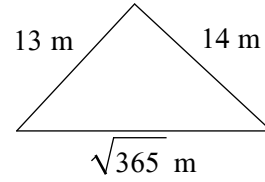

158)

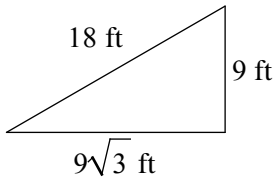

159)

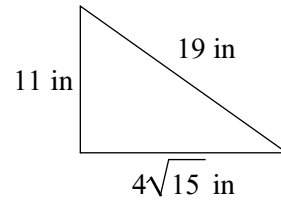

160)

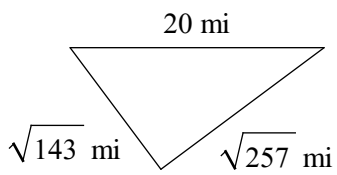

161)

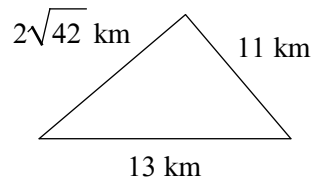

162)

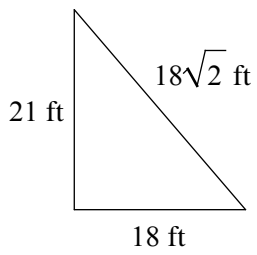

163)

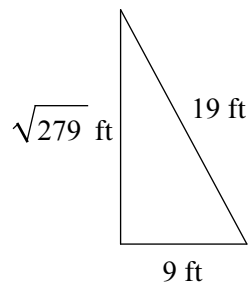

164)

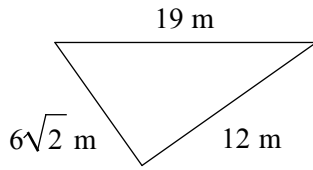

165)

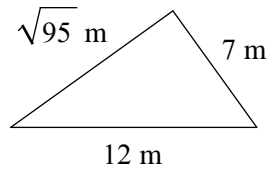

166)

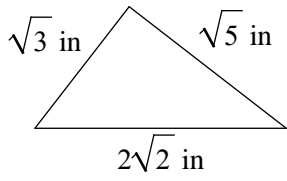

167)

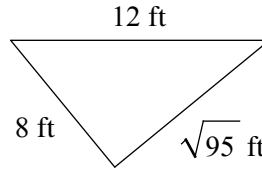

168)

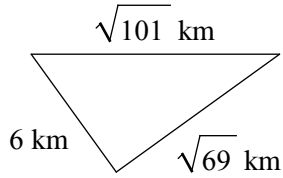

169)

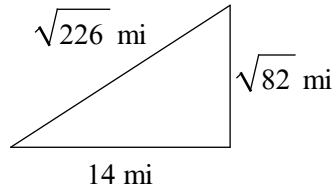

170)

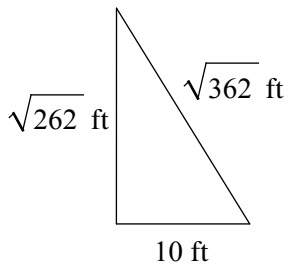

171)

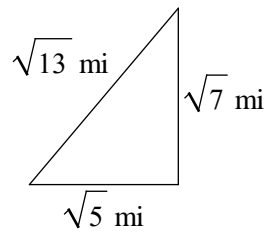

172)

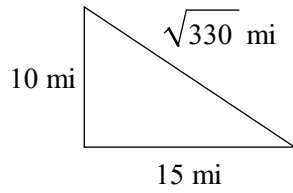

173)

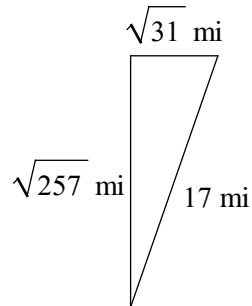

174)

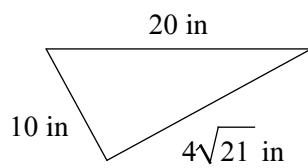

175)

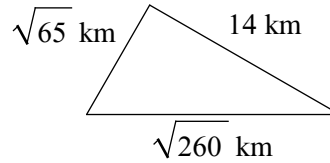



176)

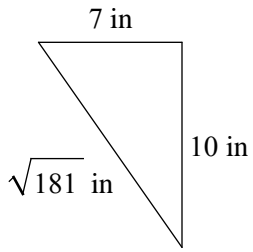

177)

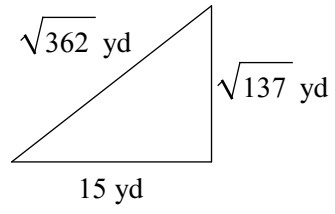

178)

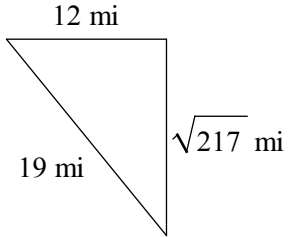

179)

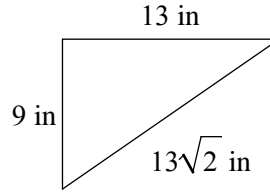

180)

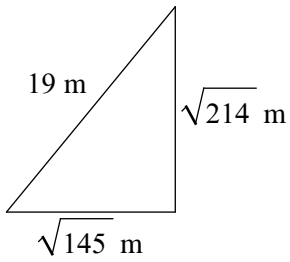

181)

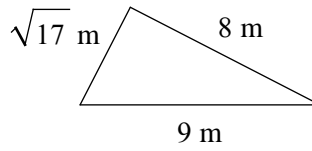

182)

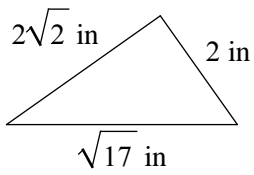

183)

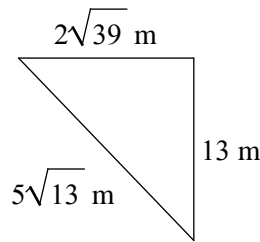

184)

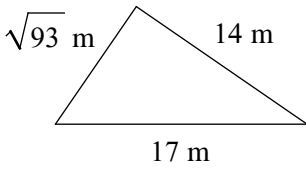

185)

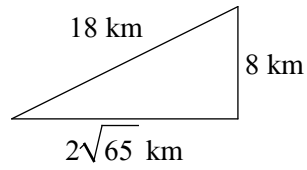

186)

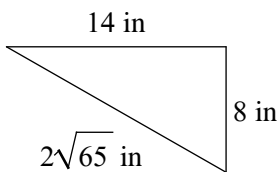

187)

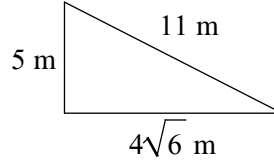

188)

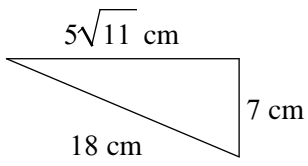

189)

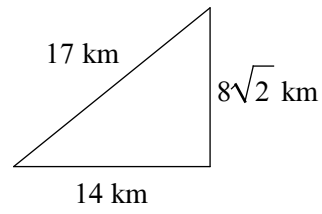

190)

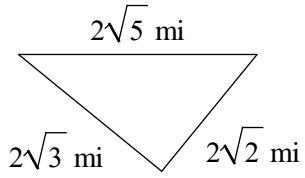

191)

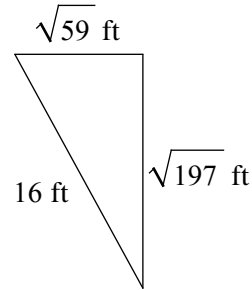

192)

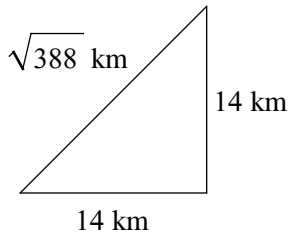

193)

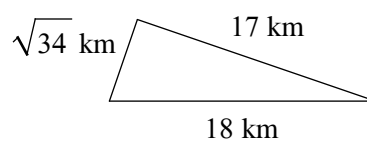

194)

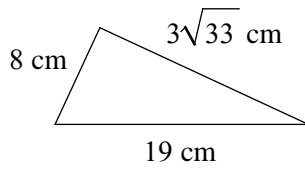

195)

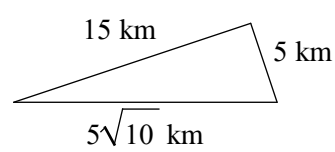

196)

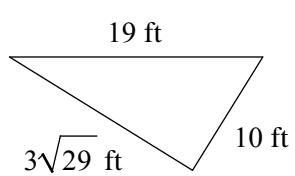

197)

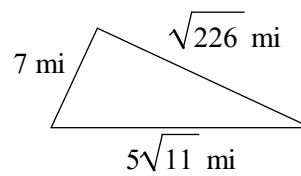

198)

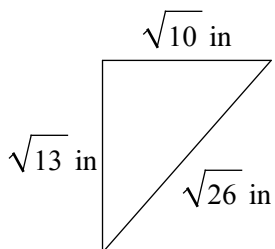

199)

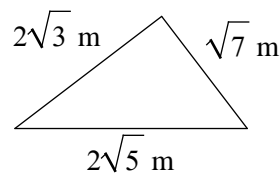

200)

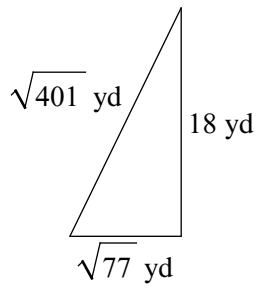

201)

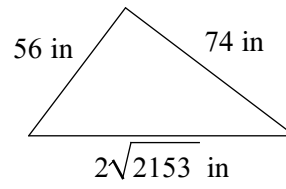

202)

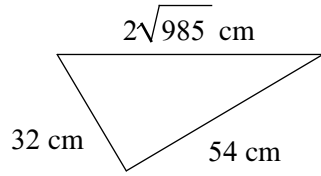

203)

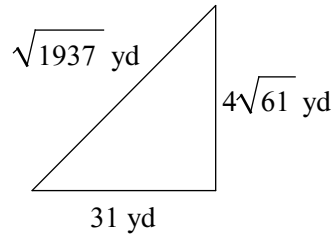

204)

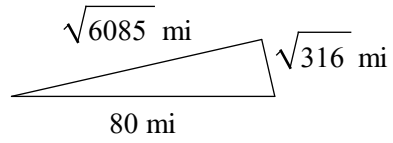

205)

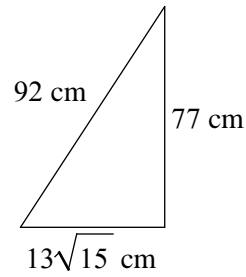

206)

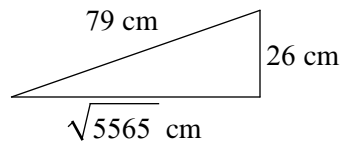

207)

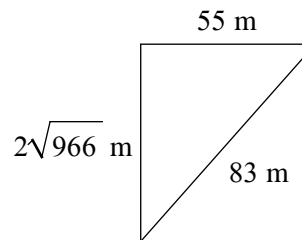

208)

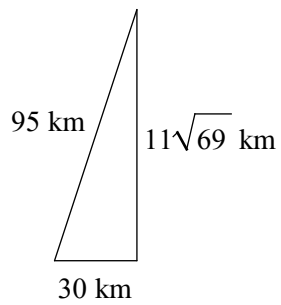

209)

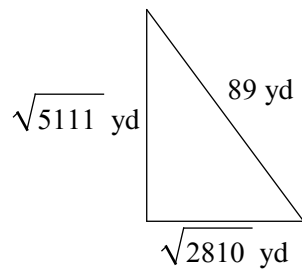

210)

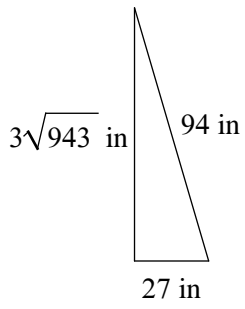

211)

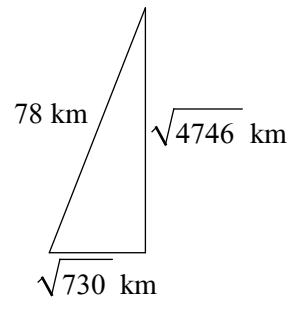

212)

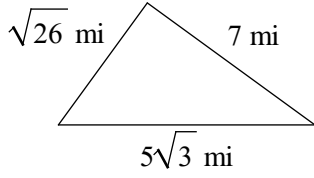

213)

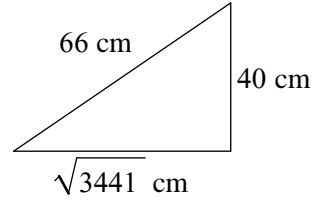

214)

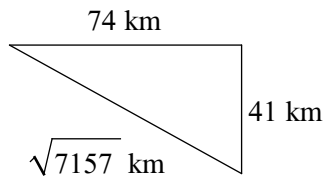

215)

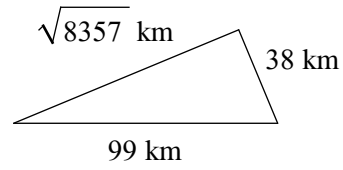

216)

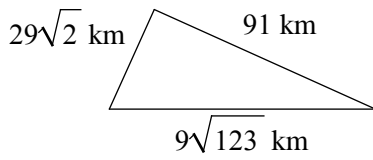

217)

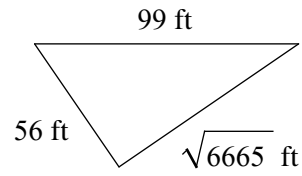

218)

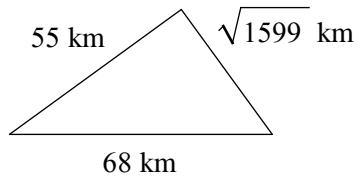

219)

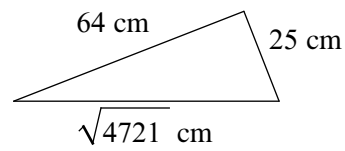

220)

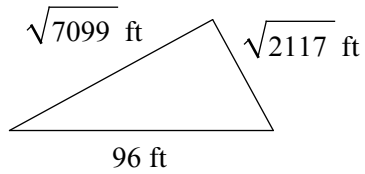

221)

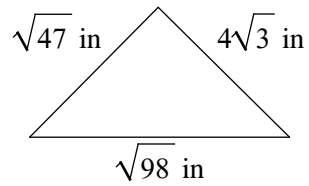

222)

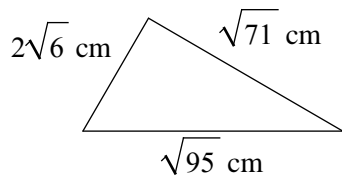

223)

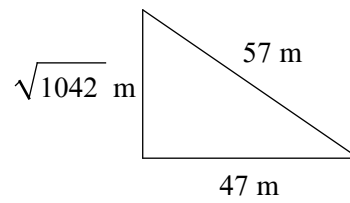

224)

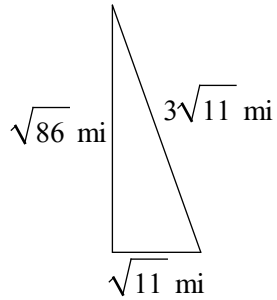

225)

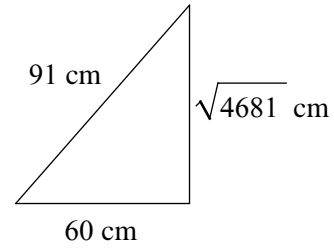

226)

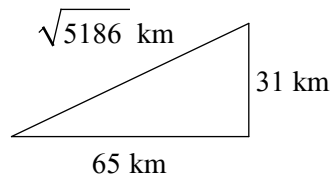

227)

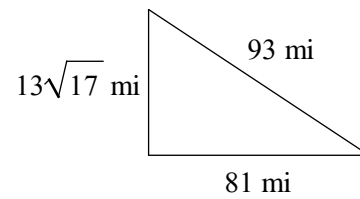

228)

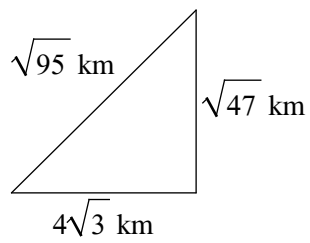

229)

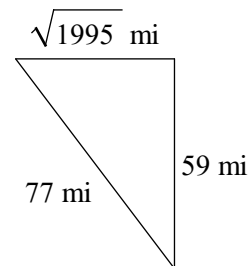

230)

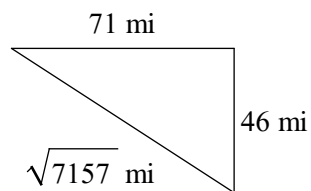

231)

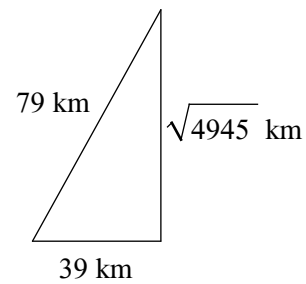

232)

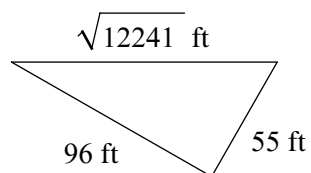

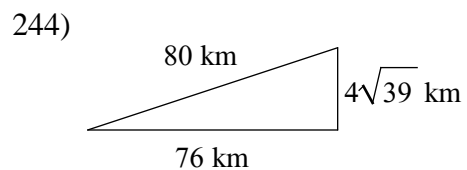
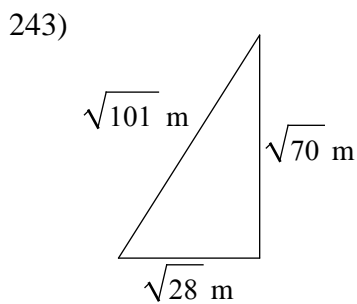
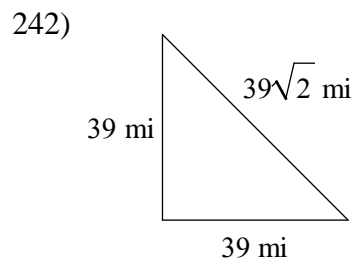
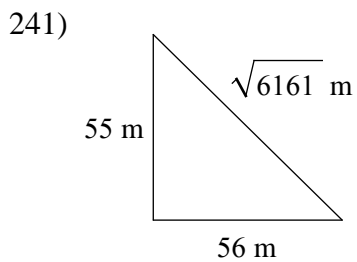
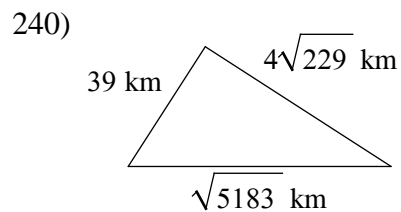
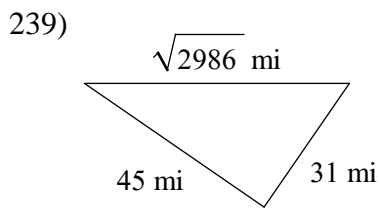
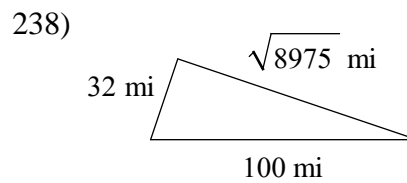
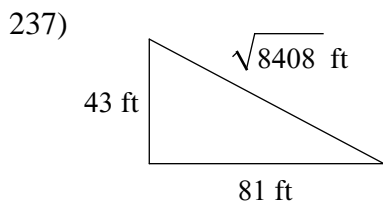
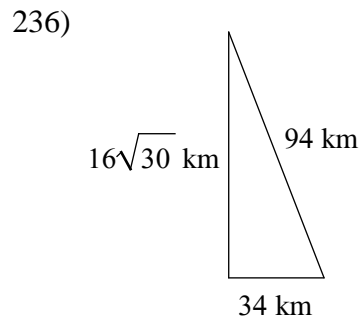
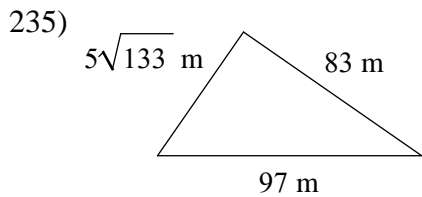
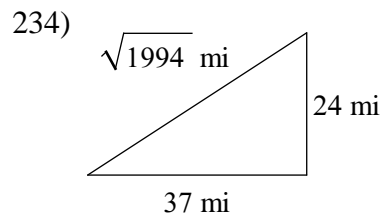
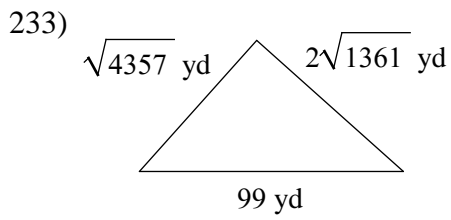

245)

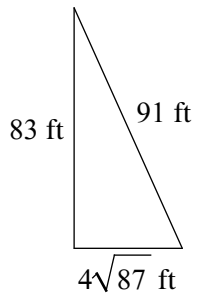

246)

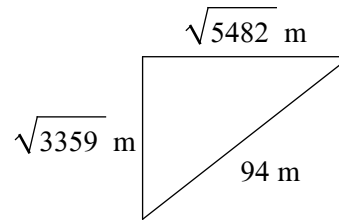

247)

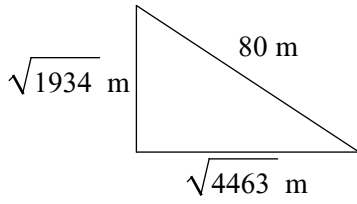

248)

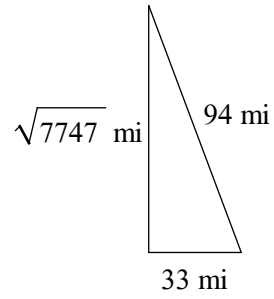

249)

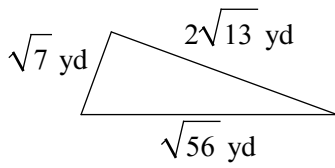

250)

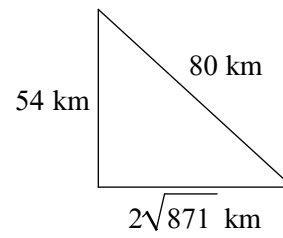

251)

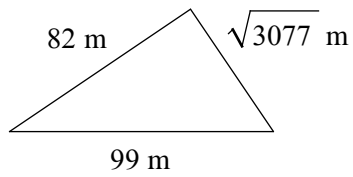

252)

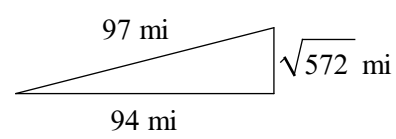

253)

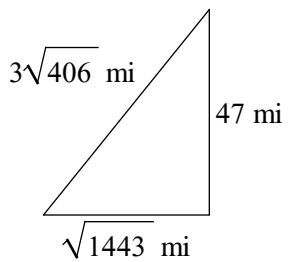

254)

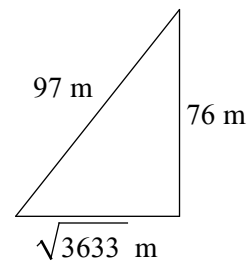

255)

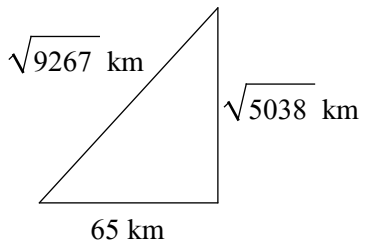

256)

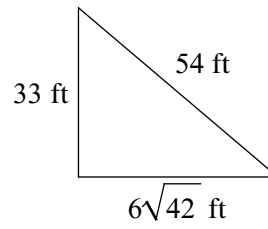

257)

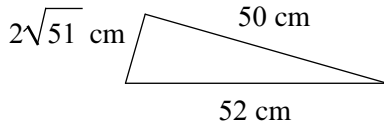

258)

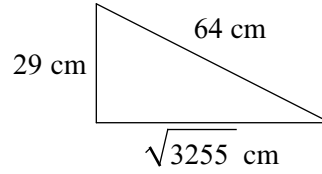

259)

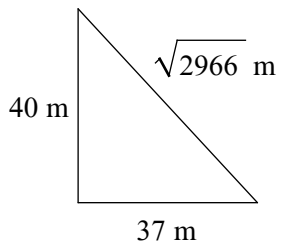

260)

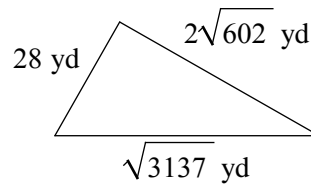

261)

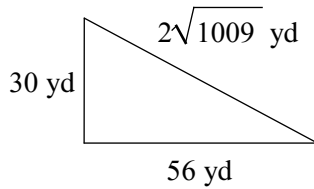

262)

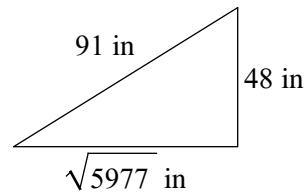

263)

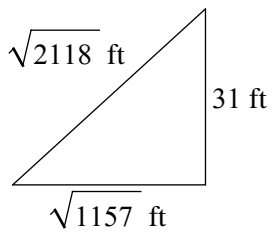

264)

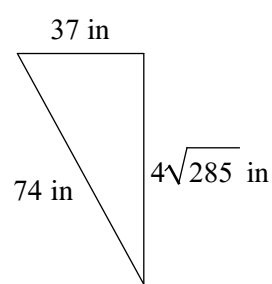

265)

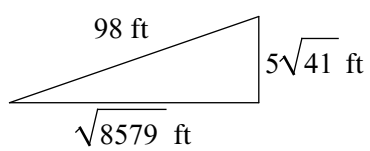

266)

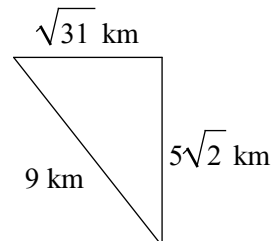



267)

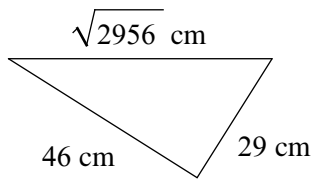

268)

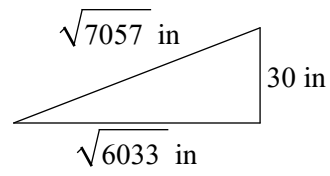

269)

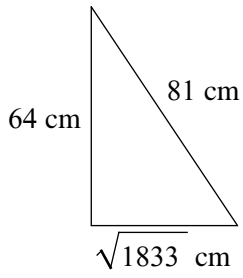

270)

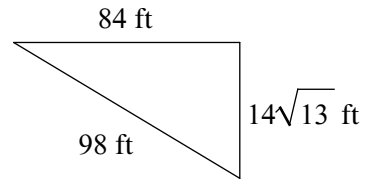

271)

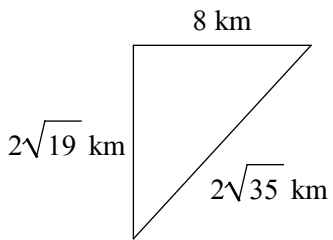

272)

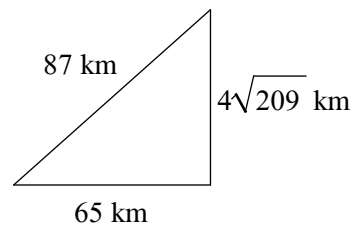

273)

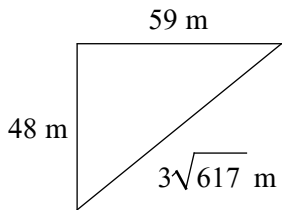

274)

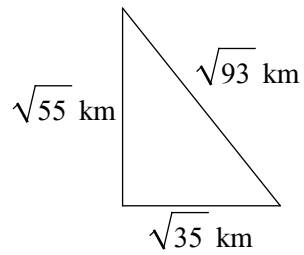

275)

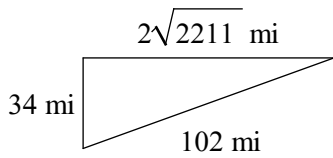

276)

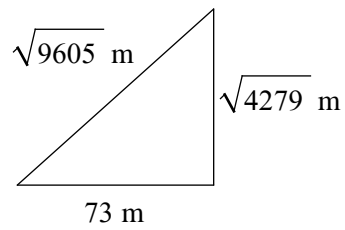

277)

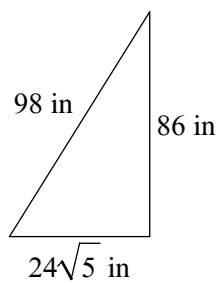

278)

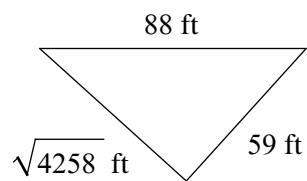

279)

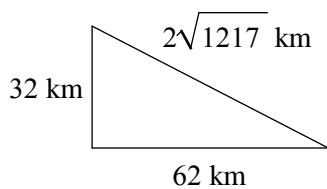

280)

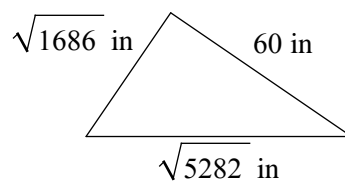

281)

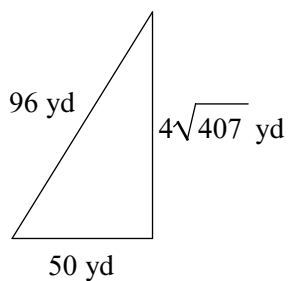

282)

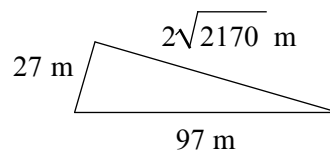

283)

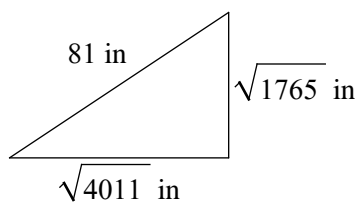

284)

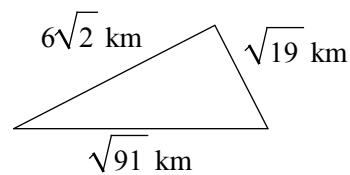

285)

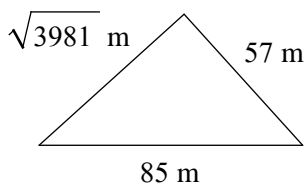

286)

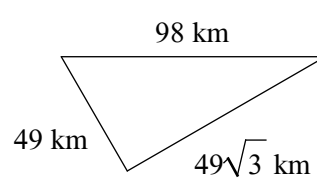

287)

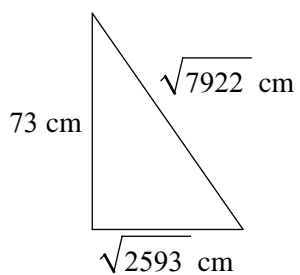

288)

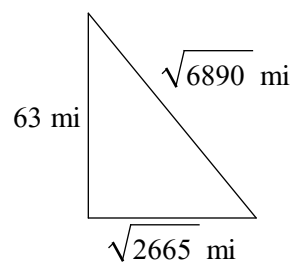

289)

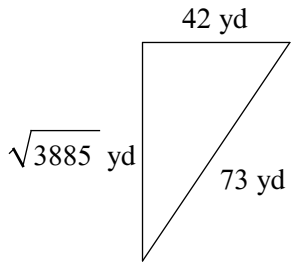

290)

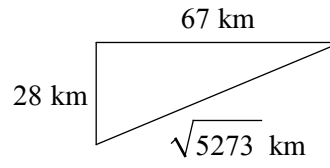

291)

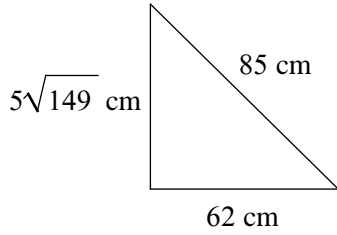

292)

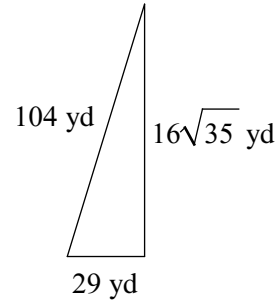

293)

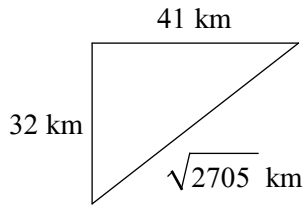

294)

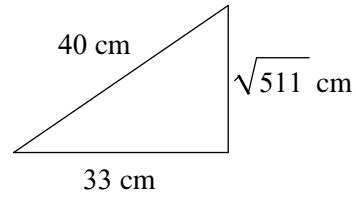

295)

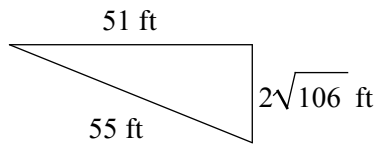

296)

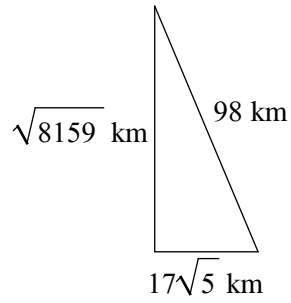

297)

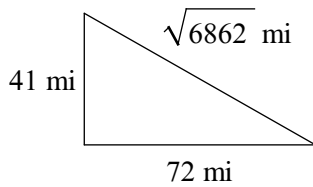

298)

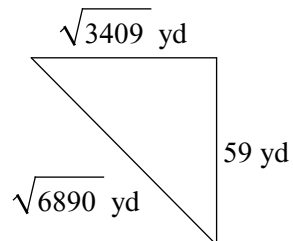

299)

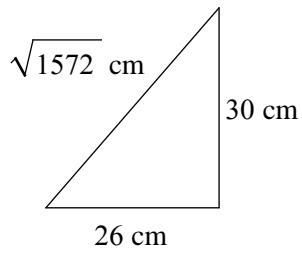

300)

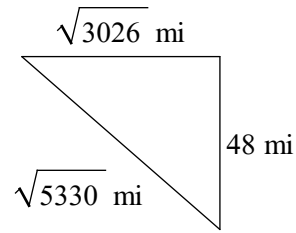

**What type of triangle is this? Acute, obtuse or right?**

301)

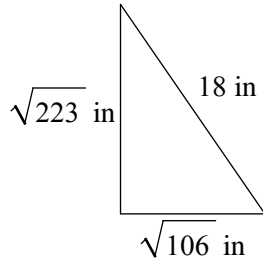

302)

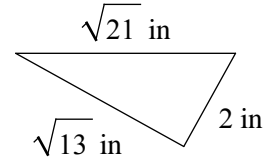

303)

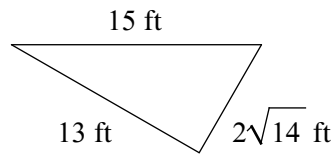

304)

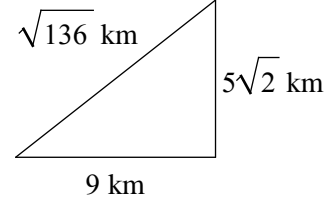

305)

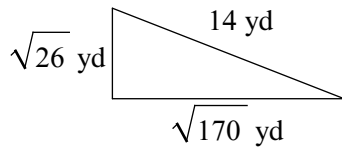

306)

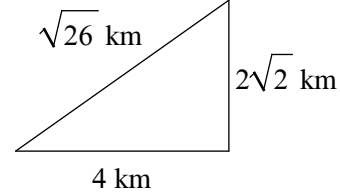

307)

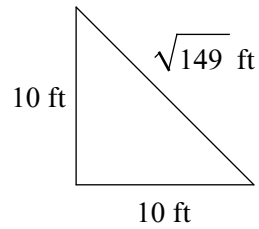

308)

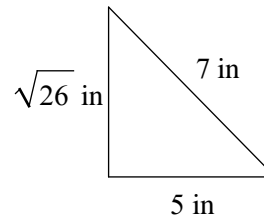

309)

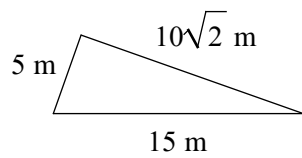

310)

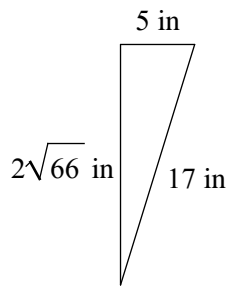

311)

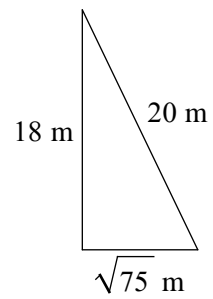

312)

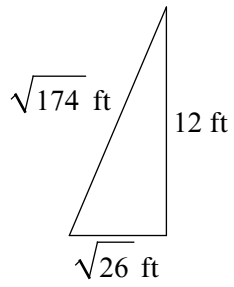

313)

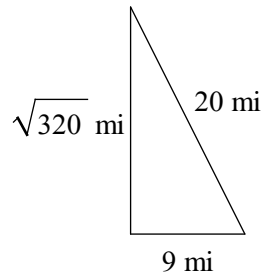

314)

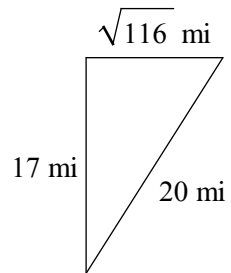

315)

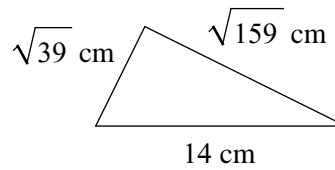

316)

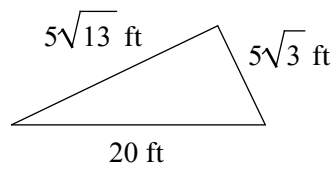

317)

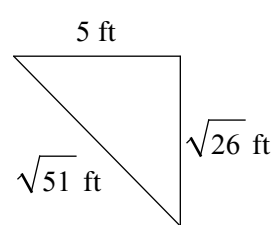

318)

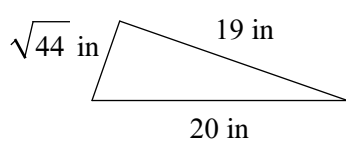

319)

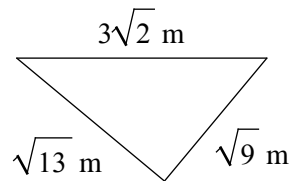

320)

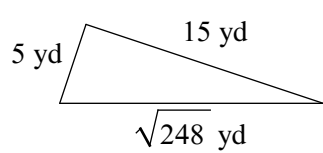

321)

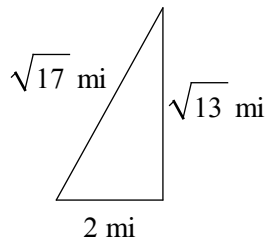

322)

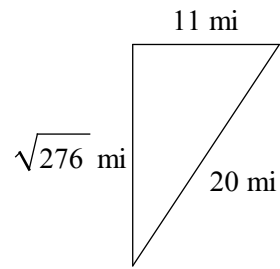

323)

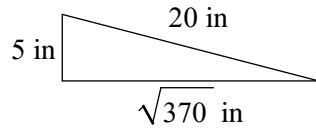

324)

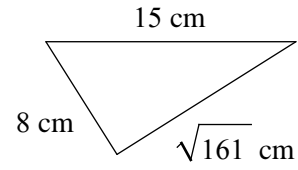

325)

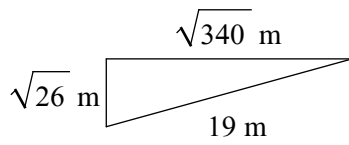

326)

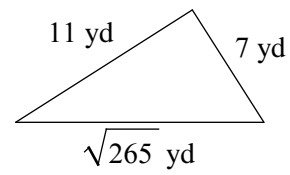

327)

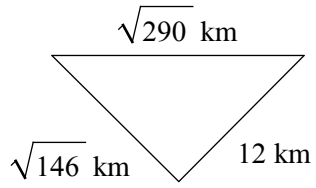

328)

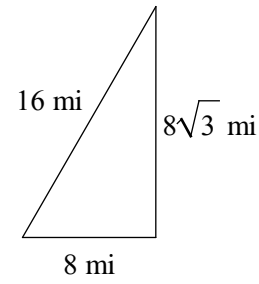

329)

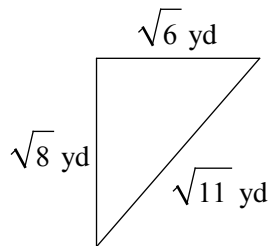

330)

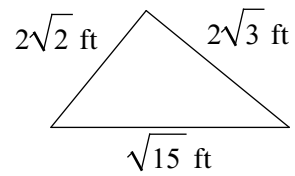

331)

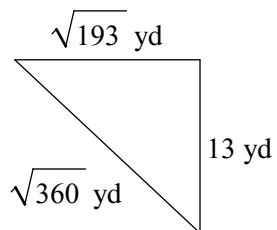

332)

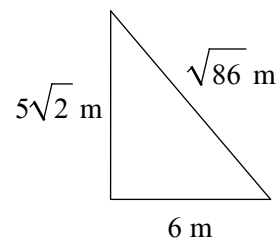

333)

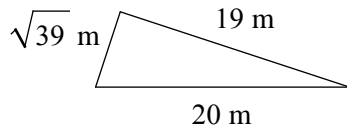

334)

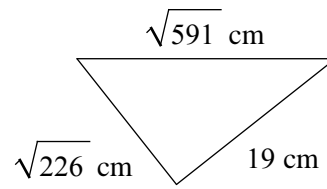

335)

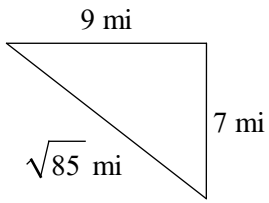

336)

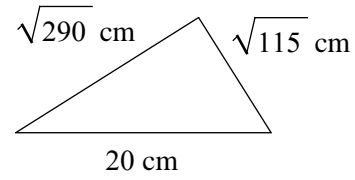

337)

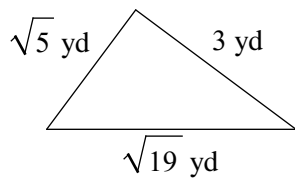

338)

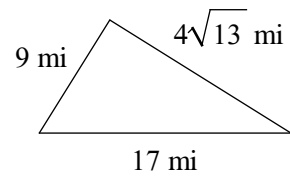

339)

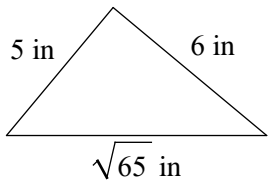

340)

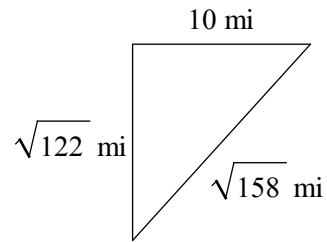

341)

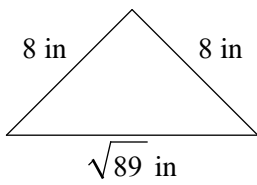

342)

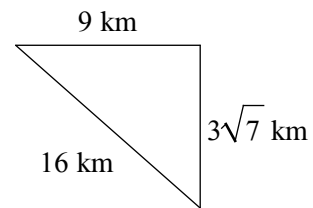

343)

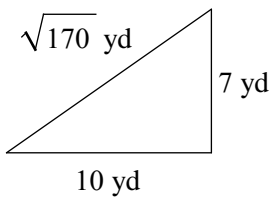

344)

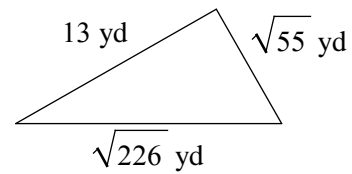

345)

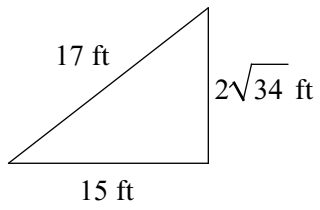

346)

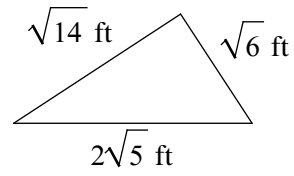

347)

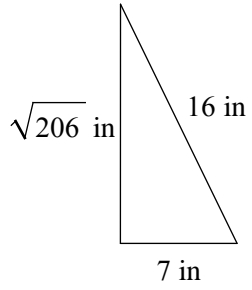

348)

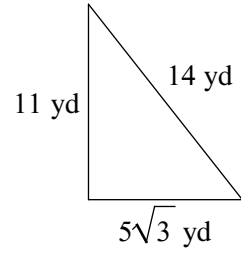

349)

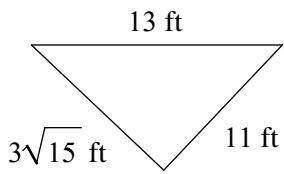

350)

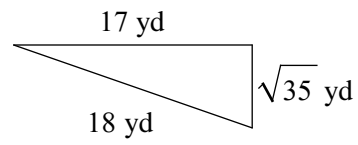

351)

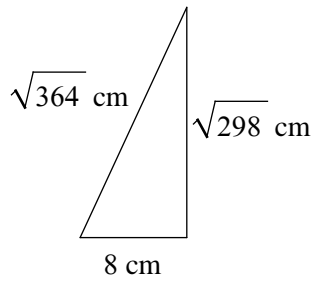

352)

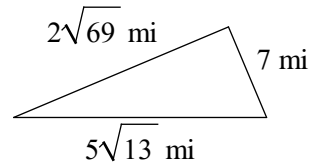

353)

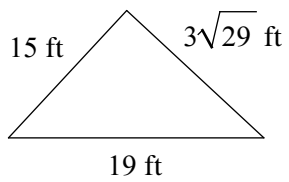

354)

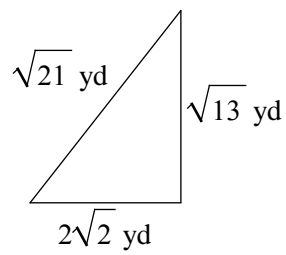

355)

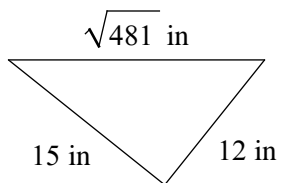



356)

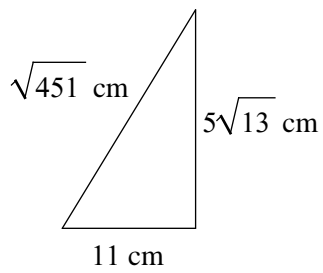

357)

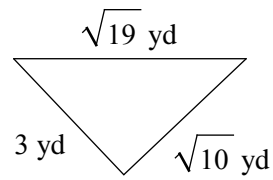

358)

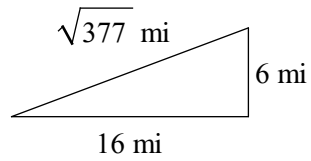

359)

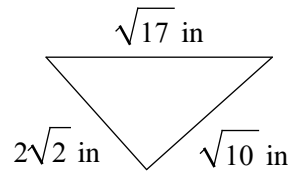

360)

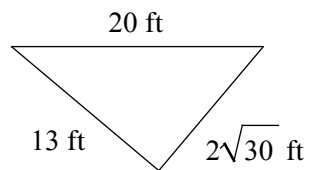

361)

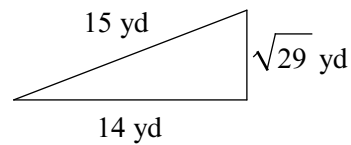

362)

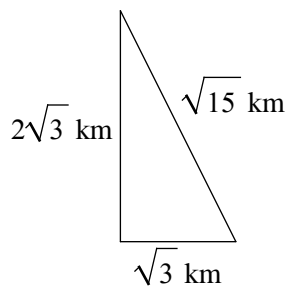

363)

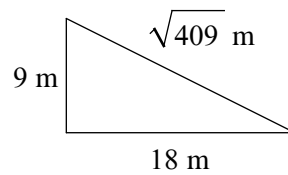

364)

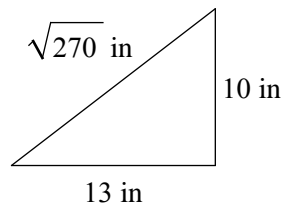

365)

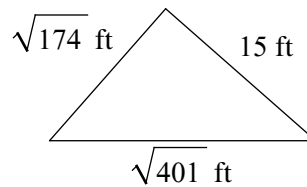

366)

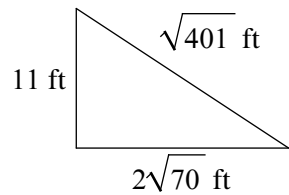

367)

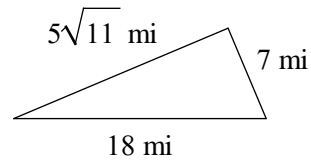

368)

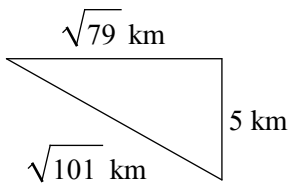

369)

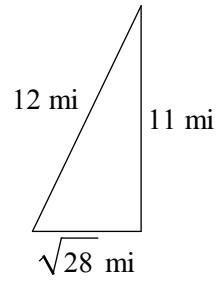

370)

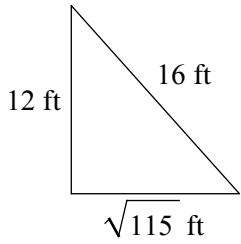

371)

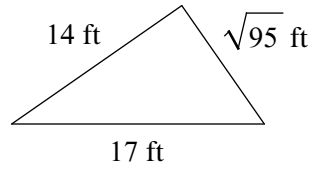

372)

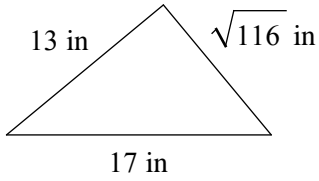

373)

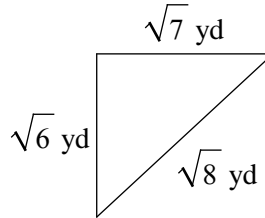

374)

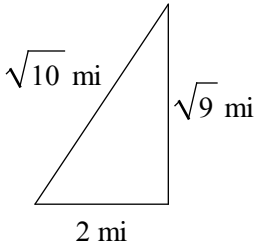

375)

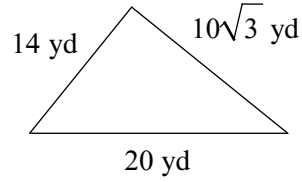

376)

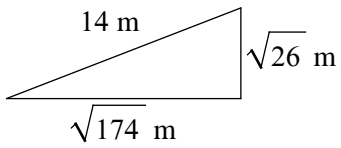

377)

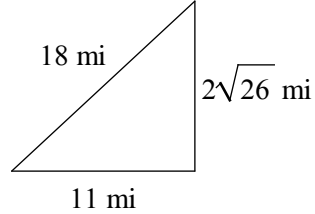

378)

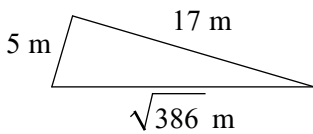

379)

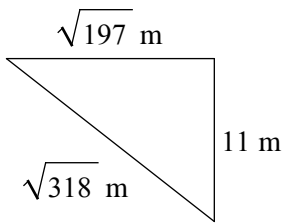

380)

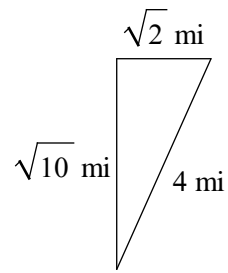

381)

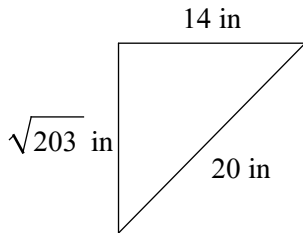

382)

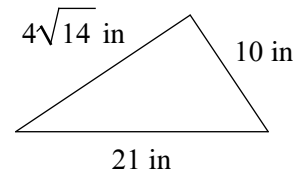

383)

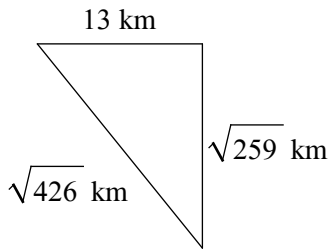

384)

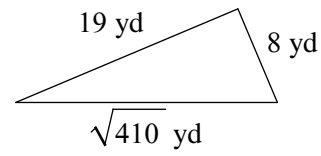

385)

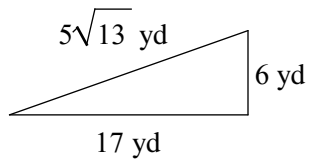

386)

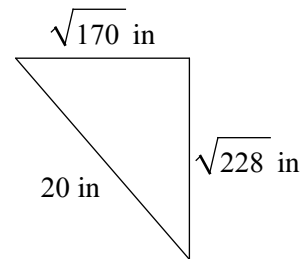

387)

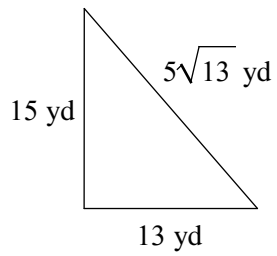

388)

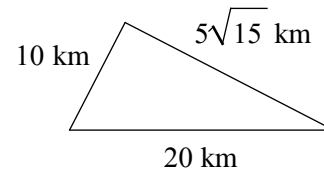

389)

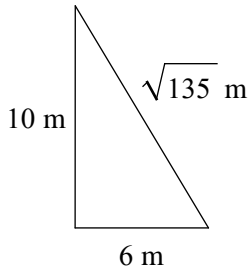

390)

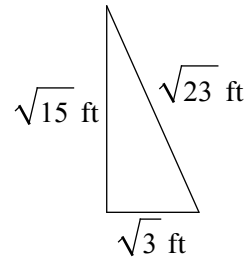

391)

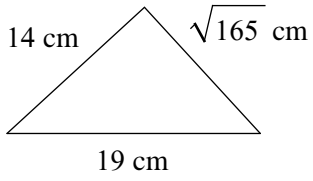

392)

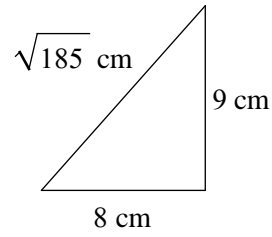

393)

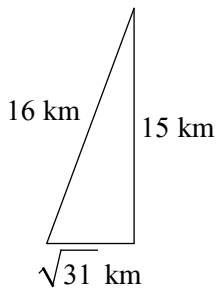

394)

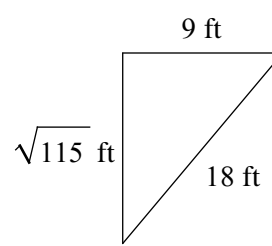

395)

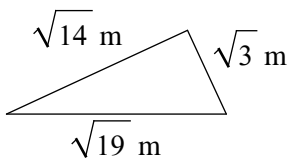

396)

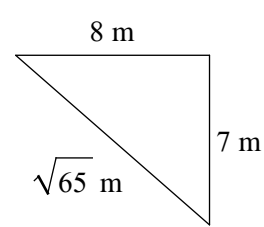

397)

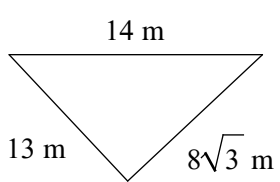

398)

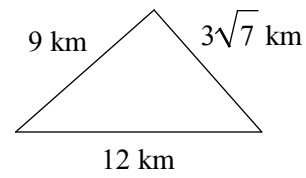

399)

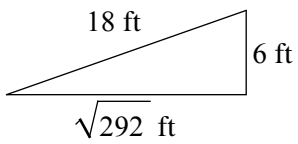

400)

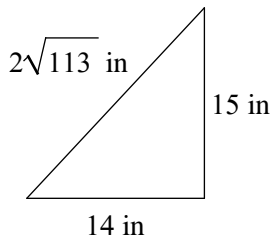

401)

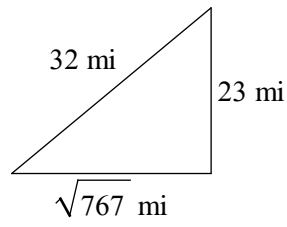

402)

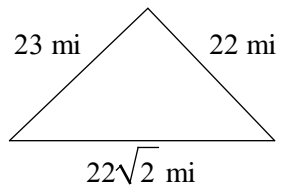

403)

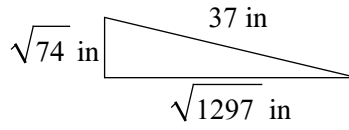

404)

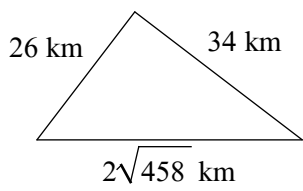

405)

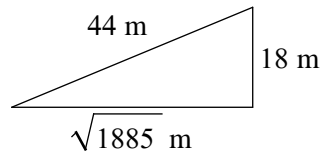

406)

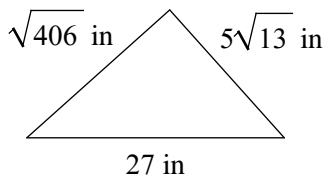

407)

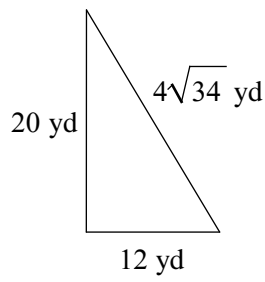

408)

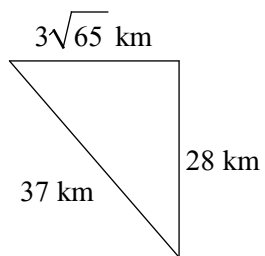

409)

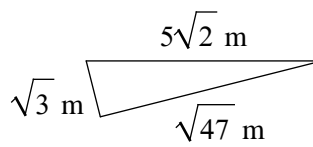

410)

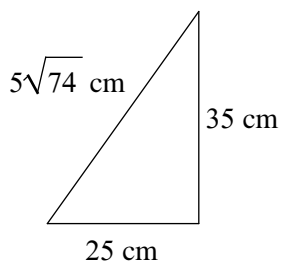

411)

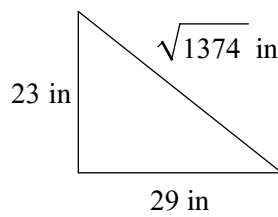

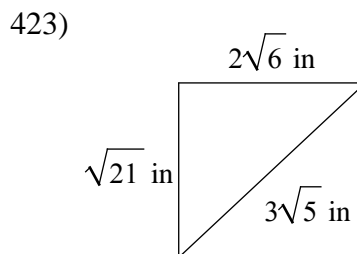
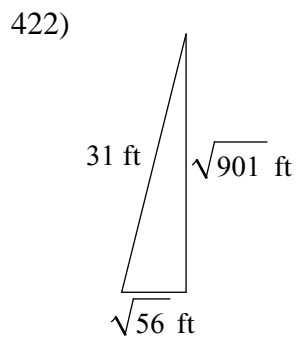
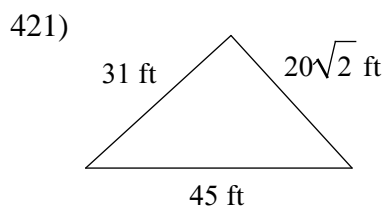
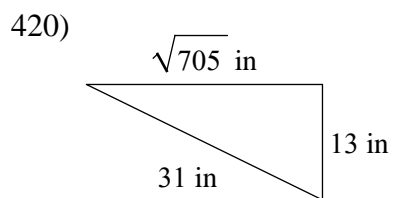
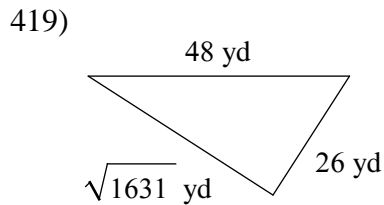
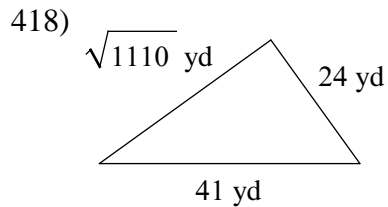
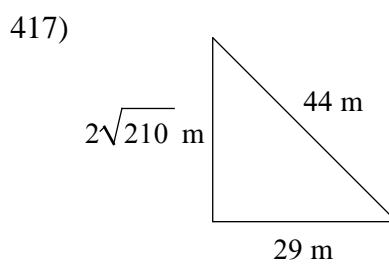
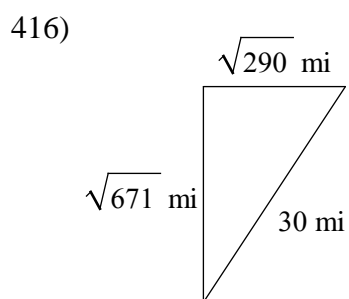
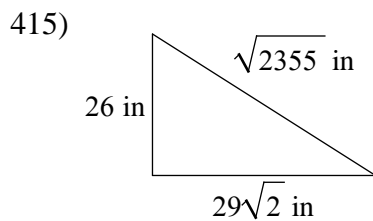
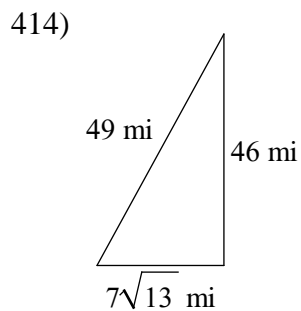
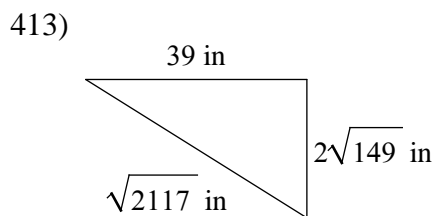
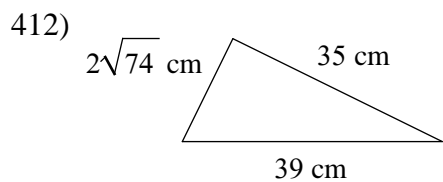

424)

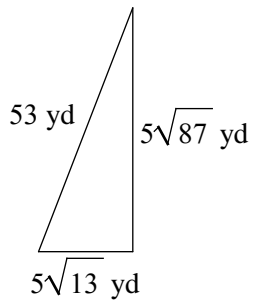

425)

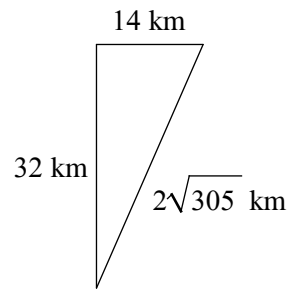

426)

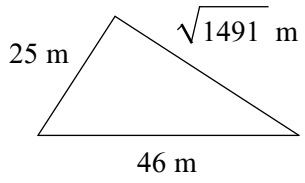

427)

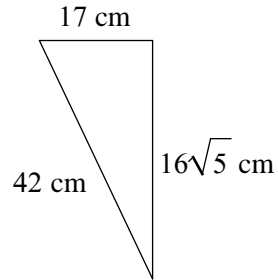

428)

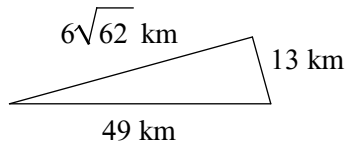

429)

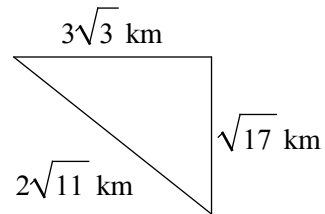

430)

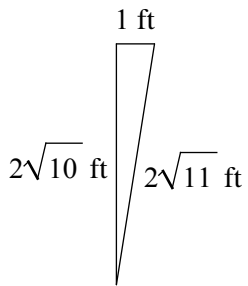

431)

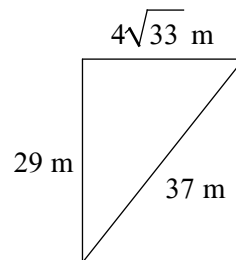

432)

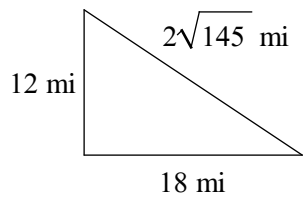

433)

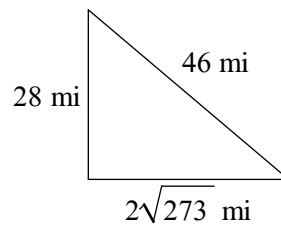

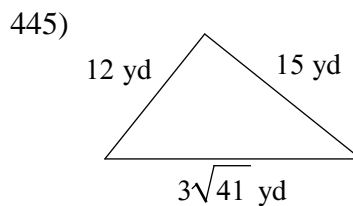
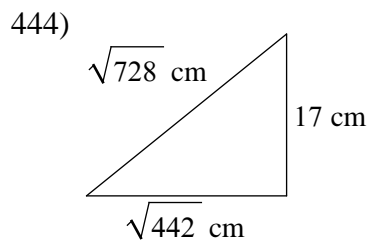
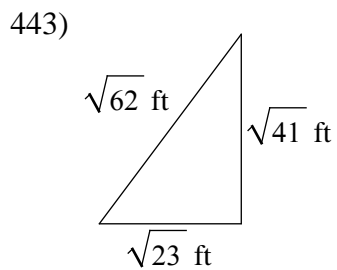
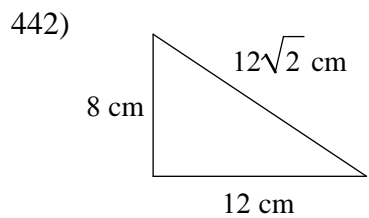
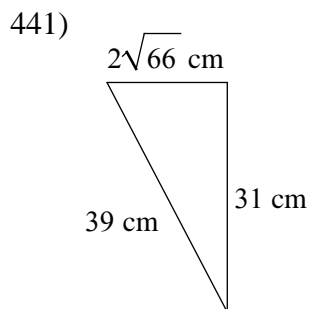
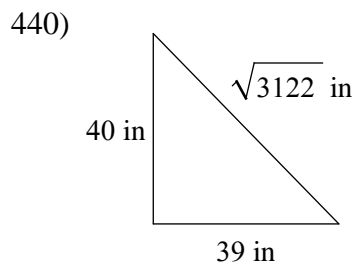
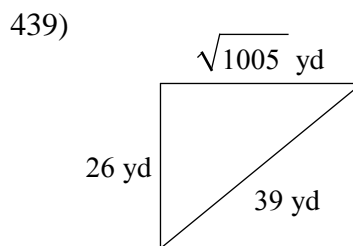
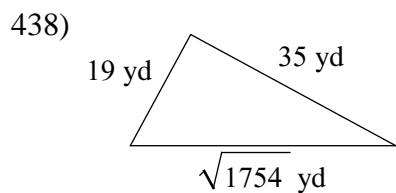
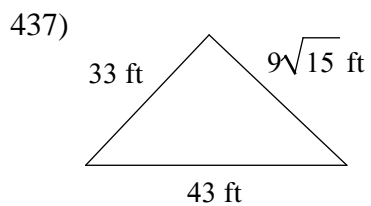
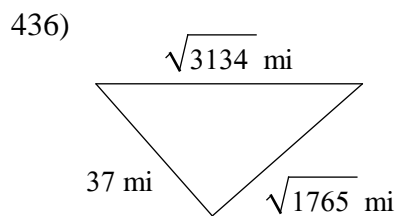
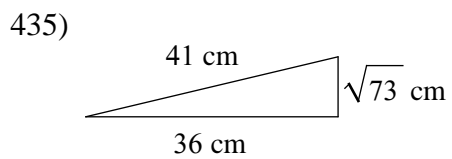
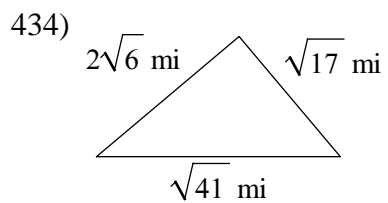



446)

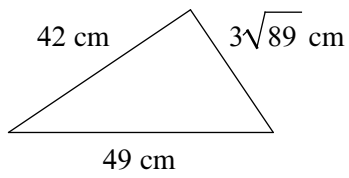

447)

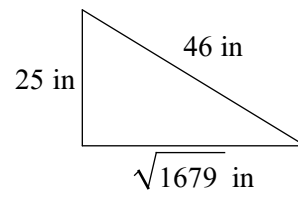

448)

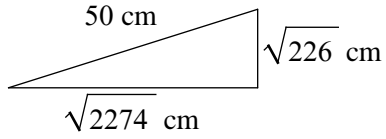

449)

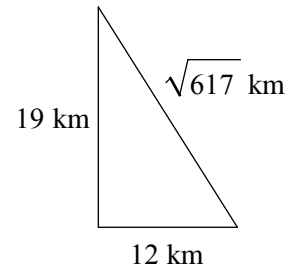

450)

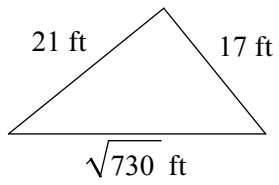

451)

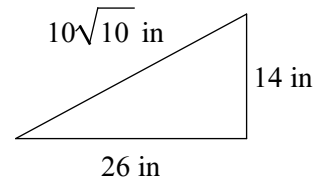

452)

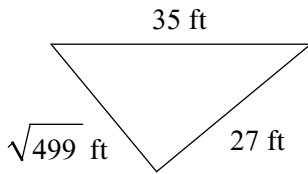

453)

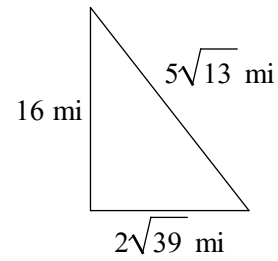

454)

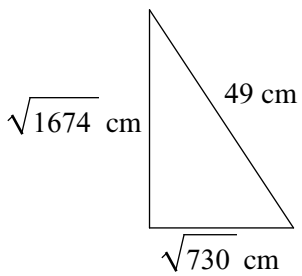

455)

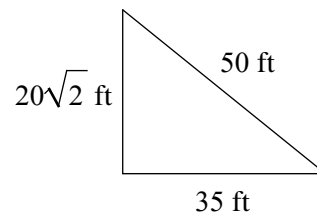

456)

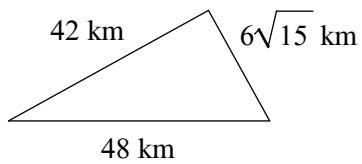

457)

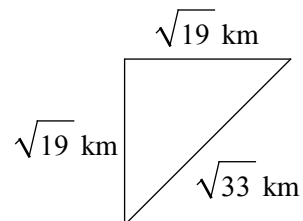

458)

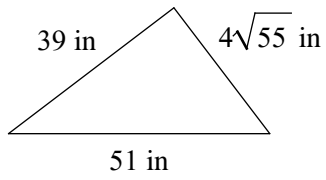

459)

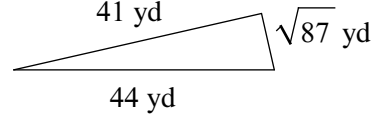

460)

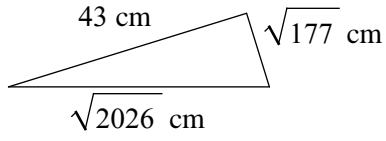

461)

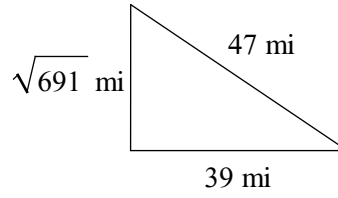

462)

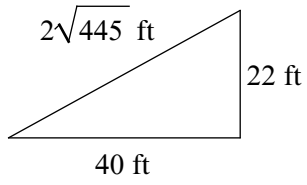

463)

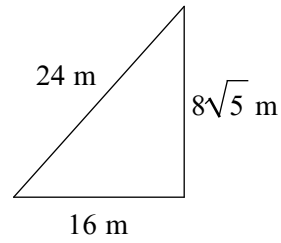

464)

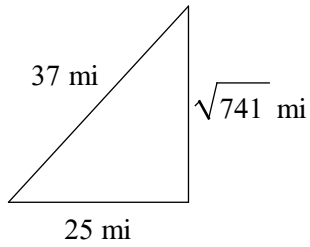

465)

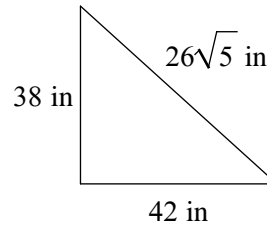

466)

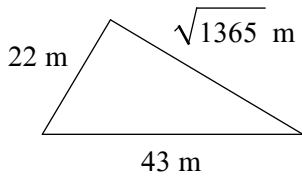

467)

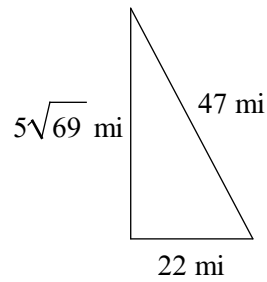

468)

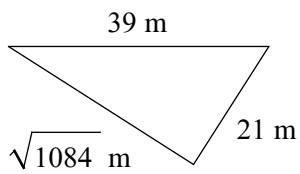

469)

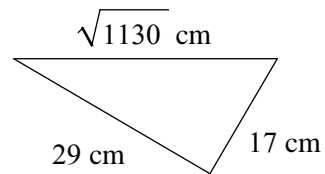

470)

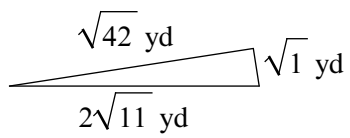

471)

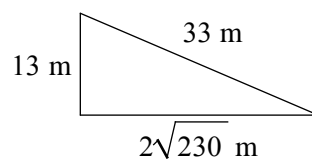

472)

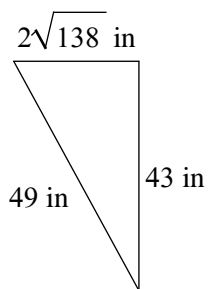

473)

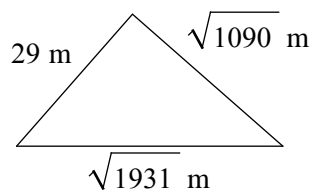

474)

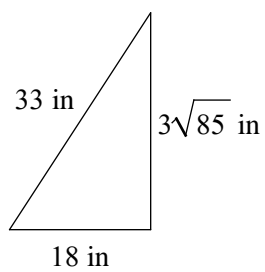

475)

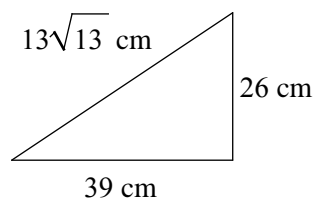

476)

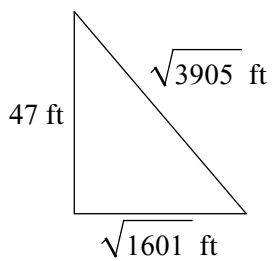

477)

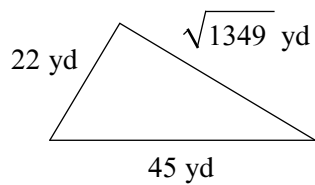

478)

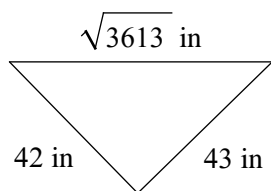

479)

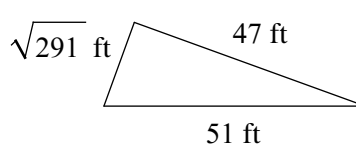

480)

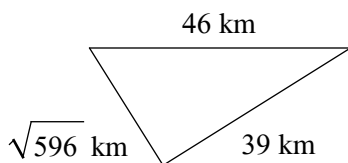

481)

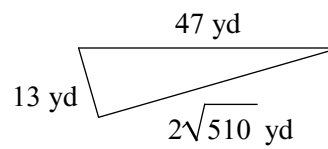

482)

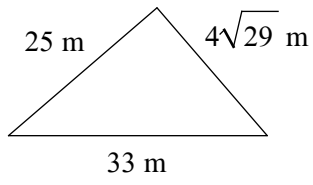

483)

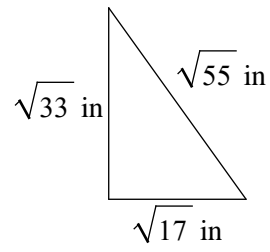

484)

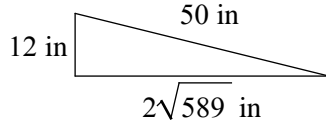

485)

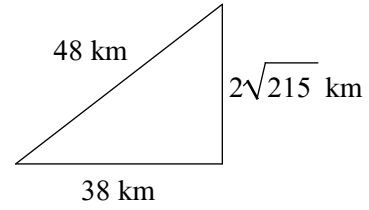

486)

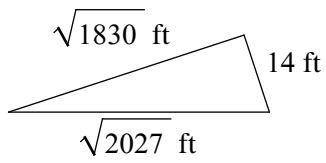

487)

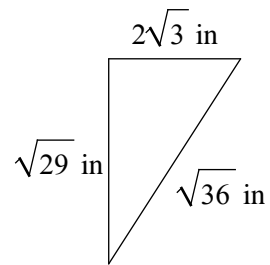

488)

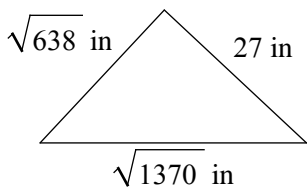

489)

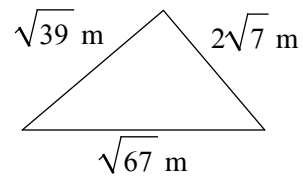

490)

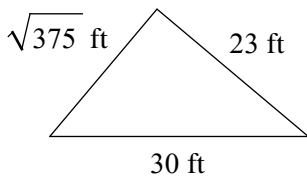

491)

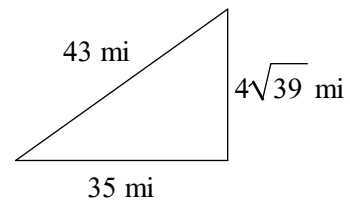

492)

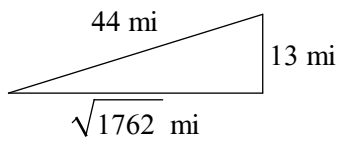

493)

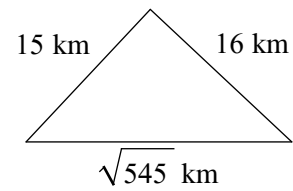

494)

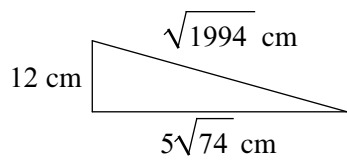

495)

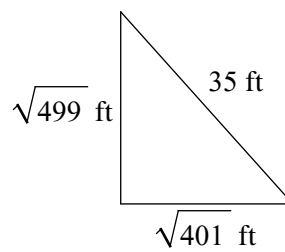

496)

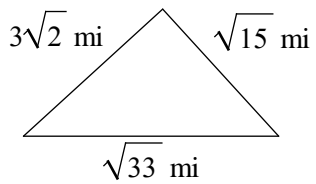

497)

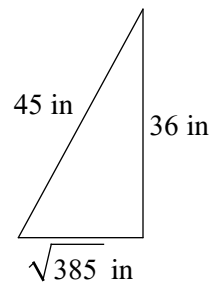

498)

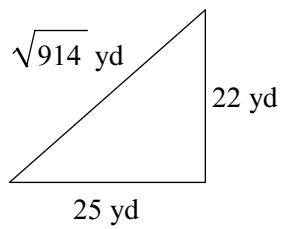

499)

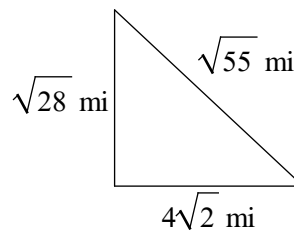

500)

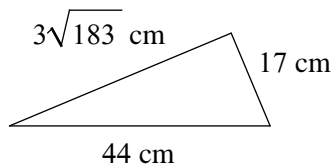

## Right triangles - The Pythagorean Theorem - Radicals

Find the missing side of triangle:

1)

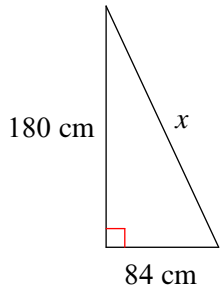

$$12\sqrt{274} \text{ cm}$$

2)

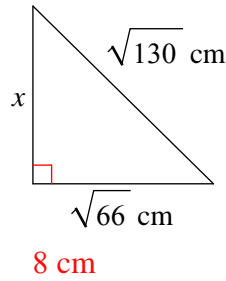

$$8 \text{ cm}$$

3)

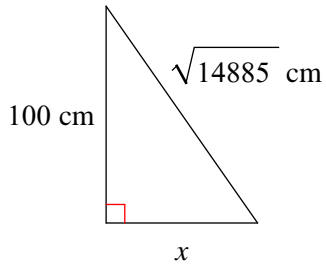

$$\sqrt{4885} \text{ cm}$$

4)

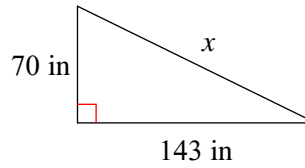

$$\sqrt{25349} \text{ in}$$

5)

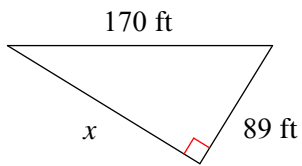

$$9\sqrt{259} \text{ ft}$$

6)

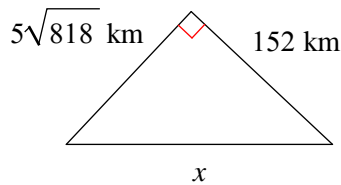

$$\sqrt{43554} \text{ km}$$

7)

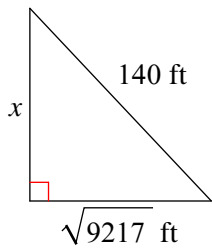

$$\sqrt{10383} \text{ ft}$$

8)

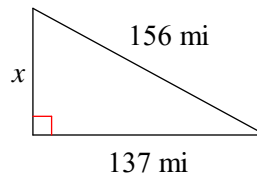

$$\sqrt{5567} \text{ mi}$$

9)

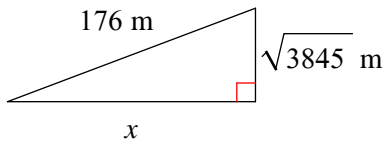

$$\sqrt{27131} \text{ m}$$

10)

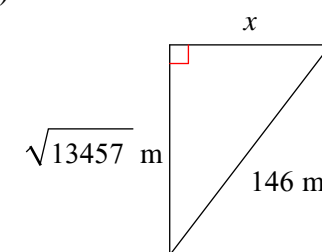

$$\sqrt{7859} \text{ m}$$

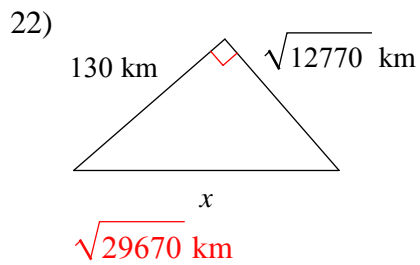
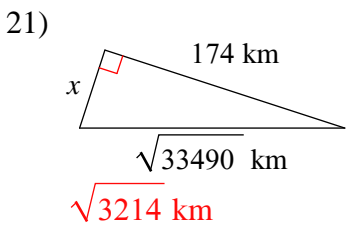
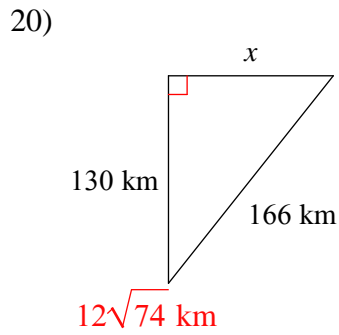
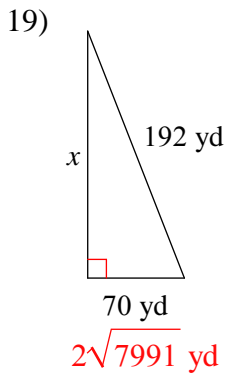
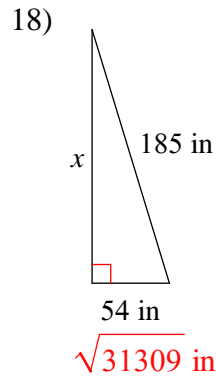
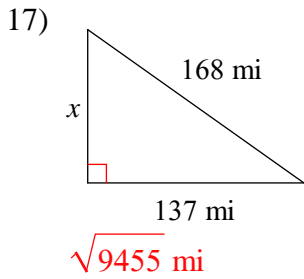
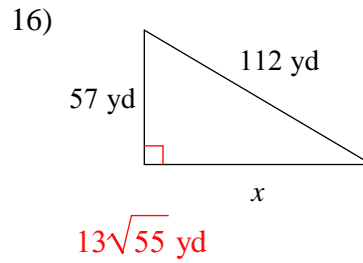
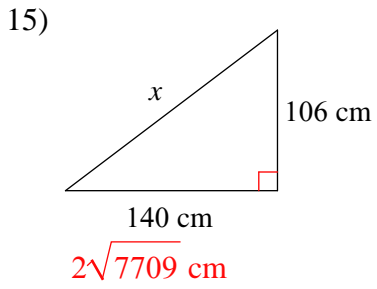
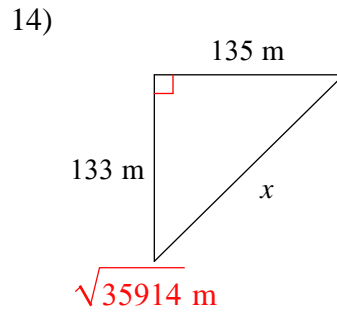
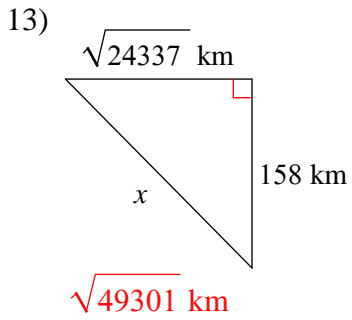
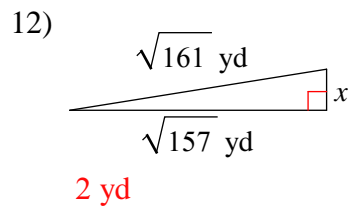
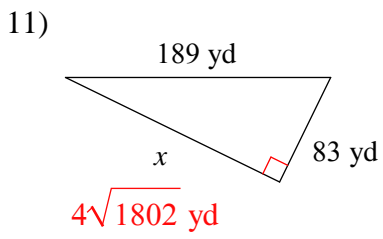

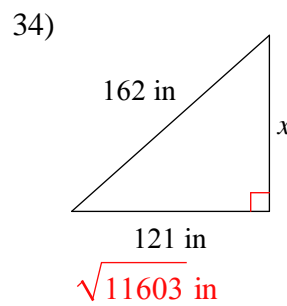
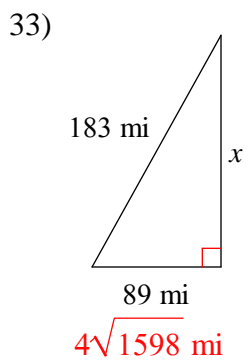
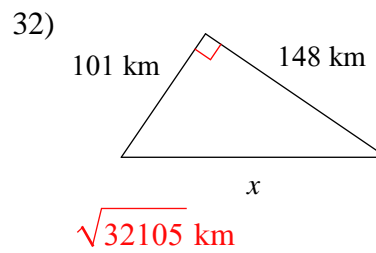
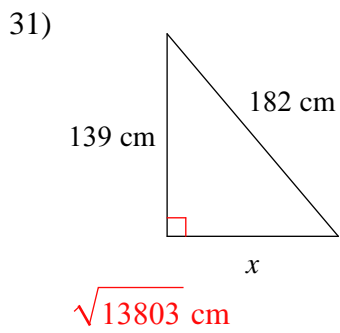
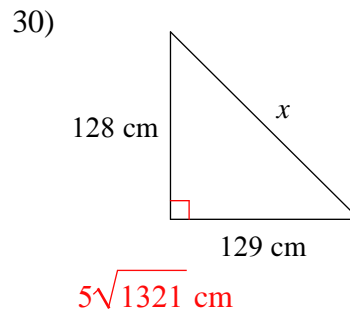
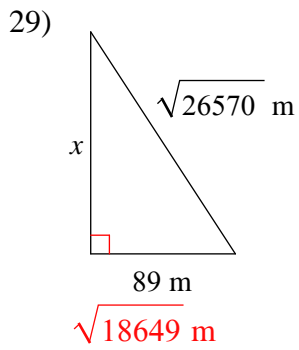
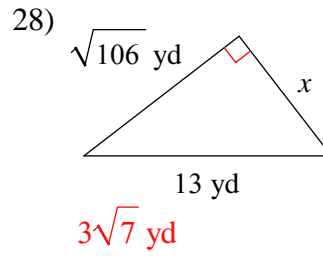
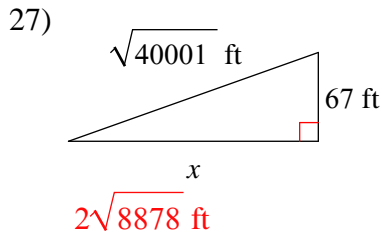
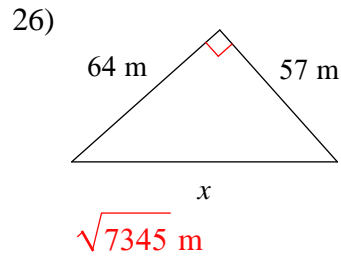
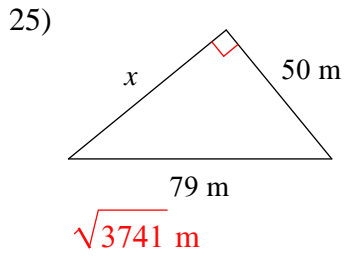
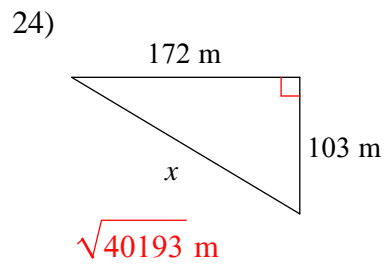
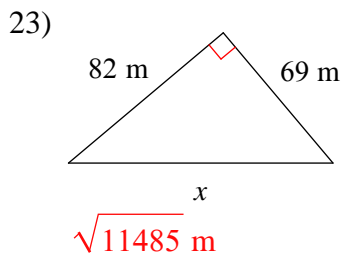



35)

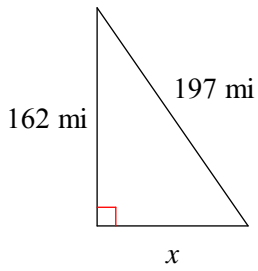

$$\sqrt{12565} \text{ mi}$$

36)

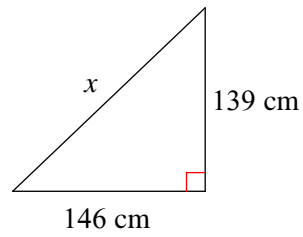

$$\sqrt{40637} \text{ cm}$$

37)

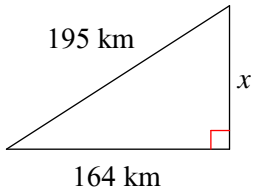

$$\sqrt{11129} \text{ km}$$

38)

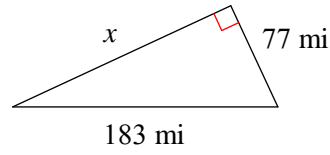

$$2\sqrt{6890} \text{ mi}$$

39)

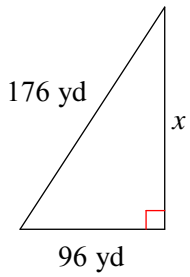

$$16\sqrt{85} \text{ yd}$$

40)

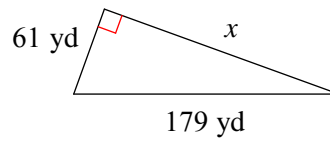

$$4\sqrt{1770} \text{ yd}$$

41)

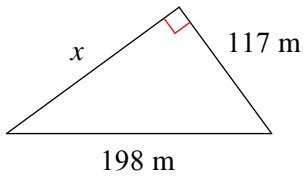

$$27\sqrt{35} \text{ m}$$

42)

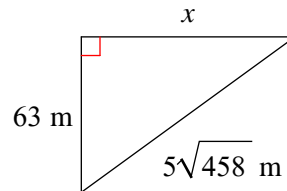

$$\sqrt{7481} \text{ m}$$

43)

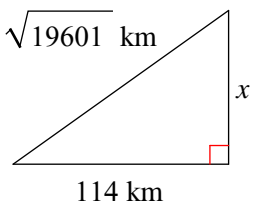

$$\sqrt{6605} \text{ km}$$

44)

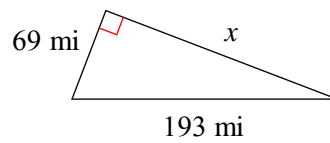

$$2\sqrt{8122} \text{ mi}$$

45)

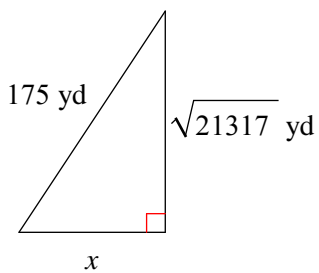

$$2\sqrt{2327} \text{ yd}$$

46)

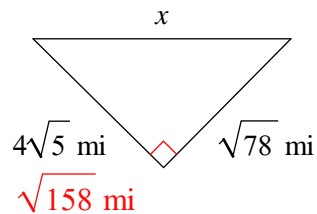

$$\sqrt{158} \text{ mi}$$

47)

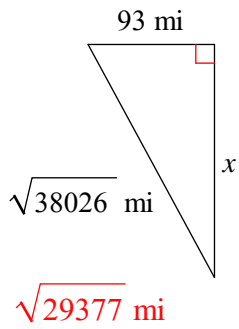

48)

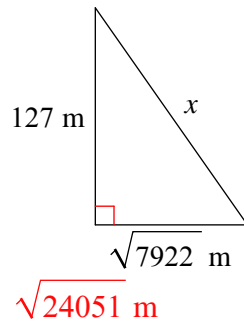

49)

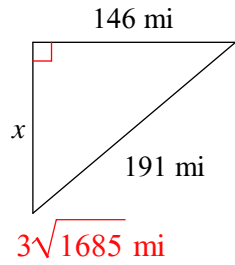

50)

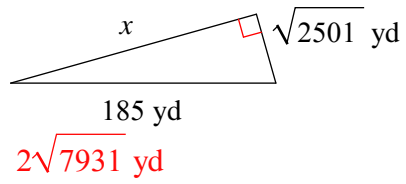

51)

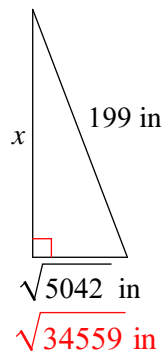

52)

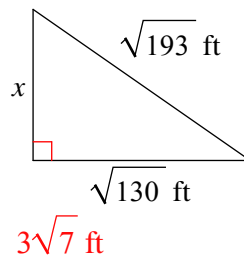

53)

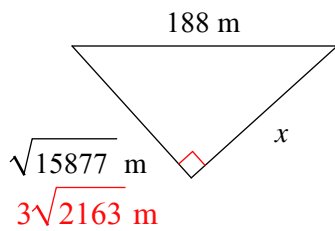

54)

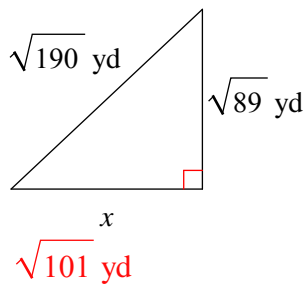

55)

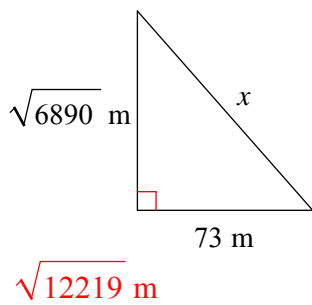

56)

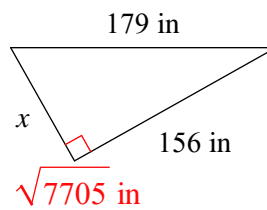

57)

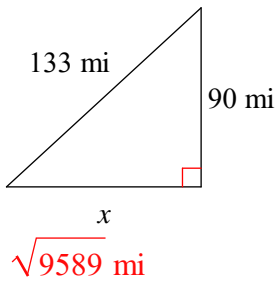

58)

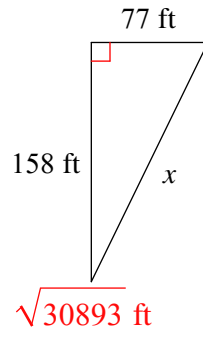

59)

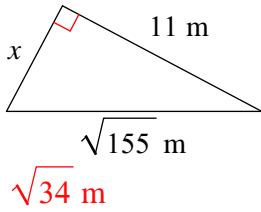

60)

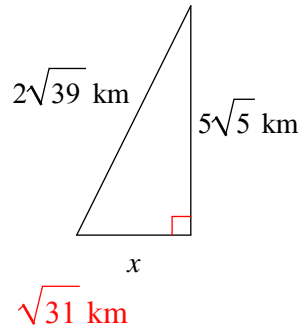

61)

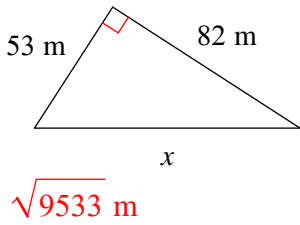

62)

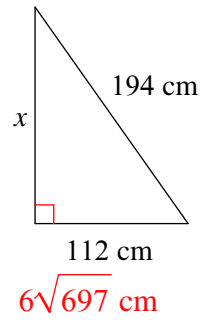

63)

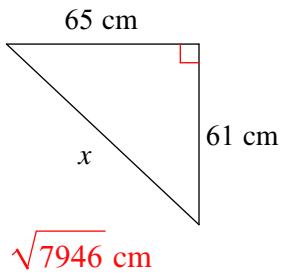

64)

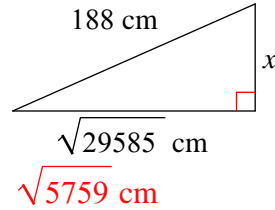

65)

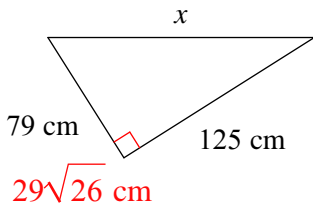

66)

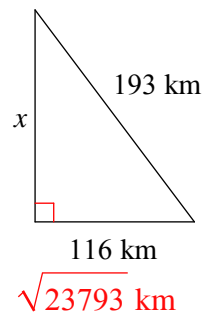

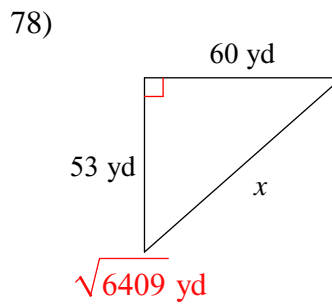
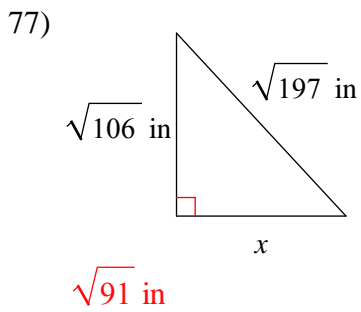
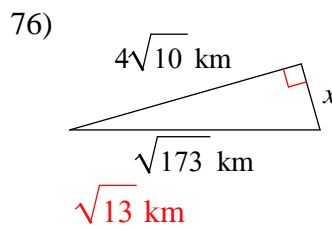
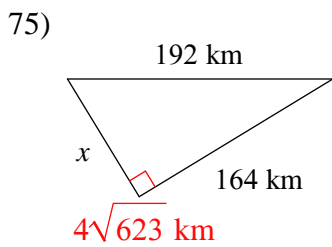
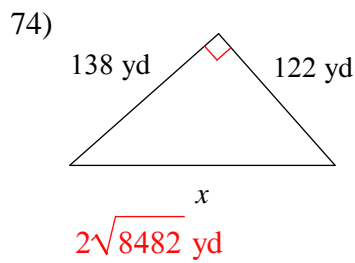
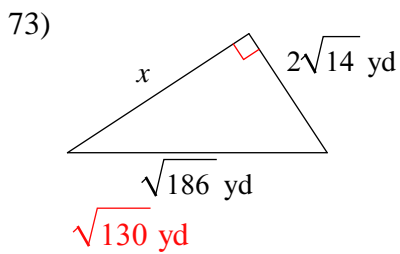
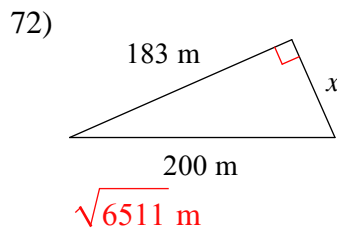
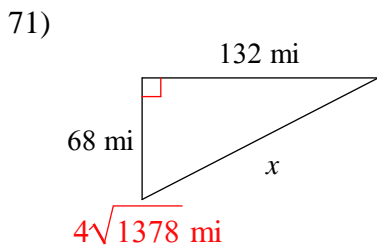
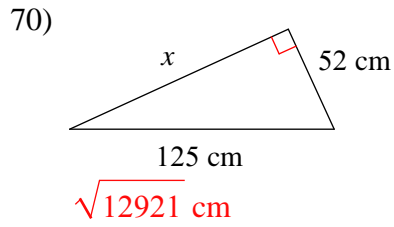
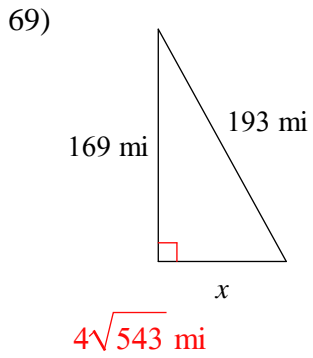
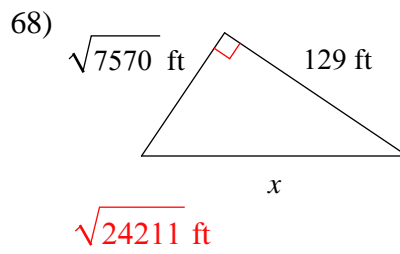
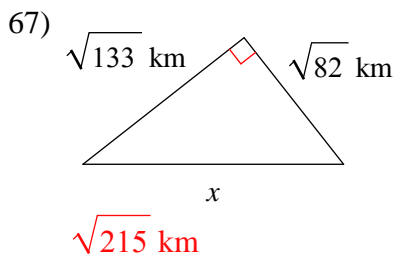

79)

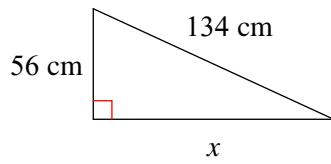

$$2\sqrt{3705} \text{ cm}$$

81)

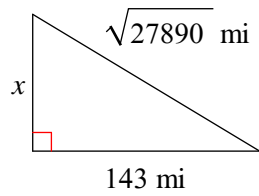

$$\sqrt{7441} \text{ mi}$$

83)

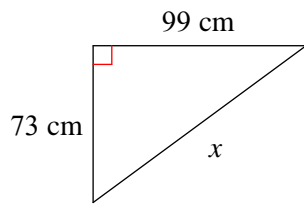

$$\sqrt{15130} \text{ cm}$$

85)

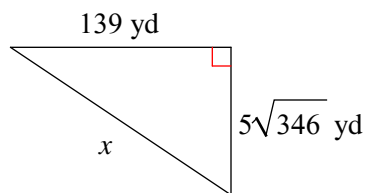

$$\sqrt{27971} \text{ yd}$$

87)

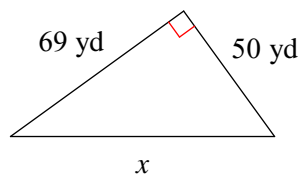

$$\sqrt{7261} \text{ yd}$$

89)

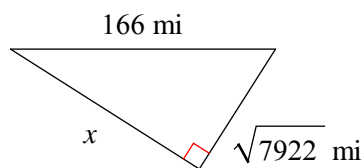

$$\sqrt{19634} \text{ mi}$$

80)

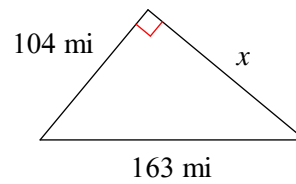

$$\sqrt{15753} \text{ mi}$$

82)

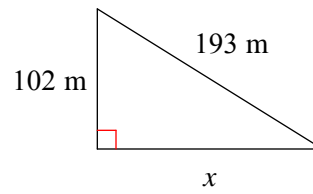

$$\sqrt{26845} \text{ m}$$

84)

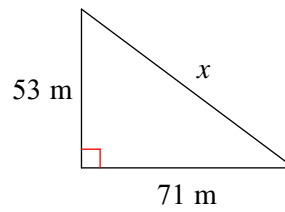

$$5\sqrt{314} \text{ m}$$

86)

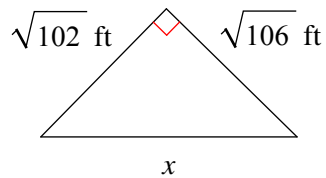

$$4\sqrt{13} \text{ ft}$$

88)

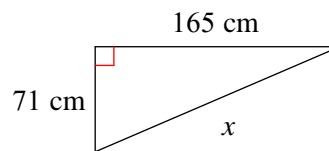

$$\sqrt{32266} \text{ cm}$$

90)

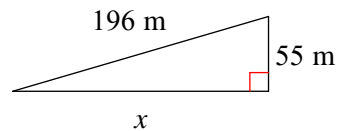

$$\sqrt{35391} \text{ m}$$

91)

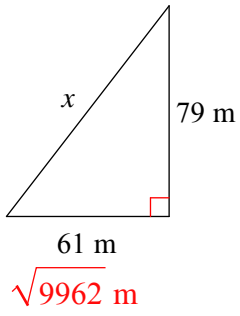

92)

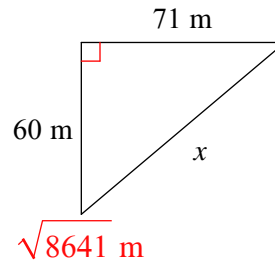

93)

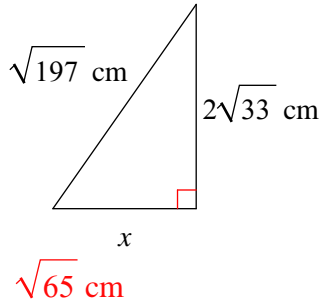

94)

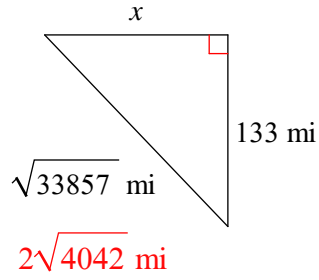

95)

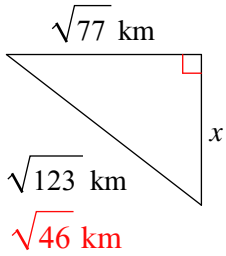

96)

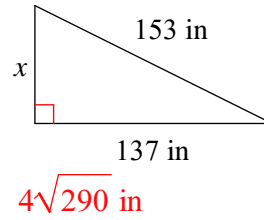

97)

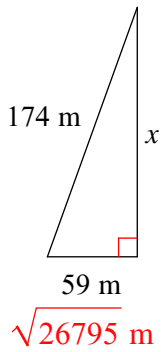

98)

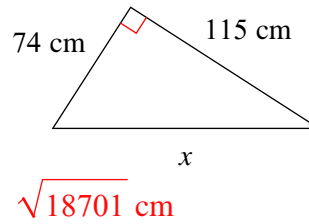

99)

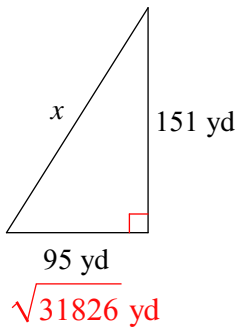

100)

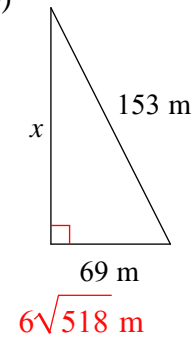

State if it is right triangle:

101)

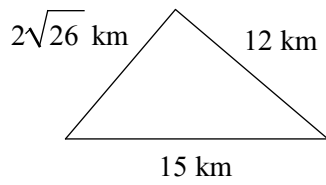

No

102)

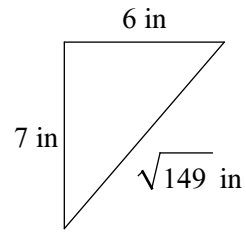

No

103)

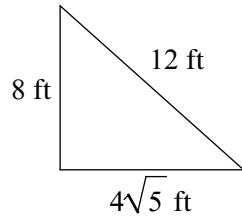

Yes

104)

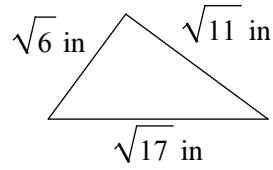

Yes

105)

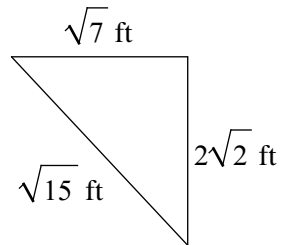

Yes

106)

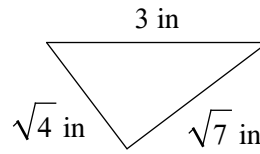

No

107)

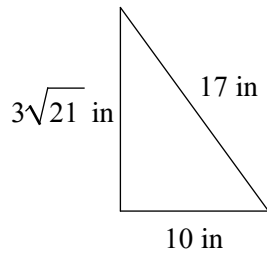

Yes

108)

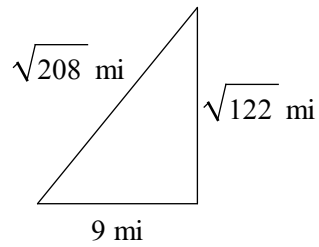

No

109)

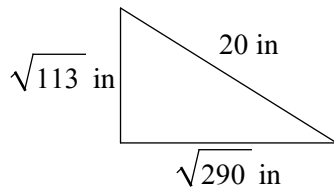

No

110)

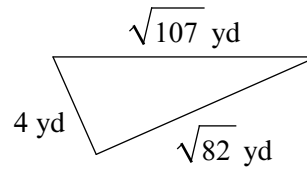

No

111)

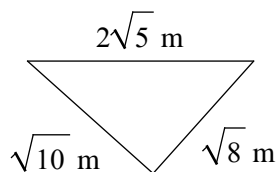

No

112)

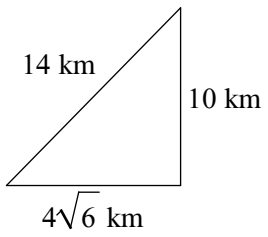

Yes

113)

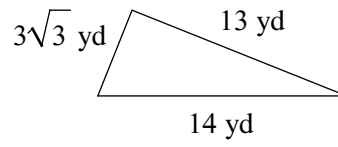

Yes

114)

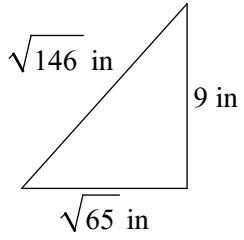

Yes

115)

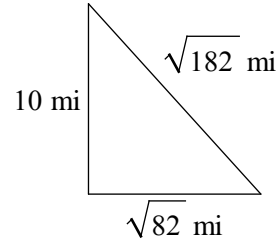

Yes

116)

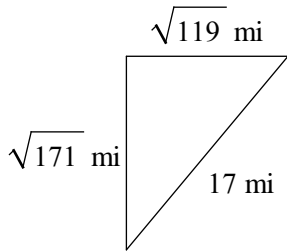

No

117)

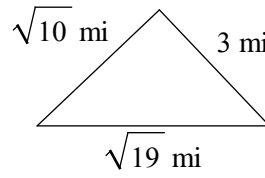

Yes

118)

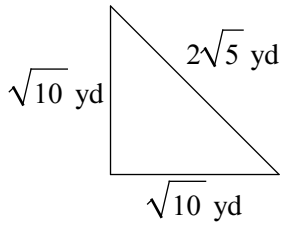

Yes

119)

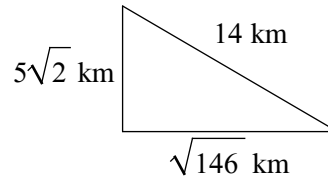

Yes

120)

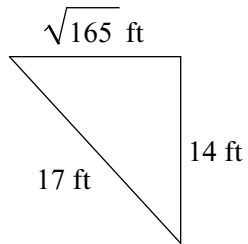

No

121)

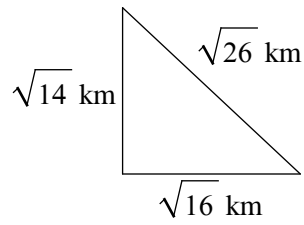

No



122)

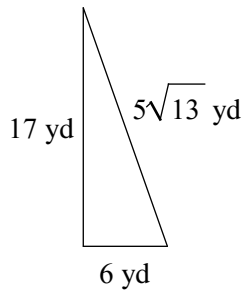

Yes

123)

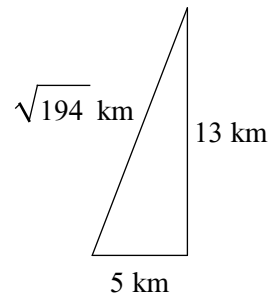

Yes

124)

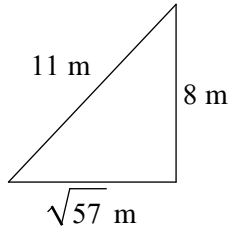

Yes

125)

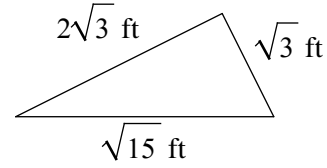

Yes

126)

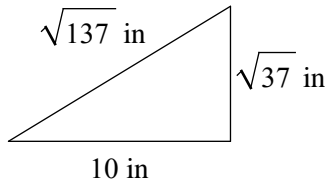

Yes

127)

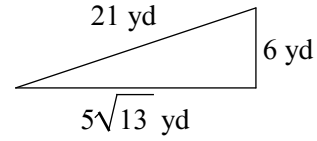

No

128)

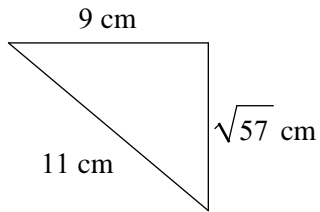

No

129)

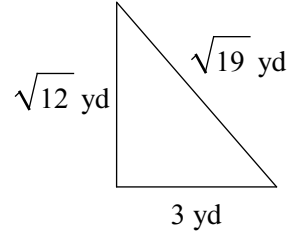

No

130)

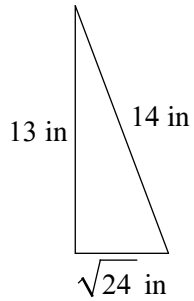

No

131)

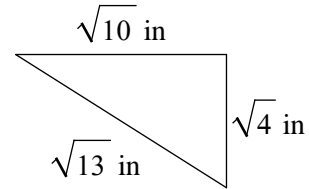

No

132)

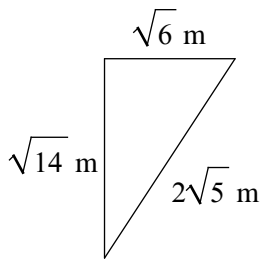

Yes

133)

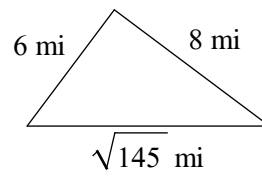

No

134)

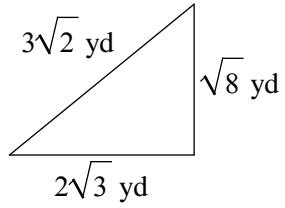

No

135)

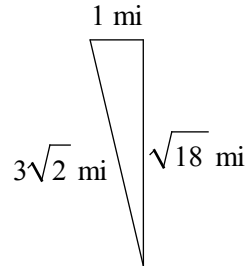

No

136)

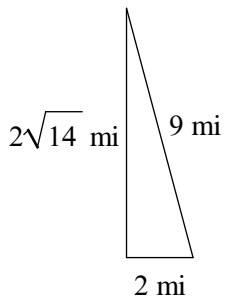

No

137)

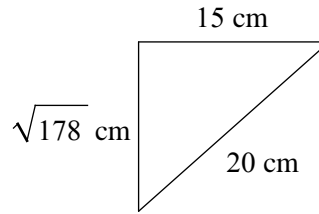

No

138)

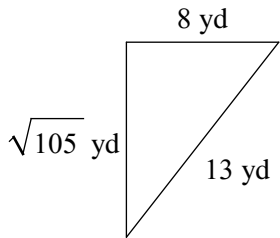

Yes

139)

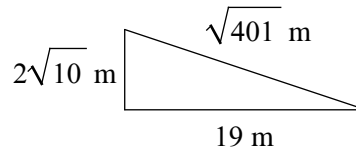

Yes

140)

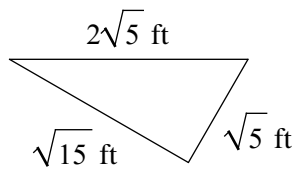

Yes

141)

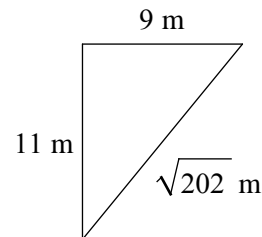

Yes

142)

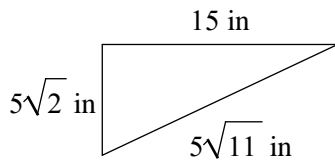

Yes

143)

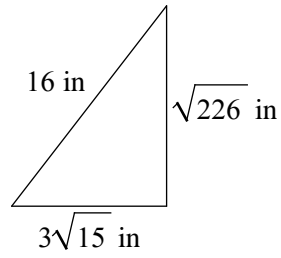

No

144)

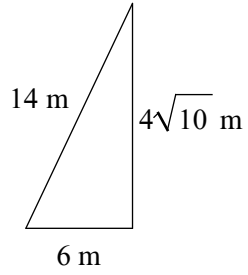

Yes

145)

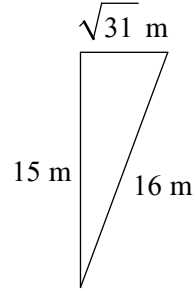

Yes

146)

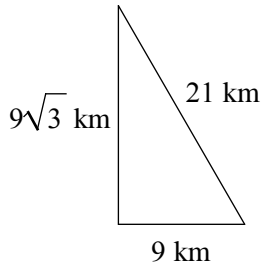

No

147)

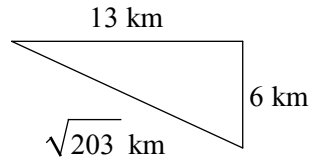

No

148)

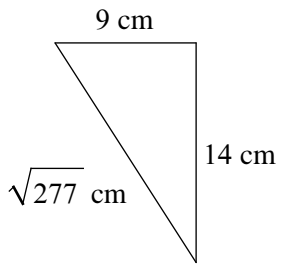

Yes

149)

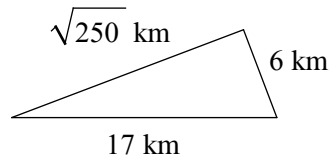

No

150)

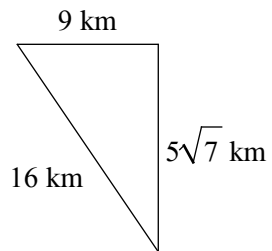

Yes

151)

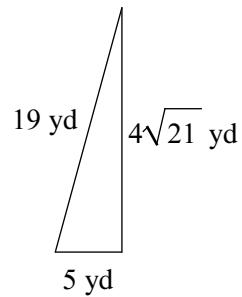

Yes

152)

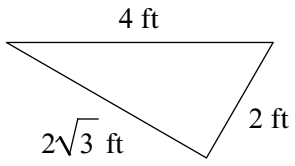

Yes

153)

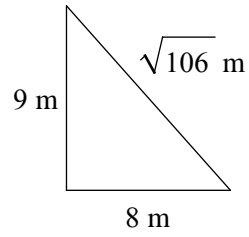

No

154)

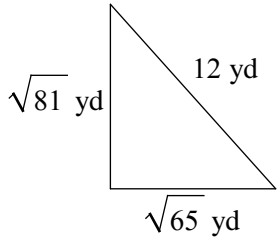

No

155)

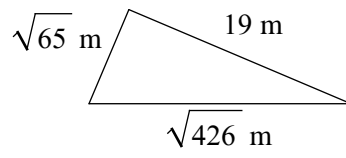

Yes

156)

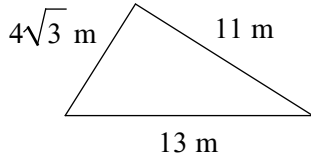

Yes

157)

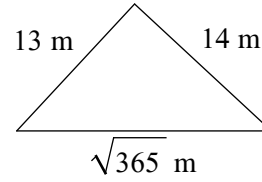

Yes

158)

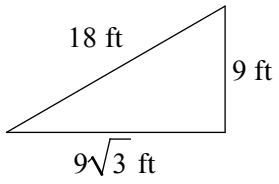

Yes

159)

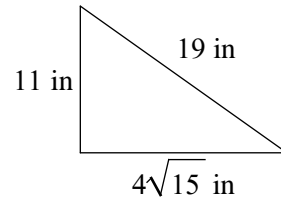

Yes

160)

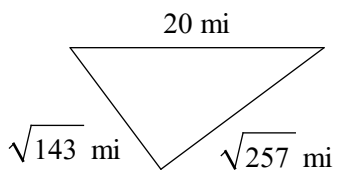

Yes

161)

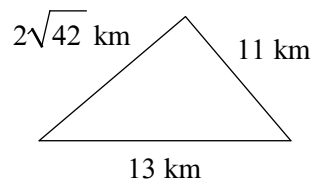

No

162)

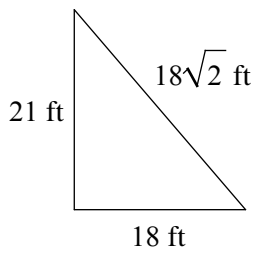

No

163)

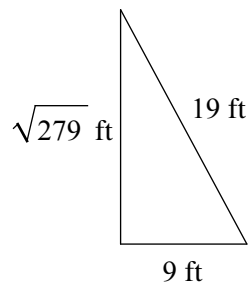

No

164)

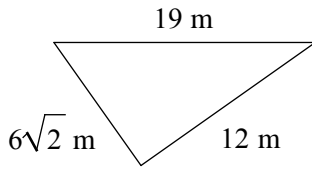

No

165)

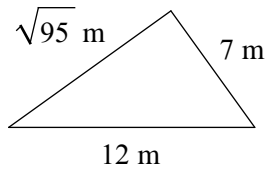

Yes

166)

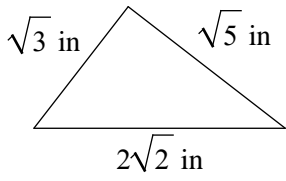

Yes

167)

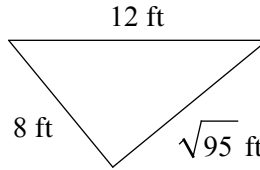

No

168)

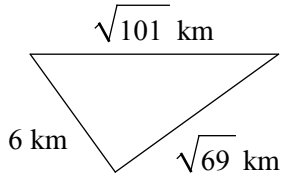

No

169)

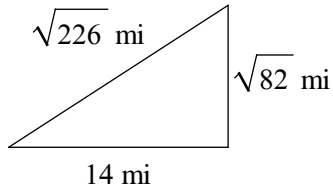

No

170)

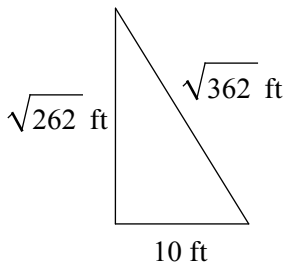

No

171)

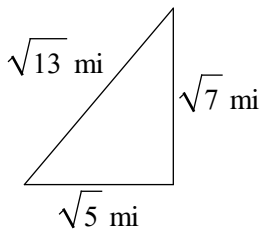

No

172)

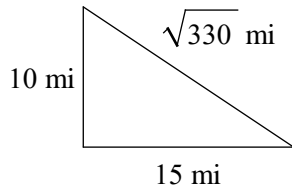

No

173)

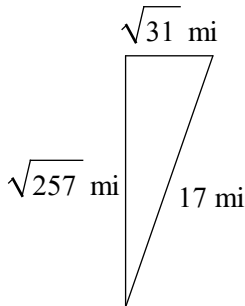

No

174)

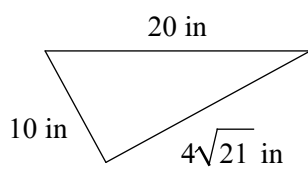

No

175)

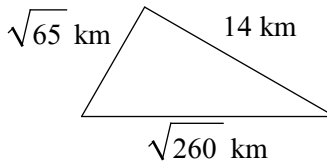

No

176)

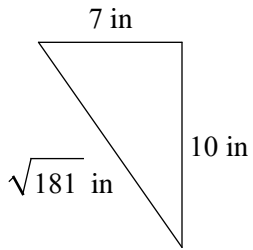

No

177)

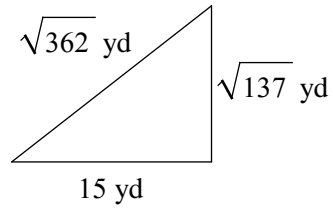

Yes

178)

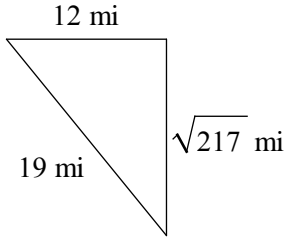

Yes

179)

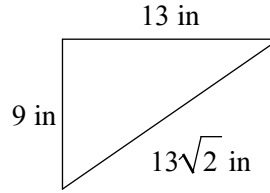

No

180)

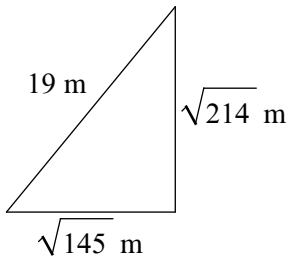

No

181)

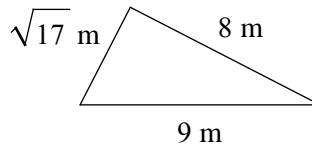

Yes

182)

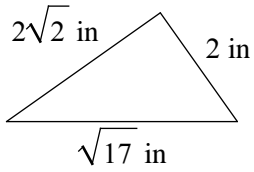

No

183)

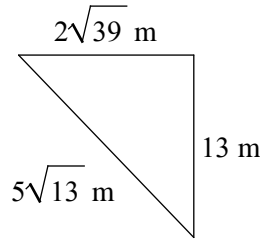

Yes

184)

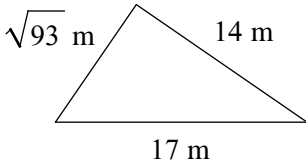

Yes

185)

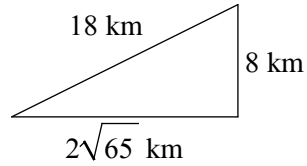

Yes

186)

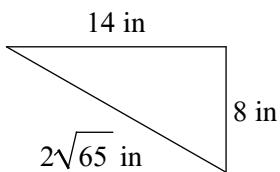

Yes

187)

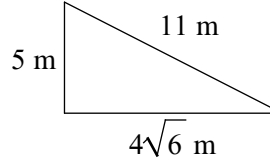

Yes

188)

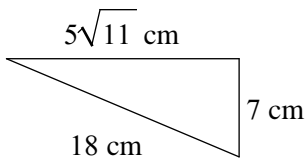

Yes

189)

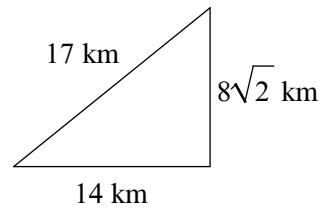

No

190)

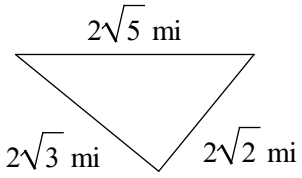

Yes

191)

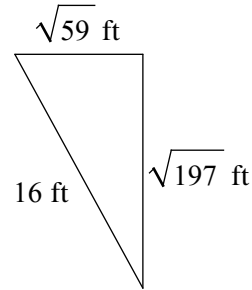

Yes

192)

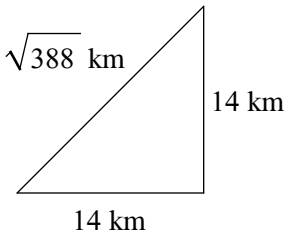

No

193)

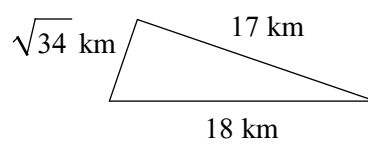

No

194)

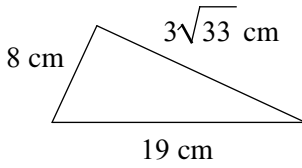

Yes

195)

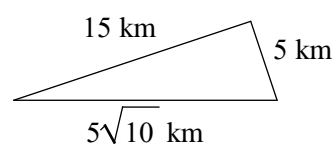

Yes

196)

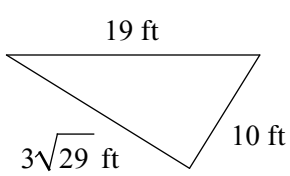

Yes

197)

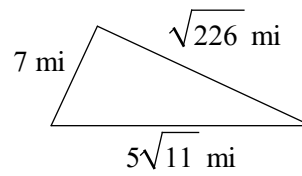

Yes

198)

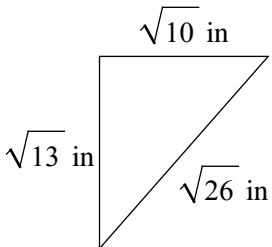

No

199)

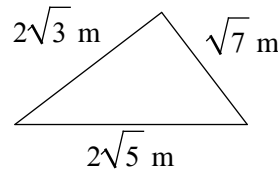

No

200)

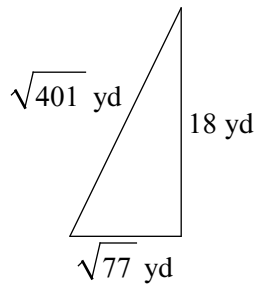

Yes

201)

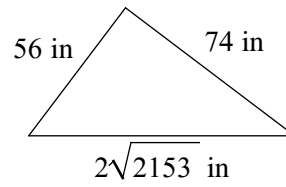

No

202)

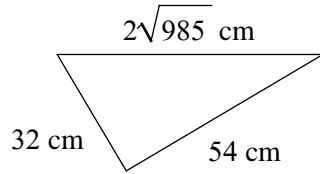

No

203)

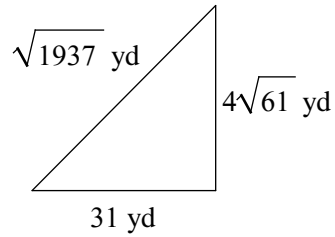

Yes

204)

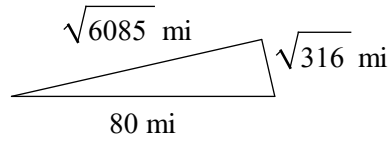

No

205)

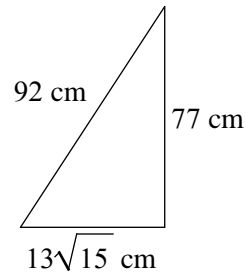

Yes

206)

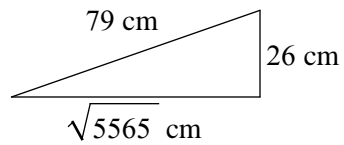

No

207)

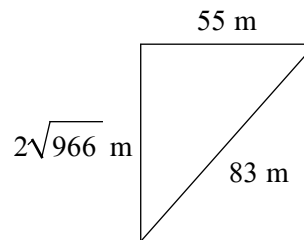

Yes

208)

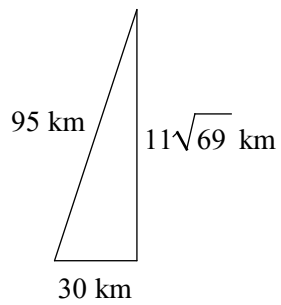

No

209)

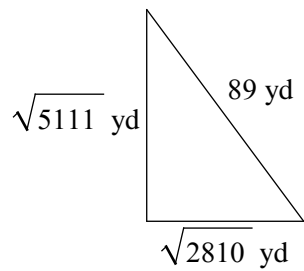

Yes



210)

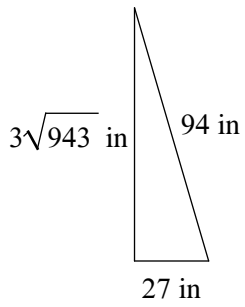

No

211)

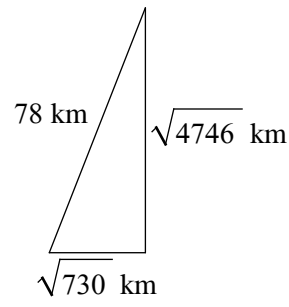

No

212)

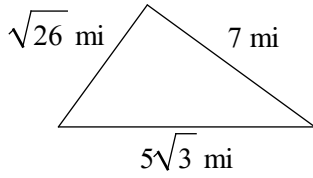

Yes

213)

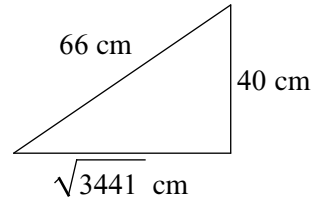

No

214)

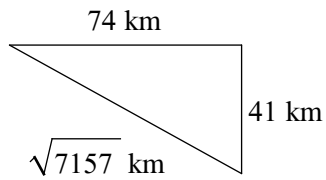

Yes

215)

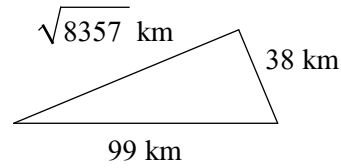

Yes

216)

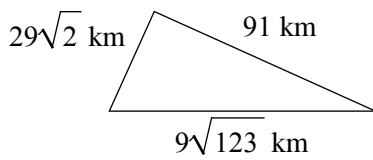

No

217)

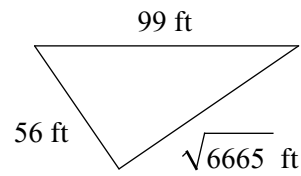

Yes

218)

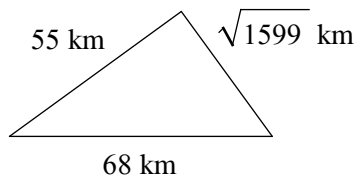

Yes

219)

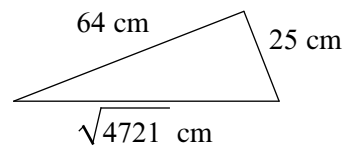

No

220)

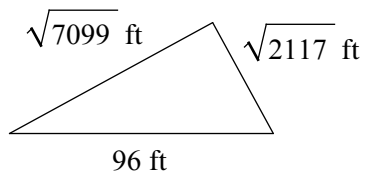

Yes

221)

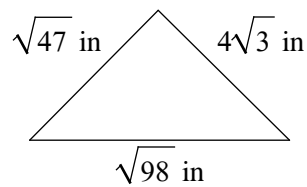

No

222)

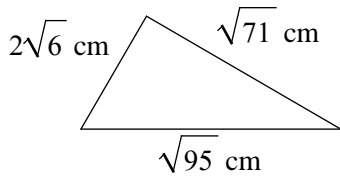

Yes

223)

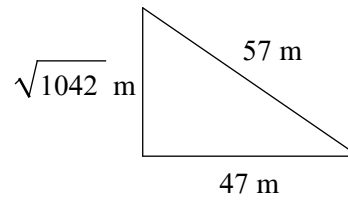

No

224)

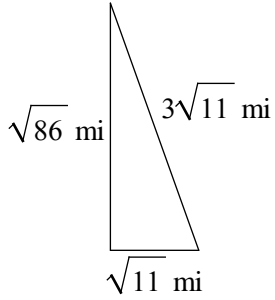

No

225)

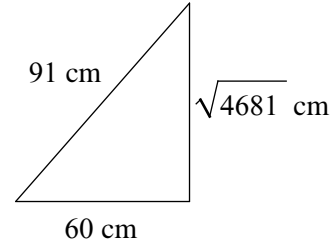

Yes

226)

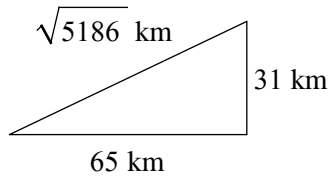

No

227)

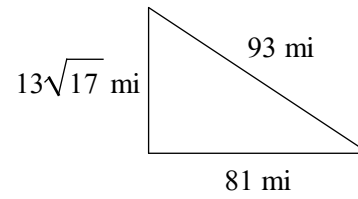

No

228)

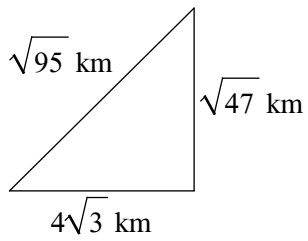

Yes

229)

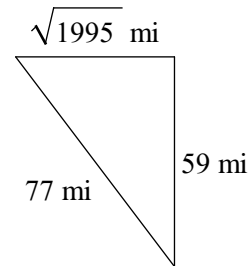

No

230)

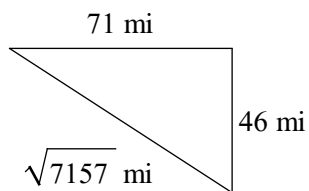

Yes

231)

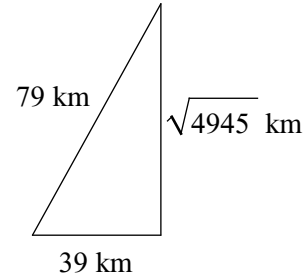

No

232)

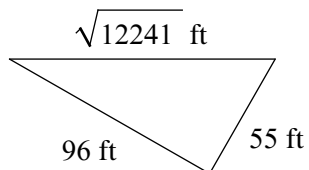

No

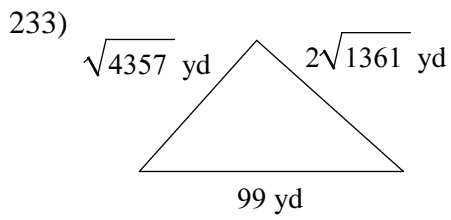

Yes

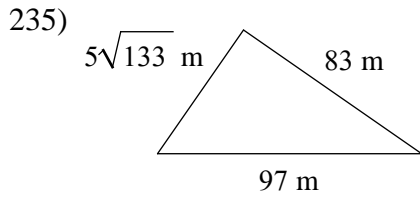

No

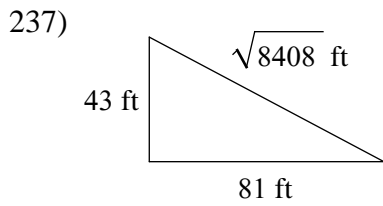

No

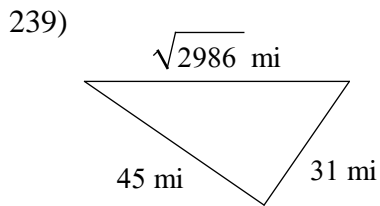

No

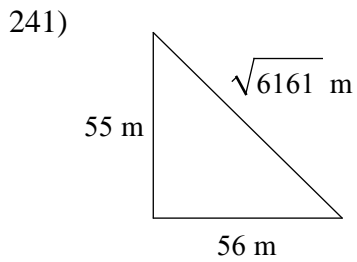

No

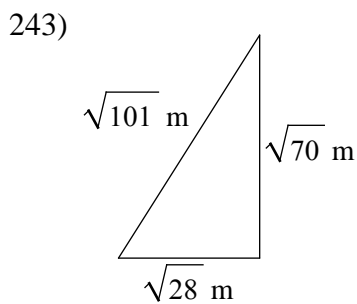

No

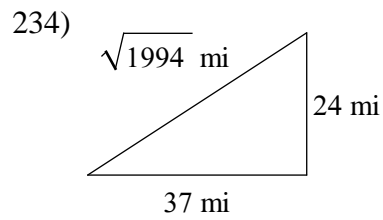

No

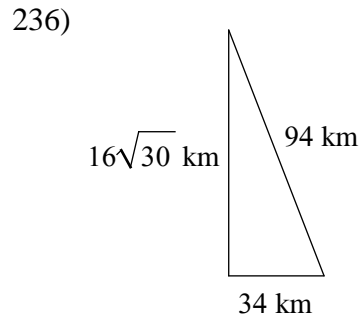

Yes

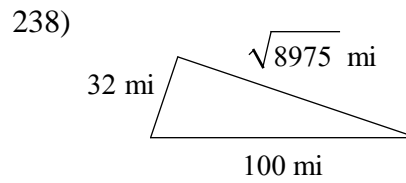

No

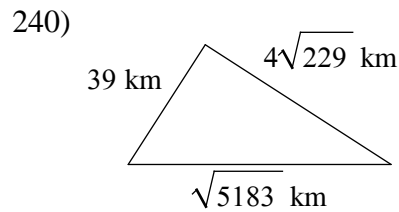

No

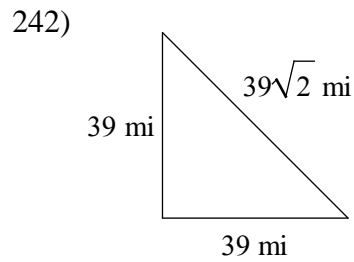

No

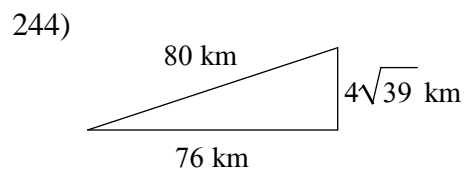

Yes

245)

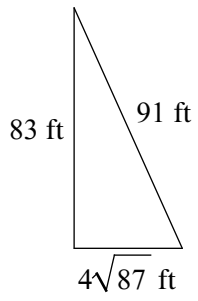

Yes

246)

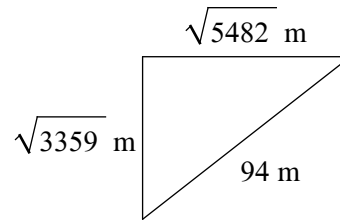

No

247)

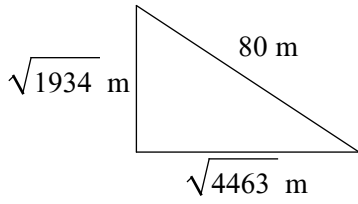

No

248)

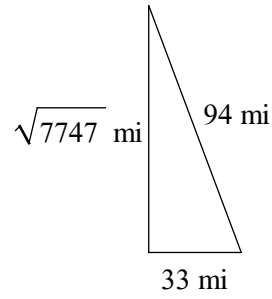

Yes

249)

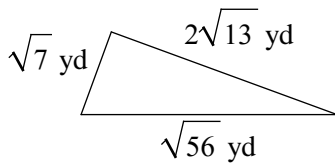

No

250)

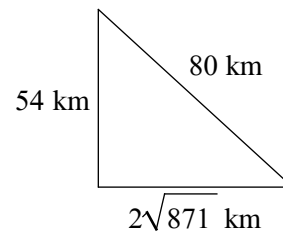

Yes

251)

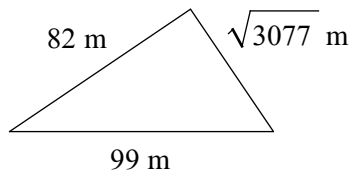

Yes

252)

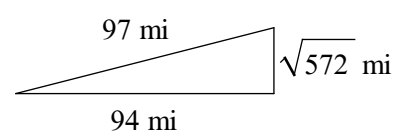

No

253)

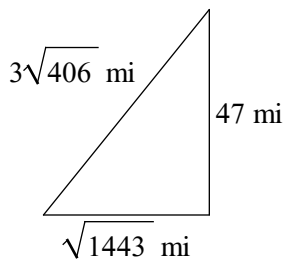

No

254)

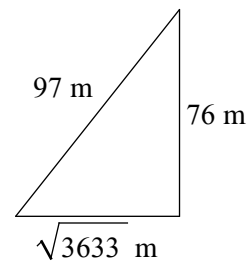

Yes

255)

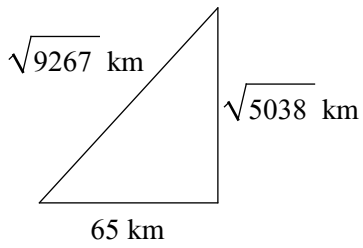

No

256)

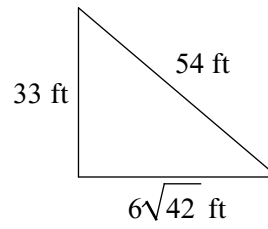

No

257)

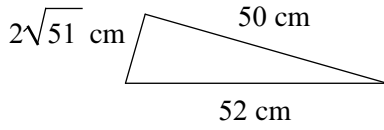

Yes

258)

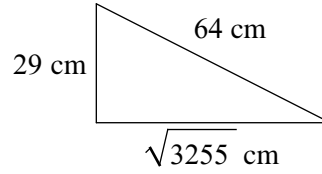

Yes

259)

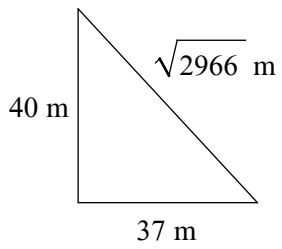

No

260)

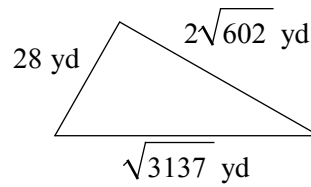

No

261)

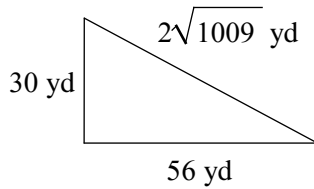

No

262)

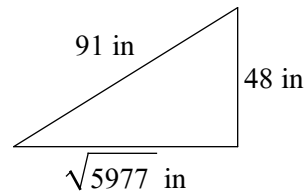

Yes

263)

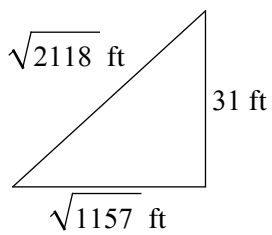

Yes

264)

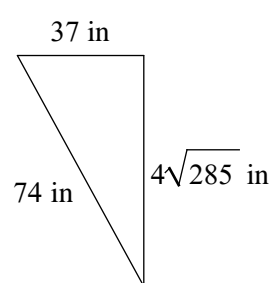

No

265)

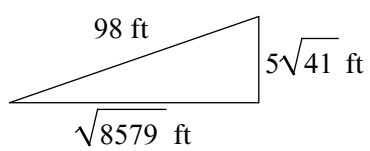

No

266)

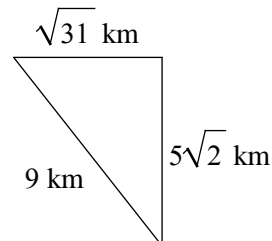

Yes

267)

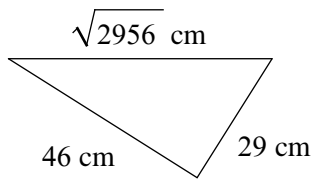

No

268)

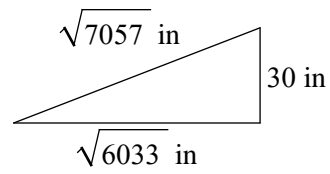

No

269)

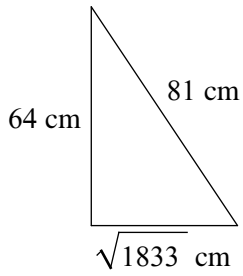

No

270)

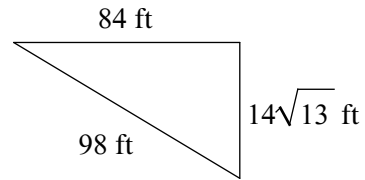

Yes

271)

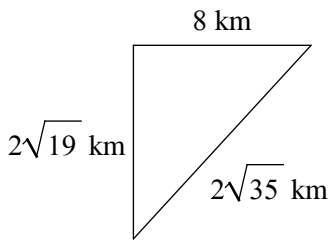

Yes

272)

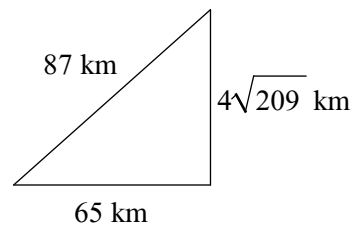

Yes

273)

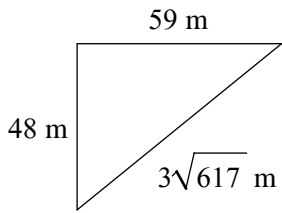

No

274)

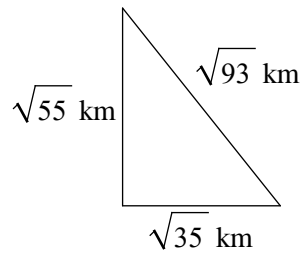

No

275)

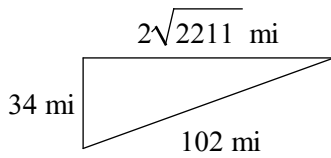

No

276)

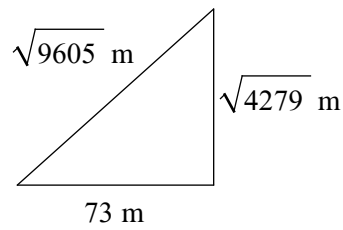

No

277)

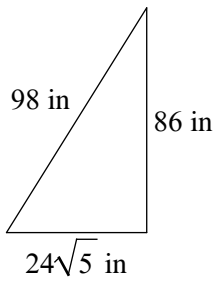

No

278)

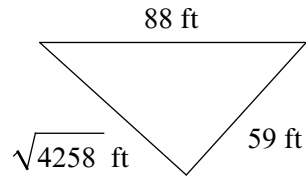

No

279)

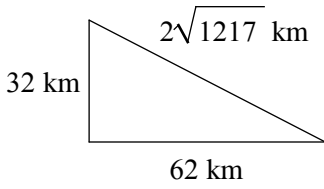

No

280)

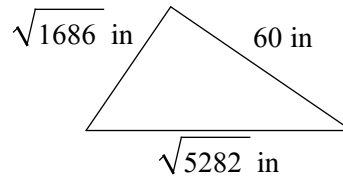

No

281)

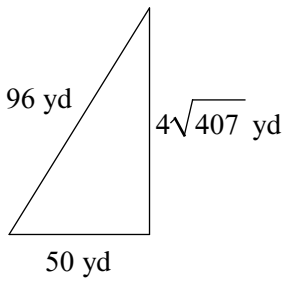

No

282)

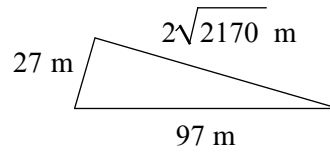

Yes

283)

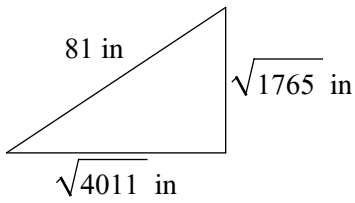

No

284)

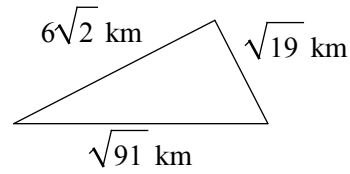

Yes

285)

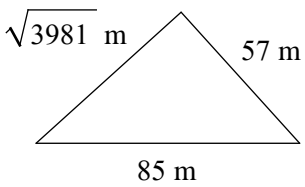

No

286)

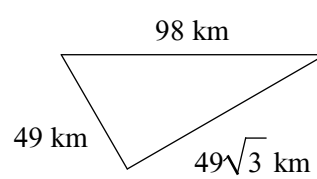

Yes

287)

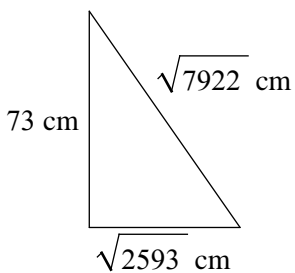

No

288)

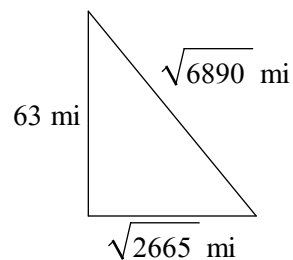

No

289)

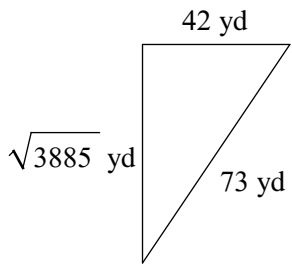

No

290)

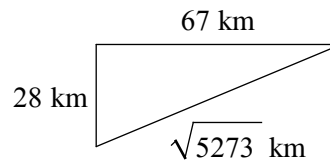

No

291)

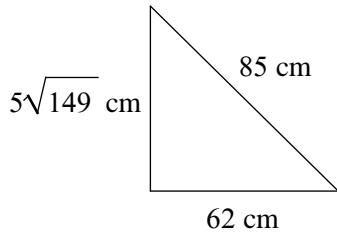

No

292)

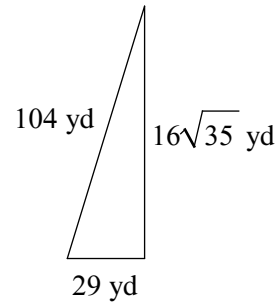

No

293)

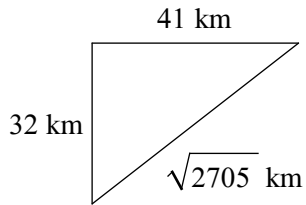

Yes

294)

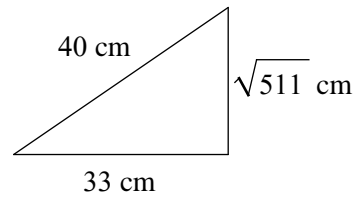

Yes

295)

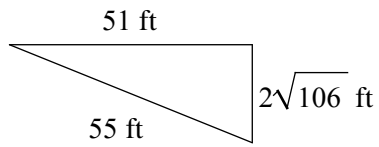

Yes

296)

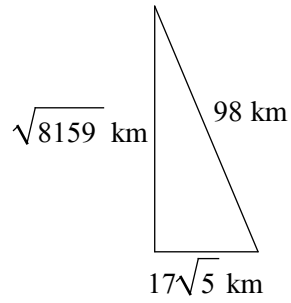

No

297)

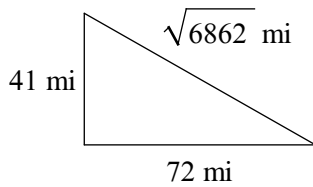

No

298)

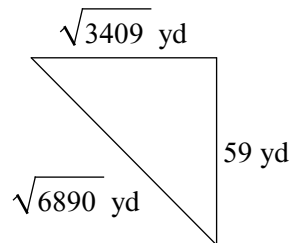

No



299)

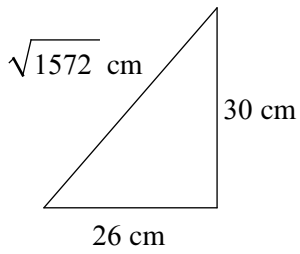

No

300)

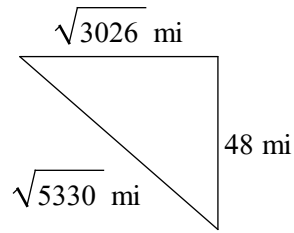

Yes

What type of triangle is this? Acute, obtuse or right?

301)

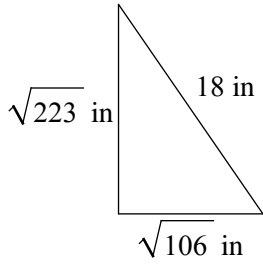

Acute

302)

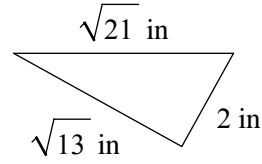

Obtuse

303)

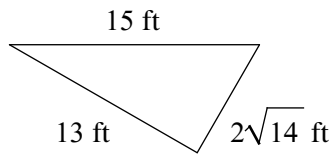

Right

304)

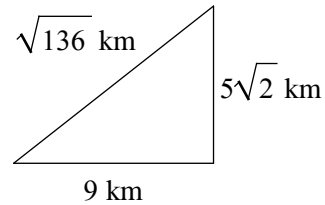

Obtuse

305)

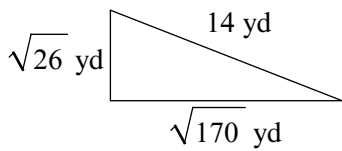

Acute

306)

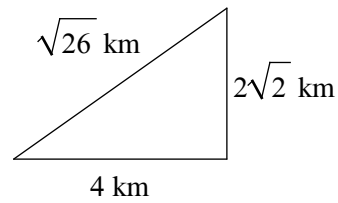

Obtuse

307)

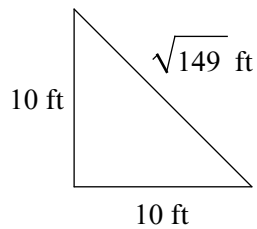

Acute

308)

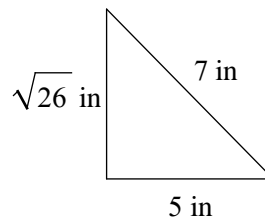

Acute

309)

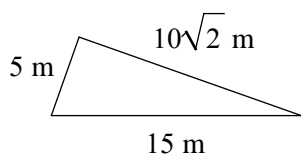

Acute

310)

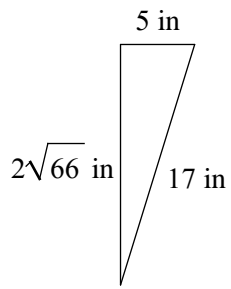

Acute

311)

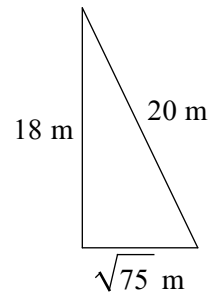

Obtuse

312)

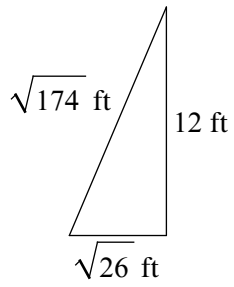

Obtuse

313)

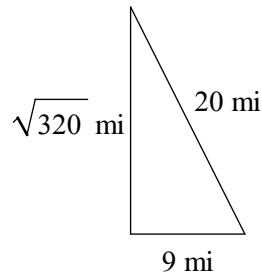

Acute

314)

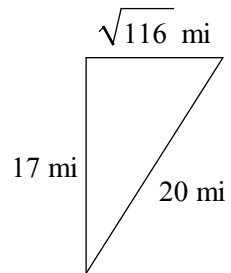

Acute

315)

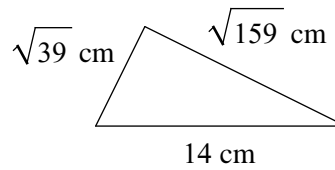

Acute

316)

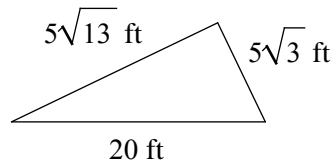

Right

317)

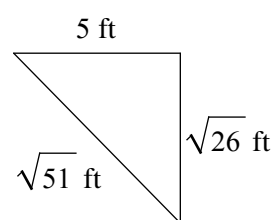

Obtuse

318)

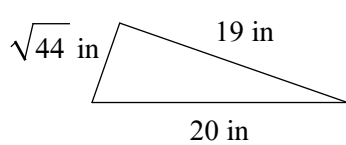

Acute

319)

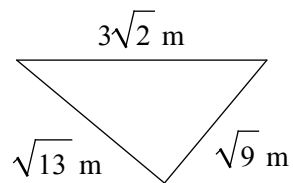

Acute

320)

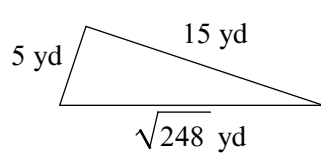

Acute

321)

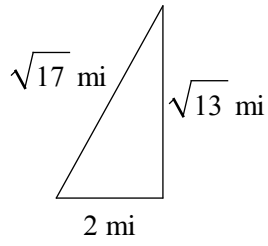

Right

322)

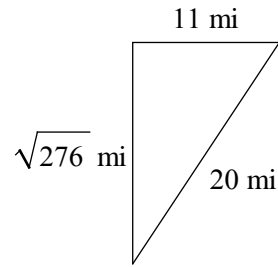

Obtuse

323)

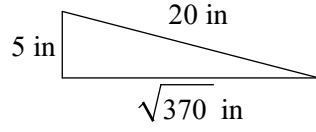

Obtuse

324)

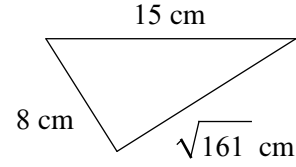

Right

325)

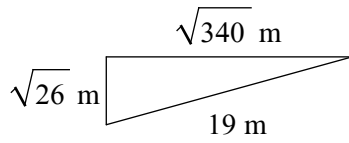

Acute

326)

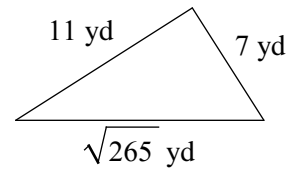

Obtuse

327)

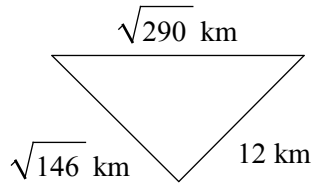

Obtuse

328)

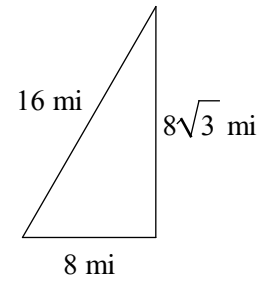

Obtuse

329)

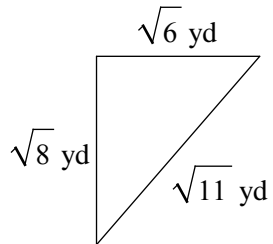

Acute

330)

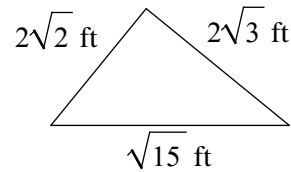

Acute

331)

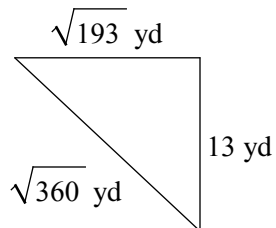

Acute

332)

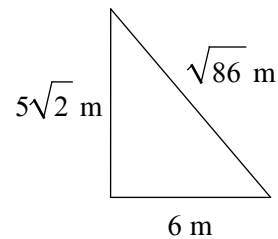

Right

333)

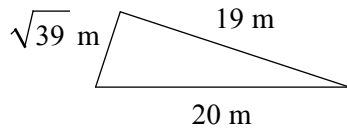

Right

334)

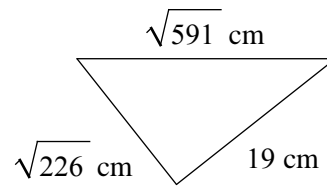

Obtuse

335)

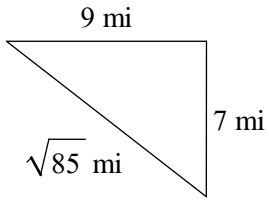

Acute

336)

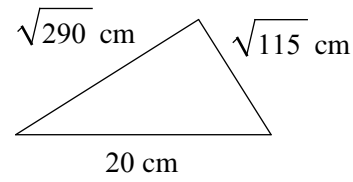

Acute

337)

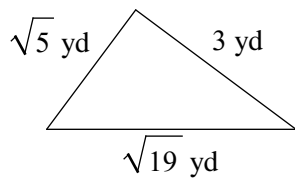

Obtuse

338)

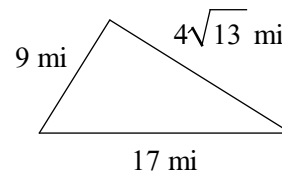

Right

339)

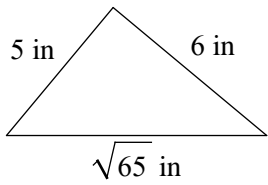

Obtuse

340)

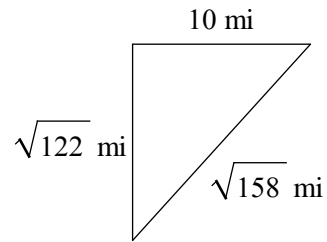

Acute

341)

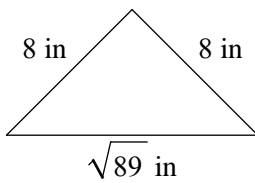

Acute

342)

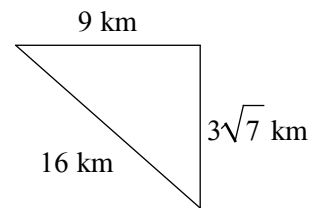

Obtuse

343)

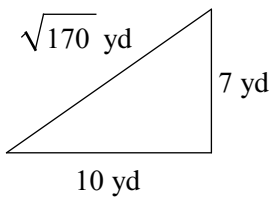

Obtuse

344)

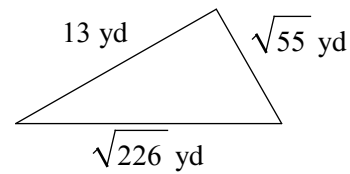

Obtuse

345)

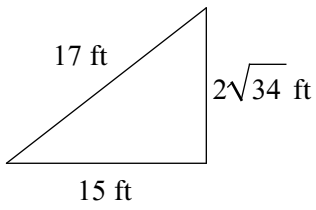

Acute

346)

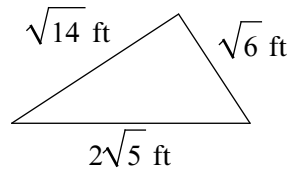

Obtuse

347)

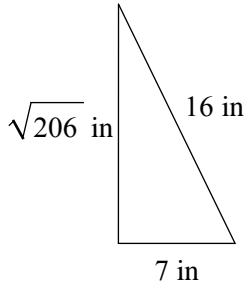

Obtuse

348)

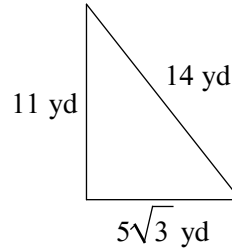

Right

349)

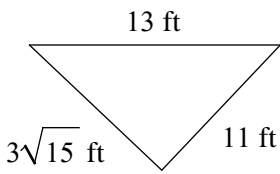

Acute

350)

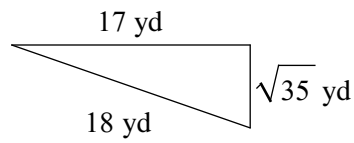

Right

351)

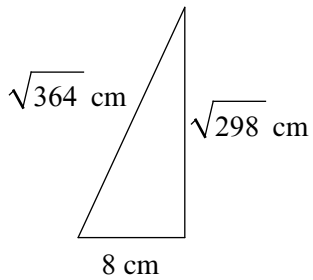

Obtuse

352)

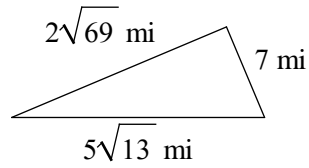

Right

353)

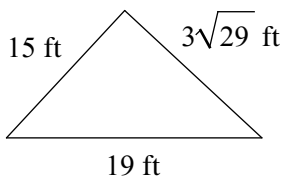

Acute

354)

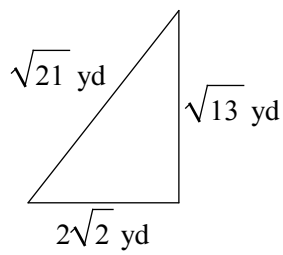

Right

355)

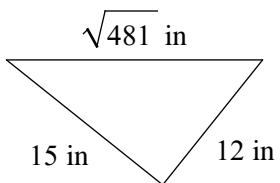

Obtuse

356)

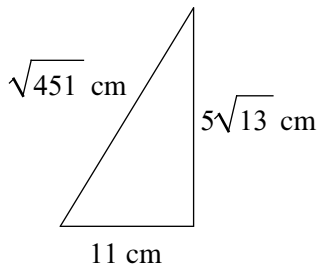

Obtuse

357)

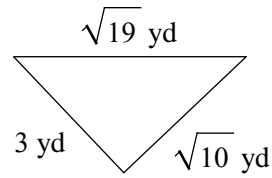

Obtuse

358)

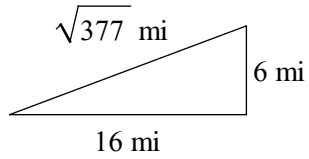

Obtuse

359)

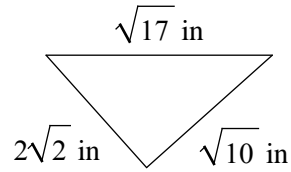

Acute

360)

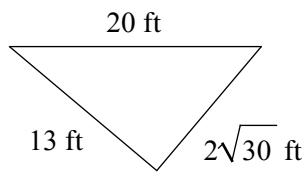

Obtuse

361)

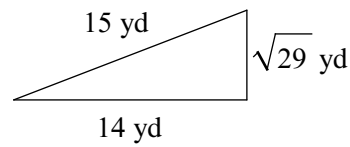

Right

362)

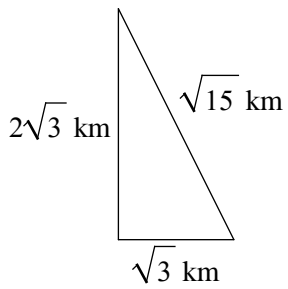

Obtuse

363)

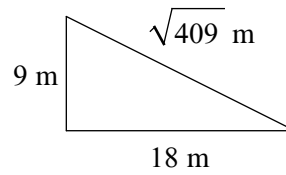

Obtuse

364)

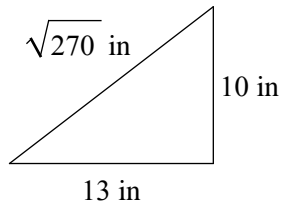

Obtuse

365)

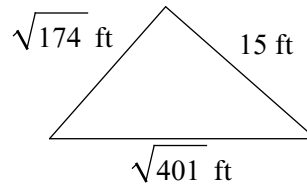

Obtuse

366)

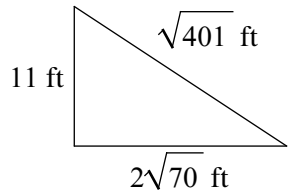

Obtuse

367)

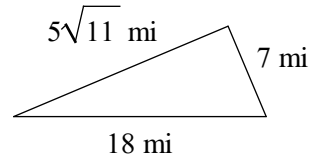

Obtuse

368)

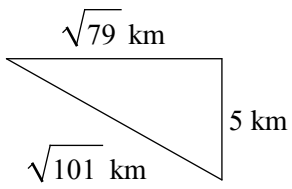

Acute

369)

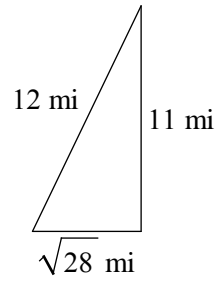

Acute

370)

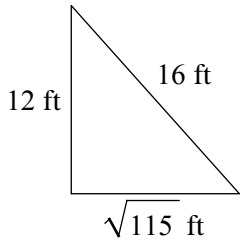

Acute

371)

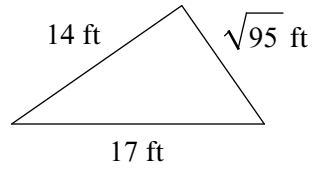

Acute

372)

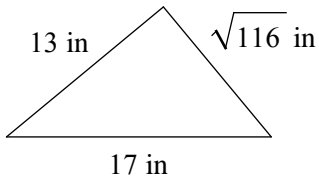

Obtuse

373)

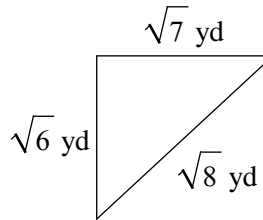

Acute

374)

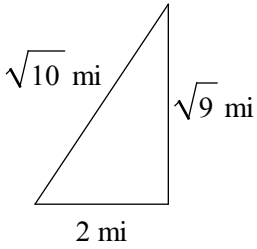

Acute

375)

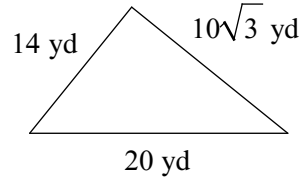

Acute

376)

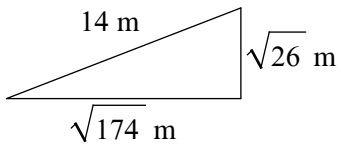

Acute

377)

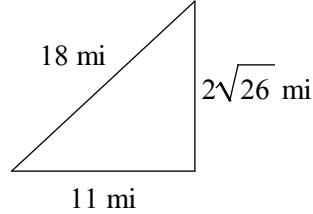

Obtuse

378)

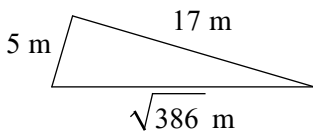

Obtuse

379)

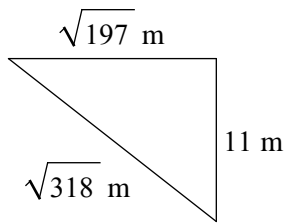

Acute

380)

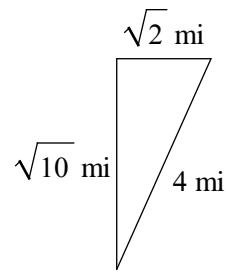

Obtuse

381)

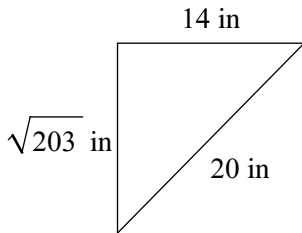

Obtuse

382)

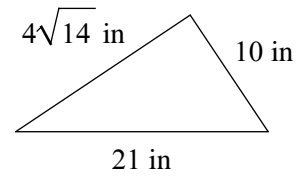

Obtuse

383)

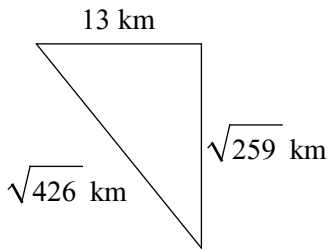

Acute

384)

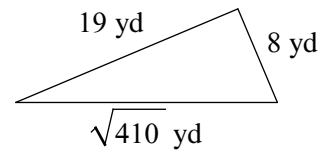

Acute

385)

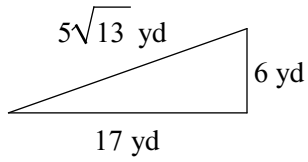

Right

386)

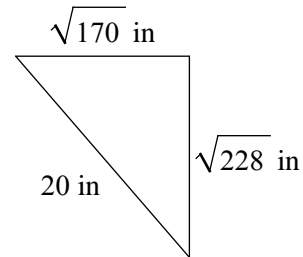

Obtuse

387)

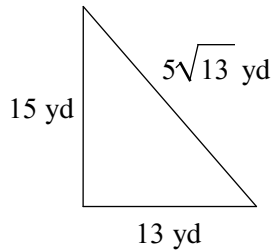

Acute

388)

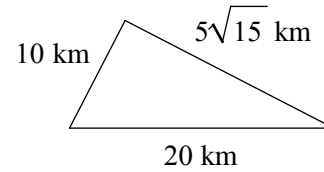

Acute



389)

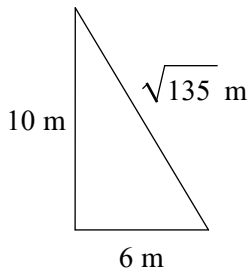

Acute

390)

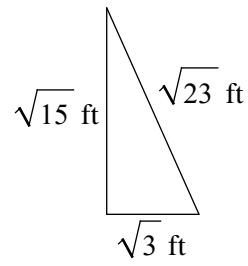

Obtuse

391)

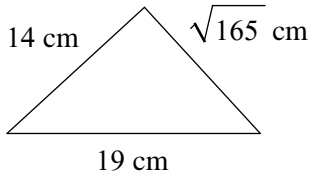

Right

392)

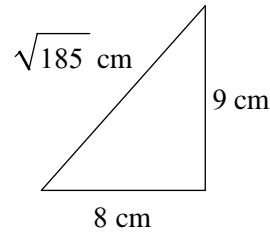

Obtuse

393)

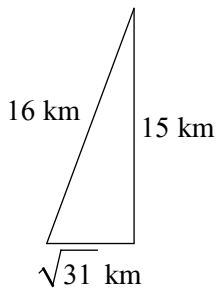

Right

394)

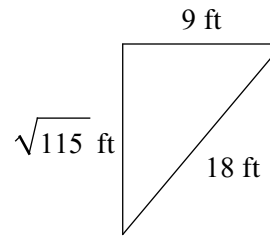

Obtuse

395)

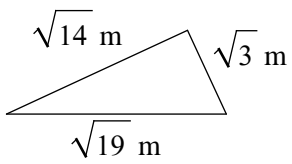

Obtuse

396)

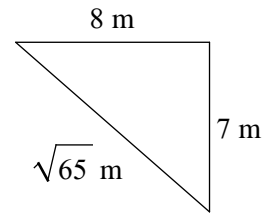

Acute

397)

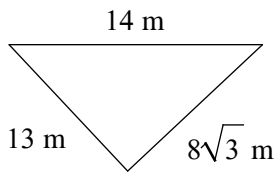

Acute

398)

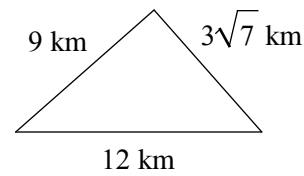

Right

399)

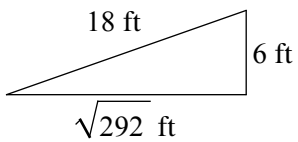

Acute

400)

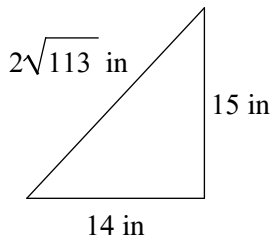

Obtuse

401)

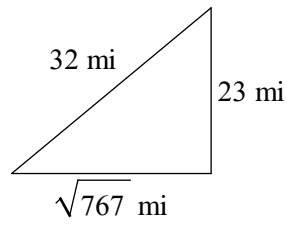

Acute

402)

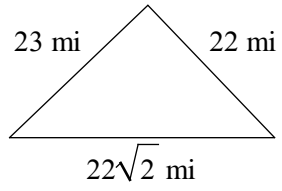

Acute

403)

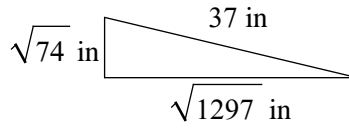

Acute

404)

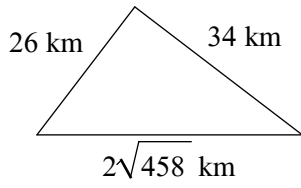

Acute

405)

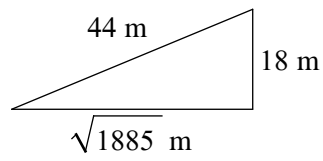

Acute

406)

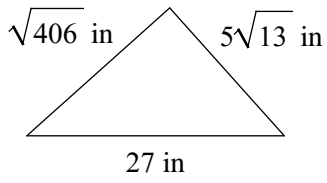

Acute

407)

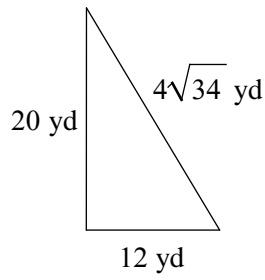

Right

408)

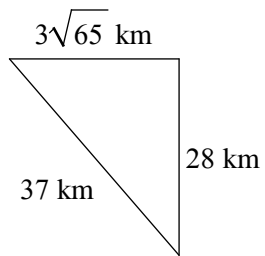

Right

409)

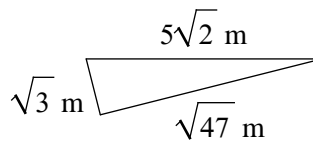

Obtuse

410)

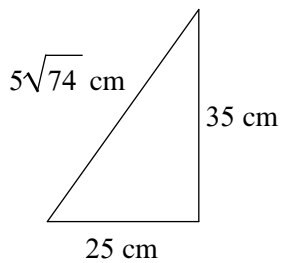

Obtuse

411)

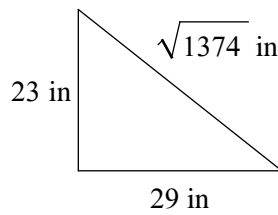

Obtuse

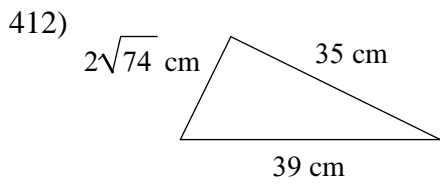

Right

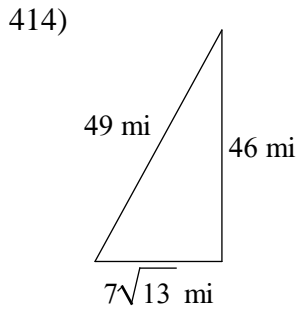

Acute

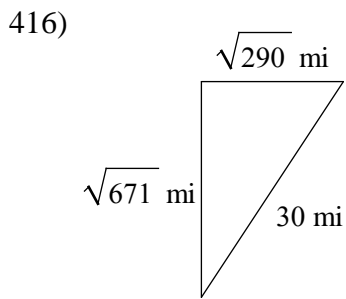

Acute

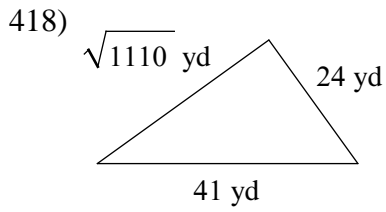

Acute

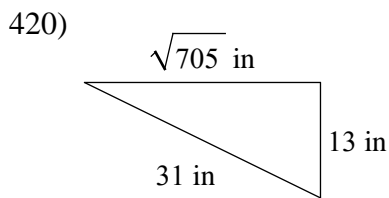

Obtuse

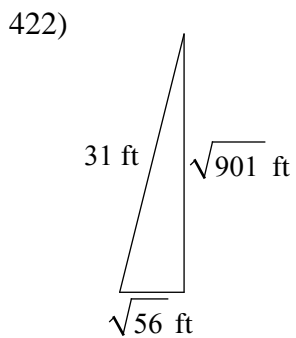

Obtuse

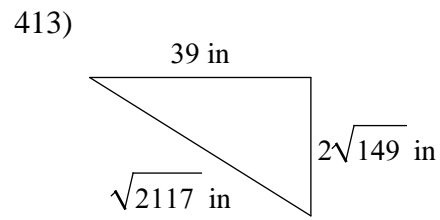

Right

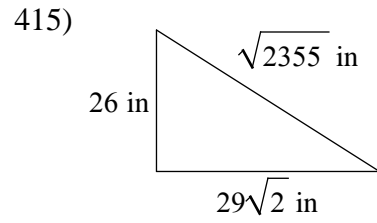

Acute

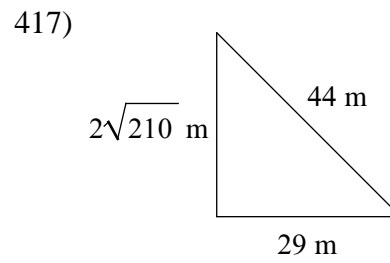

Obtuse

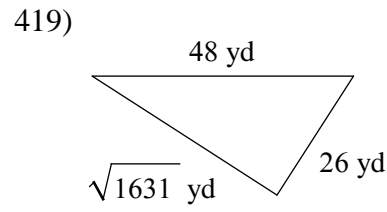

Acute

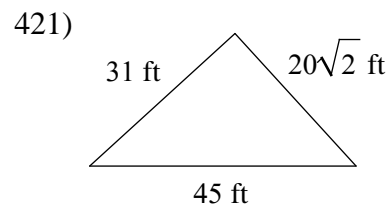

Obtuse

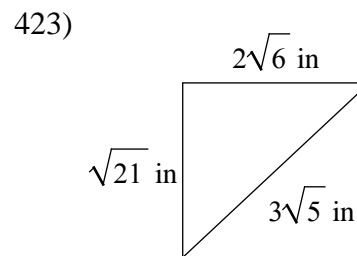

Obtuse

424)

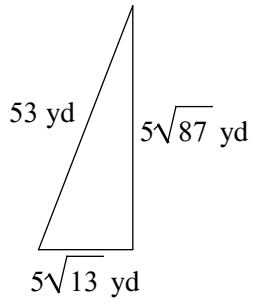

Obtuse

425)

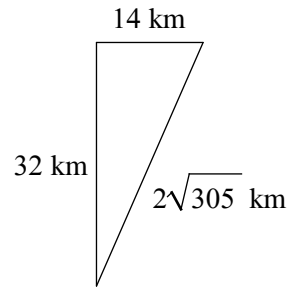

Acute

426)

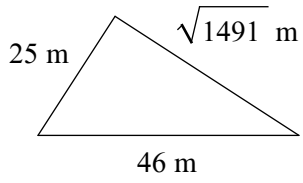

Right

427)

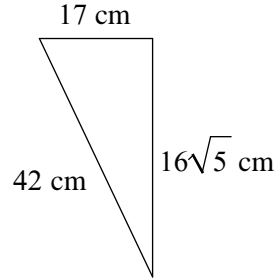

Obtuse

428)

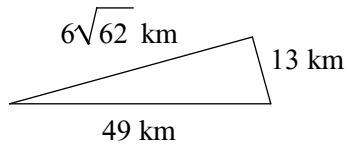

Acute

429)

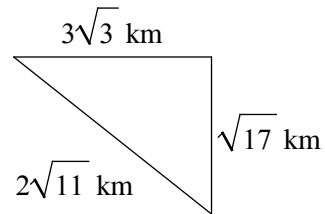

Right

430)

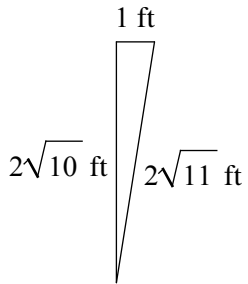

Obtuse

431)

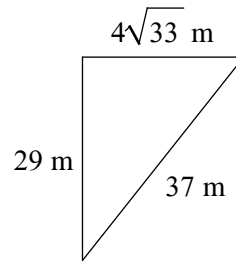

Right

432)

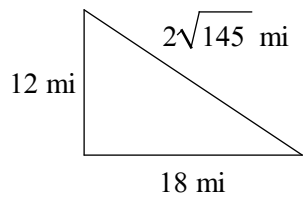

Obtuse

433)

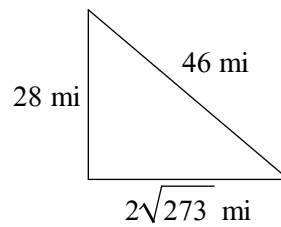

Obtuse

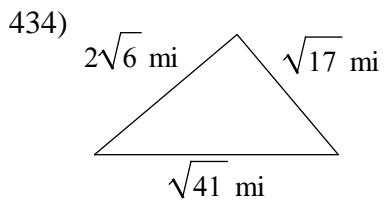

Right

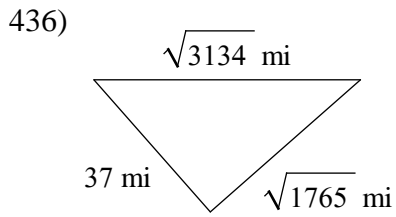

Right

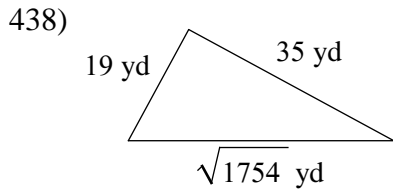

Obtuse

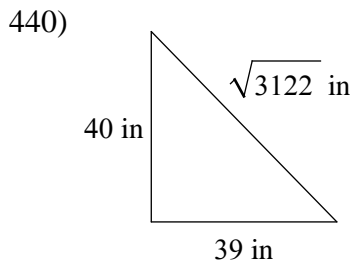

Obtuse

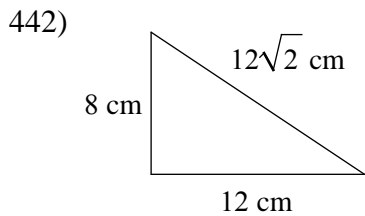

Obtuse

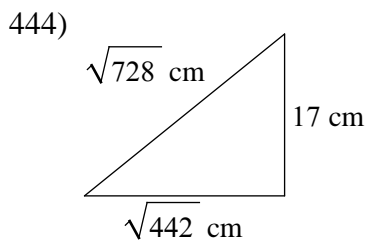

Acute

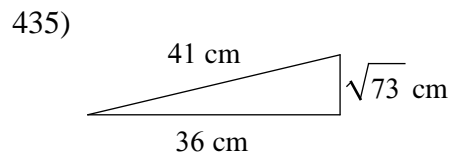

Obtuse

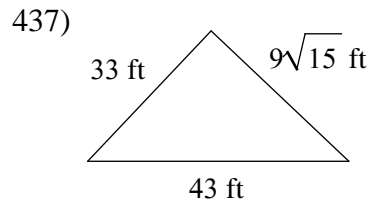

Acute

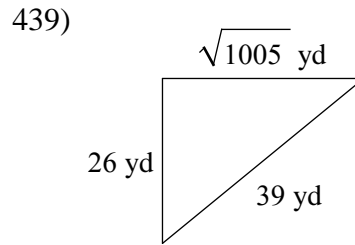

Acute

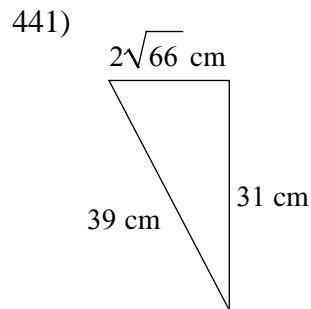

Obtuse

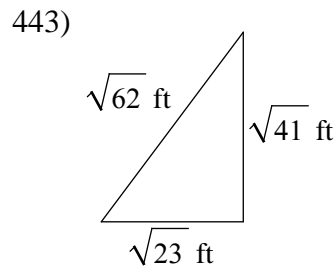

Acute

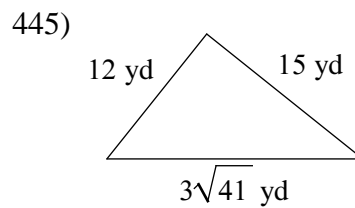

Right

446)

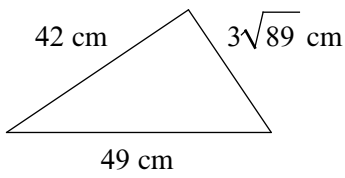

Acute

447)

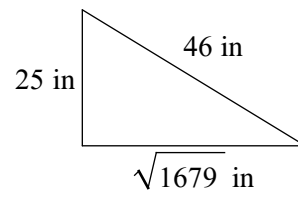

Acute

448)

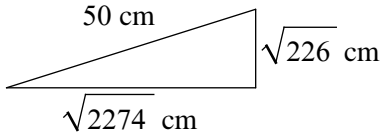

Right

449)

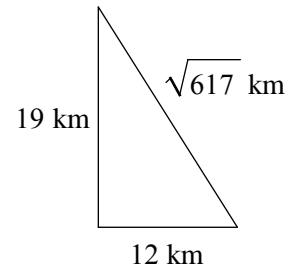

Obtuse

450)

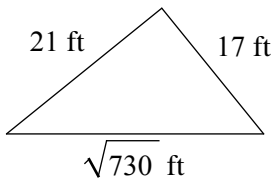

Right

451)

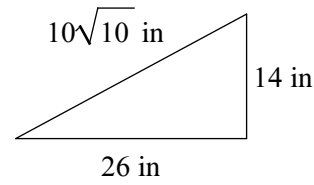

Obtuse

452)

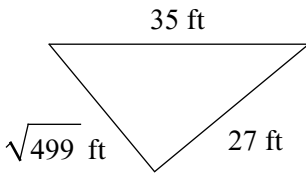

Acute

453)

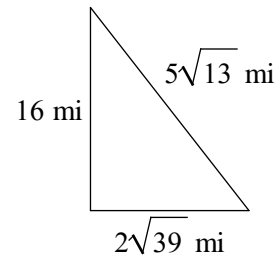

Acute

454)

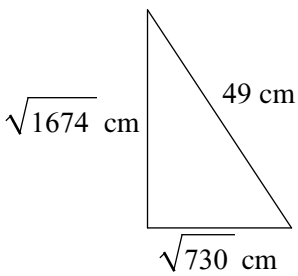

Acute

455)

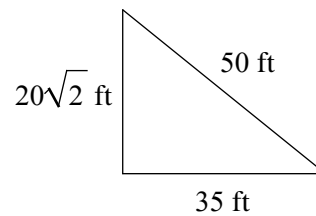

Obtuse

456)

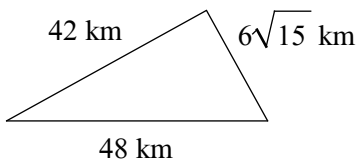

Right

457)

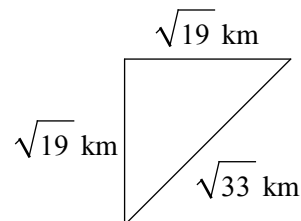

Acute

458)

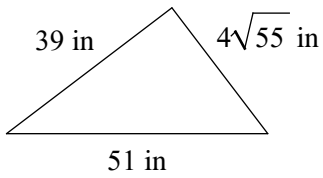

Obtuse

460)

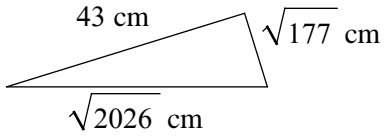

Obtuse

462)

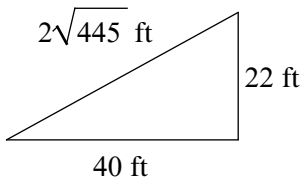

Acute

464)

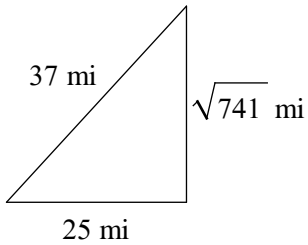

Obtuse

466)

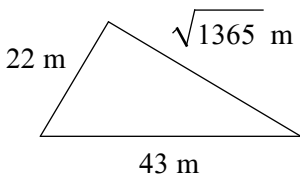

Acute

468)

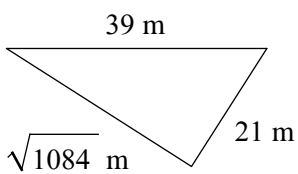

Acute

459)

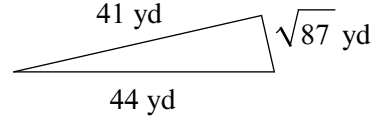

Obtuse

461)

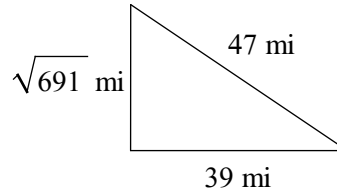

Acute

463)

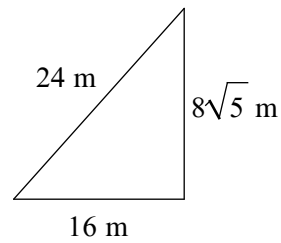

Right

465)

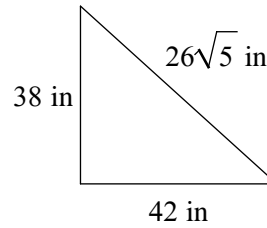

Obtuse

467)

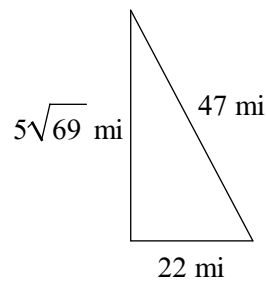

Right

469)

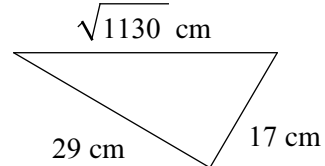

Acute

470)

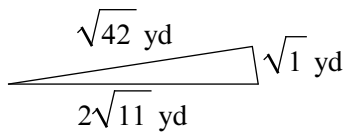

Obtuse

471)

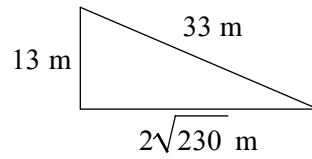

Right

472)

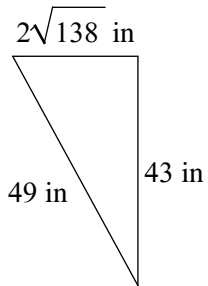

Right

473)

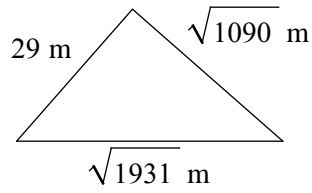

Acute

474)

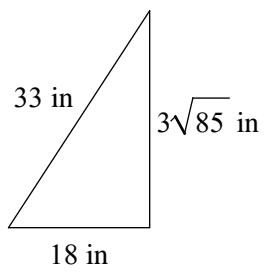

Right

475)

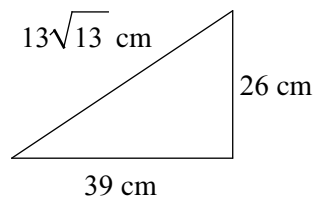

Acute

476)

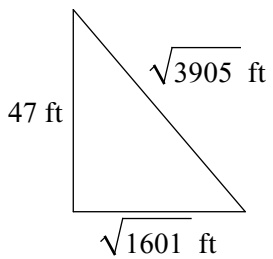

Obtuse

477)

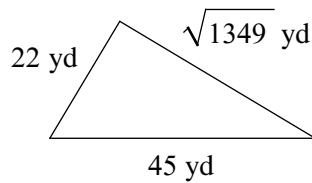

Obtuse

478)

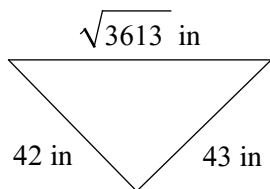

Right

479)

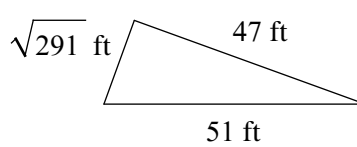

Obtuse

480)

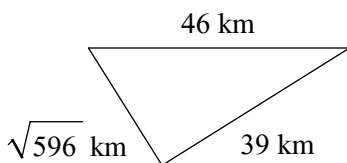

Acute

481)

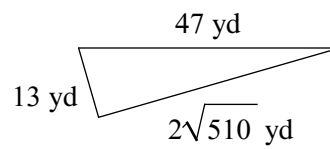

Right



482)

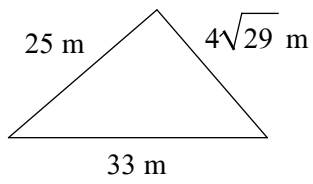

Right

483)

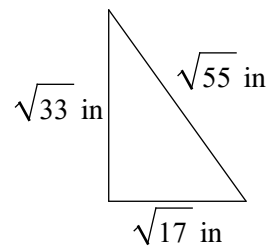

Obtuse

484)

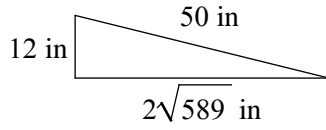

Right

485)

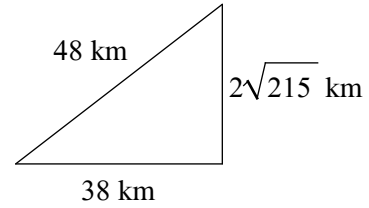

Right

486)

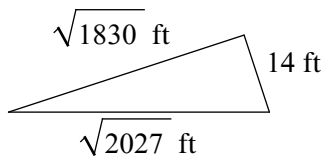

Obtuse

487)

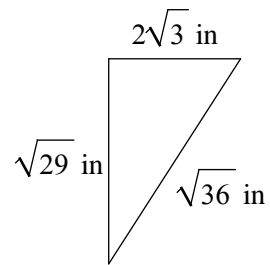

Acute

488)

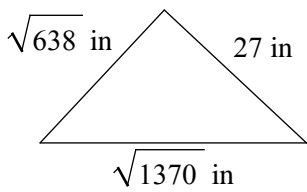

Obtuse

489)

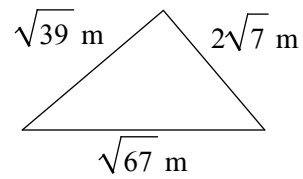

Right

490)

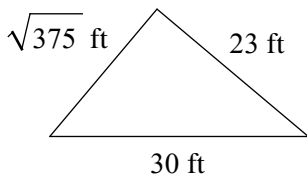

Acute

491)

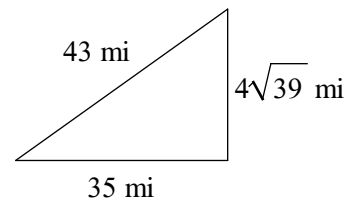

Right

492)

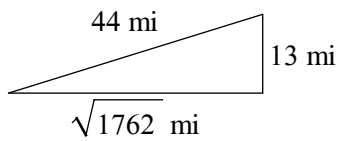

Obtuse

493)

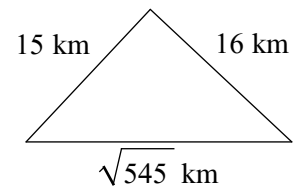

Obtuse

494)

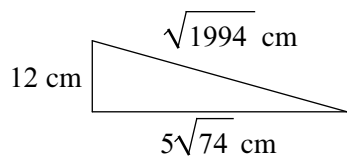

Right

495)

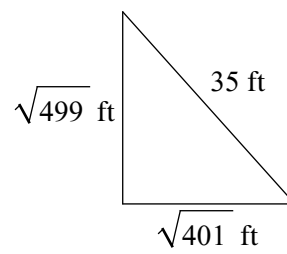

Obtuse

496)

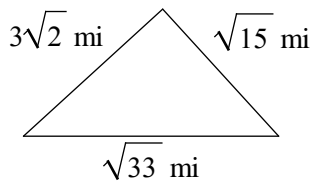

Acute

497)

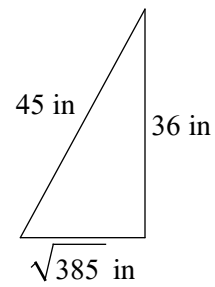

Obtuse

498)

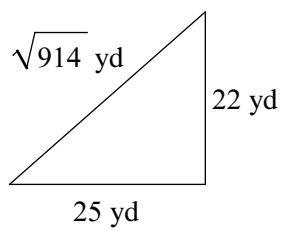

Acute

499)

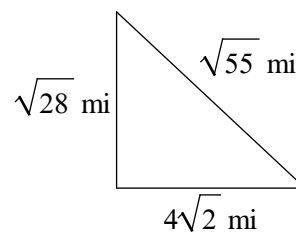

Acute

500)

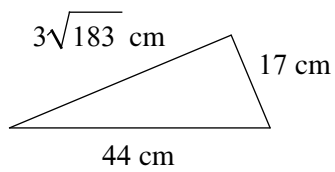

Acute