

Surface area of solid figures

Find the surface area of triangular prisms and pyramids, square prism and pyramids, rectangular prism and pyramids:

1)

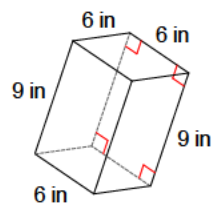

2)

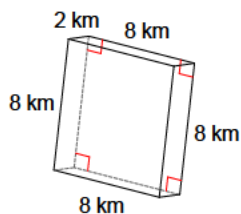

3)

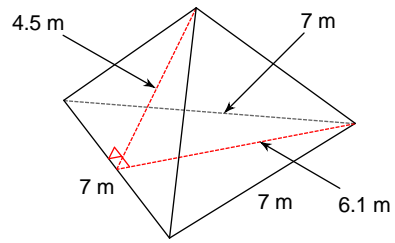

4)

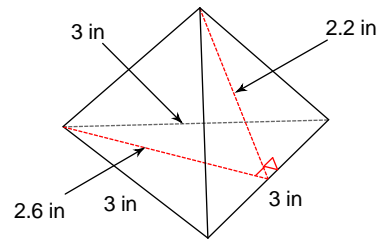

5)

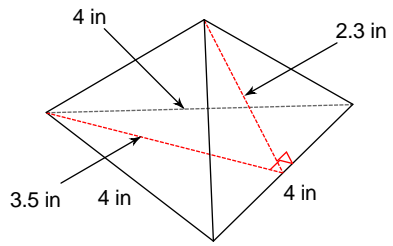

6)

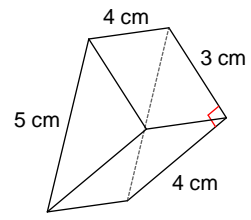

7)

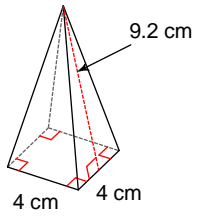

8)

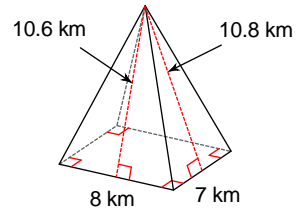

9)

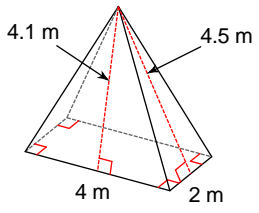

10)

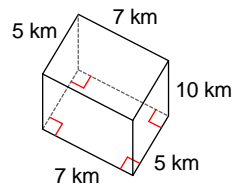

11)

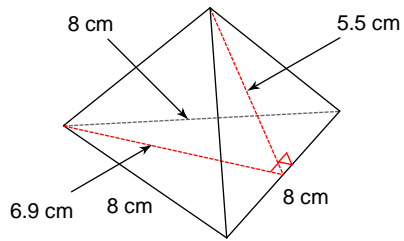

12)

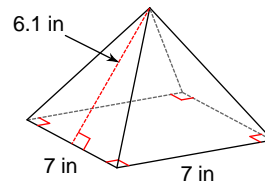

13)

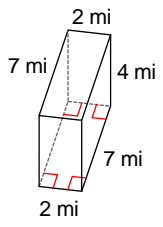

14)

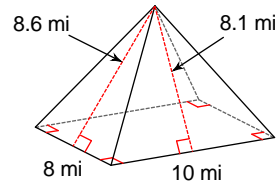

15)

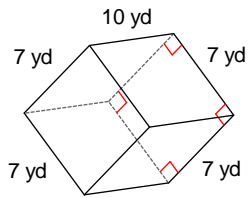

16)

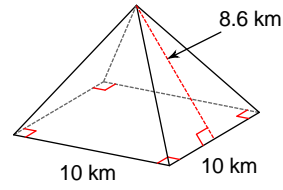

17)

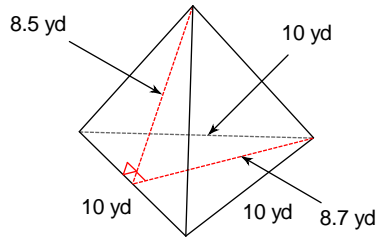

18)

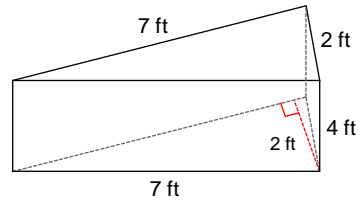

19)

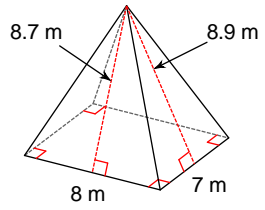

20)

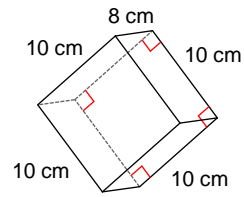

21)

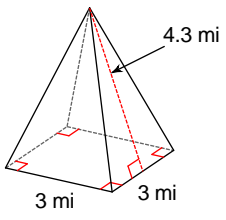

22)

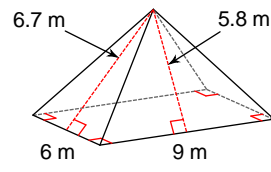

23)

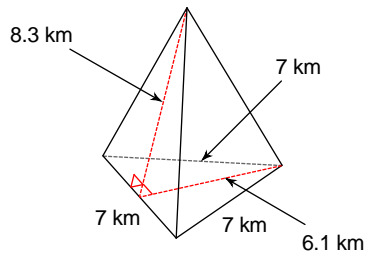

24)

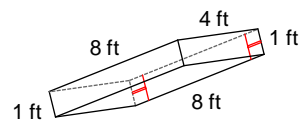

25)

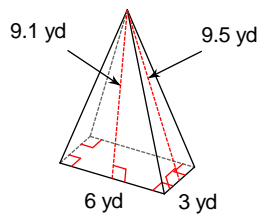

26)

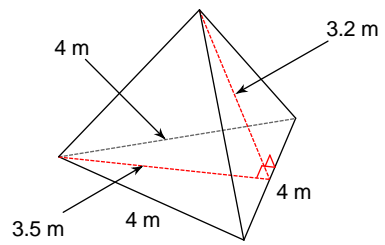

27)

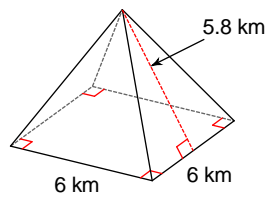

28)

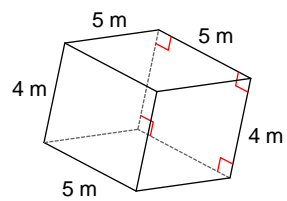

29)

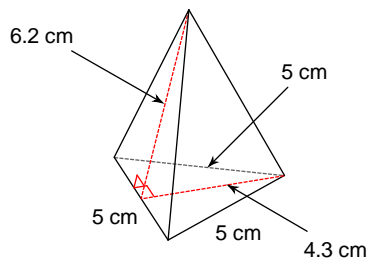

30)

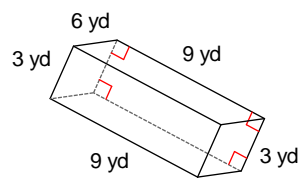

31)

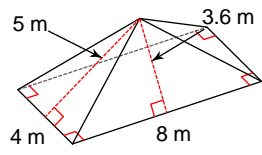

32)

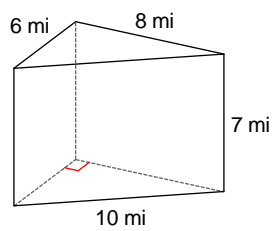

33)

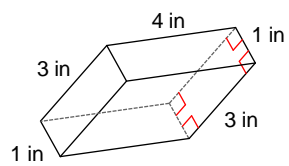

34)

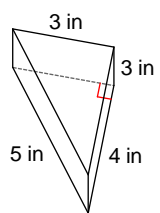

35)

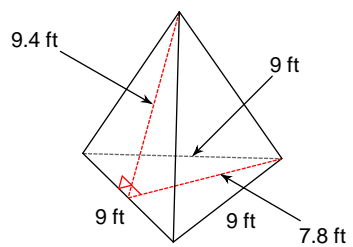

36)

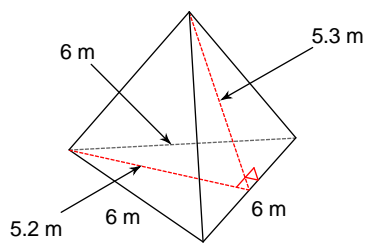

37)

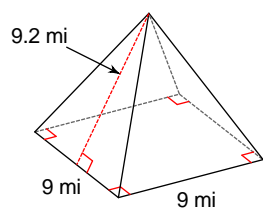

38)

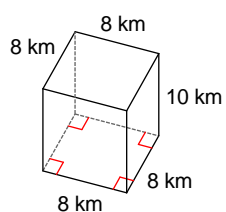

39)

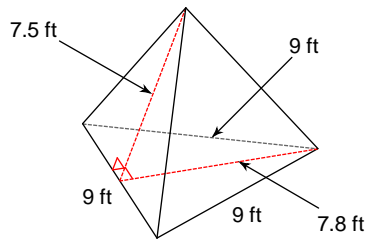

40)

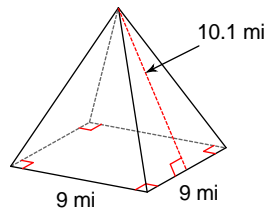

41)

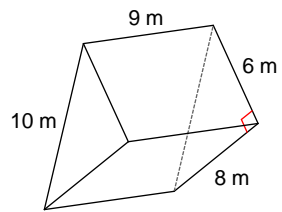

42)

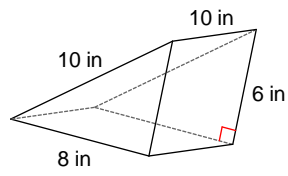

43)

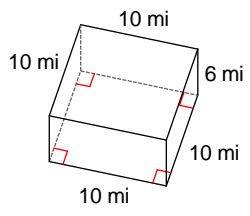

44)

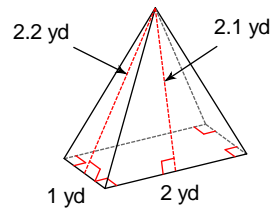

45)

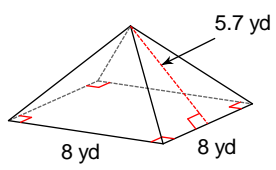

46)

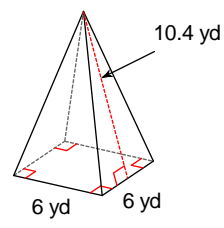

47)

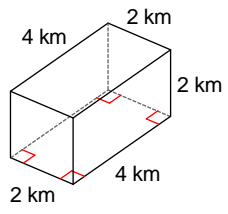

48)

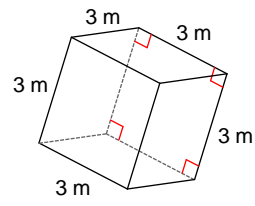

49)

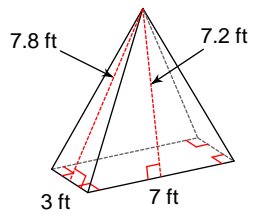

50)

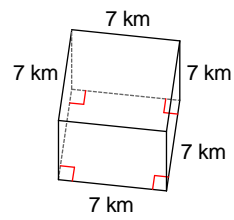

51)

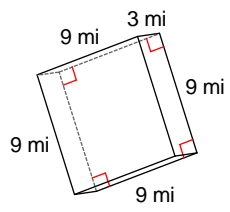

52)

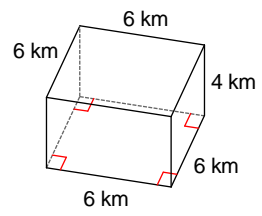

53)

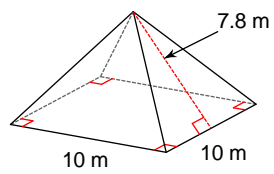

54)

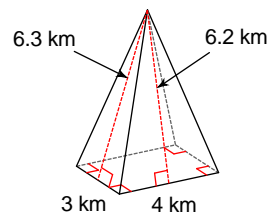

55)

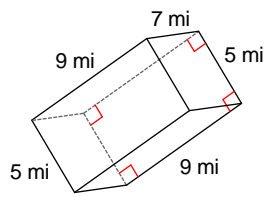

56)

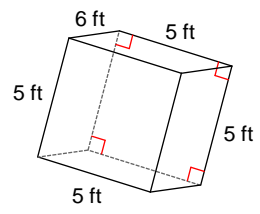

57)

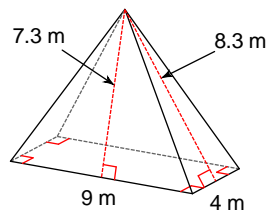

58)

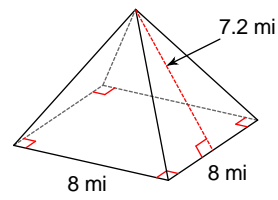

59)

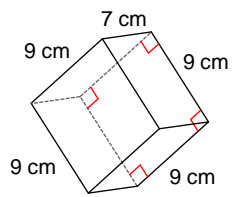

60)

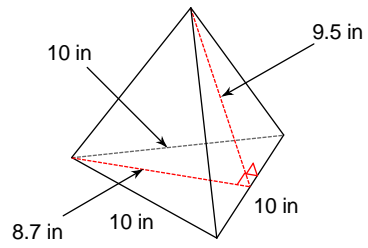

61)

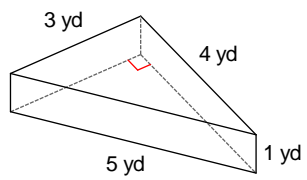

62)

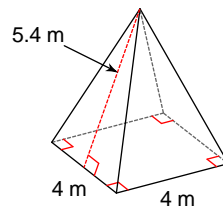

63)

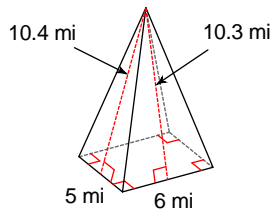

64)

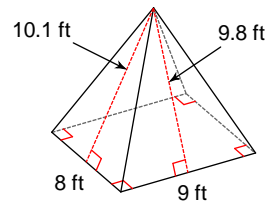

65)

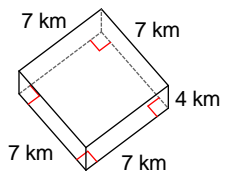

66)

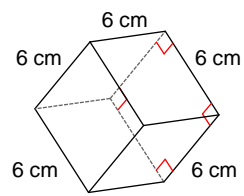

67)

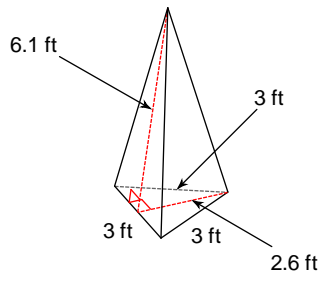

68)

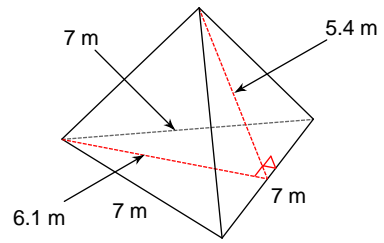

69)

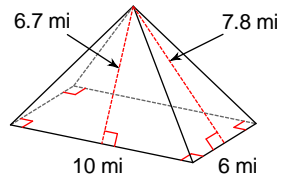

70)

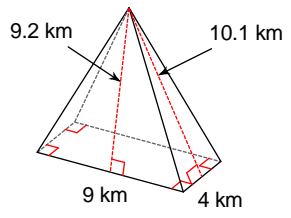

71)

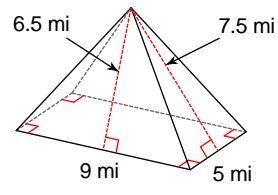

72)

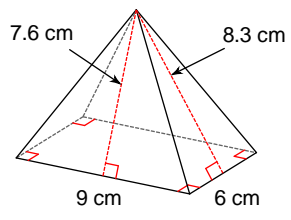

73)

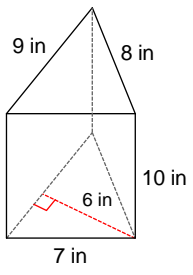

74)

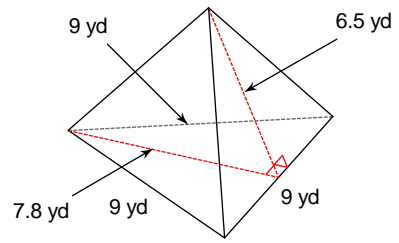

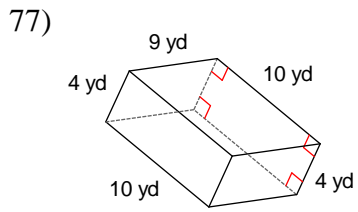
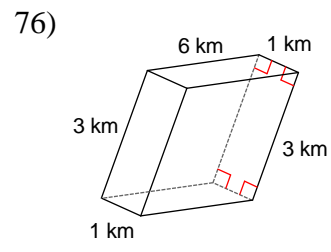
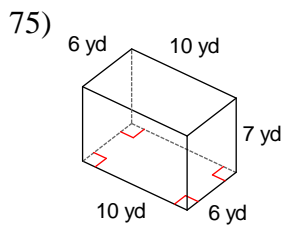

78)

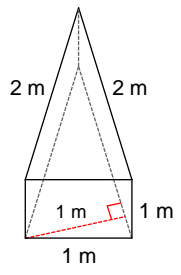

79)

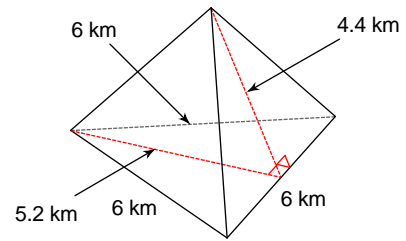

80)

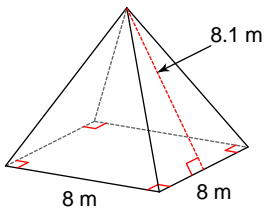

81)

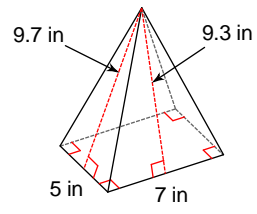

82)

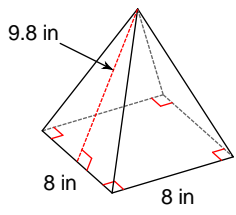

83)

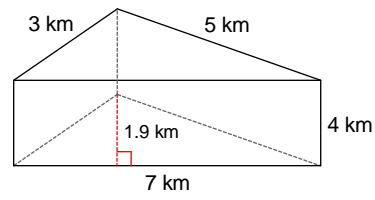

84)

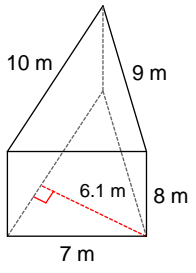

85)

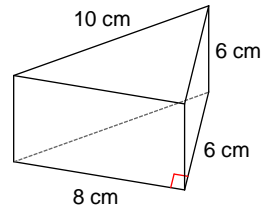

86)

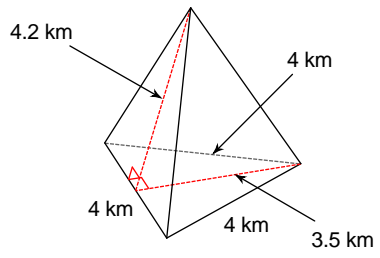

87)

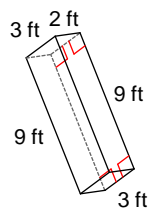

88)

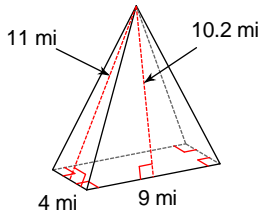

89)

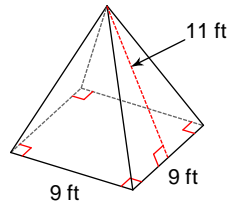

90)

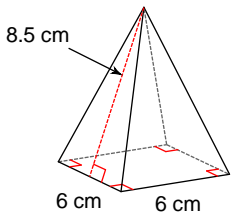

91)

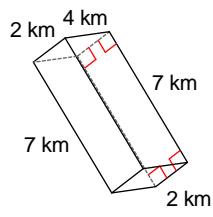

92)

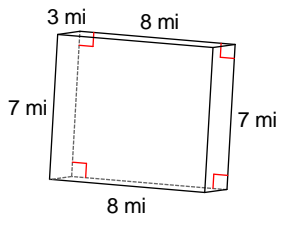

93)

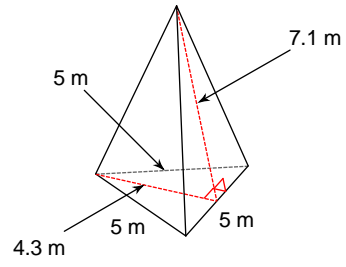

94)

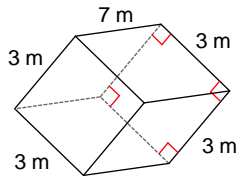

95)

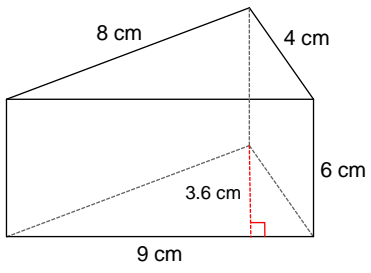

96)

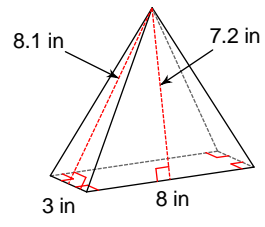

97)

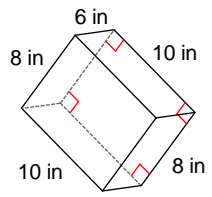

98)

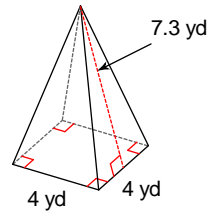

99)

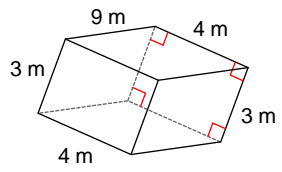

100)

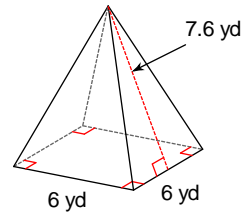

Find the surface area of trapezoidal prisms, pentagonal prisms and pyramids, hexagonal prisms and pyramids:

101)

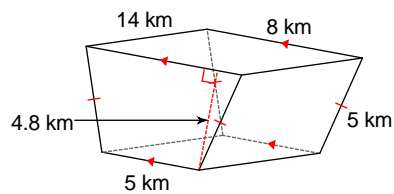

102)

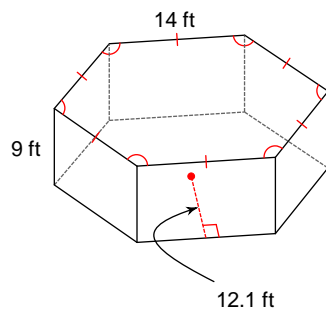

103)

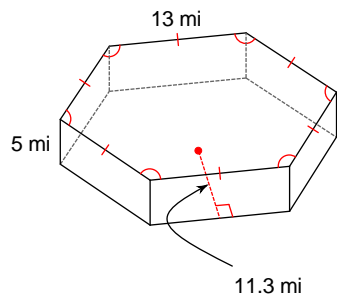

104)

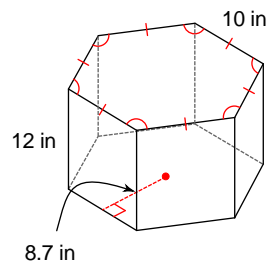

105)

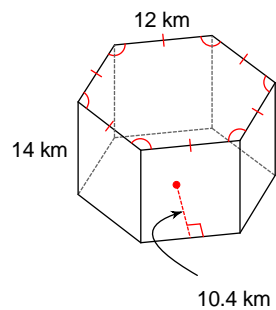

106)

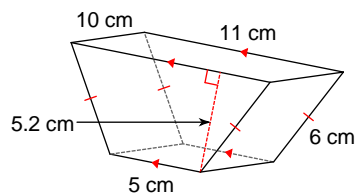

107)

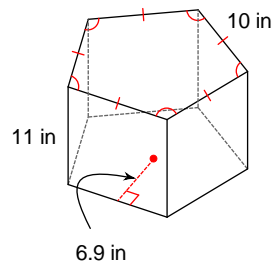

108)

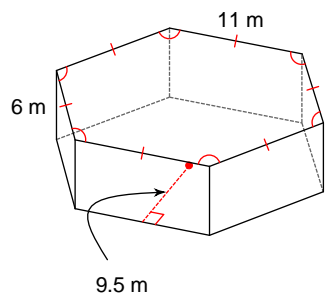

109)

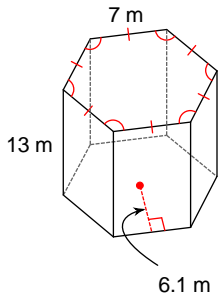

110)

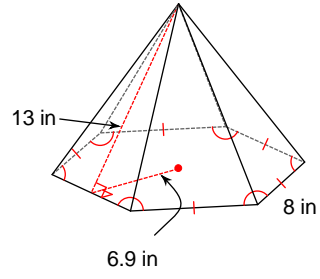

111)

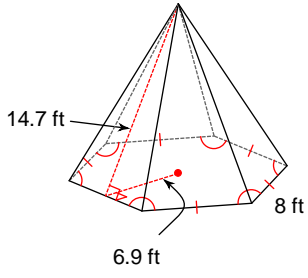

112)

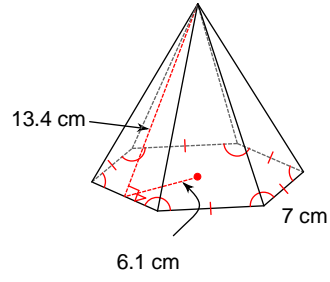

113)

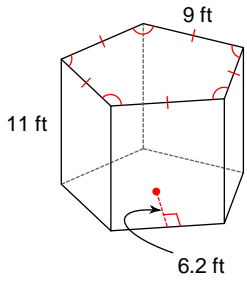

114)

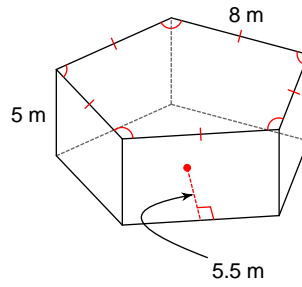

115)

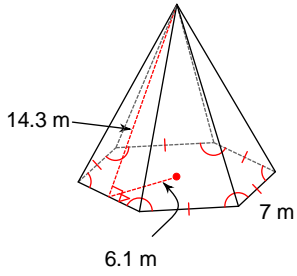

116)

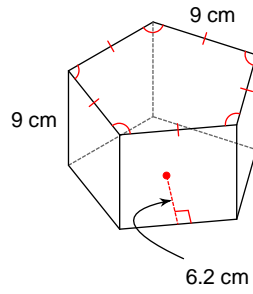

117)

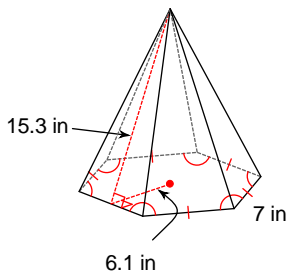

118)

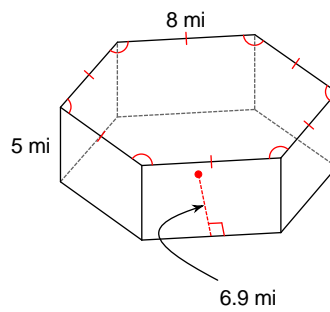

119)

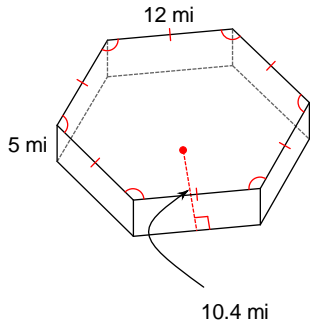

120)

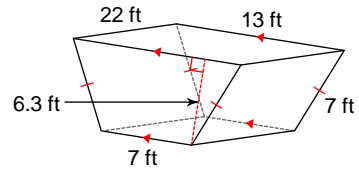

121)

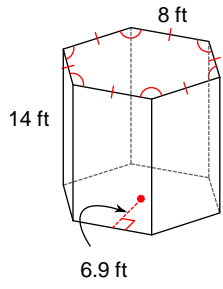

122)

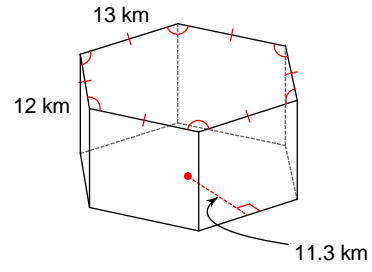

123)

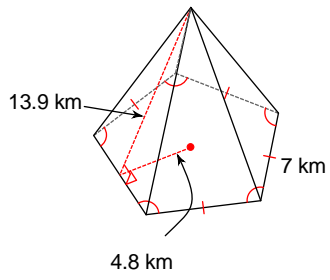

124)

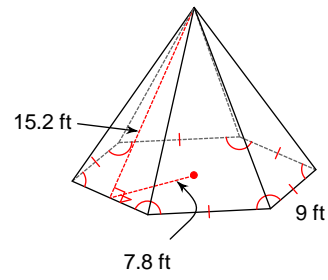

125)

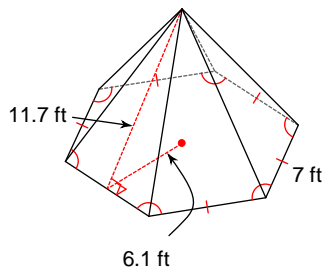

126)

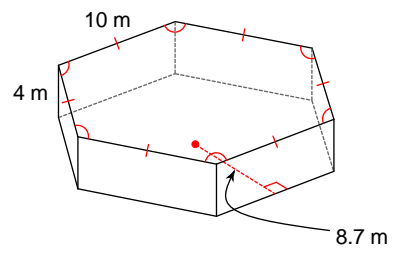

127)

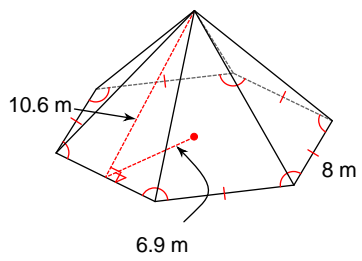

128)

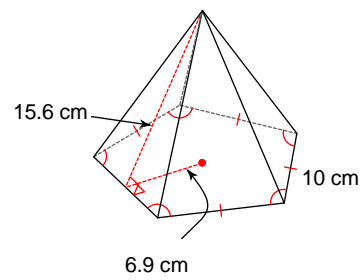

129)

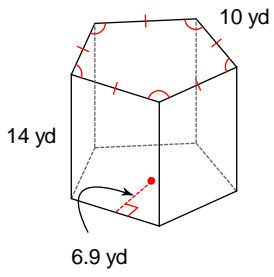

130)

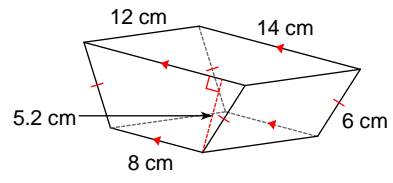

131)

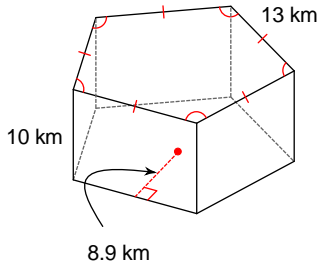

132)

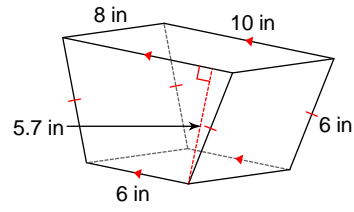

133)

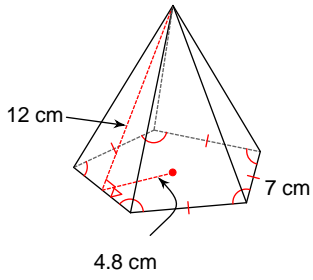

134)

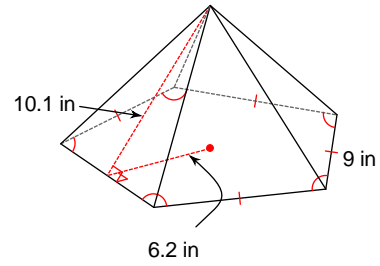

135)

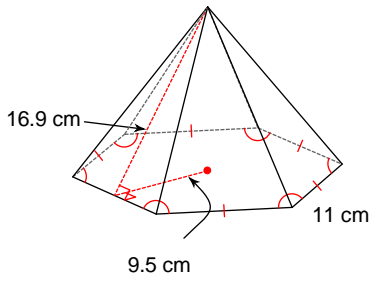

136)

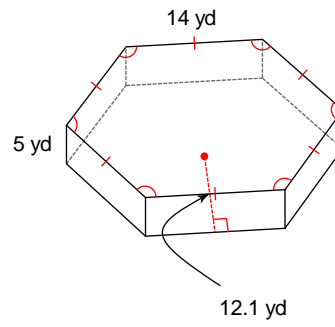

137)

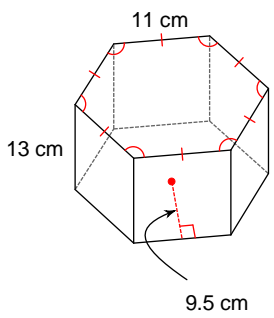

138)

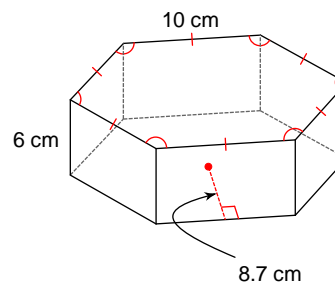

139)

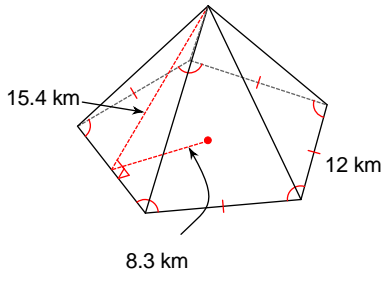

140)

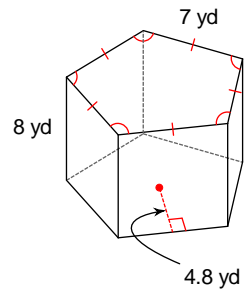

141)

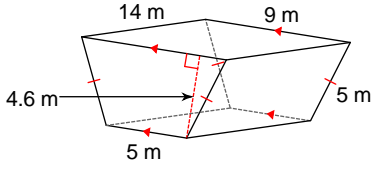

142)

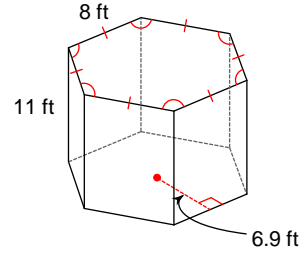

143)

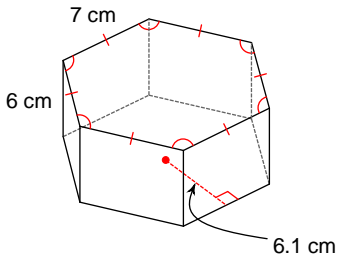

144)

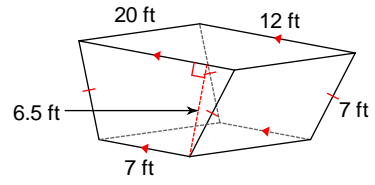

145)

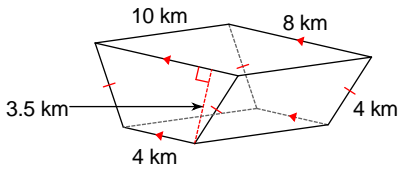

146)

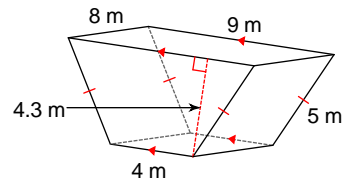

147)

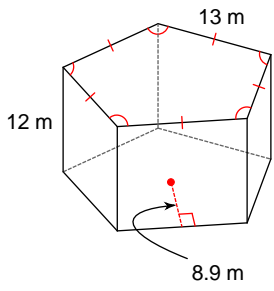

148)

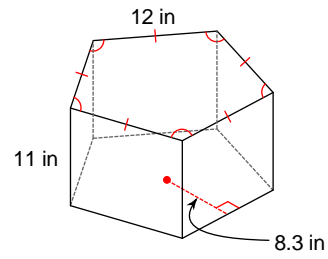

149)

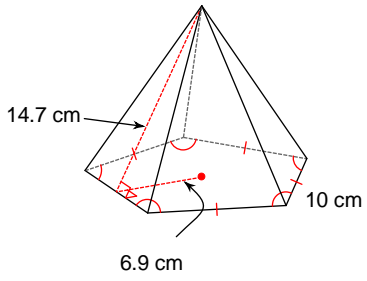

150)

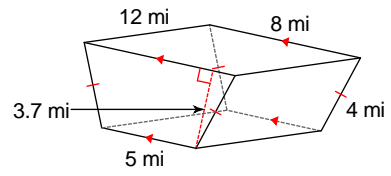

151)

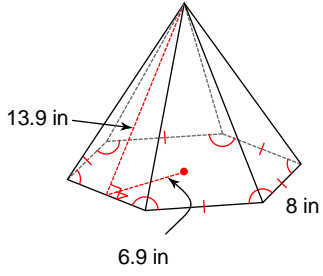

152)

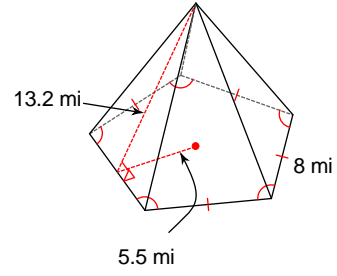

153)

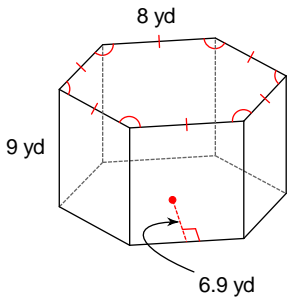

154)

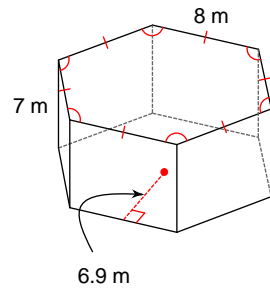

155)

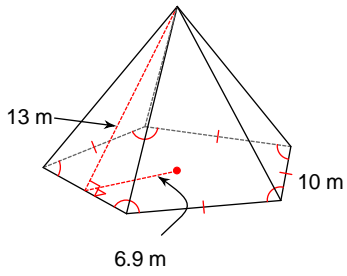

156)

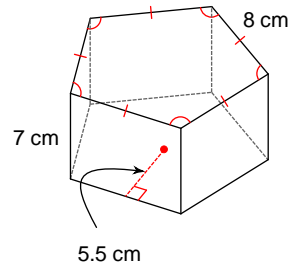

157)

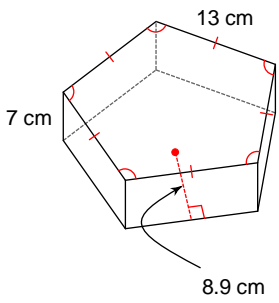

158)

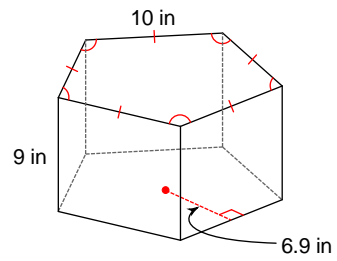

159)

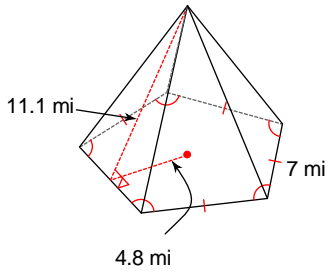

160)

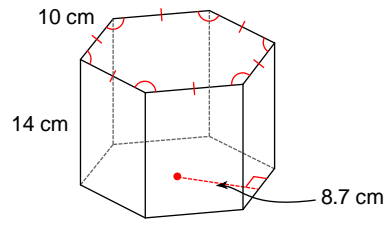

161)

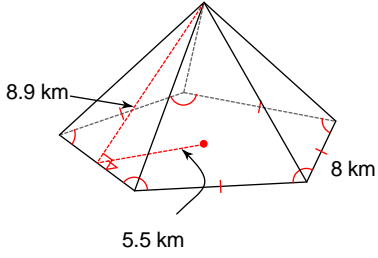

162)

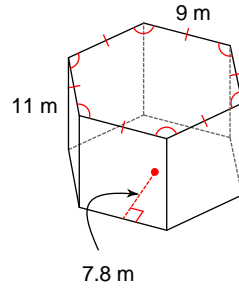

163)

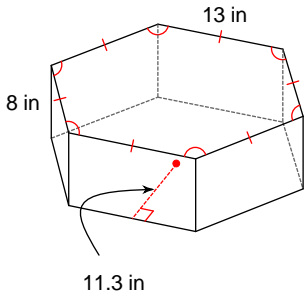

164)

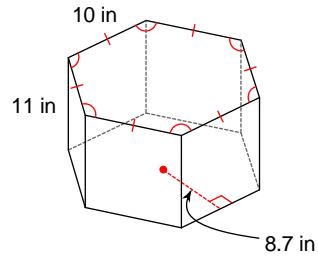

165)

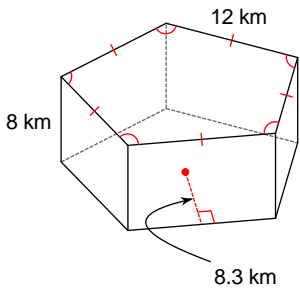

166)

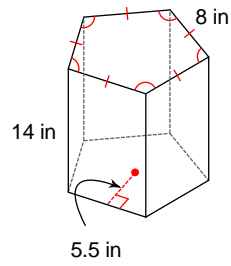

167)

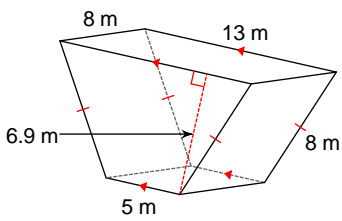

168)

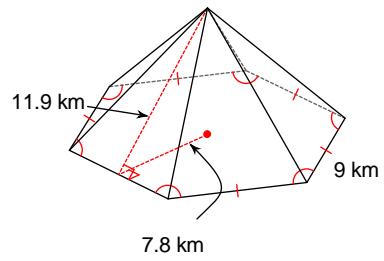

169)

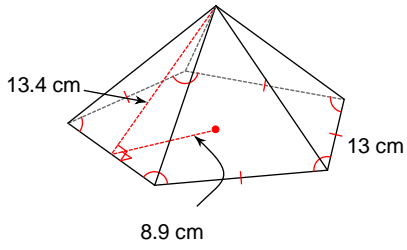

170)

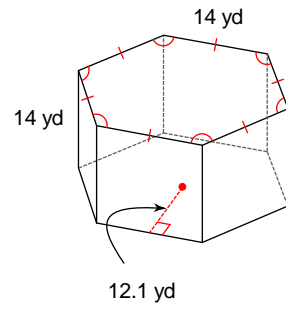

171)

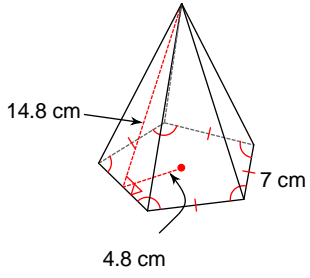

172)

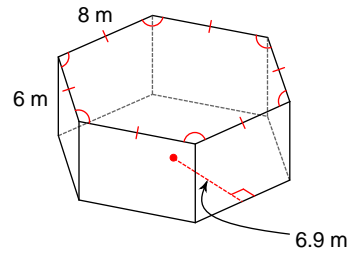

173)

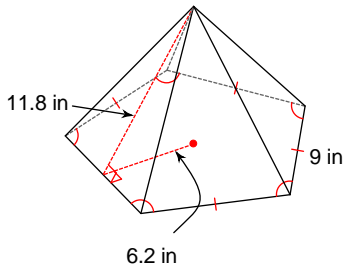

174)

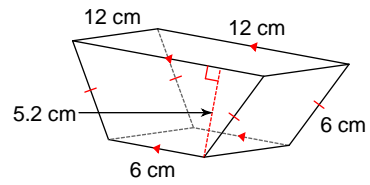

175)

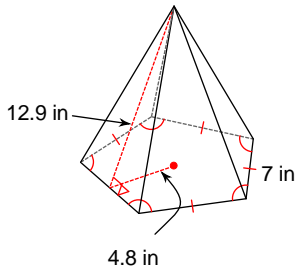

176)

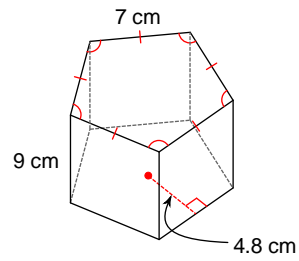

177)

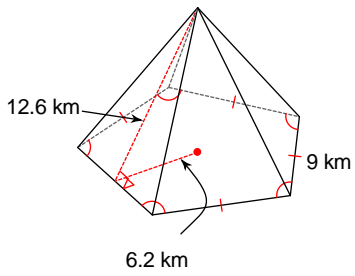

178)

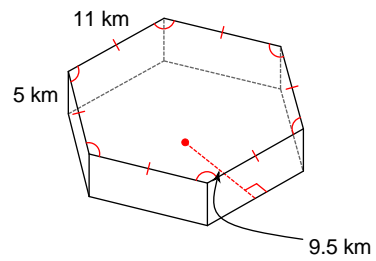

179)

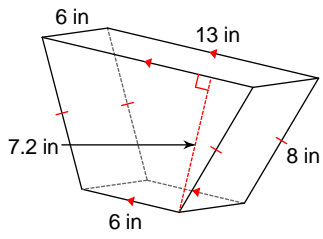

180)

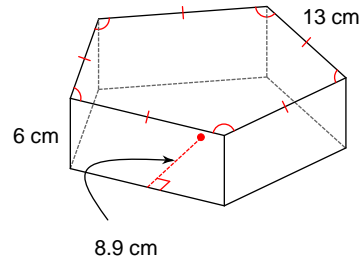

181)

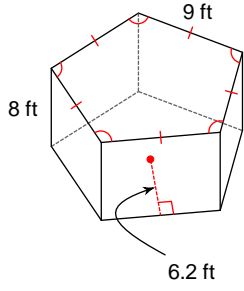

182)

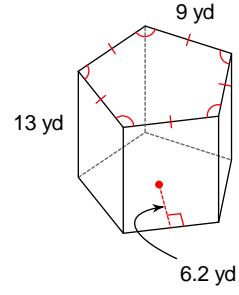

183)

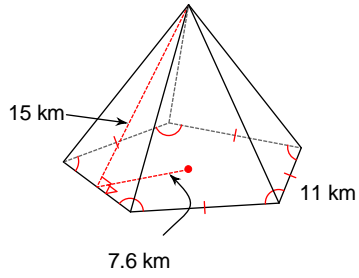

184)

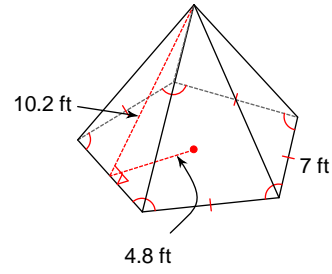

185)

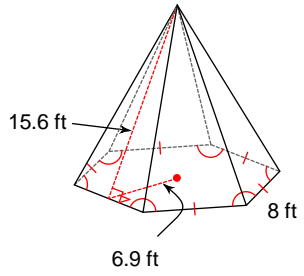

186)

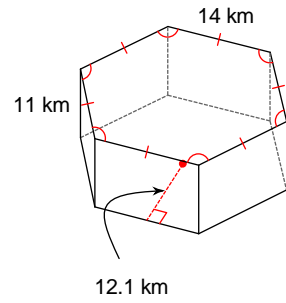

187)

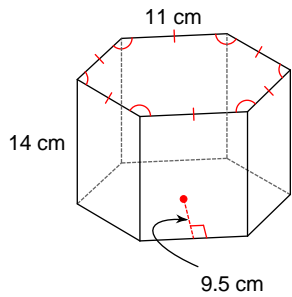

188)

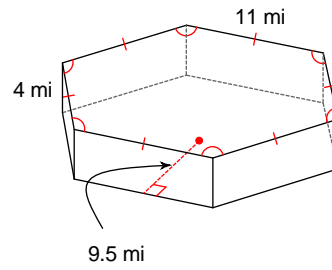

189)

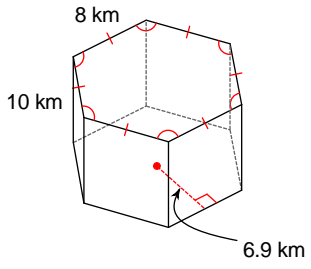

190)

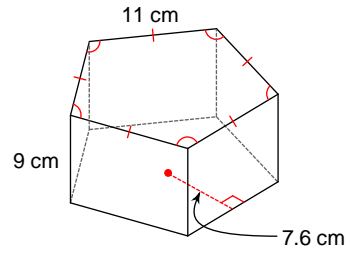

191)

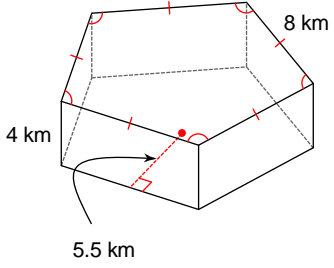

192)

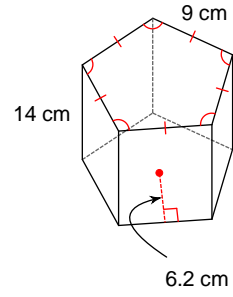

193)

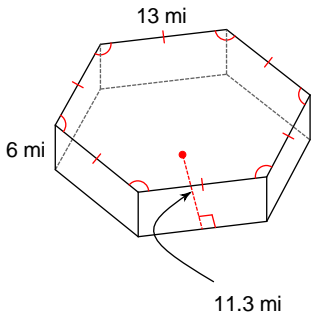

194)

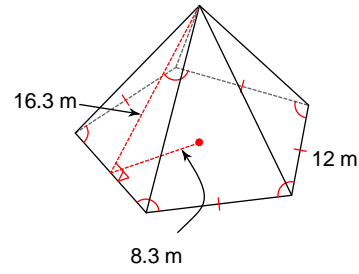

195)

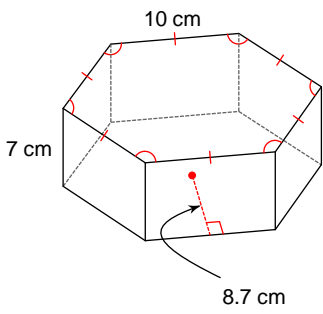

196)

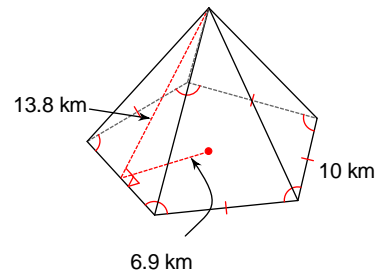

197)

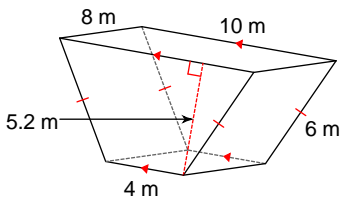

198)

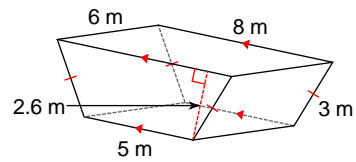

199)

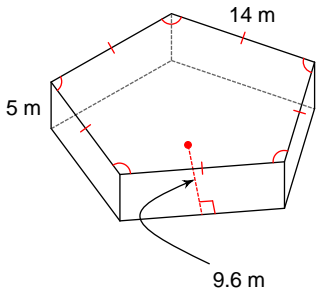

200)

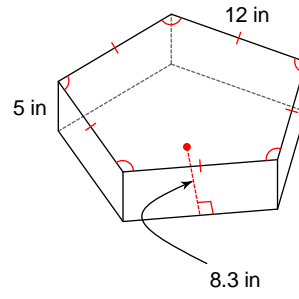

Find the surface area of cylinders, cones and spheres:

201)

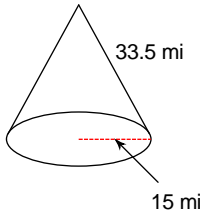

202)

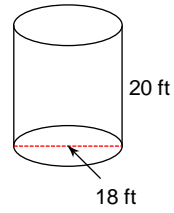

203)

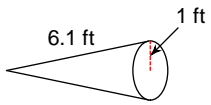

204)

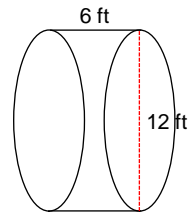

205)

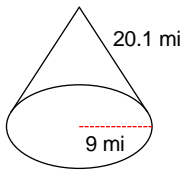

206)

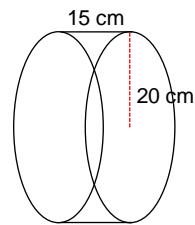

207)

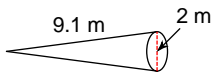

208)

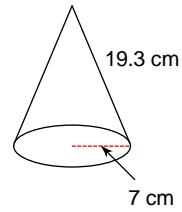

209)

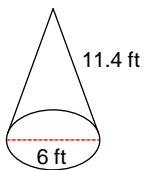

210)

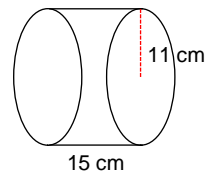

211)

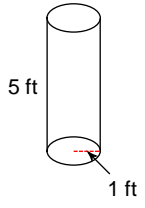

212)

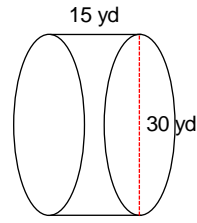

213)

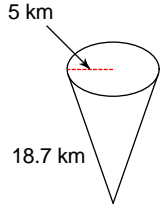

214)

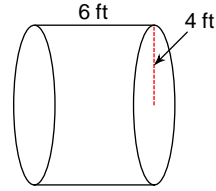

215)

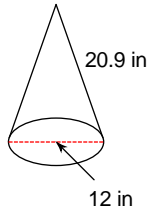

216)

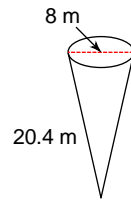

217)

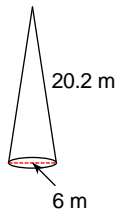

218)

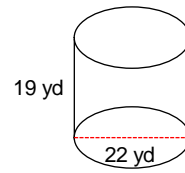

219)

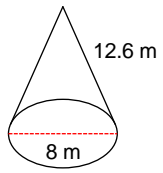

220)

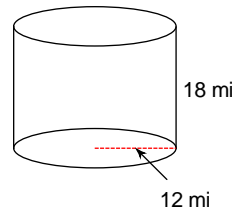

221)

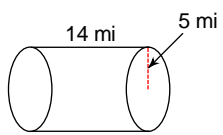

222)

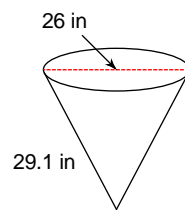

223)

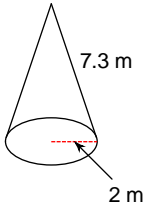

224)

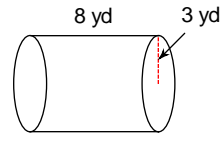

225)

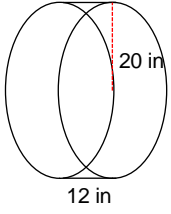

226)

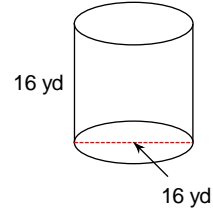

227)

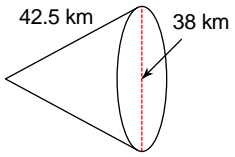

228)

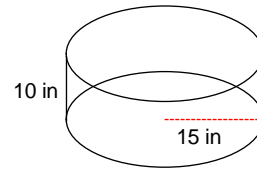

229)

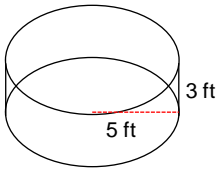

230)

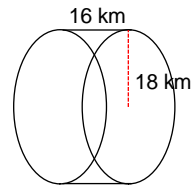

231)

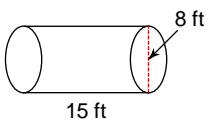

232)

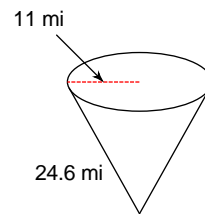

233)

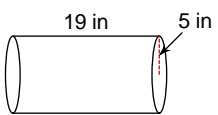

234)

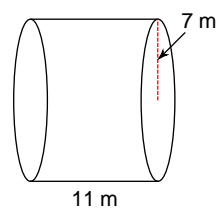

235)

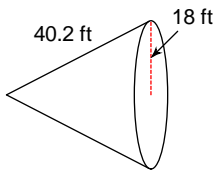

236)

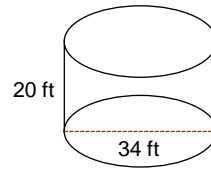

237)

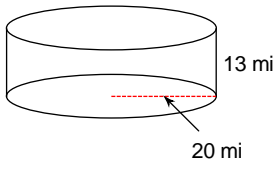

238)

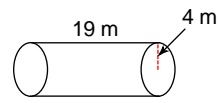

239)

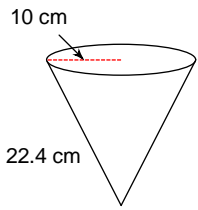

240)

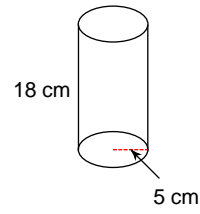

241)

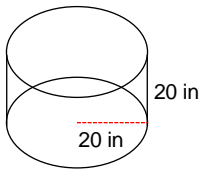

242)

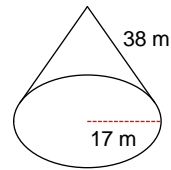

243)

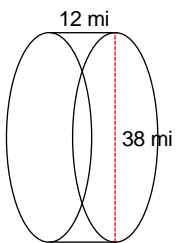

244)

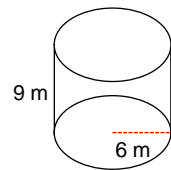

245)

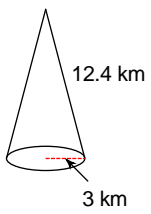

246)

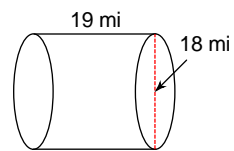

247)

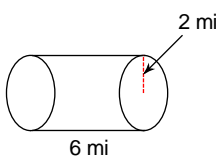

248)

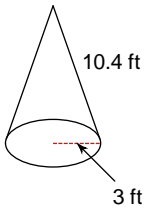

249)

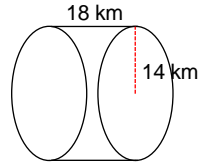

250)

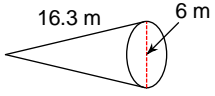

251)

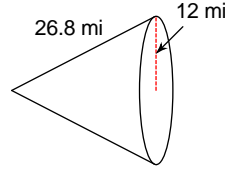

252)

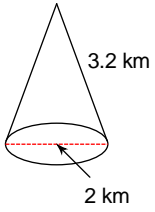

253)

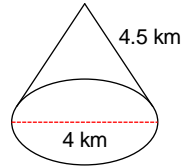

254)

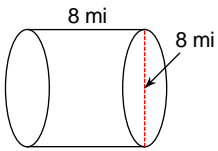

255)

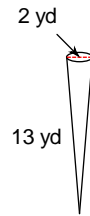

256)

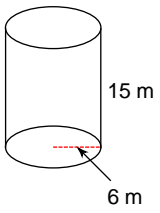

257)

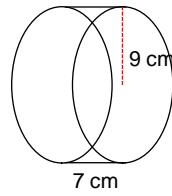

258)

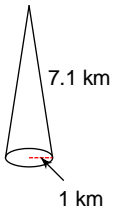

259)

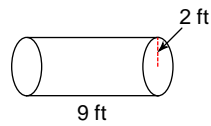

260)

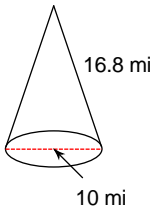

261)

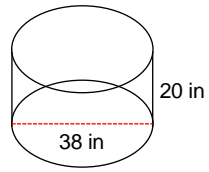

262)

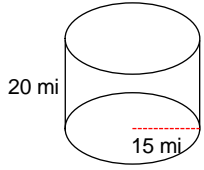

263)

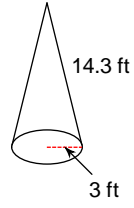

264)

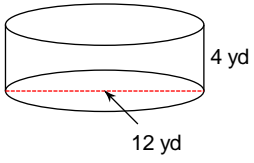

265)

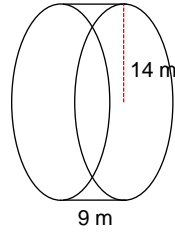

266)



267)

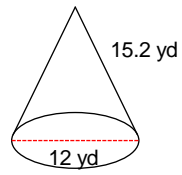

268)

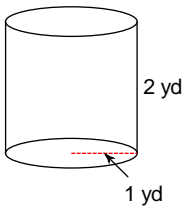

269)

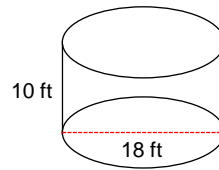

270)

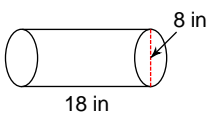

271)

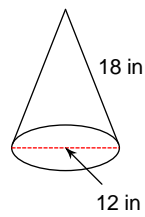

272)

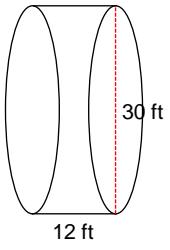

273)

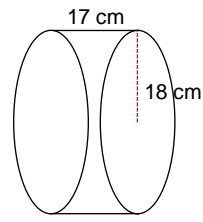

274)

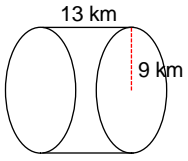

275)

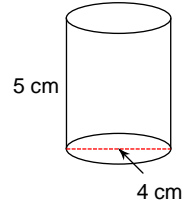

276)

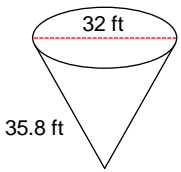

277)

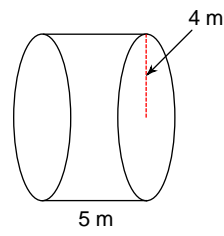

278)

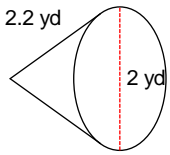

279)

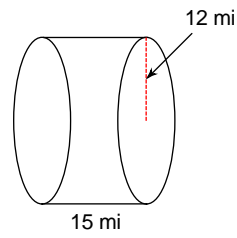

280)

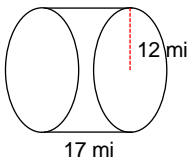

281)

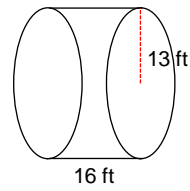

282)

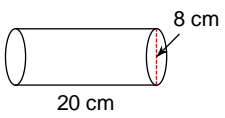

283)

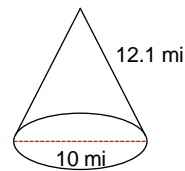

284)

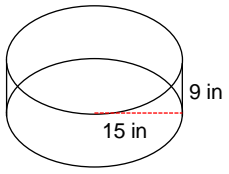

285)

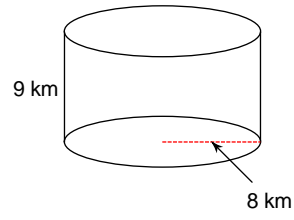

286)

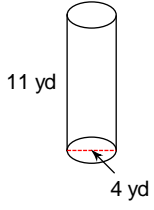

287)

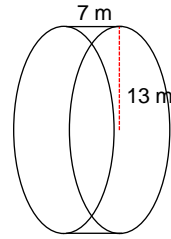

288)

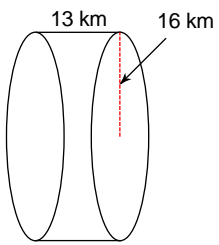

289)

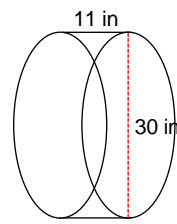

290)

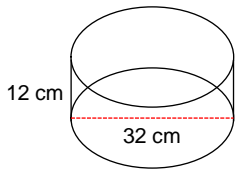

291)

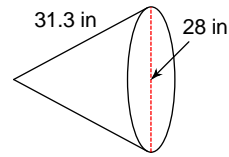

292)

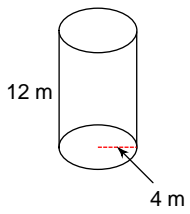

293)

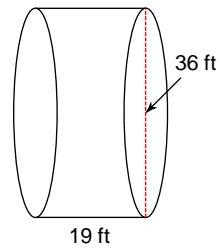

294)

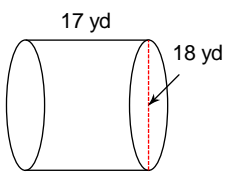

295)



296)

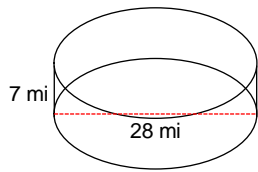

297)

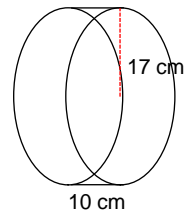

298)

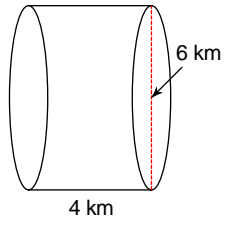

299)

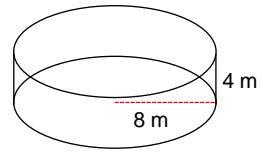

300)

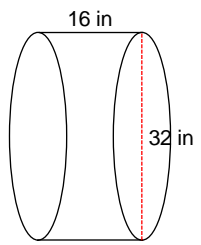

Surface area of solid figures

Find the surface area of triangular prisms and pyramids, square prism and pyramids, rectangular prism and pyramids:

1)

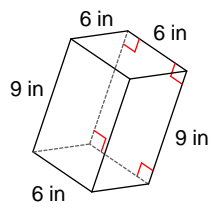

288 in^2

2)

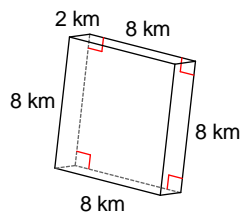

192 km^2

3)

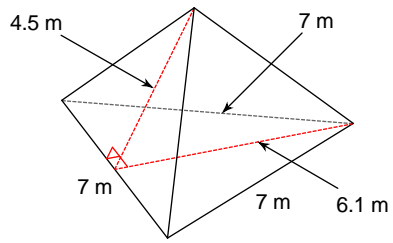

69 m²

4)

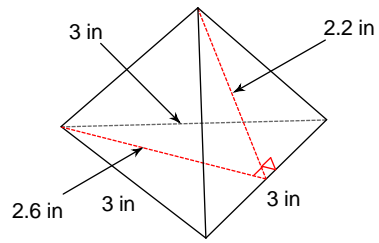

14 in²

5)

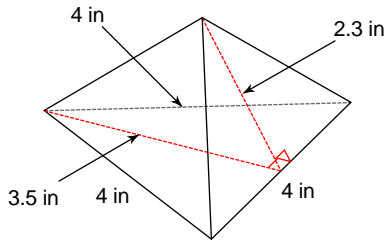

21 in^2

6)

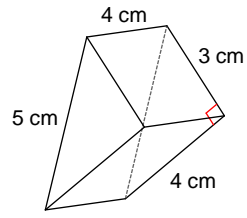

60 cm^2

7)

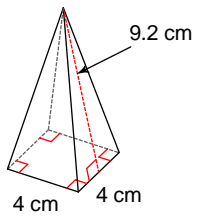

90 cm²

8)

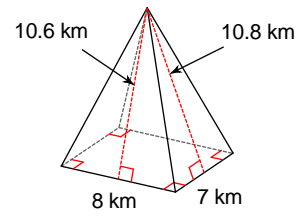

216 km²

9)

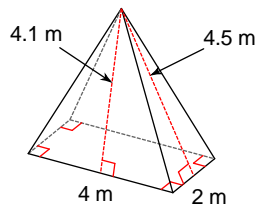

33 m²

10)

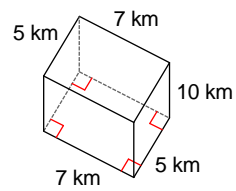

310 km²

11)

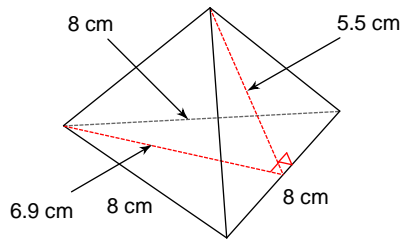

94 cm^2

12)

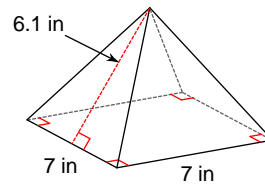

134 in^2

13)

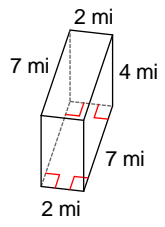

100 mi^2

14)

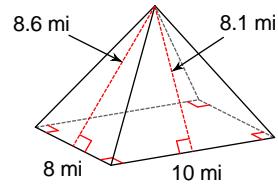

230 mi^2

15)

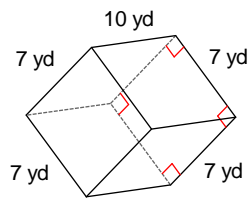

378 yd^2

16)

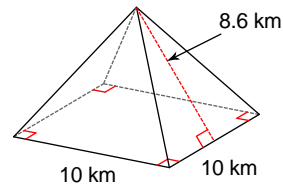

272 km^2

17)

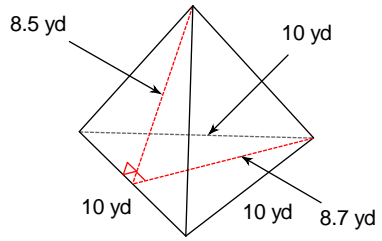

171 yd²

18)

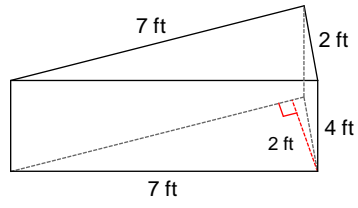

78 ft²

19)

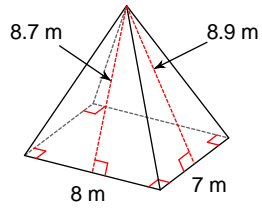

188 m²

20)

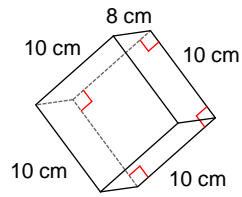

520 cm²

21)

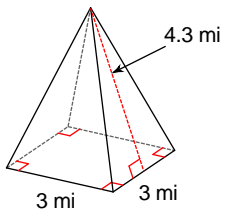

35 m^2

22)

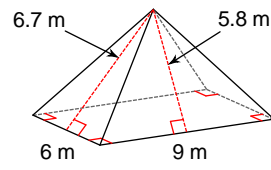

146 m^2

23)

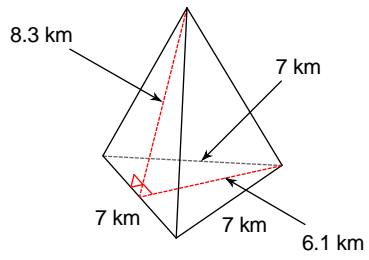

109 km²

24)

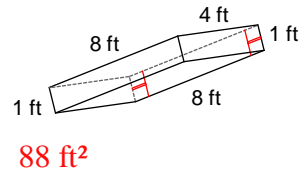

88 ft²

25)

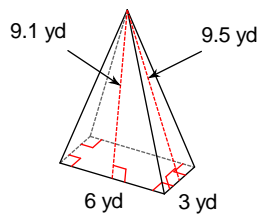

101 yd²

26)

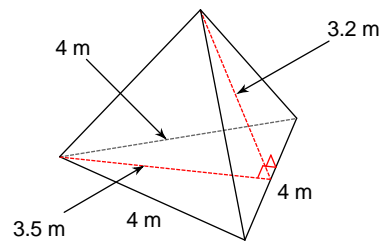

26 m²

27)

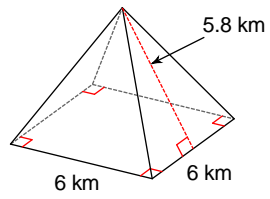

106 km²

28)

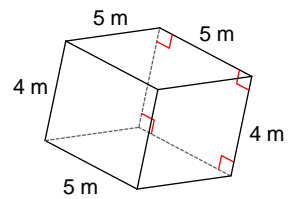

130 m²

29)

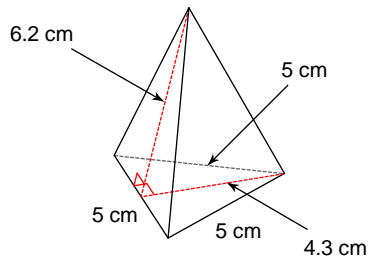

57 cm^2

30)

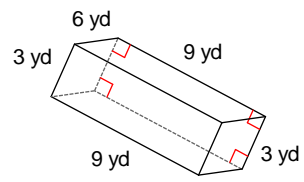

198 yd^2

31)

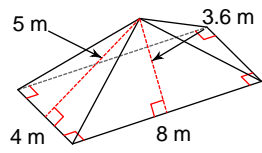

81 m^2

32)

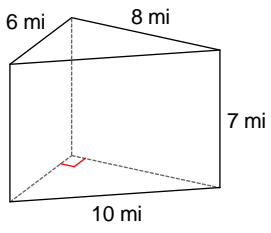

216 mi^2

33)

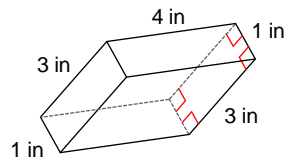

38 in^2

34)

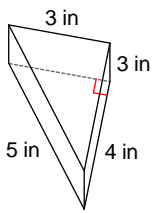

48 in^2

35)

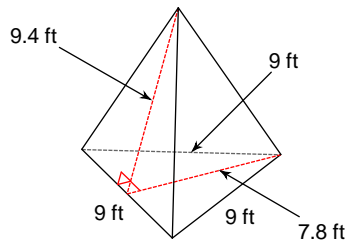

162 ft²

36)

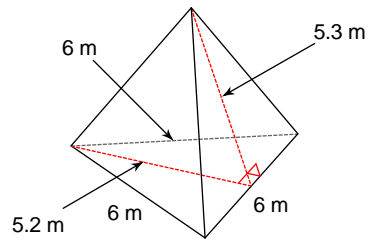

63 m²

37)

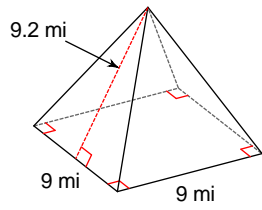

247 mi²

38)

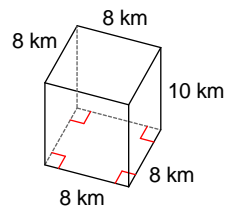

448 km²

39)

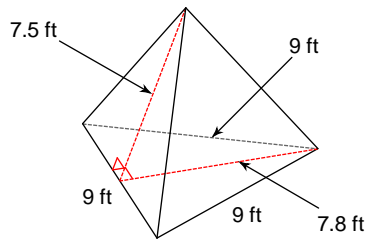

136 ft²

40)

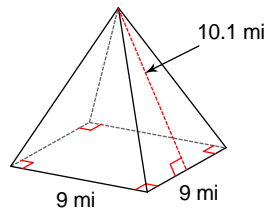

263 mi²

41)

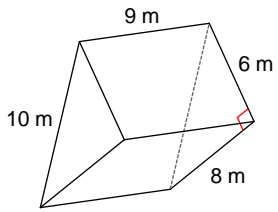

264 m²

42)

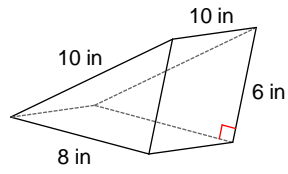

288 in²

43)

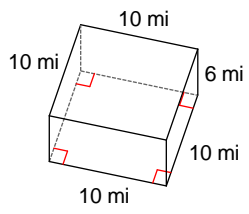

440 mi^2

44)

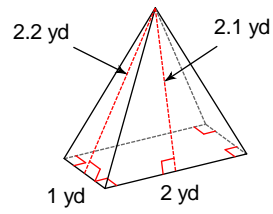

8 yd^2

45)

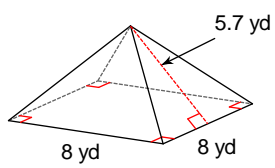

155 yd^2

46)

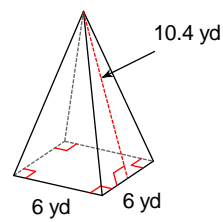

161 yd^2

47)

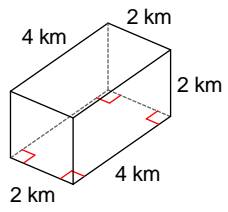

40 km^2

48)

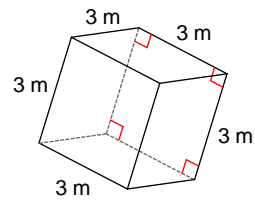

54 m^2

49)

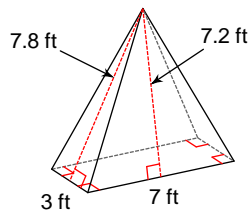

95 ft^2

50)

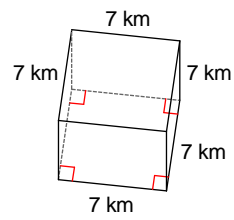

294 km^2

51)

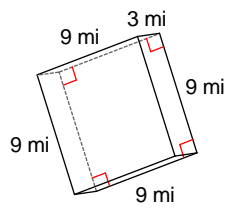

270 mi^2

52)

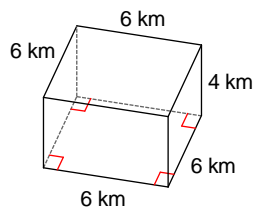

168 km^2

53)

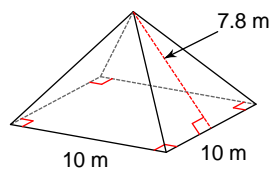

256 m^2

54)

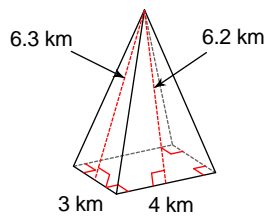

56 km^2

55)

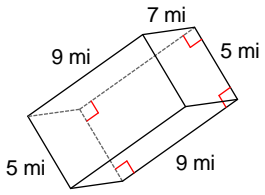

286 mi²

56)

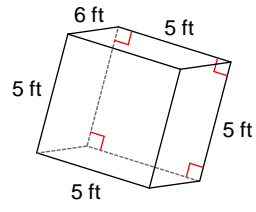

170 ft²

57)

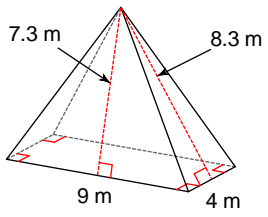

135 m²

58)

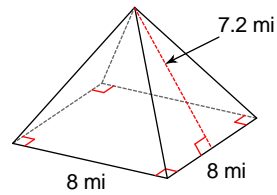

179 mi²

59)

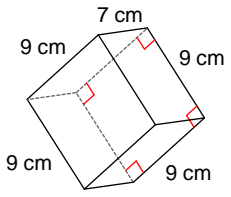

414 cm^2

60)

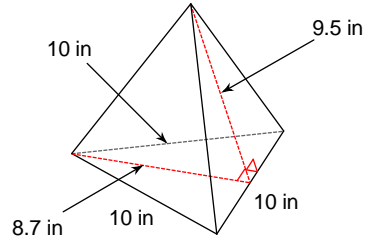

186 in^2

61)

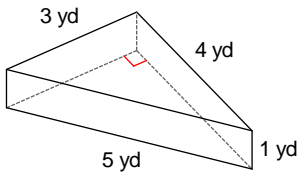

24 yd^2

62)

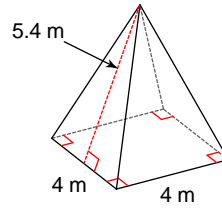

59 m^2

63)

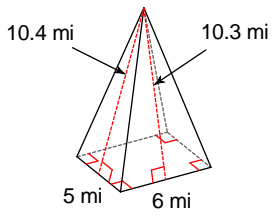

144 mi²

64)

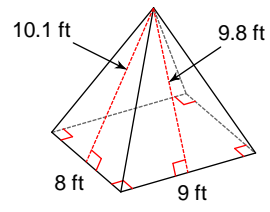

241 ft²

65)

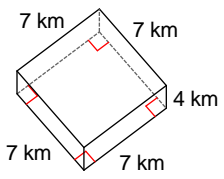

210 km²

66)

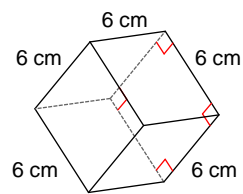

216 cm²

67)

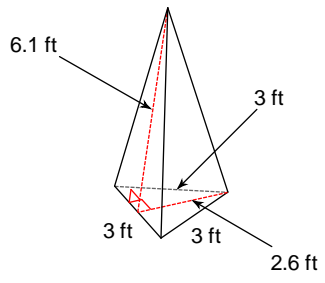

31 ft^2

68)

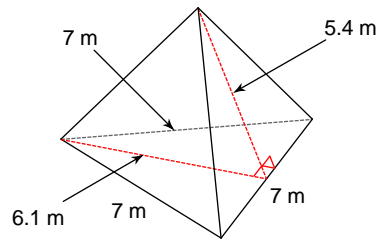

78 m^2

69)

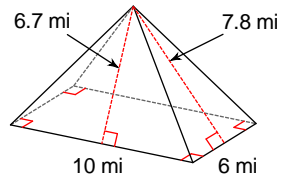

174 mi^2

70)

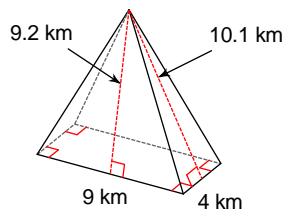

159 km²

71)

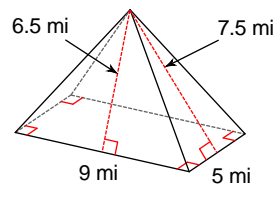

141 mi²

72)

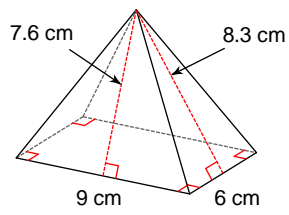

172 cm²

73)

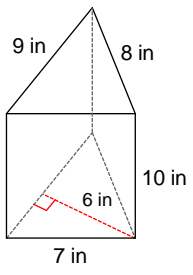

294 in^2

74)

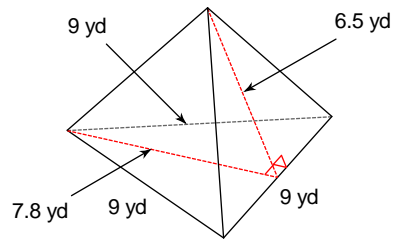

123 yd^2

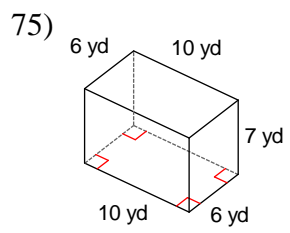

344 yd²

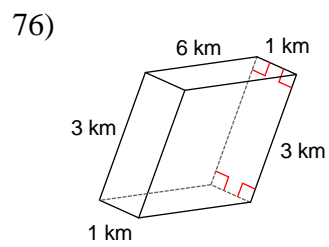

54 km²

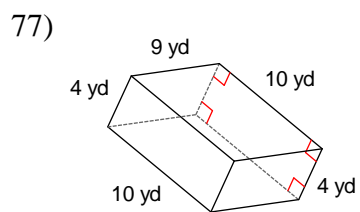

332 yd²

78)

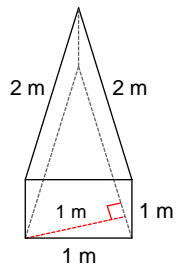

7 m^2

79)

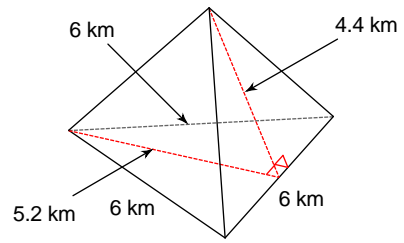

55 km^2

80)

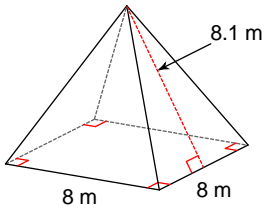

194 m²

81)

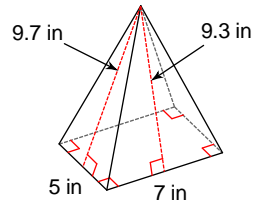

149 in²

82)

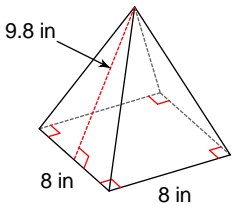

221 in²

83)

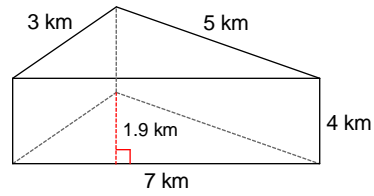

73 km²

84)

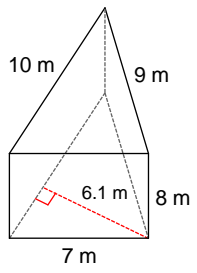

269 m^2

85)

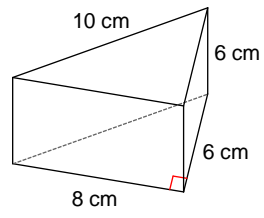

192 cm^2

86)

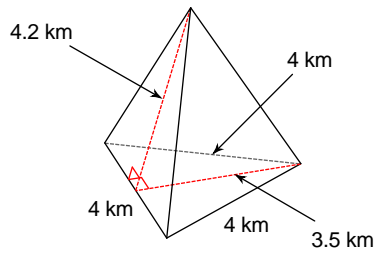

32 km^2

87)

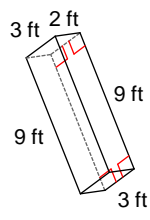

102 ft^2

88)

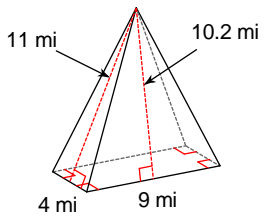

172 mi²

89)

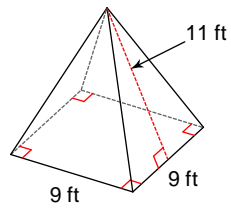

279 ft²

90)

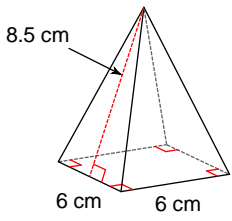

138 cm²

91)

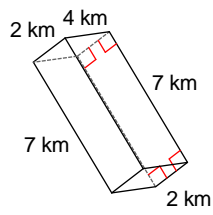

100 km²

92)

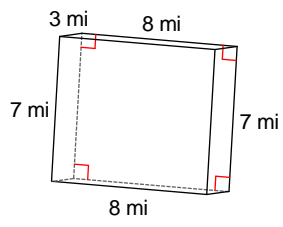

202 mi²

93)

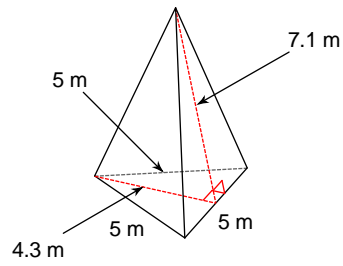

64 m²

94)

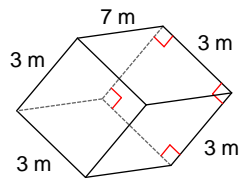

102 m²

95)

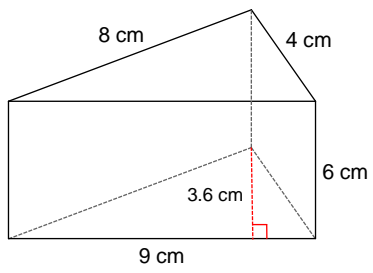

158 cm^2

96)

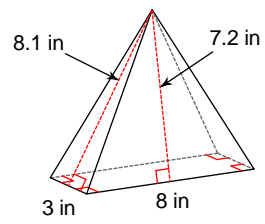

106 in^2

97)

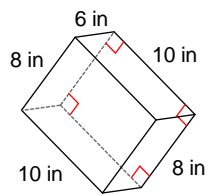

376 in^2

98)

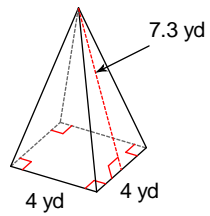

74 yd^2

99)

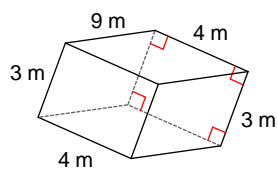

150 m^2

100)

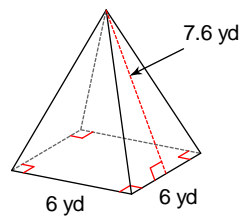

127 yd^2

Find the surface area of trapezoidal prisms, pentagonal prisms and pyramids, hexagonal prisms and pyramids:

101)

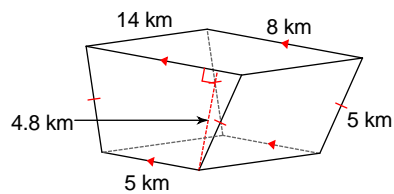

384.4 km^2

102)

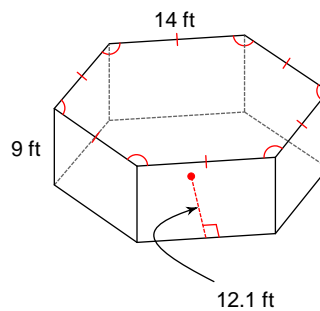

1772.4 ft^2

103)

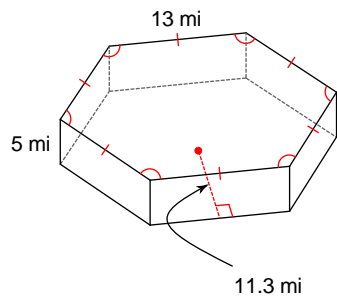

1271.4 mi^2

104)

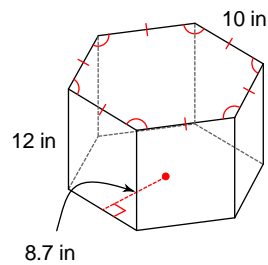

1242 in^2

105)

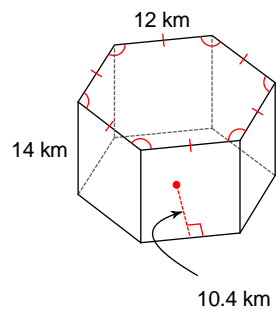

1756.8 km^2

106)

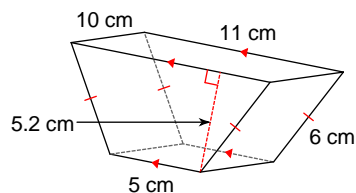

363.2 cm^2

107)

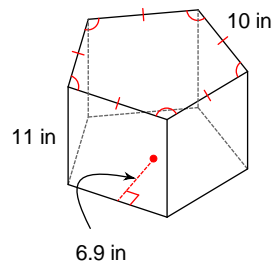

895 in^2

108)

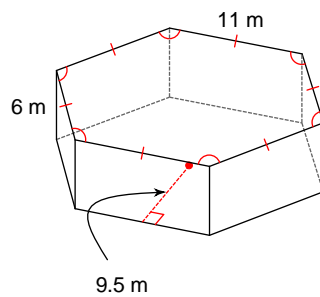

1023 m^2

109)

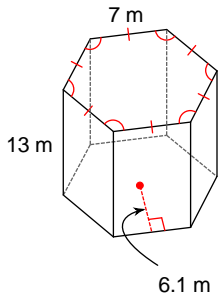

802.2 m^2

110)

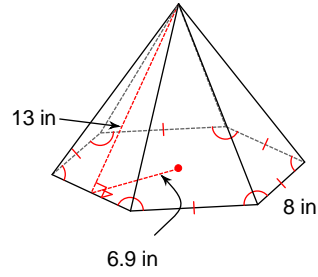

477.6 in^2

111)

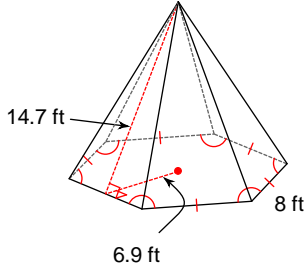

518.4 ft^2

112)

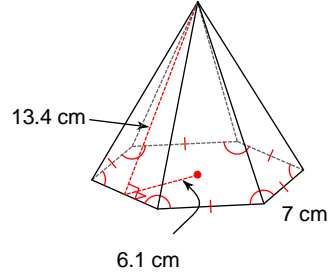

409.5 cm^2

113)

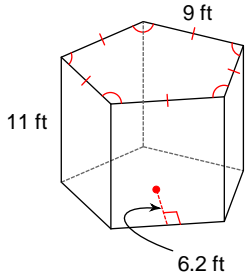

774 ft^2

114)

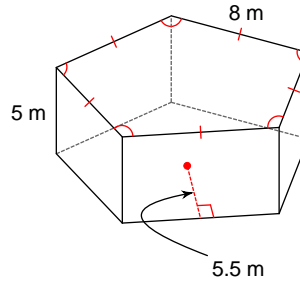

420 m^2

115)

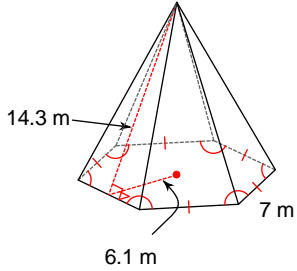

428.4 m^2

116)

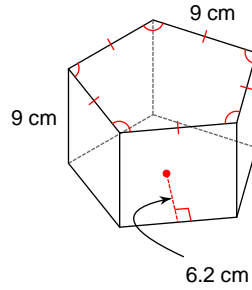

684 cm^2

117)

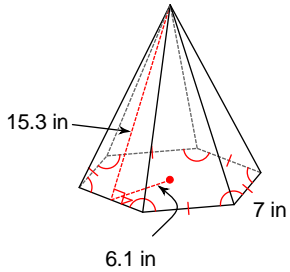

449.4 in^2

118)

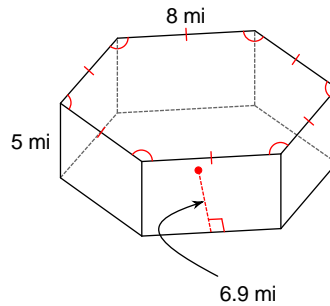

571.2 mi^2

119)

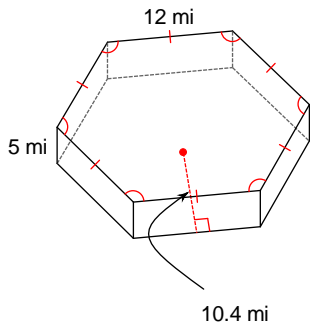

1108.8 mi²

120)

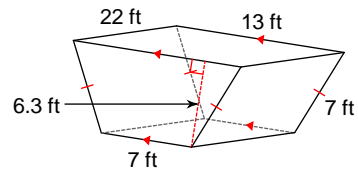

874 ft²

121)

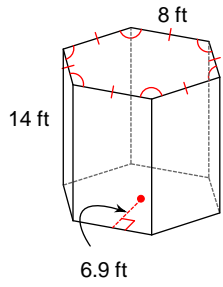

1003.2 ft²

122)

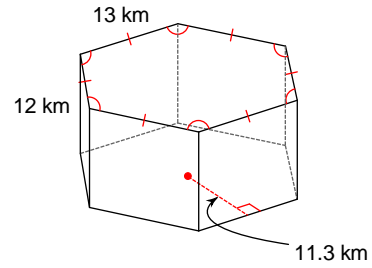

1817.4 km²

123)

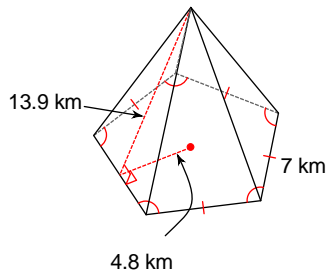

327.25 km²

124)

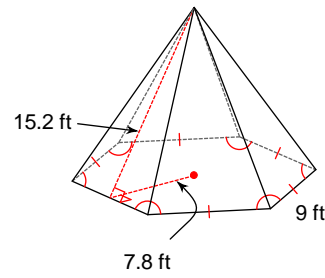

621 ft²

125)

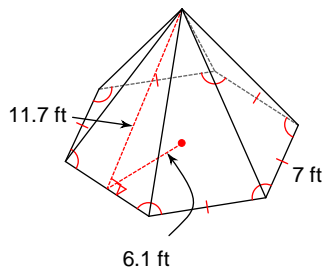

373.8 ft²

126)

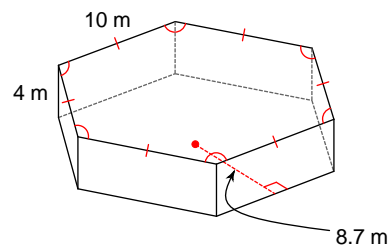

762 m²

127)

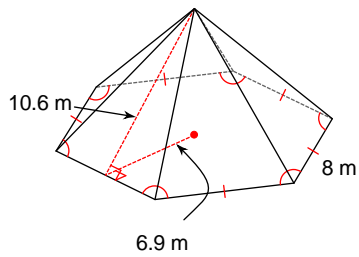

420 m²

128)

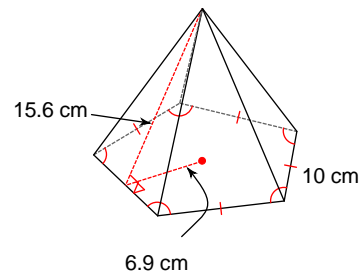

562.5 cm²

129)

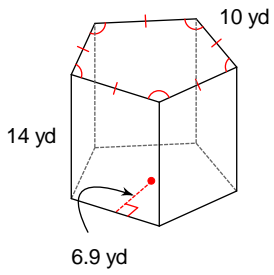

1045 yd²

130)

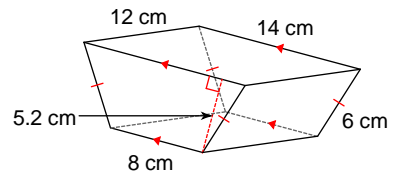

522.4 cm²

131)

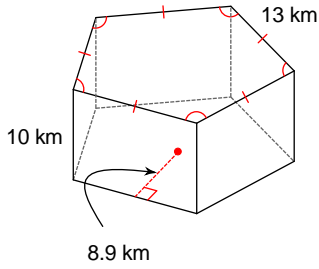

1228.5 km²

132)

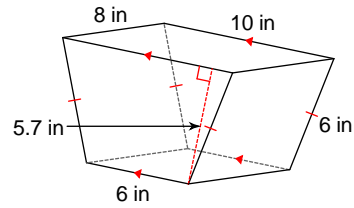

315.2 in²

133)

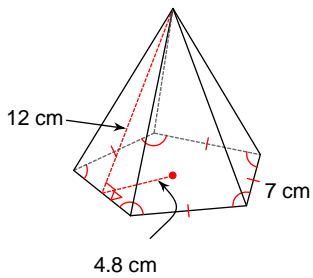

294 cm²

134)

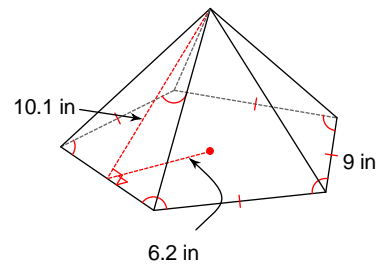

366.75 in²

135)

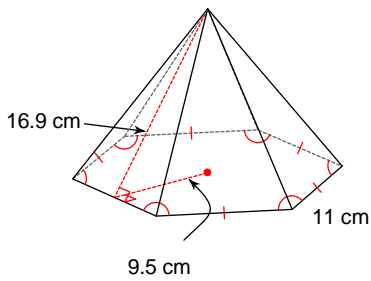

871.2 cm²

136)

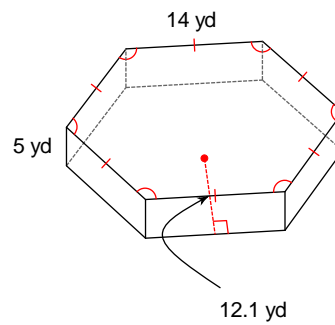

1436.4 yd²

137)

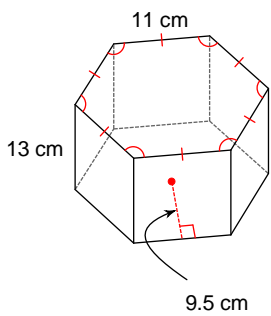

1485 cm²

138)

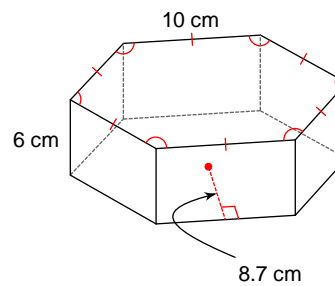

882 cm²

139)

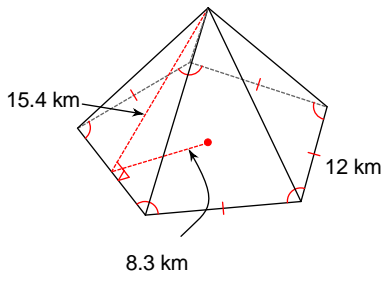

711 km²

140)

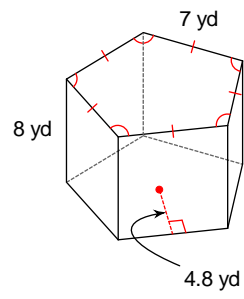

448 yd²

141)

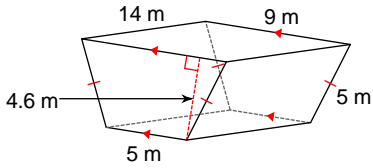

400.4 m²

142)

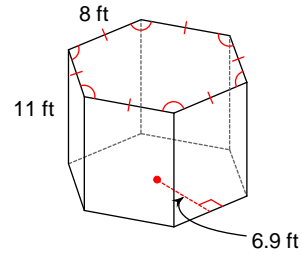

859.2 ft²

143)

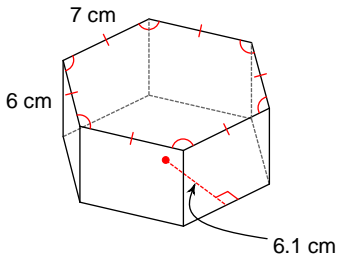

508.2 cm²

144)

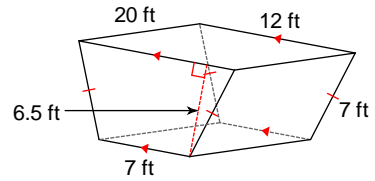

783.5 ft²

145)

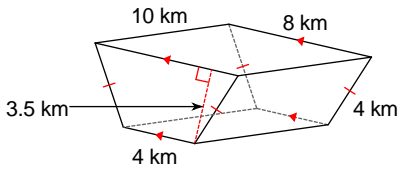

242 km²

146)

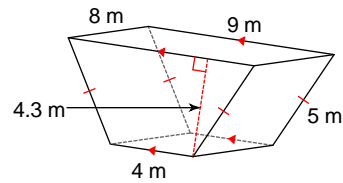

239.9 m²

147)

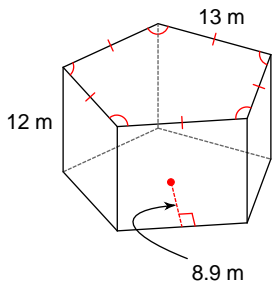

1358.5 m²

148)

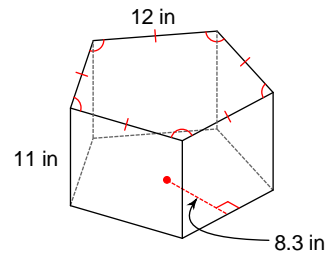

1158 in²

149)

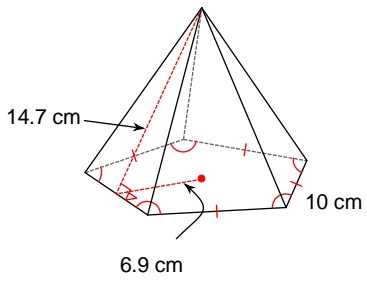

540 cm²

150)

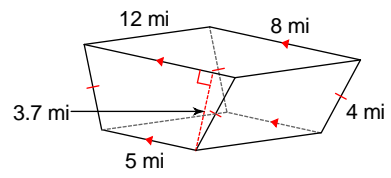

300.1 mi²

151)

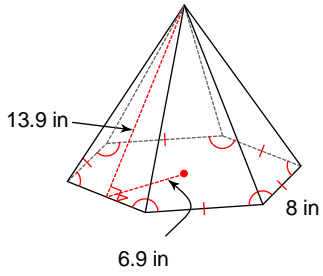

499.2 in²

152)

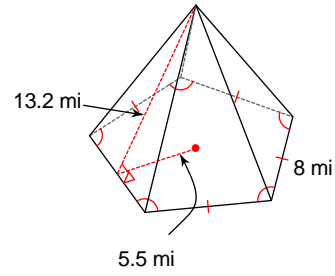

374 mi²

153)

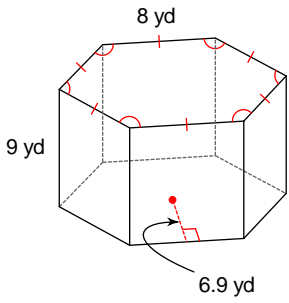

763.2 yd²

154)

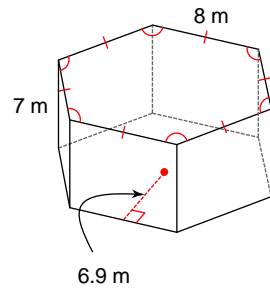

667.2 m²

155)

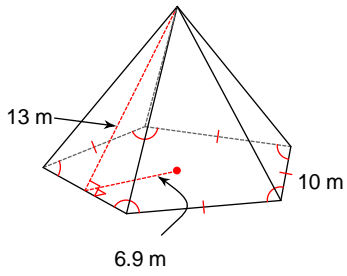

497.5 m²

156)

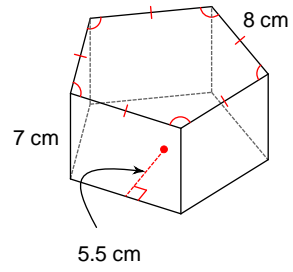

500 cm²

157)

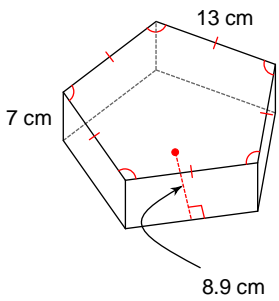

1033.5 cm²

158)

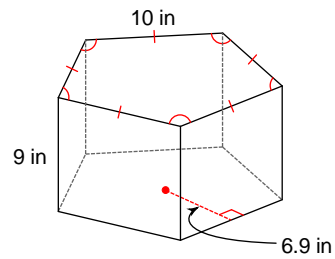

795 in²

159)

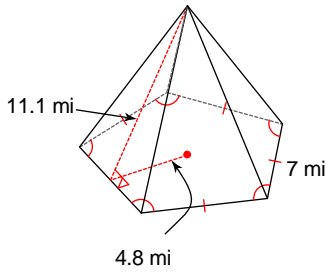

278.25 mi²

160)

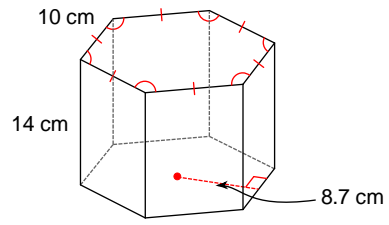

1362 cm²

161)

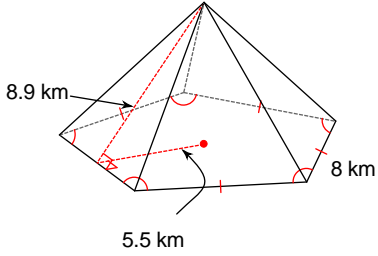

288 km²

162)

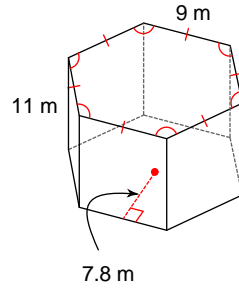

1015.2 m²

163)

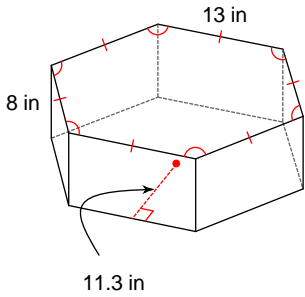

1505.4 in²

164)

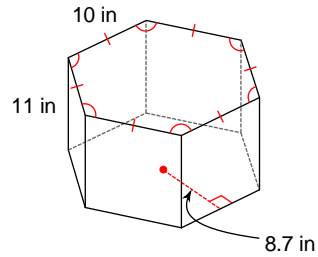

1182 in²

165)

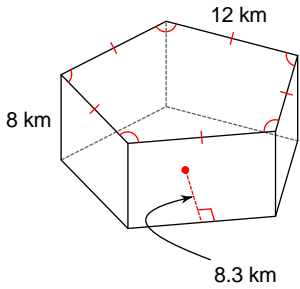

978 km²

166)

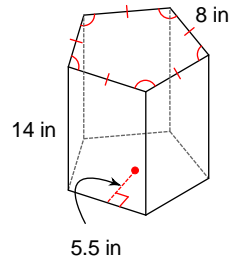

780 in²

167)

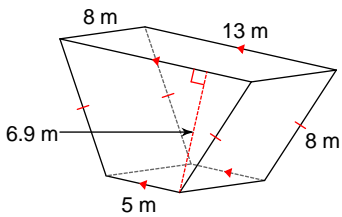

396.2 m²

168)

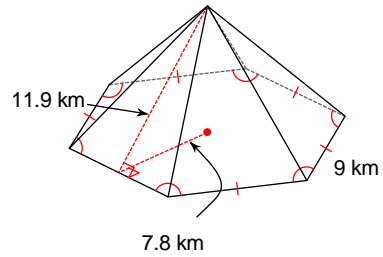

531.9 km²

169)

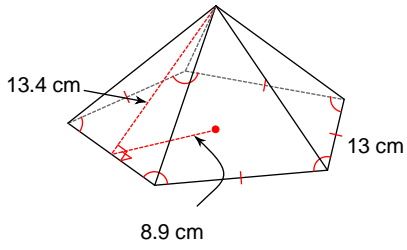

724.75 cm²

170)

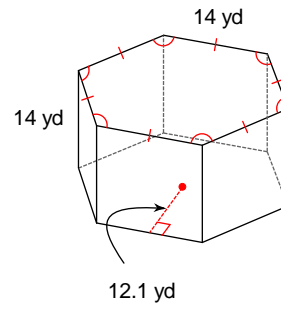

2192.4 yd²

171)

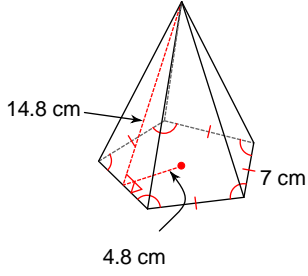

343 cm²

172)

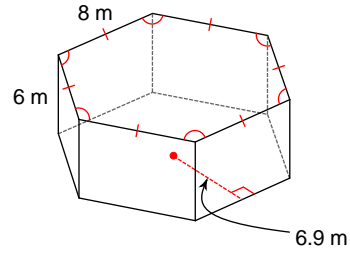

619.2 m²

173)

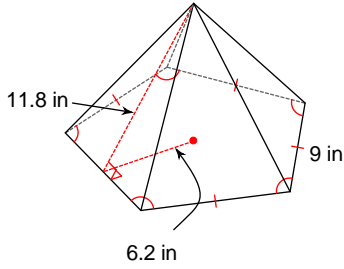

405 in²

174)

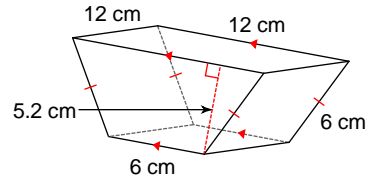

453.6 cm²

175)

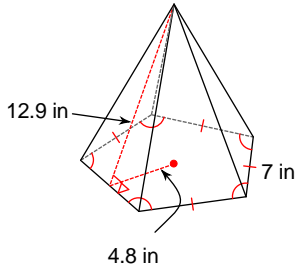

309.75 in²

176)

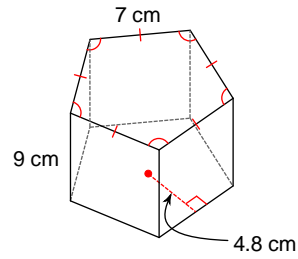

483 cm²

177)

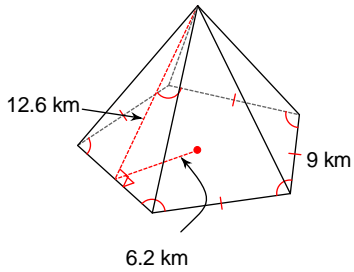

423 km²

178)

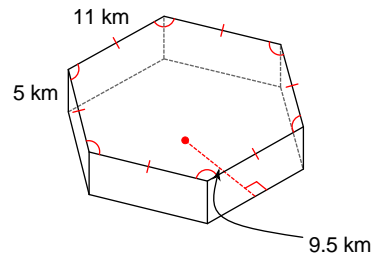

957 km²

179)

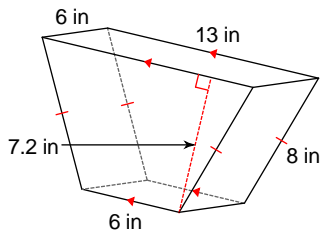

346.8 in²

180)

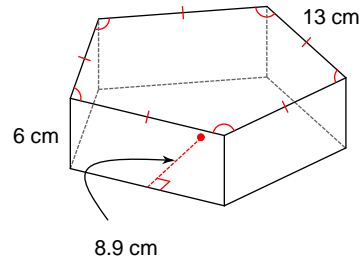

968.5 cm²

181)

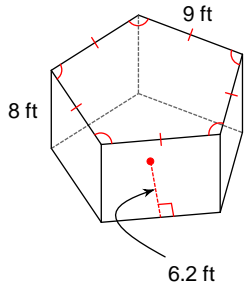

639 ft²

182)

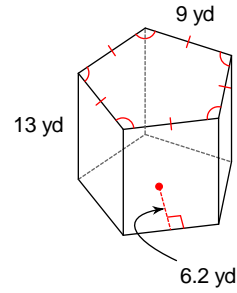

864 yd²

183)

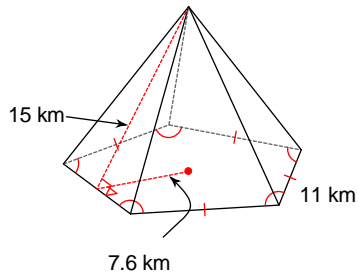

621.5 km²

184)

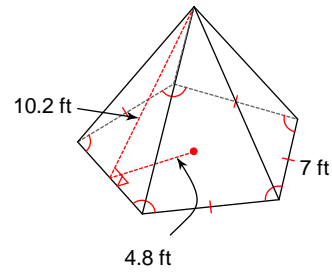

262.5 ft²

185)

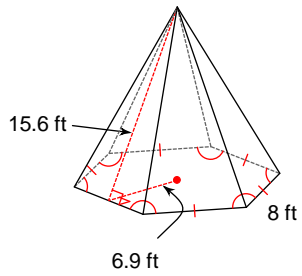

540 ft²

186)

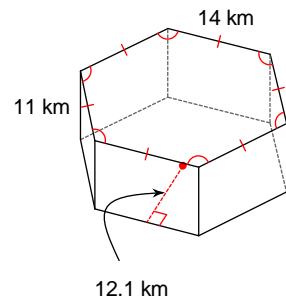

1940.4 km²

187)

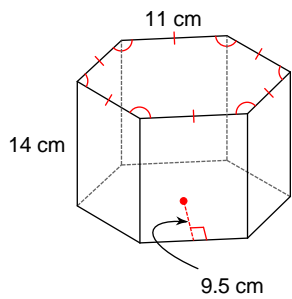

1551 cm²

188)

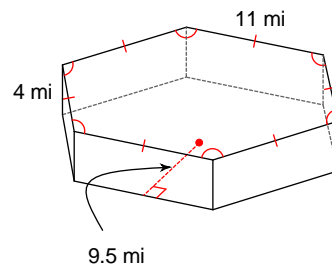

891 mi²

189)

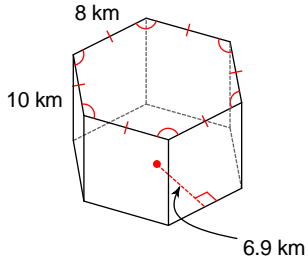

811.2 km²

190)

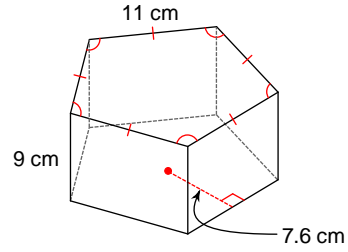

913 cm²

191)

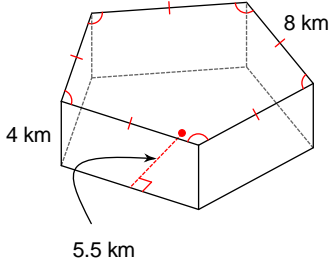

380 km²

192)

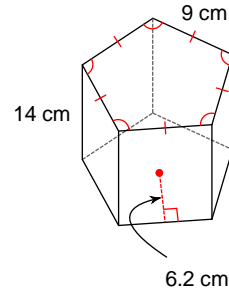

909 cm²

193)

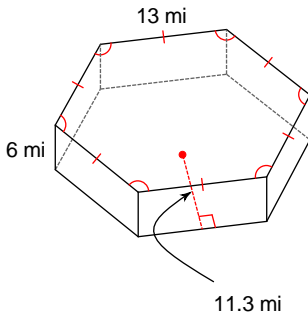

1349.4 mi²

194)

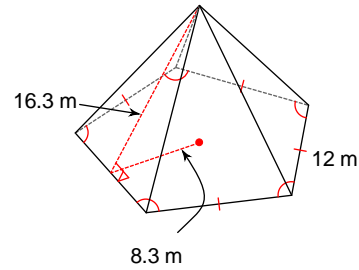

738 m²

195)

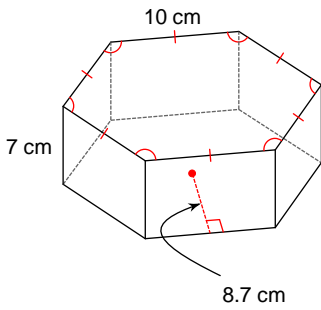

942 cm²

196)

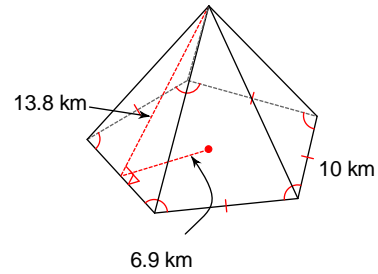

517.5 km²

197)

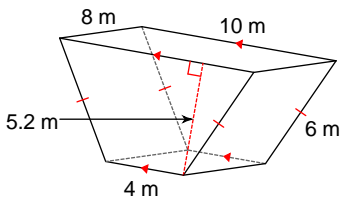

280.8 m²

198)

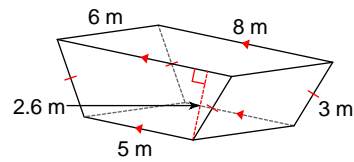

147.8 m²

199)

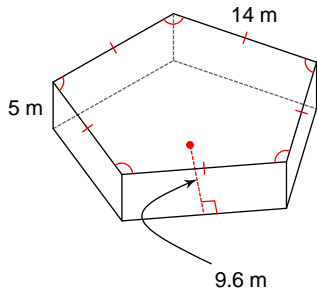

$$1022 \text{ m}^2$$

200)

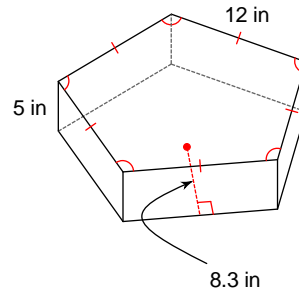

$$798 \text{ in}^2$$

Find the surface area of cylinders, cones and spheres:

201)

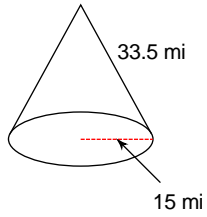

$$727.5\pi \text{ mi}^2$$

202)

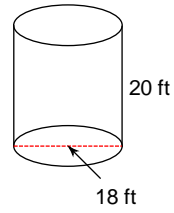

$$522\pi \text{ ft}^2$$

203)

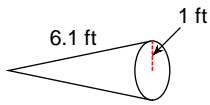

$$7.1\pi \text{ ft}^2$$

204)

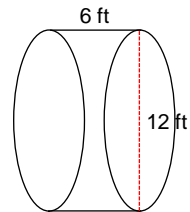

$$144\pi \text{ ft}^2$$

205)



$$261.9\pi \text{ mi}^2$$

206)

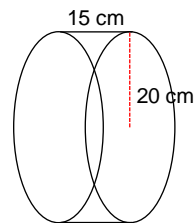

$$1400\pi \text{ cm}^2$$

207)

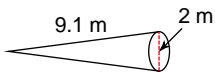

$$10.1\pi \text{ m}^2$$

208)

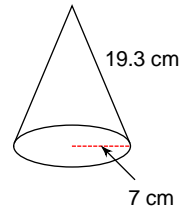

$$184.1\pi \text{ cm}^2$$

209)

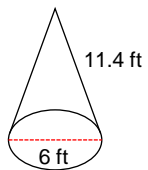

$$43.2\pi \text{ ft}^2$$

210)

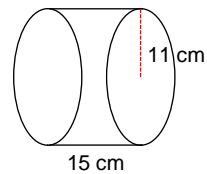

$$572\pi \text{ cm}^2$$

211)

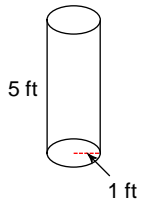

$12\pi \text{ ft}^2$

212)

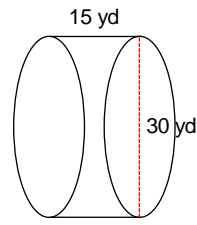

$900\pi \text{ yd}^2$

213)

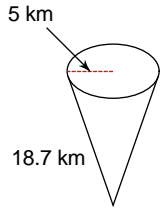

$118.5\pi \text{ km}^2$

214)

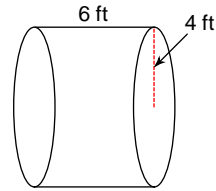

$80\pi \text{ ft}^2$

215)

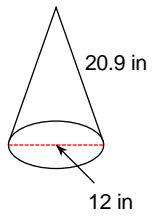

$161.4\pi \text{ in}^2$

216)

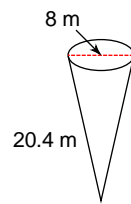

$97.6\pi \text{ m}^2$

217)

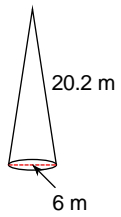

$69.6\pi \text{ m}^2$

218)

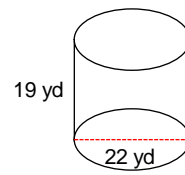

$660\pi \text{ yd}^2$

219)

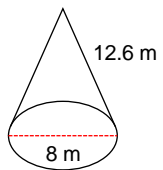

$66.4\pi \text{ m}^2$

220)

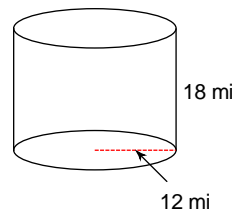

$720\pi \text{ mi}^2$

221)

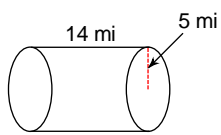

$190\pi \text{ mi}^2$

222)

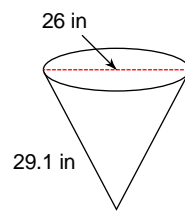

$547.3\pi \text{ in}^2$

223)

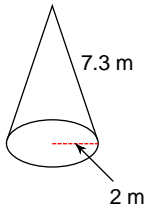

$18.6\pi \text{ m}^2$

224)

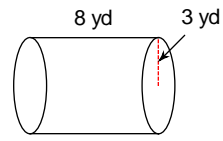

$66\pi \text{ yd}^2$

225)

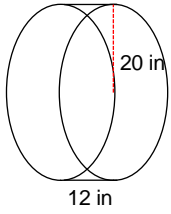

$1280\pi \text{ in}^2$

226)

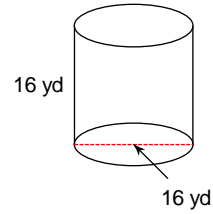

$384\pi \text{ yd}^2$

227)

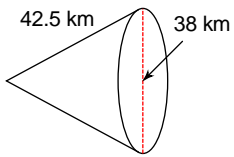

$1168.5\pi \text{ km}^2$

228)

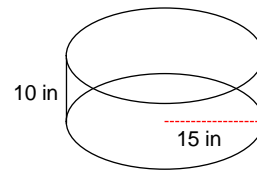

$750\pi \text{ in}^2$

229)

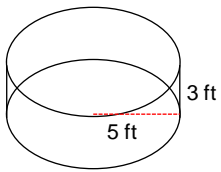

$80\pi \text{ ft}^2$

230)

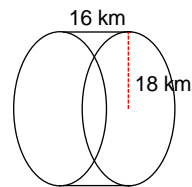

$1224\pi \text{ km}^2$

231)

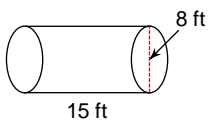

$152\pi \text{ ft}^2$

232)

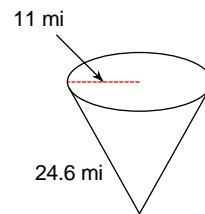

$391.6\pi \text{ mi}^2$

233)

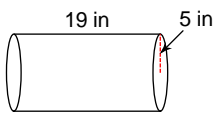

$240\pi \text{ in}^2$

234)

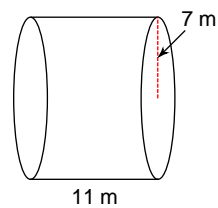

$252\pi \text{ m}^2$

235)

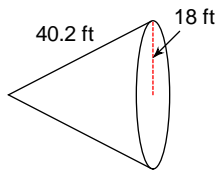

$1047.6\pi \text{ ft}^2$

237)

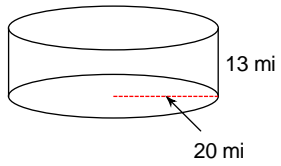

$1320\pi \text{ mi}^2$

239)

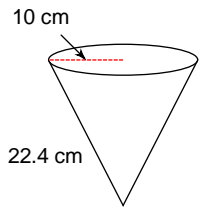

$324\pi \text{ cm}^2$

241)

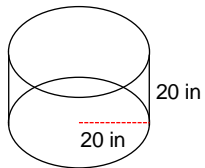

$1600\pi \text{ in}^2$

243)

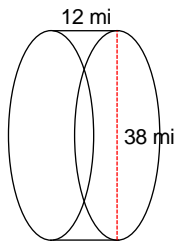

$1178\pi \text{ mi}^2$

245)

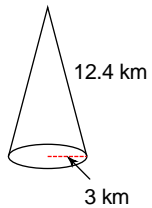

$46.2\pi \text{ km}^2$

247)

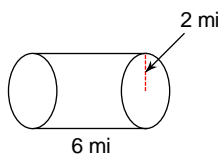

$32\pi \text{ mi}^2$

236)

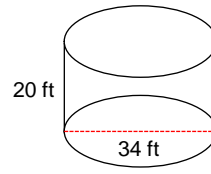

$1258\pi \text{ ft}^2$

238)

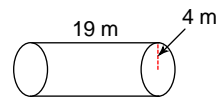

$184\pi \text{ m}^2$

240)

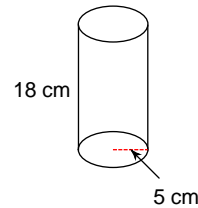

$230\pi \text{ cm}^2$

242)

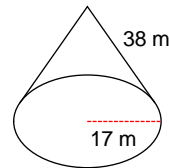

$935\pi \text{ m}^2$

244)

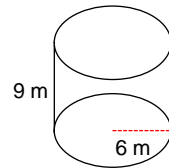

$180\pi \text{ m}^2$

246)

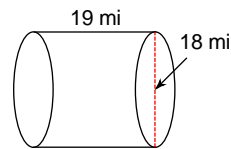

$504\pi \text{ mi}^2$

248)

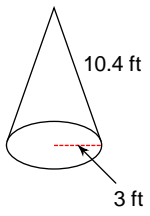

$40.2\pi \text{ ft}^2$

250)

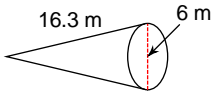

$57.9\pi \text{ m}^2$

252)

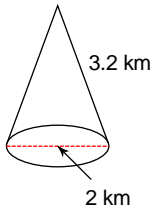

$4.2\pi \text{ km}^2$

254)

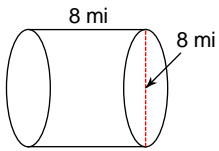

$96\pi \text{ mi}^2$

256)

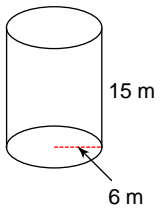

$252\pi \text{ m}^2$

258)

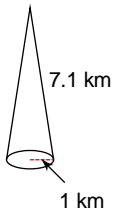

$8.1\pi \text{ km}^2$

249)

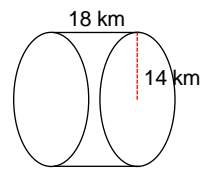

$896\pi \text{ km}^2$

251)

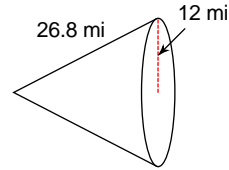

$465.6\pi \text{ mi}^2$

253)

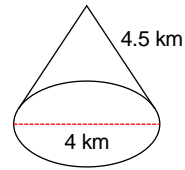

$13\pi \text{ km}^2$

255)

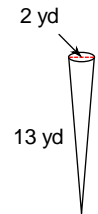

$14\pi \text{ yd}^2$

257)

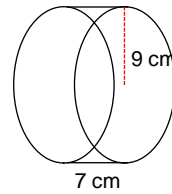

$288\pi \text{ cm}^2$

259)

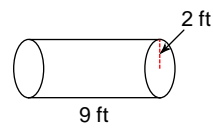

$44\pi \text{ ft}^2$

260)

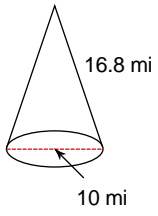

$109\pi \text{ mi}^2$

261)

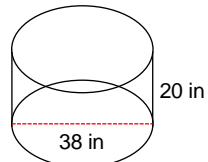

$1482\pi \text{ in}^2$

262)

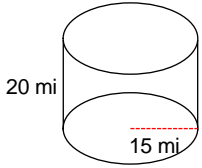

$1050\pi \text{ mi}^2$

263)

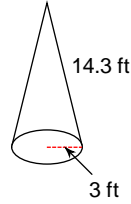

$51.9\pi \text{ ft}^2$

264)

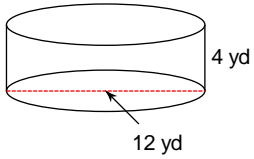

$120\pi \text{ yd}^2$

265)

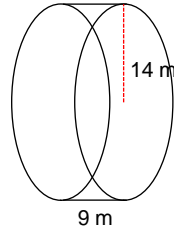

$644\pi \text{ m}^2$

266)



$60.9\pi \text{ mi}^2$

267)

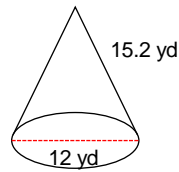

$127.2\pi \text{ yd}^2$

268)

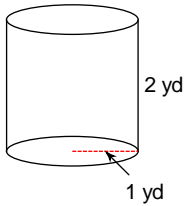

$6\pi \text{ yd}^2$

269)

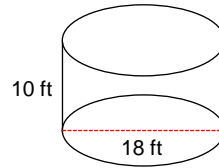

$342\pi \text{ ft}^2$

270)

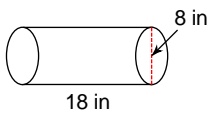

$176\pi \text{ in}^2$

271)

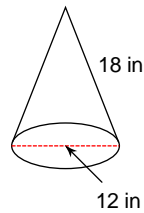

$144\pi \text{ in}^2$

272)

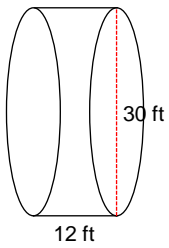

$$810\pi \text{ ft}^2$$

274)

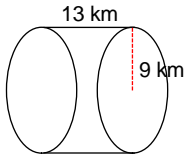

$$396\pi \text{ km}^2$$

276)

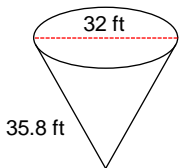

$$828.8\pi \text{ ft}^2$$

278)

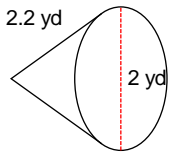

$$3.2\pi \text{ yd}^2$$

280)

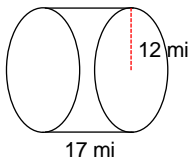

$$696\pi \text{ mi}^2$$

282)

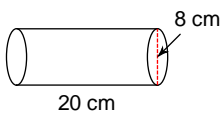

$$192\pi \text{ cm}^2$$

273)

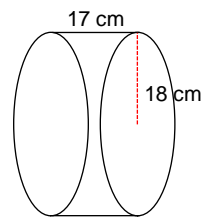

$$1260\pi \text{ cm}^2$$

275)

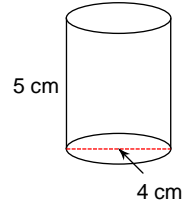

$$28\pi \text{ cm}^2$$

277)

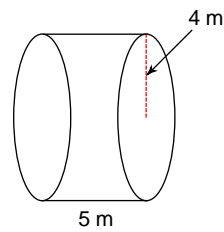

$$72\pi \text{ m}^2$$

279)

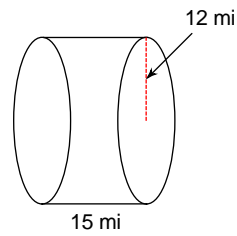

$$648\pi \text{ mi}^2$$

281)

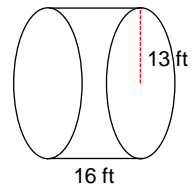

$$754\pi \text{ ft}^2$$

283)

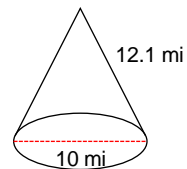

$$85.5\pi \text{ mi}^2$$

284)

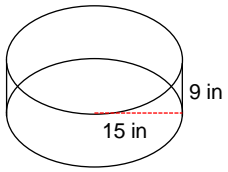

$720\pi \text{ in}^2$

285)

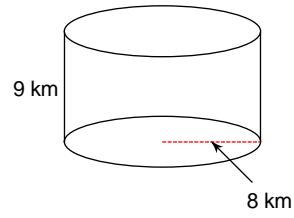

$272\pi \text{ km}^2$

286)

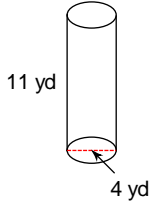

$52\pi \text{ yd}^2$

287)

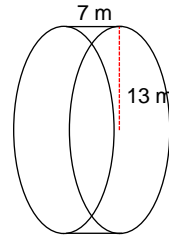

$520\pi \text{ m}^2$

288)

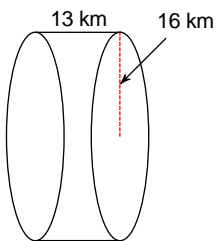

$928\pi \text{ km}^2$

289)

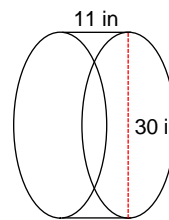

$780\pi \text{ in}^2$

290)

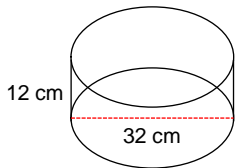

$896\pi \text{ cm}^2$

291)

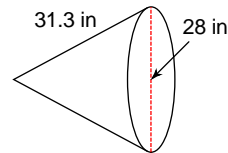

$634.2\pi \text{ in}^2$

292)

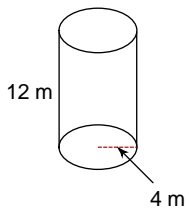

$128\pi \text{ m}^2$

293)

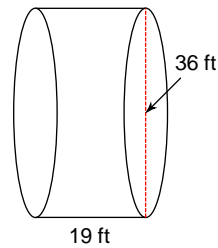

$1332\pi \text{ ft}^2$

294)

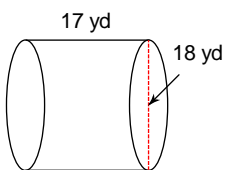

$468\pi \text{ yd}^2$

295)



$1294\pi \text{ mi}^2$

296)

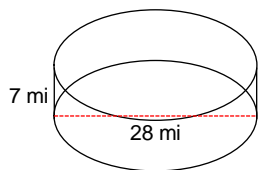

$588\pi \text{ mi}^2$

298)

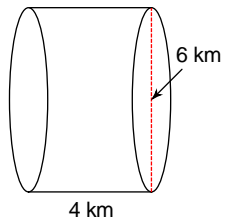

$42\pi \text{ km}^2$

300)

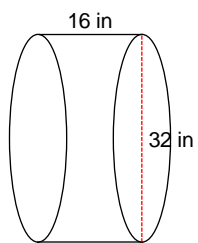

$1024\pi \text{ in}^2$

297)

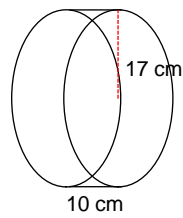

$918\pi \text{ cm}^2$

299)

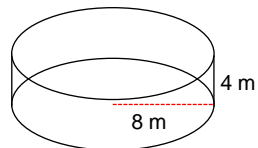

$192\pi \text{ m}^2$