

The sum of angles in a triangle - Multi-step solving

Find the value of x in multi-step equations:

1)

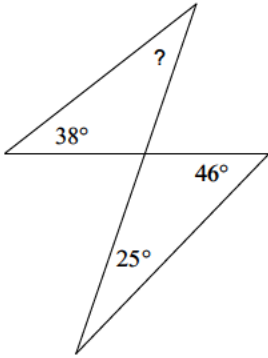

2)

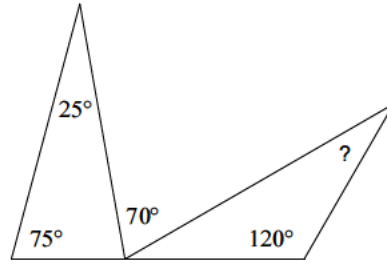

3)

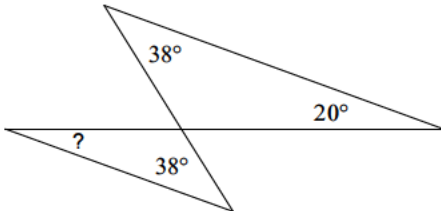

4)

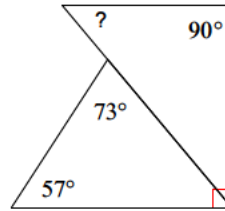

5)

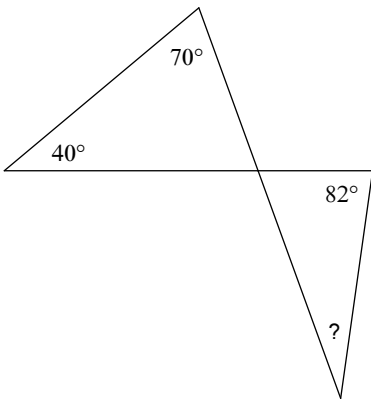

6)

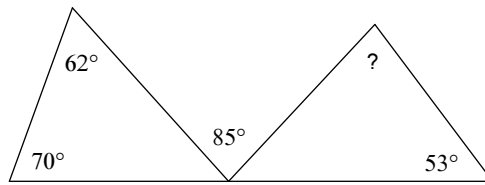

7)

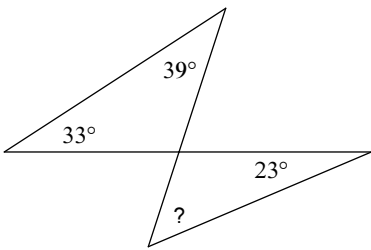

8)

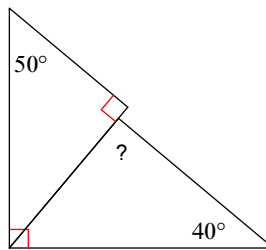

9)

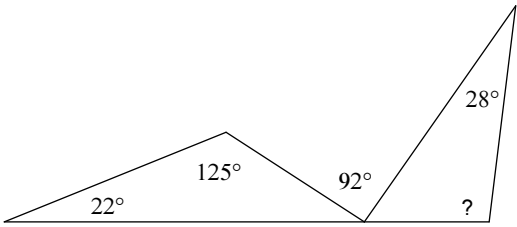

10)

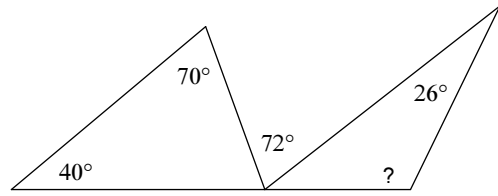

11)

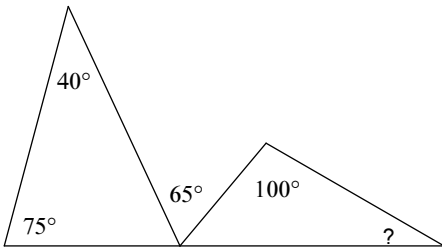

12)

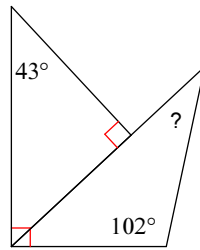

13)

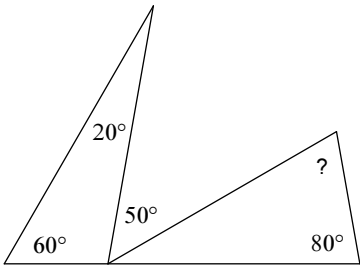

14)

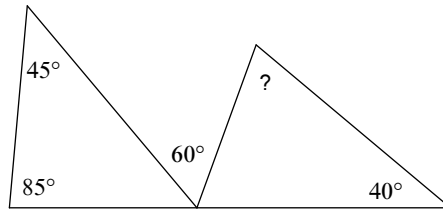

15)

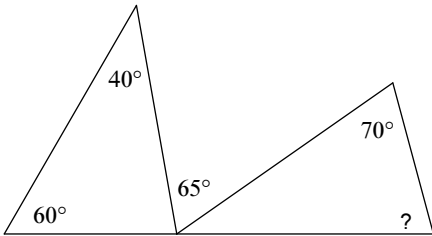

16)

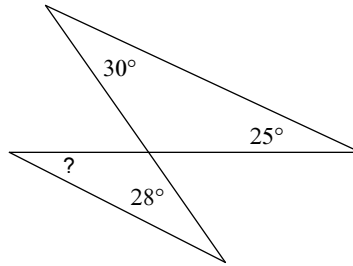

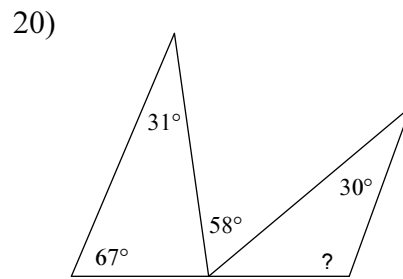
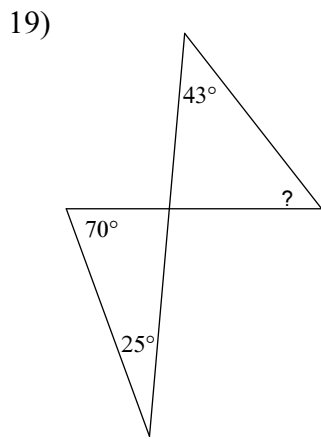
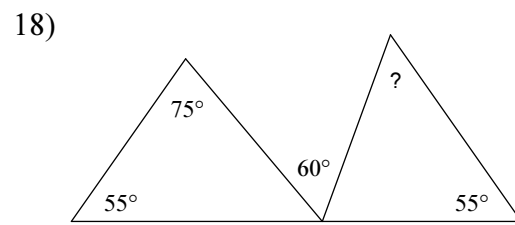
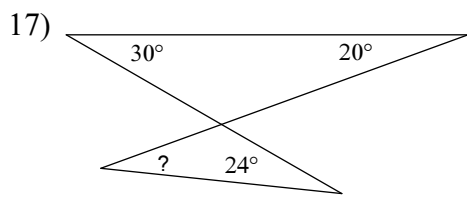

21)

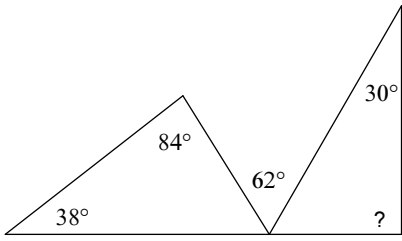

22)

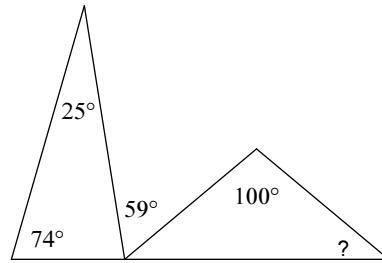

23)

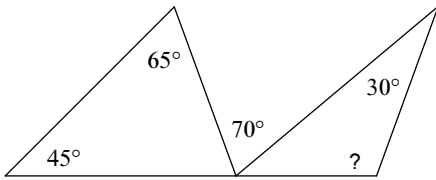

24)

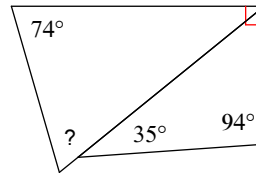

25)

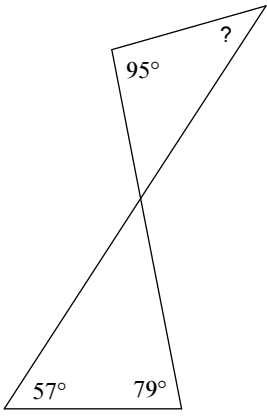

26)

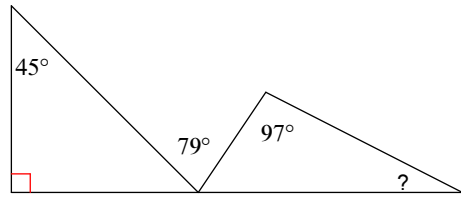

27)

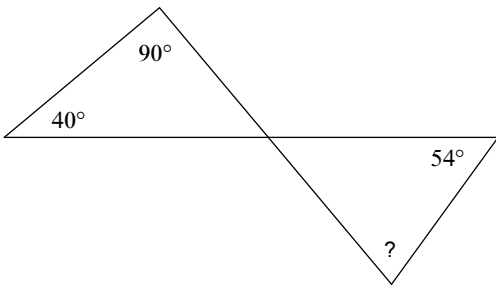

28)

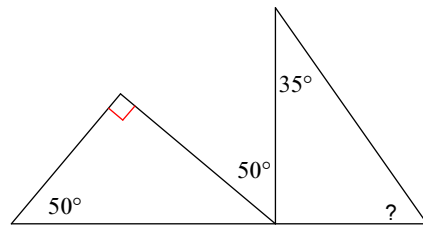

29)

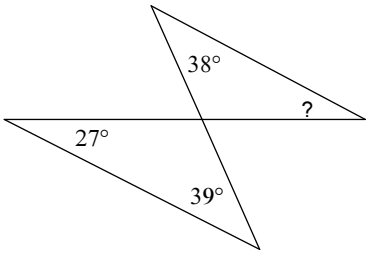

30)

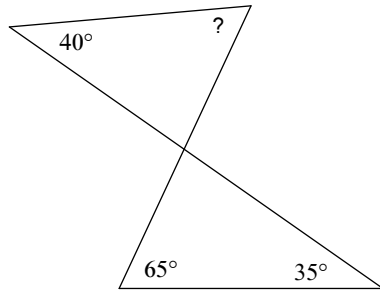

31)

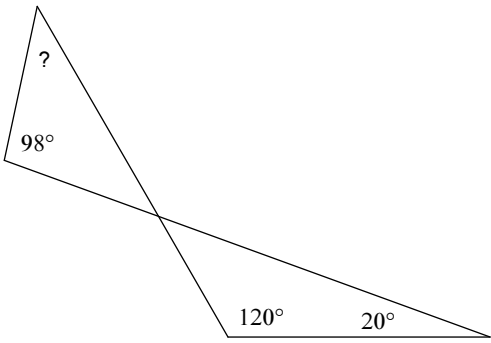

32)

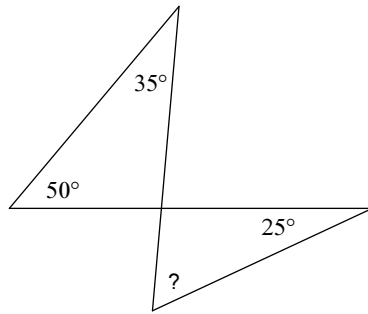

33)

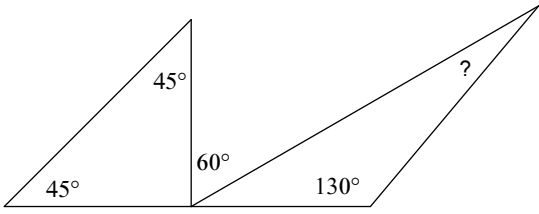

34)

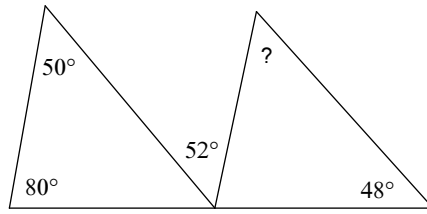

35)

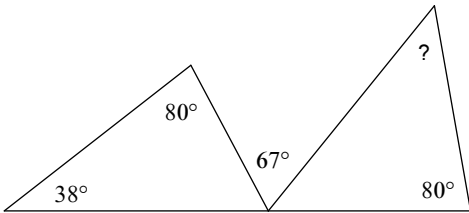

36)

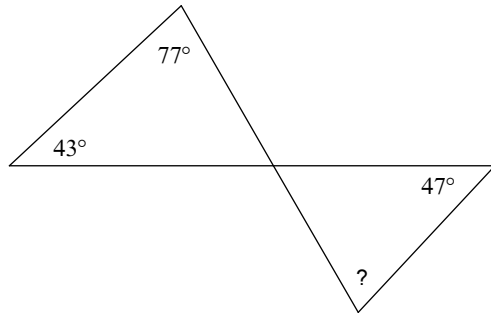

37)

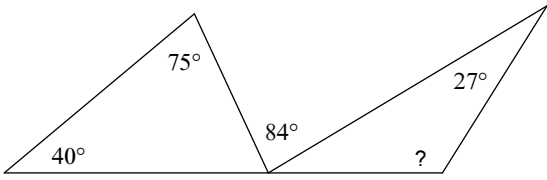

38)

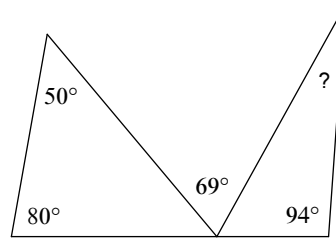

39)

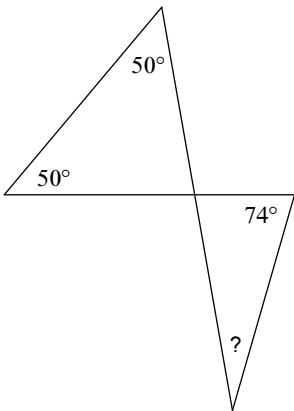

40)

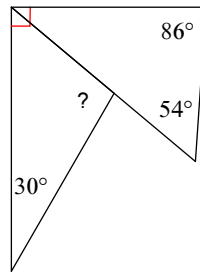

41)

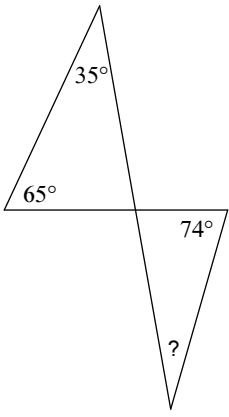

42)

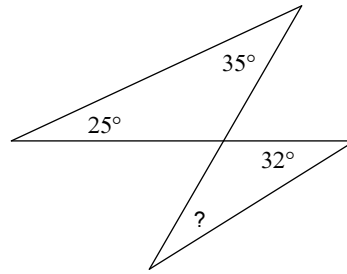

43)

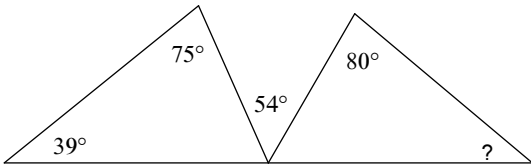

44)

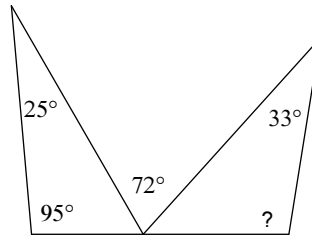

45)

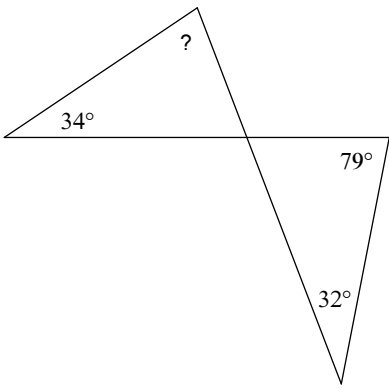

46)

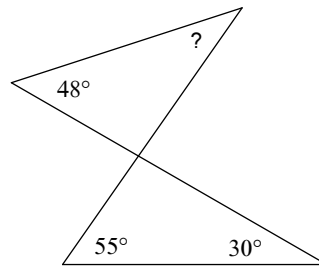

47)

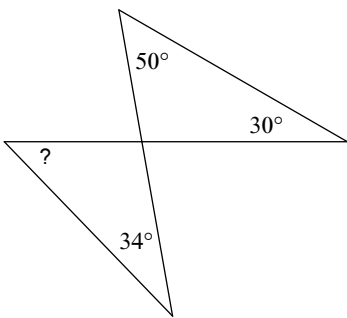

48)

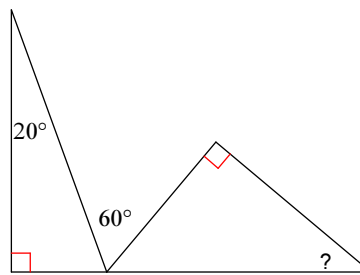

49)

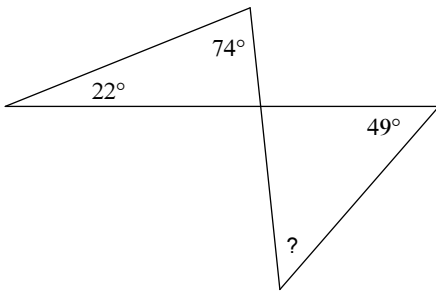

50)

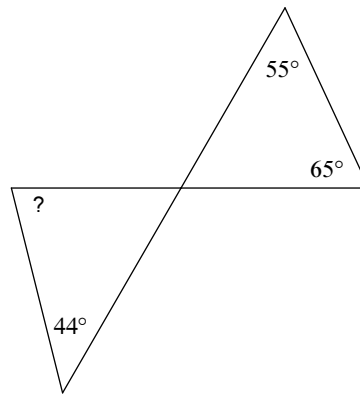

51)

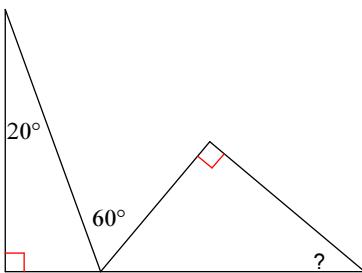

52)

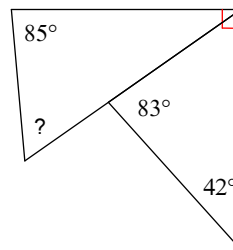

53)

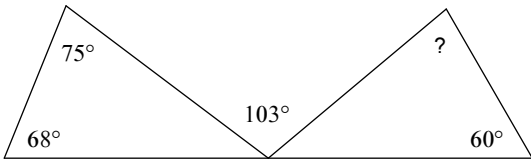

54)

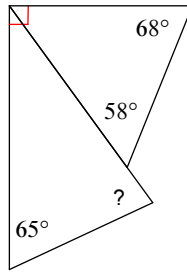

55)

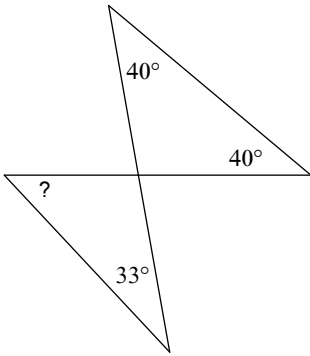

56)

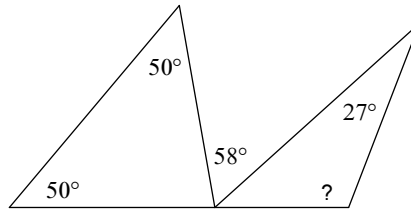

57)

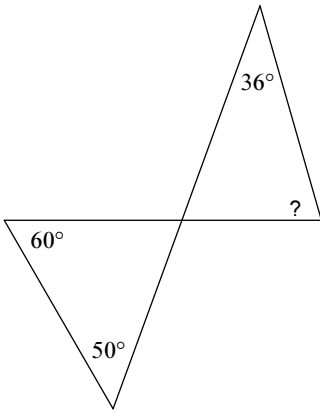

58)

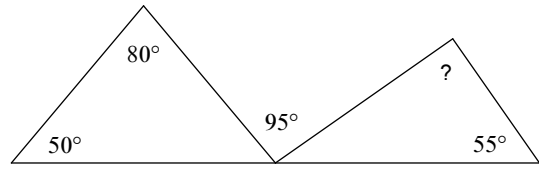

59)

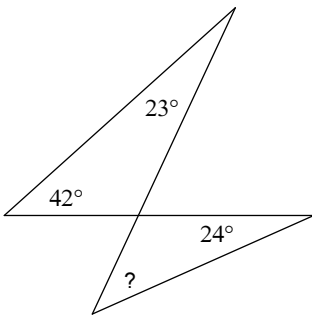

60)

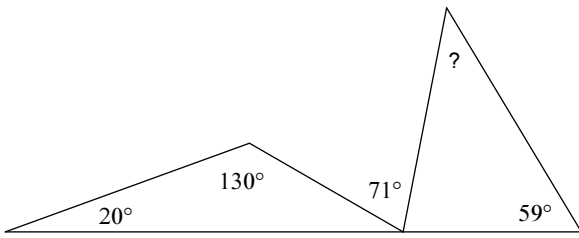

61)

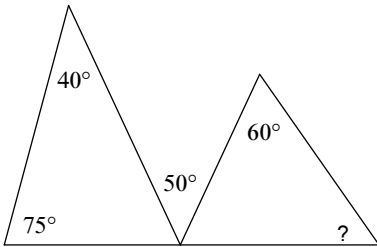

62)

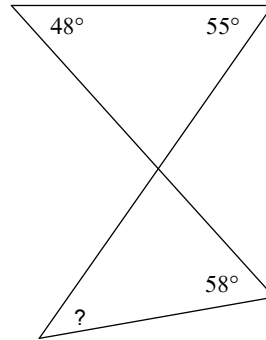

63)

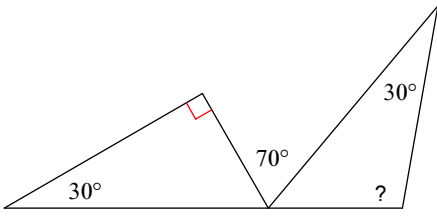

64)

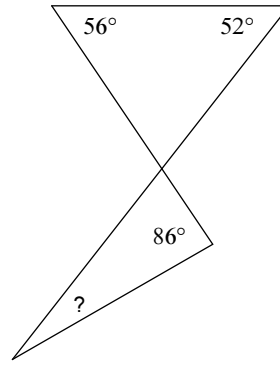

65)

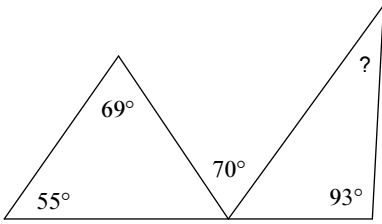

66)

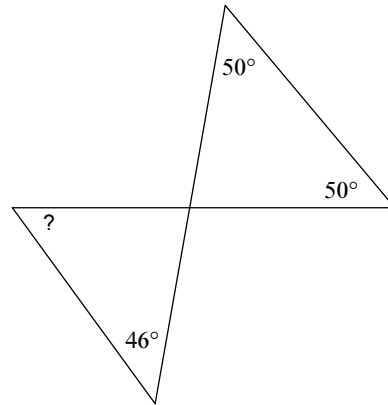

67)

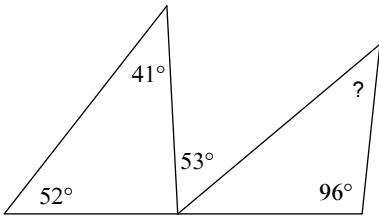

68)

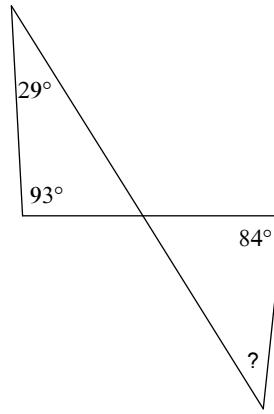

69)

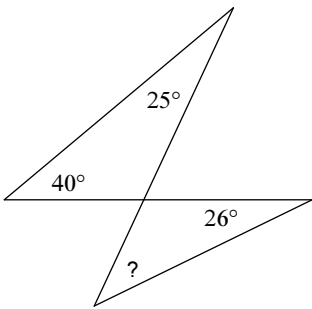

70)

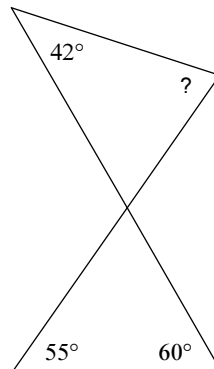

71)

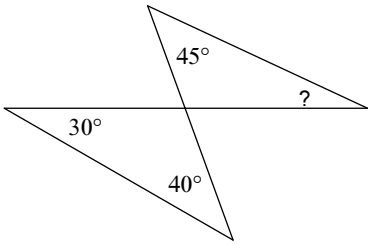

72)

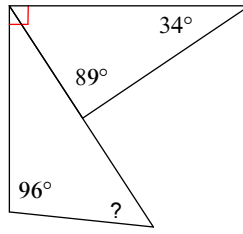

73)

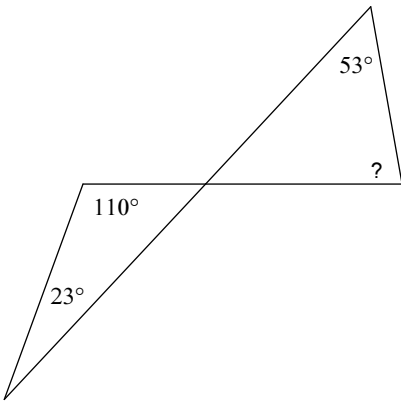

74)

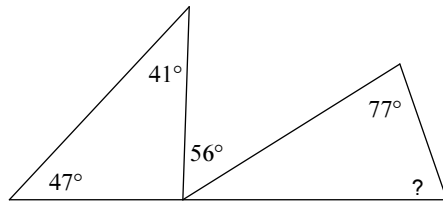

75)

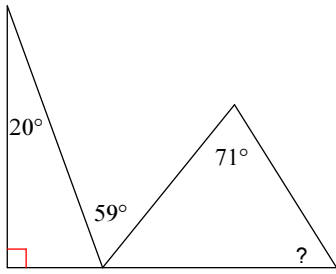

76)

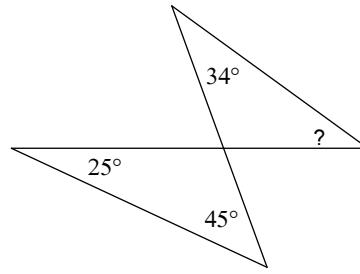

77)

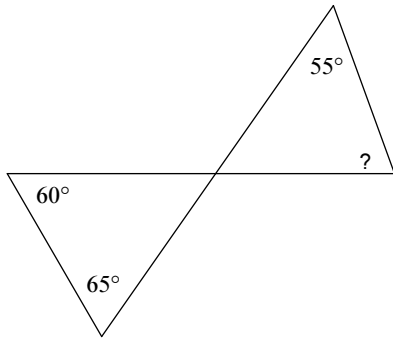

78)

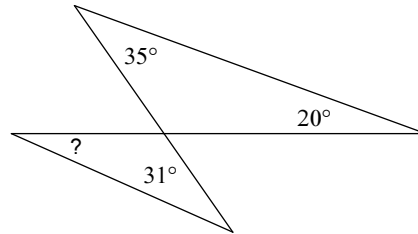

79)

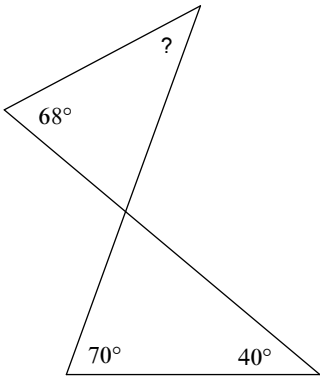

80)

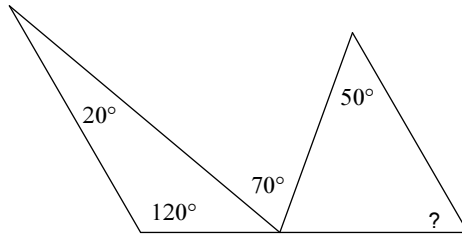

81)

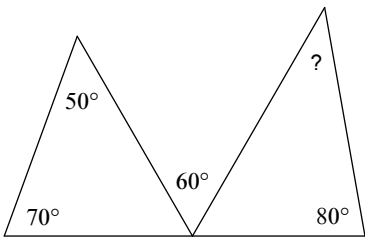

82)

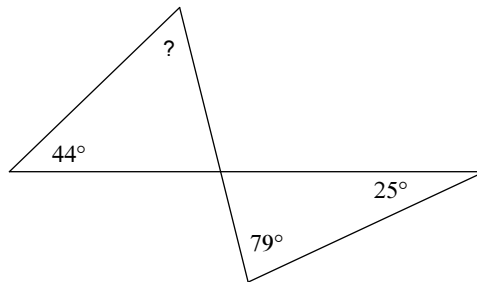

83)

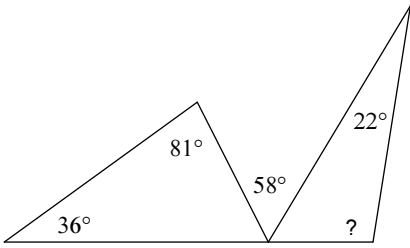

84)

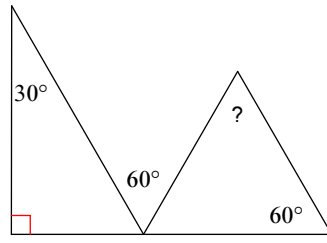

85)

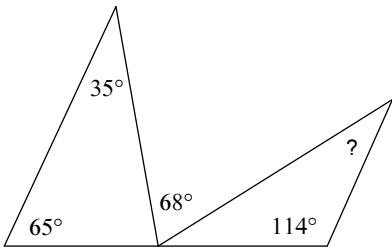

86)

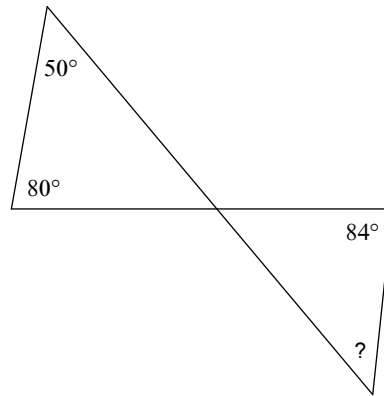

87)

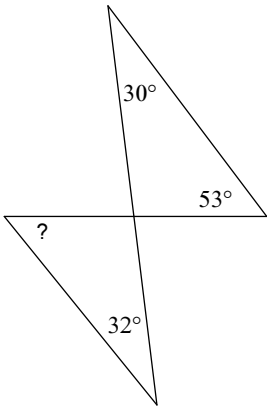

88)

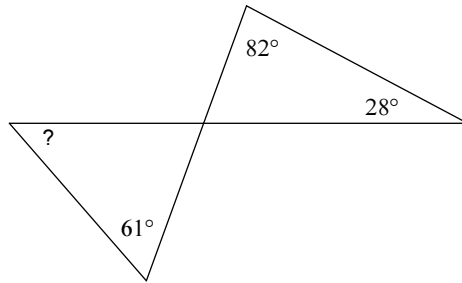

89)

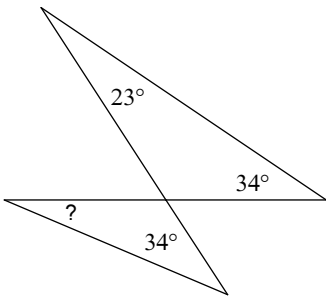

90)

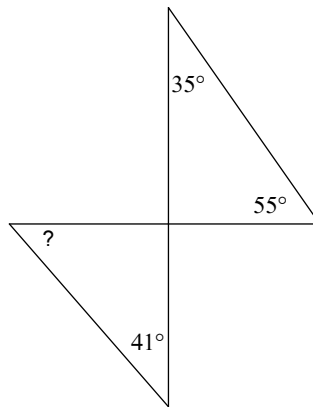

91)

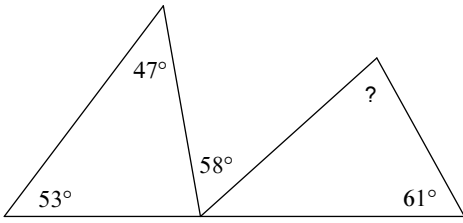

92)

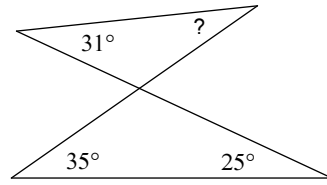

93)

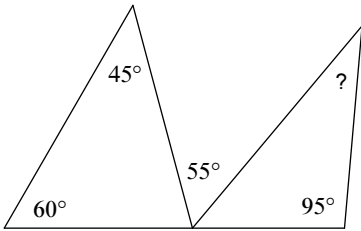

94)

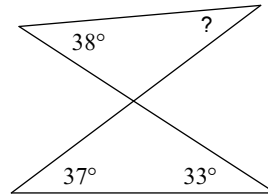

95)

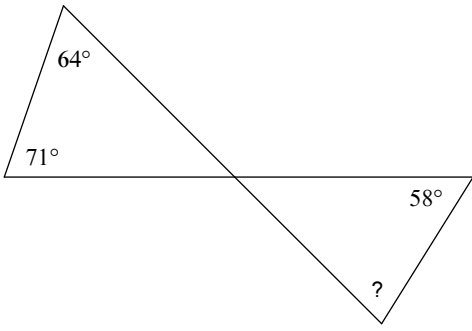

96)

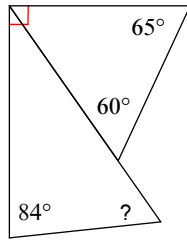

97)

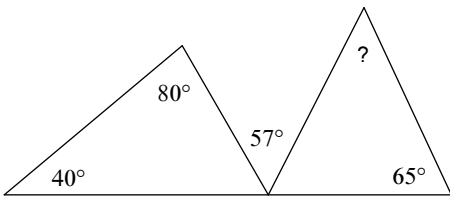

98)

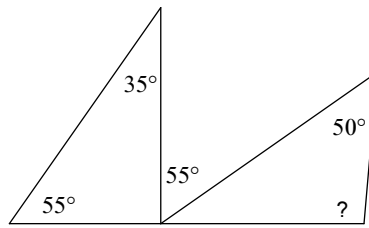

99)

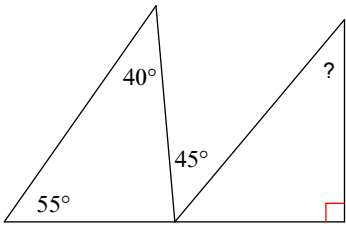

100)

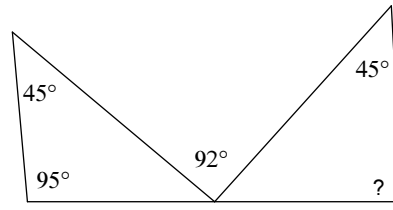

101)

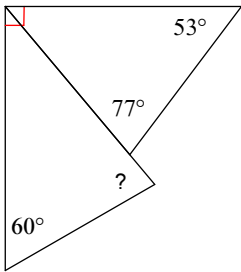

102)

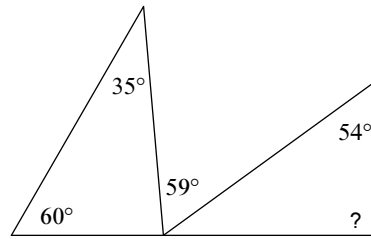

103)

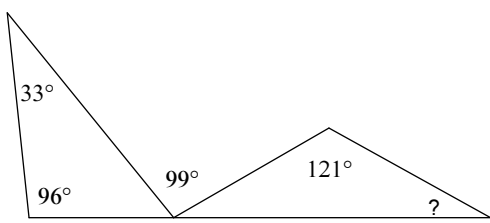

104)

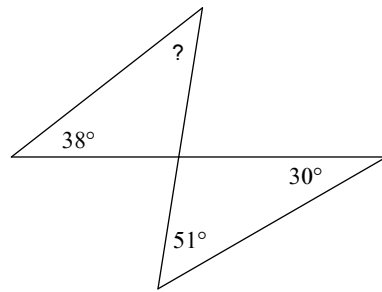

105)

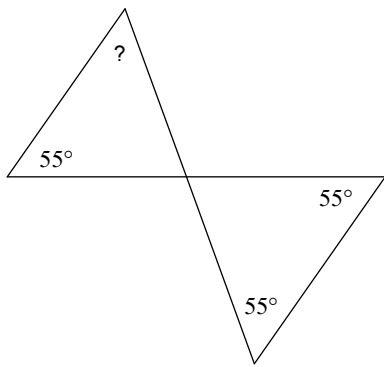

106)

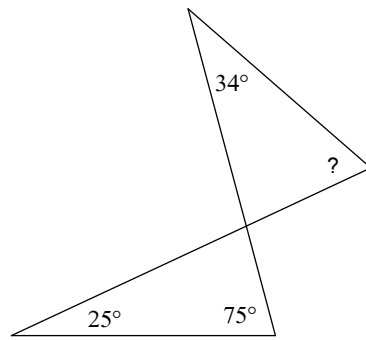

107)

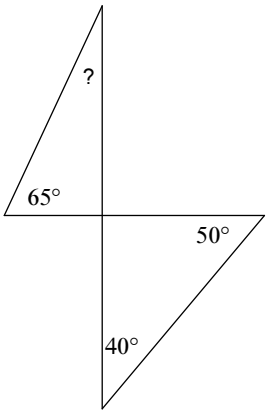

108)

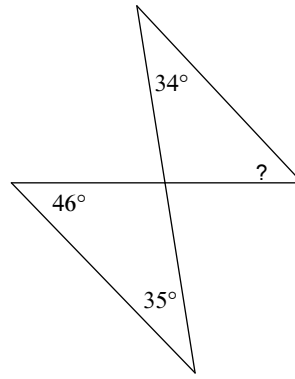

109)

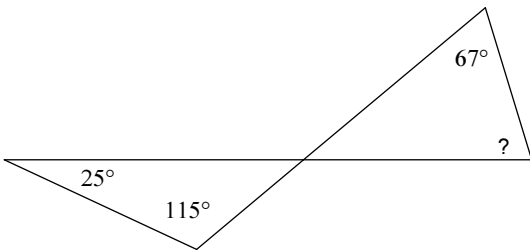

110)

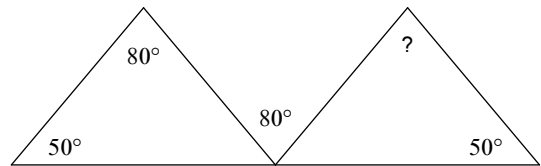

111)

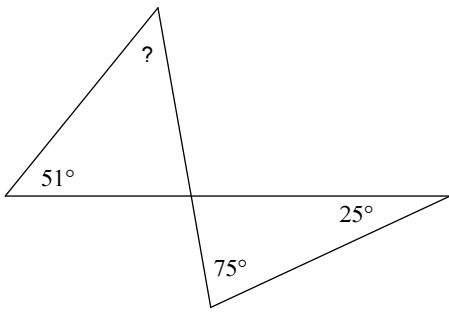

112)

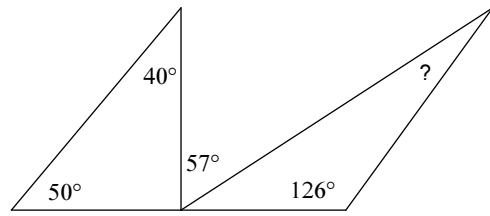

113)

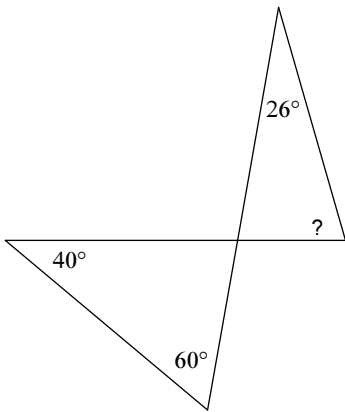

114)

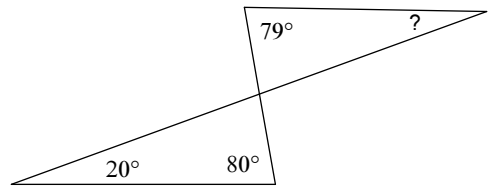

115)

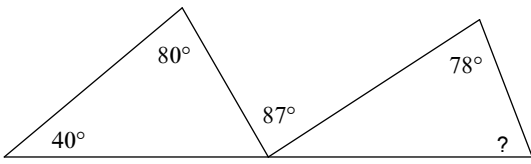

116)

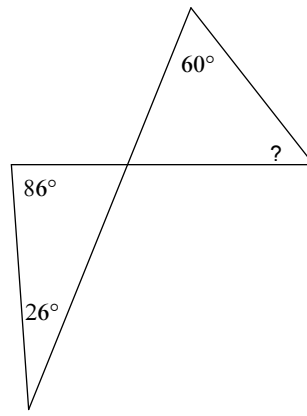

117)

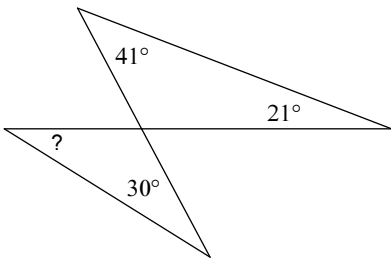

118)

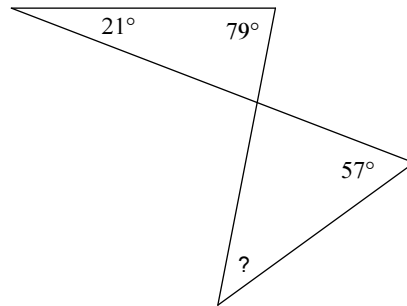

119)

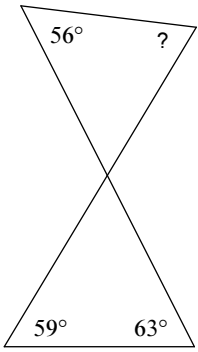

120)

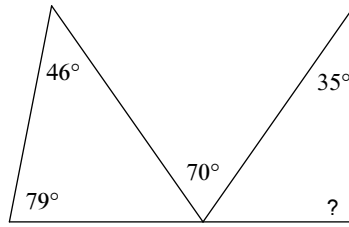

121)

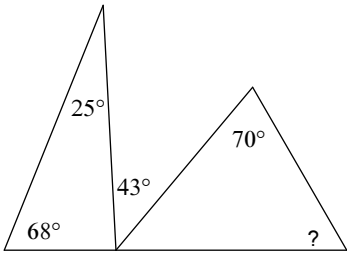

122)

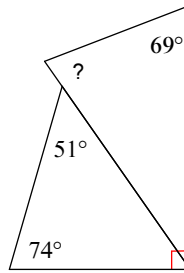

123)

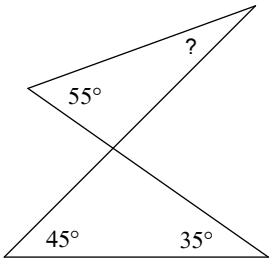

124)

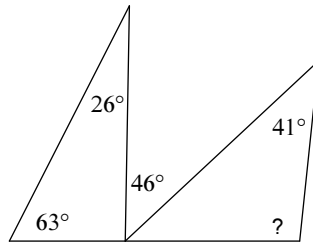

125)

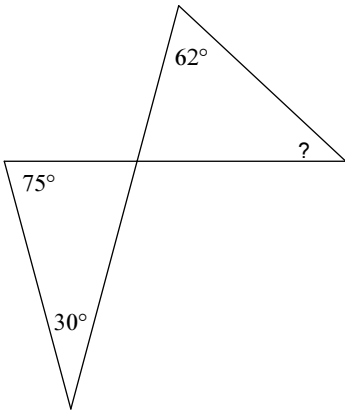

126)

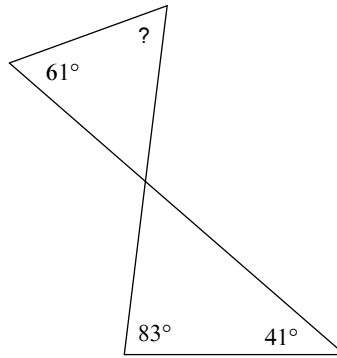

127)

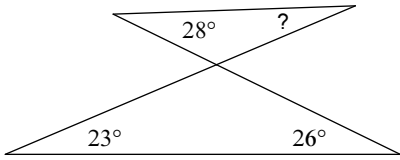

128)

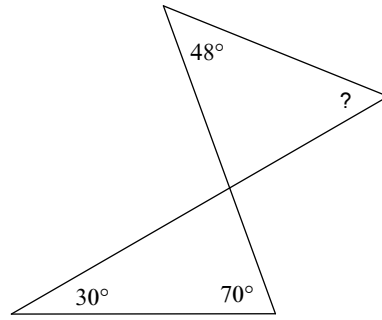

129)

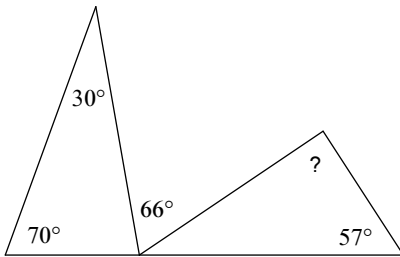

130)

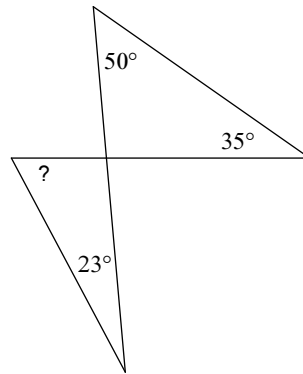

131)

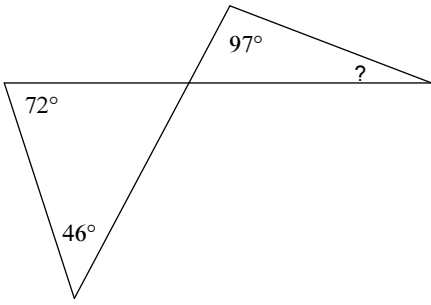

132)

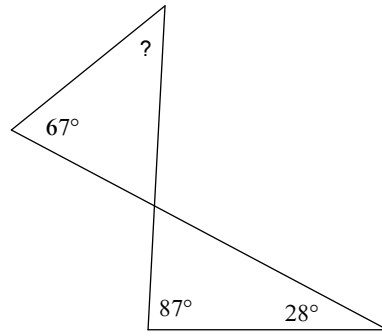

133)

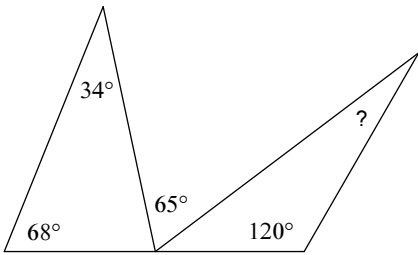

134)

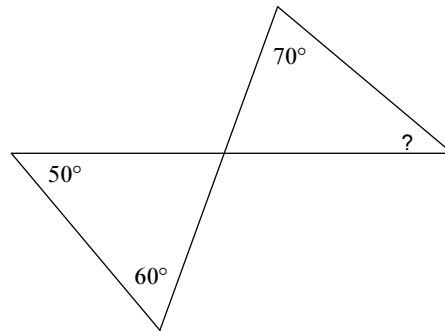

135)

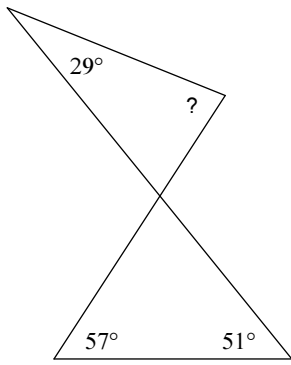

136)

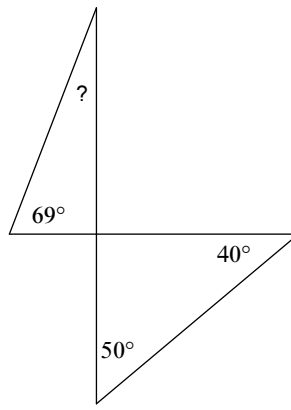

137)

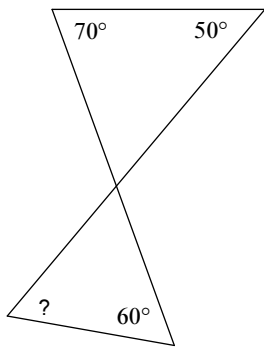

138)

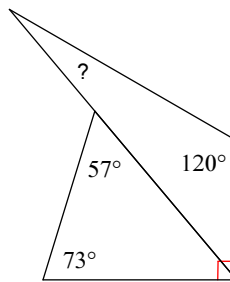

139)

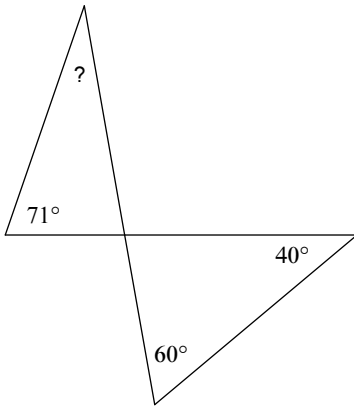

140)

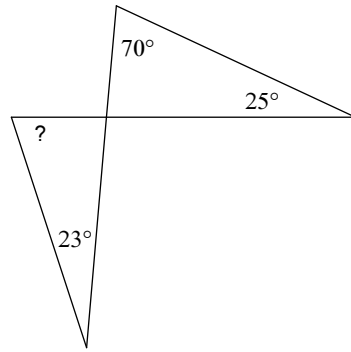

141)

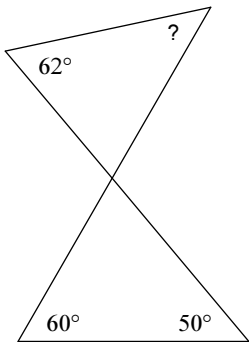

142)

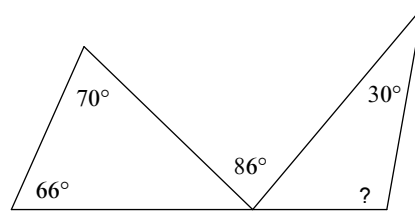

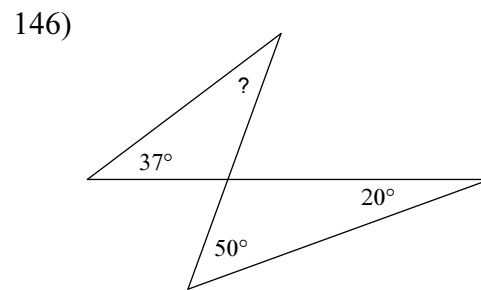
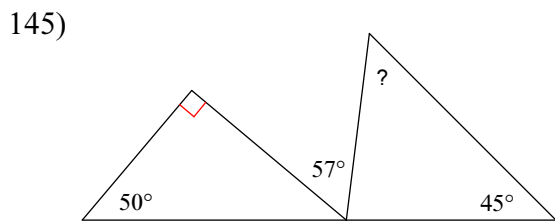
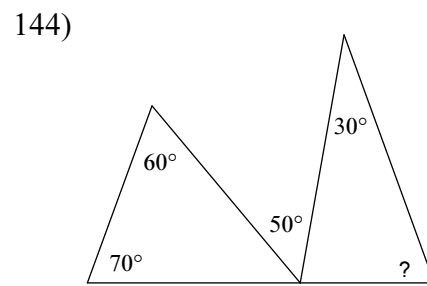
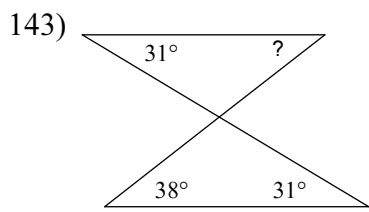

147)

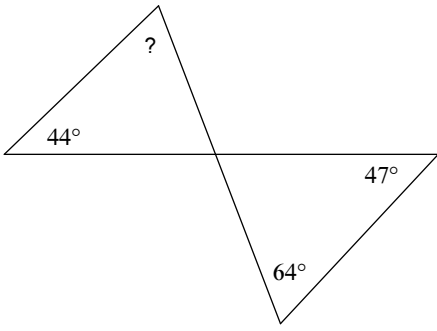

148)

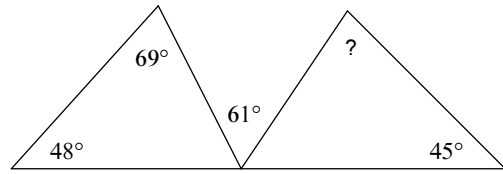

149)

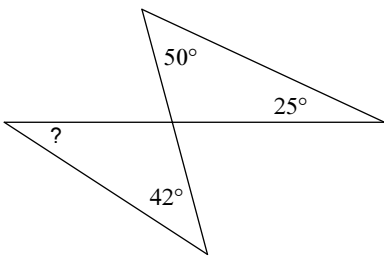

150)

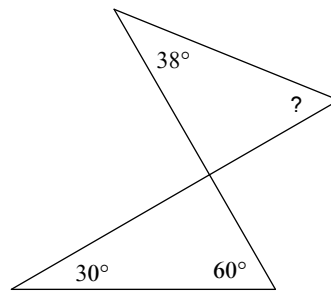

151)

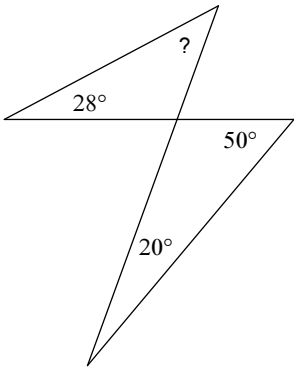

152)

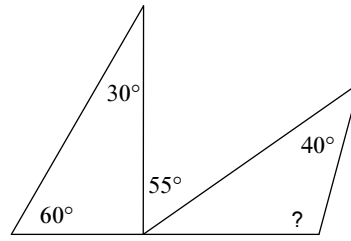

153)

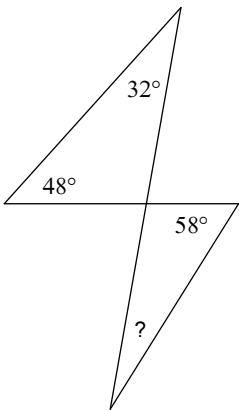

154)

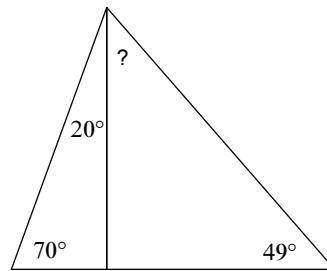

155)

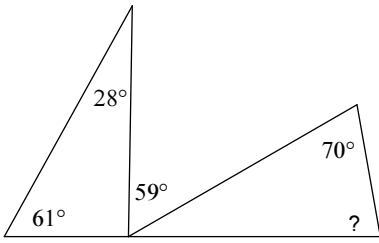

156)

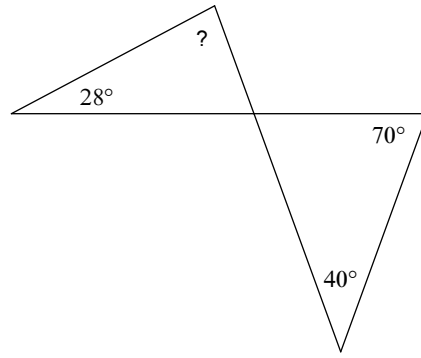

157)

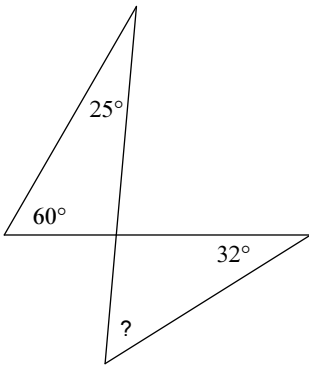

158)

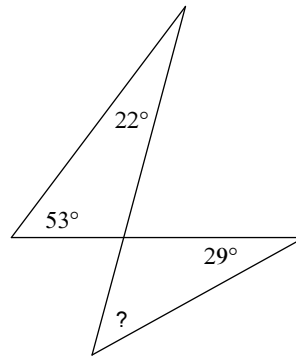

159)

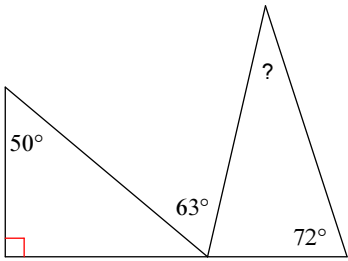

160)

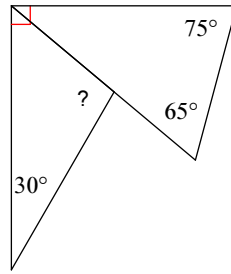

161)

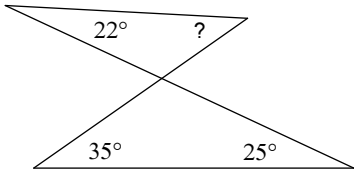

162)

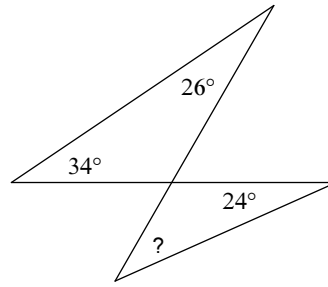

163)

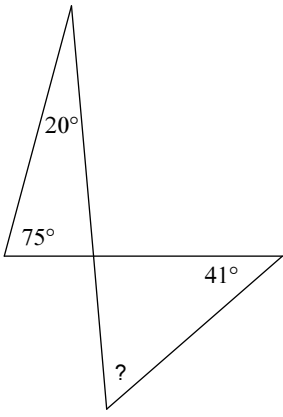

164)

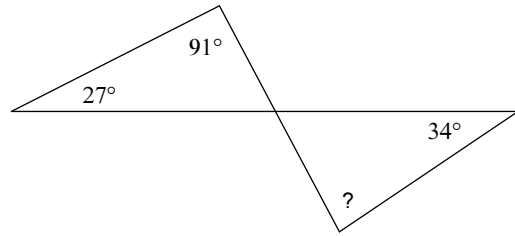

165)

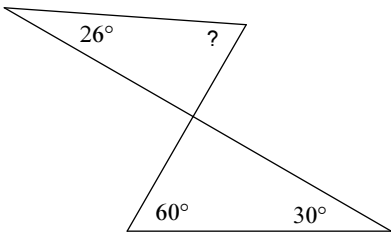

166)

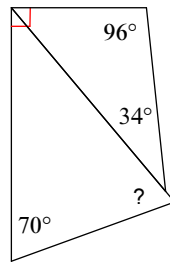

167)

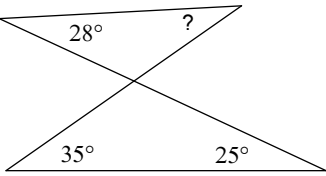

168)

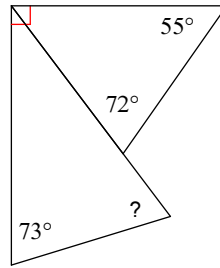

169)

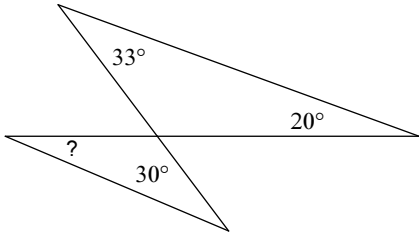

170)

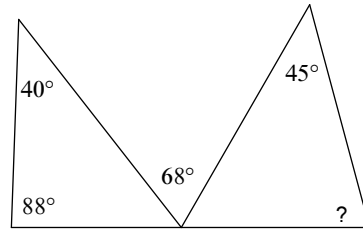

171)

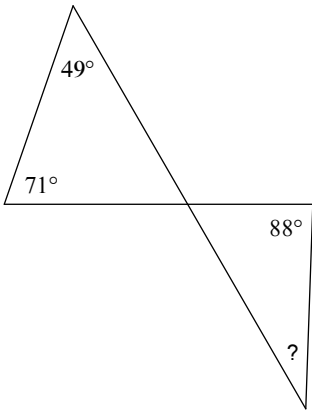

172)

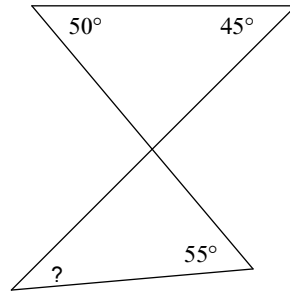

173)

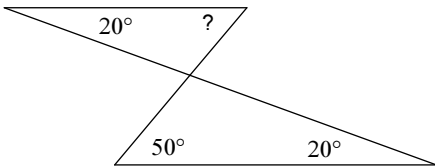

174)

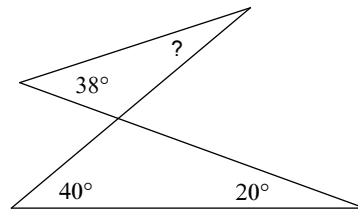

175)

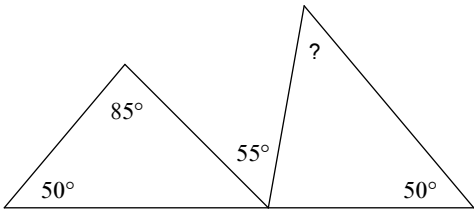

176)

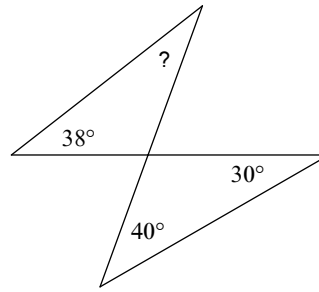

177)

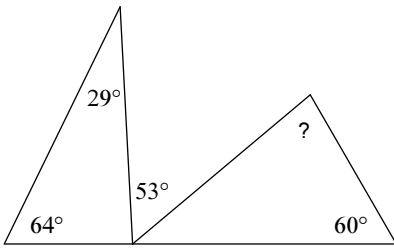

178)

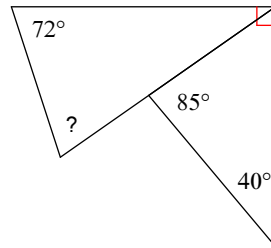

179)

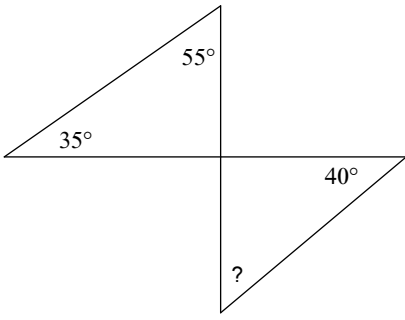

180)

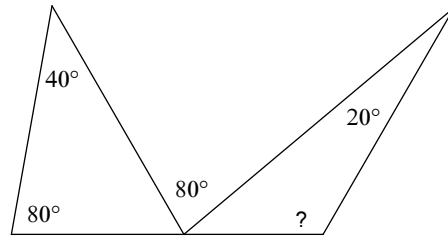

181)

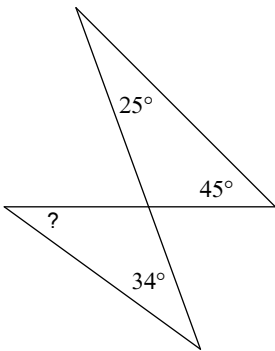

182)

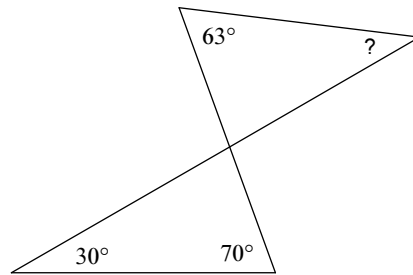

183)

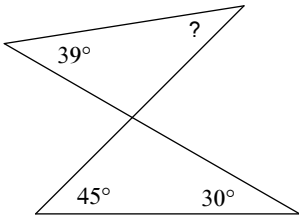

184)

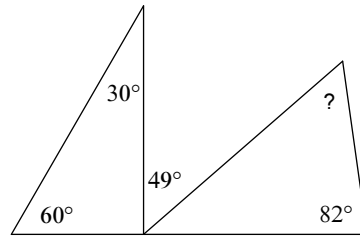

185)

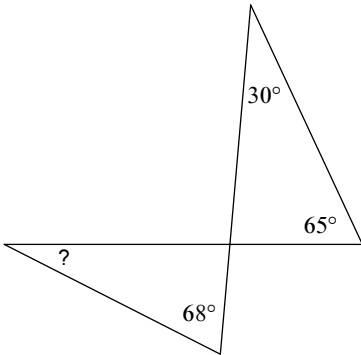

186)

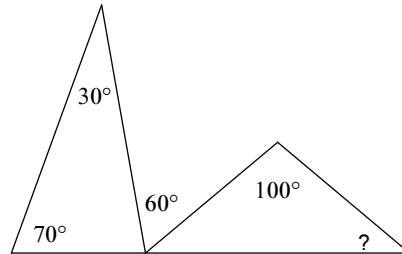

187)

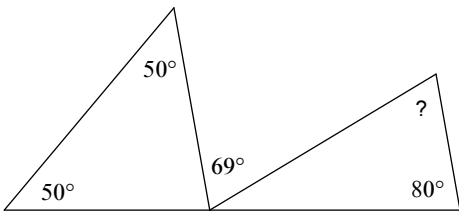

188)

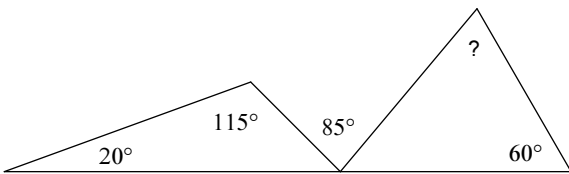

189)

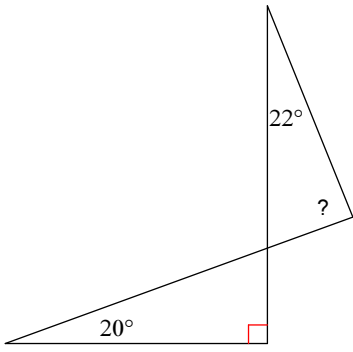

190)

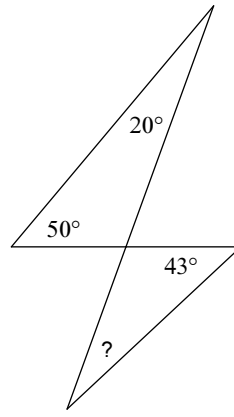

191)

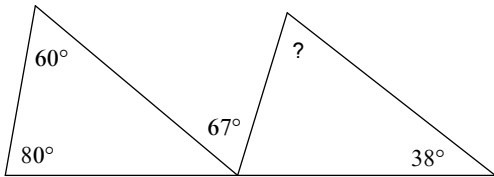

192)

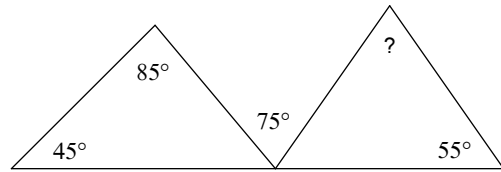

193)

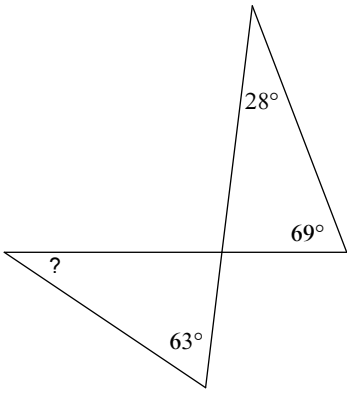

194)

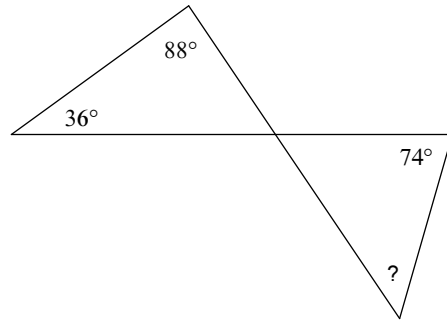

195)

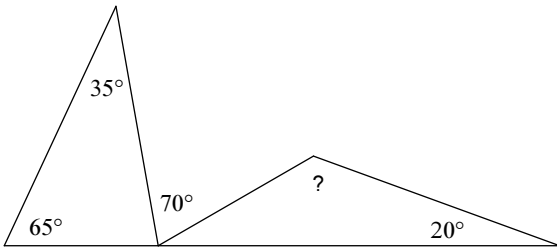

196)

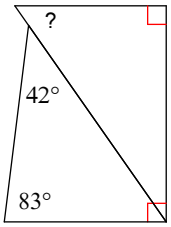

197)

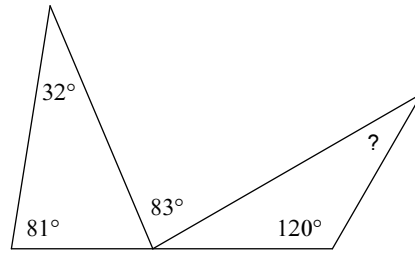

198)

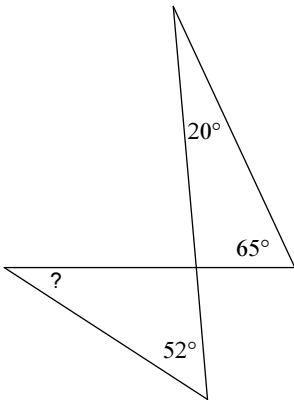

199)

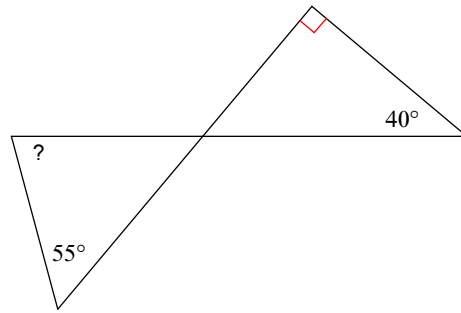

200)

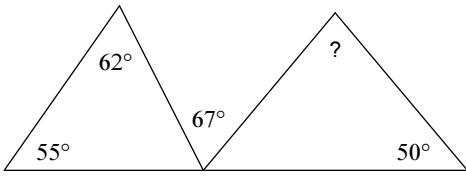

201)

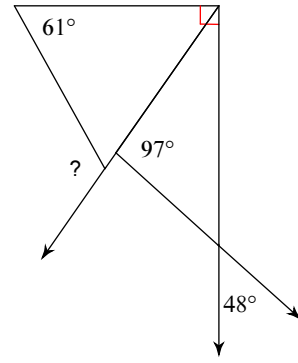

202)

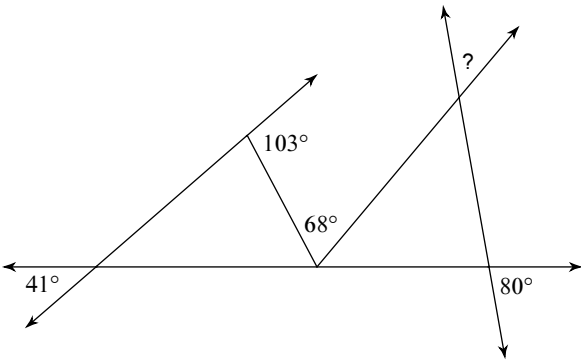

203)

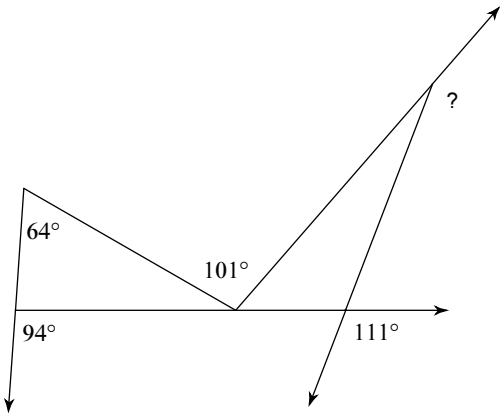

204)

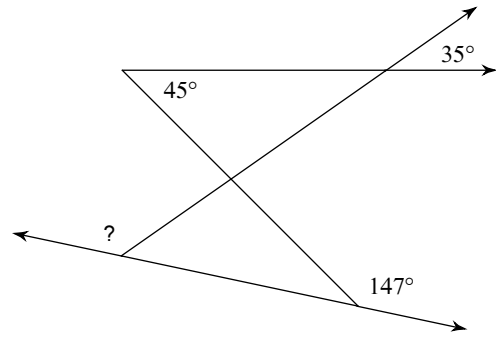

205)

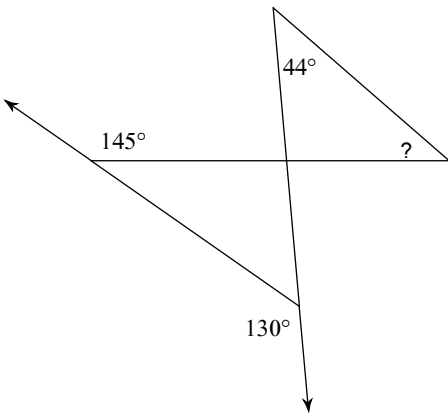

206)

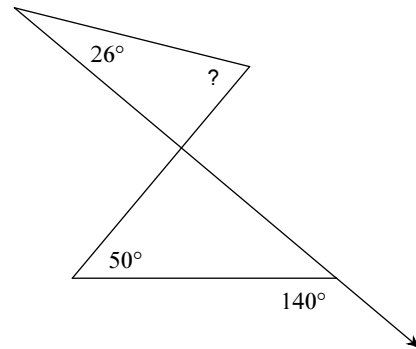

207)

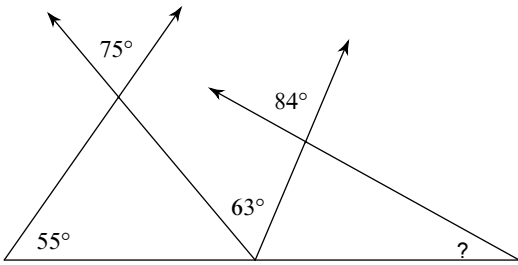

208)

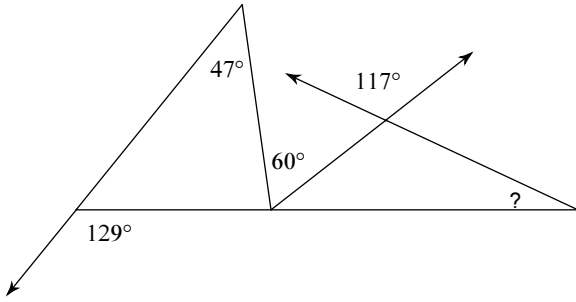

209)

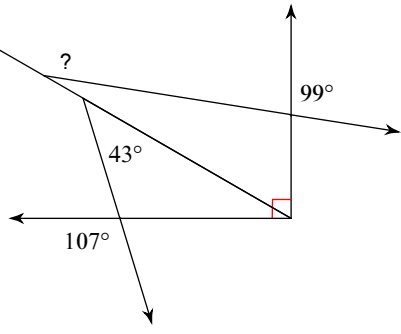

210)

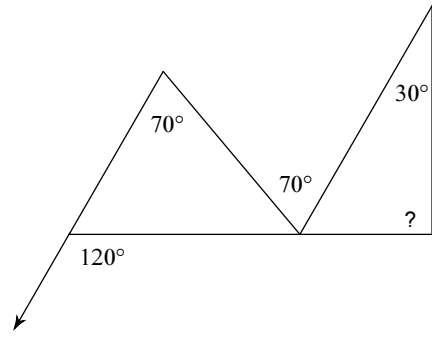

211)

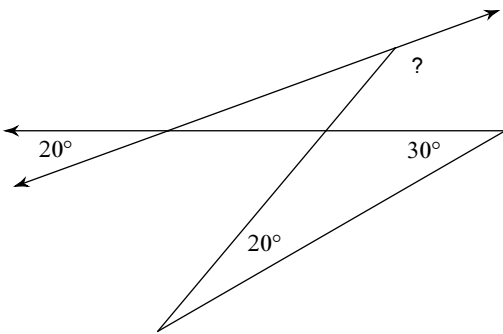

212)

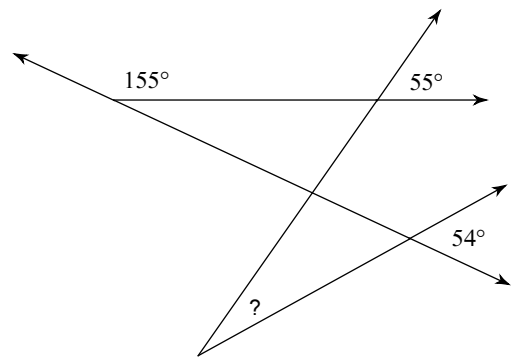

213)

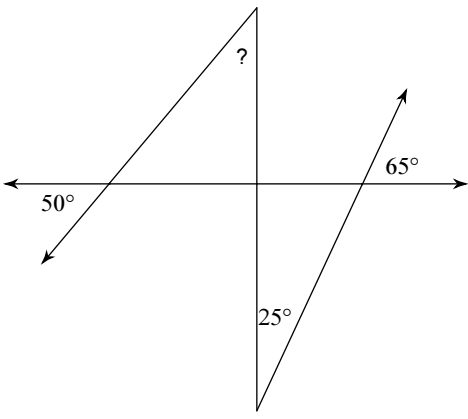

214)

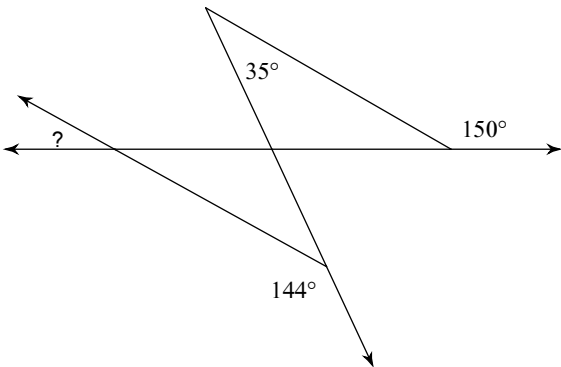

215)

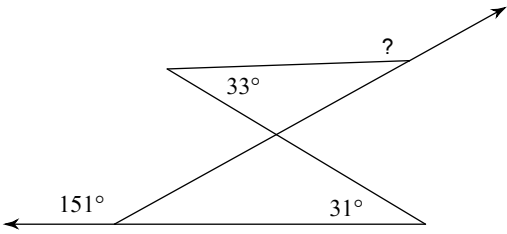

216)

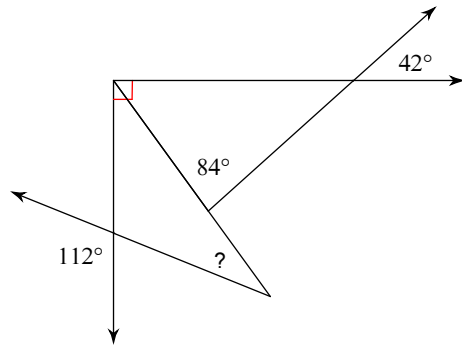

217)

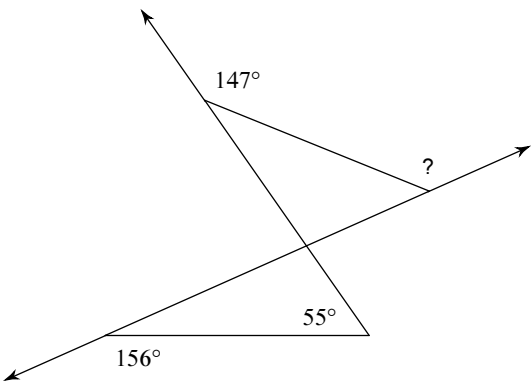

218)

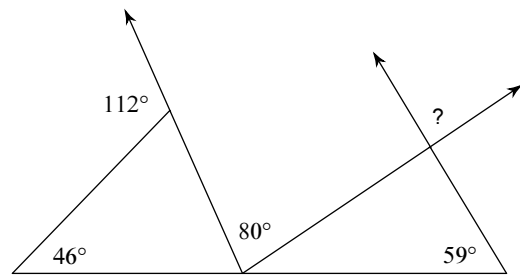

219)

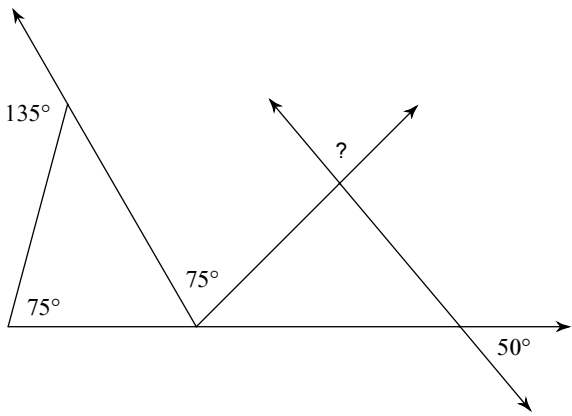

220)

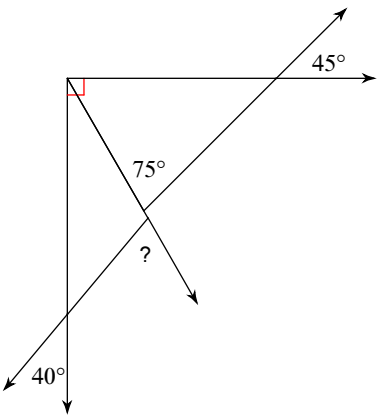

221)

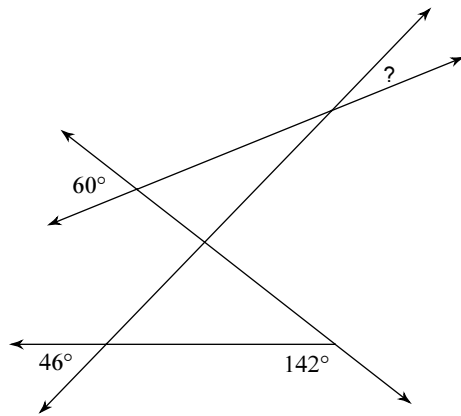

222)

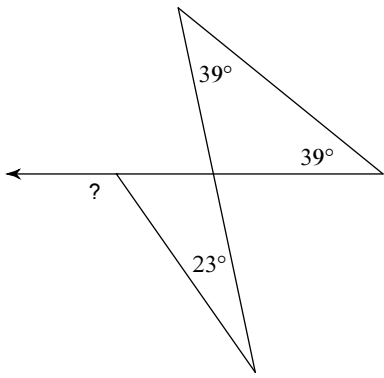

223)

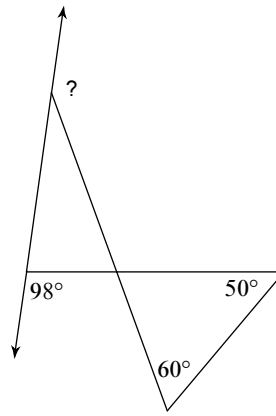

224)

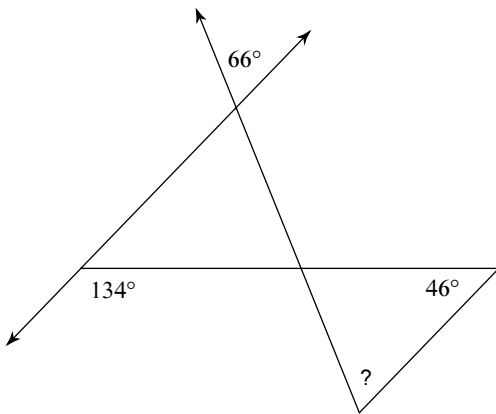

225)

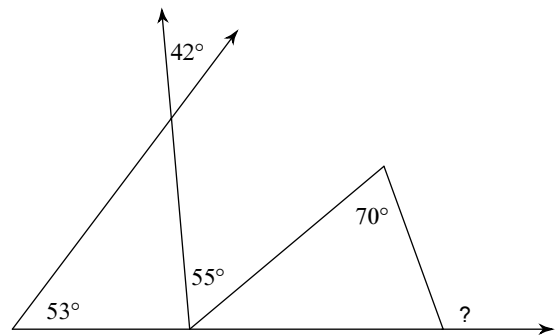

226)

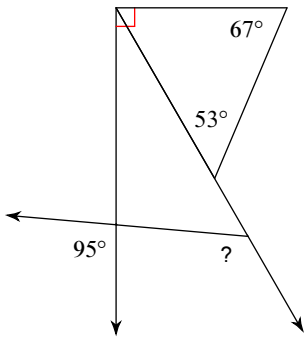

227)

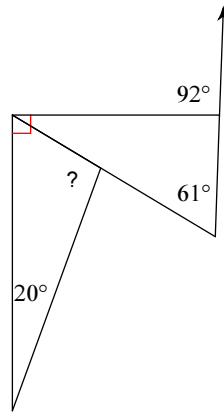

228)

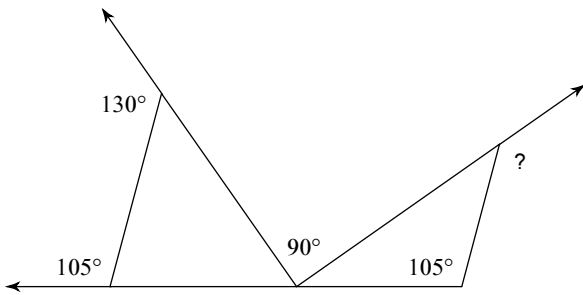

229)

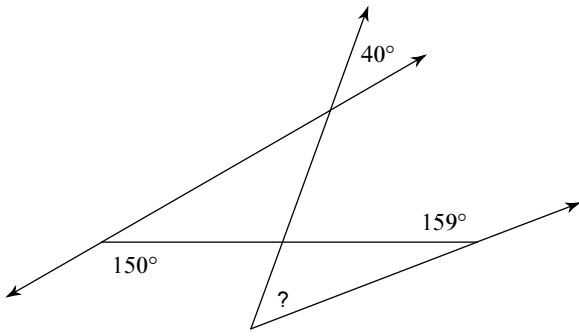

230)

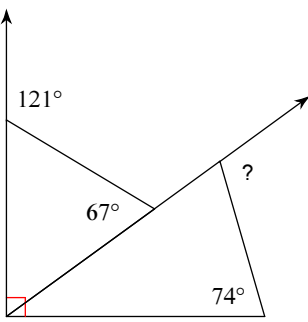

231)

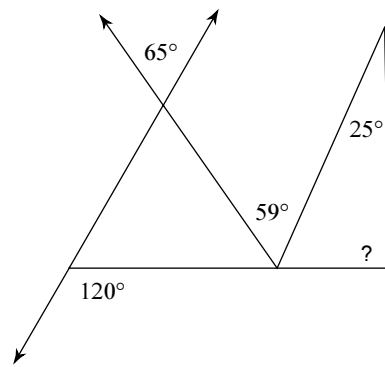

232)

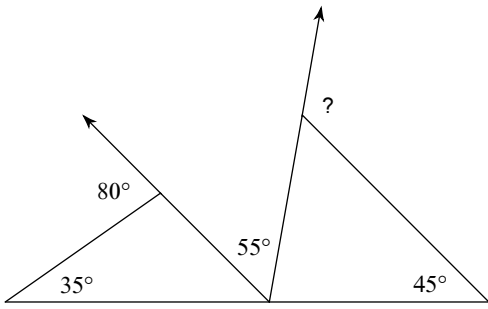

233)

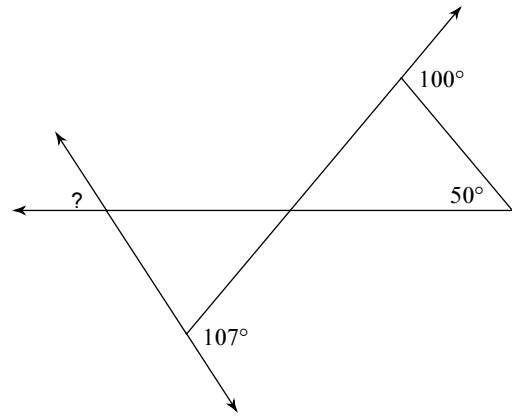

234)

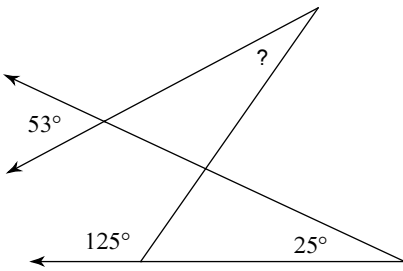

235)

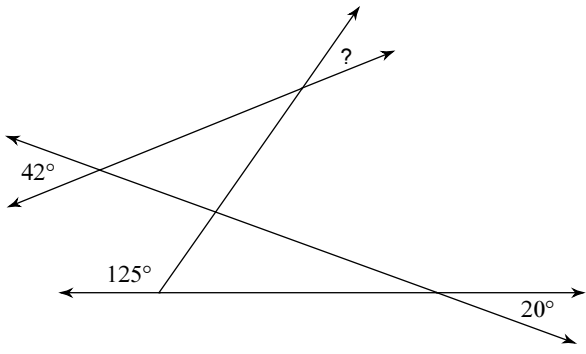

236)

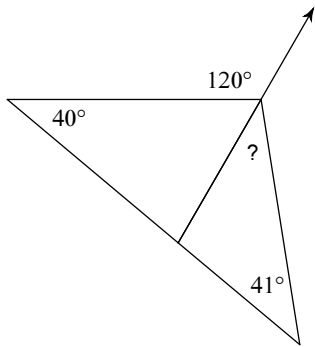

237)

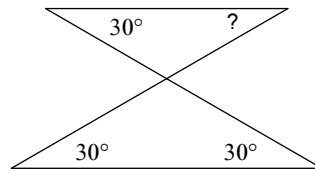

238)

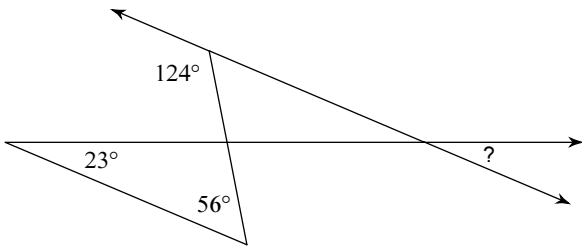

239)

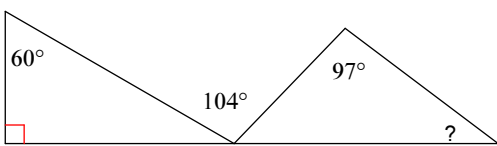

240)

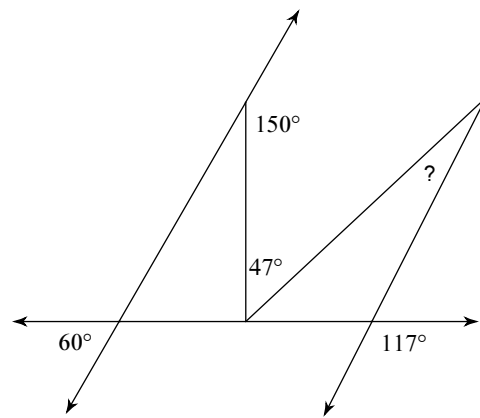

241)

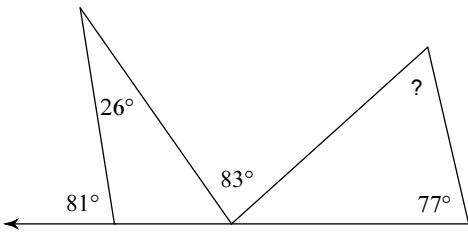

242)

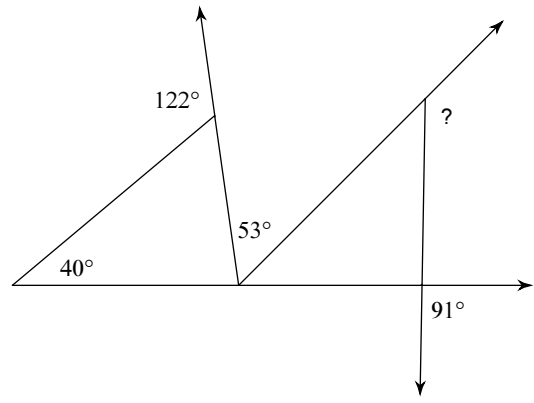

243)

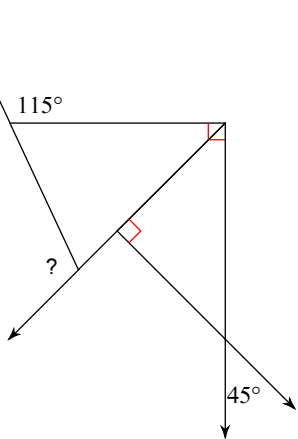

244)

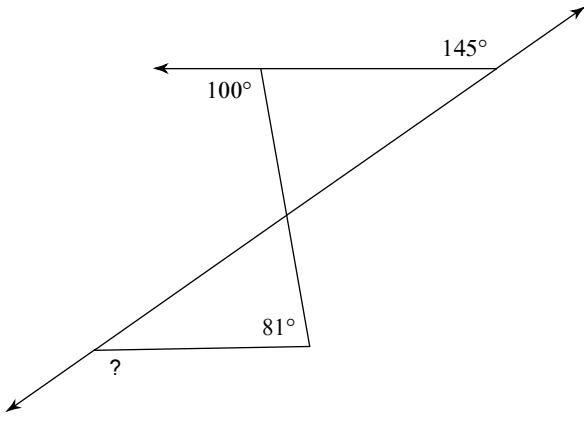

245)

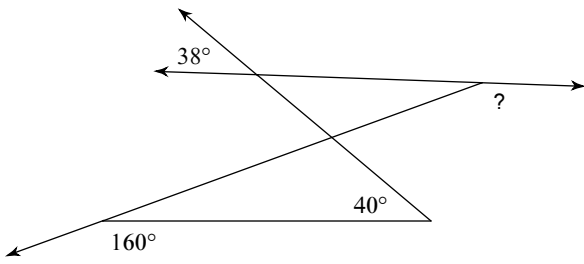

246)

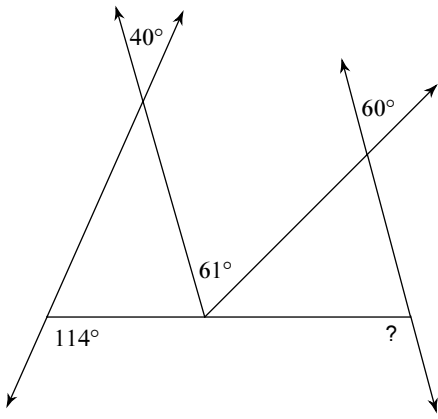

247)

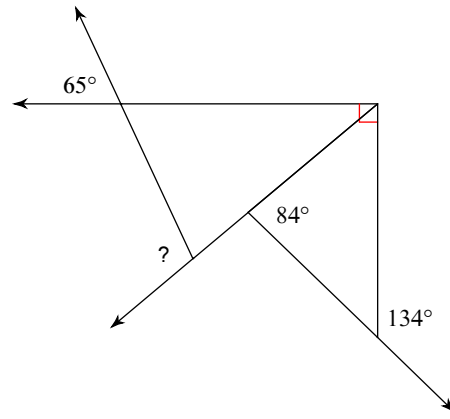

248)

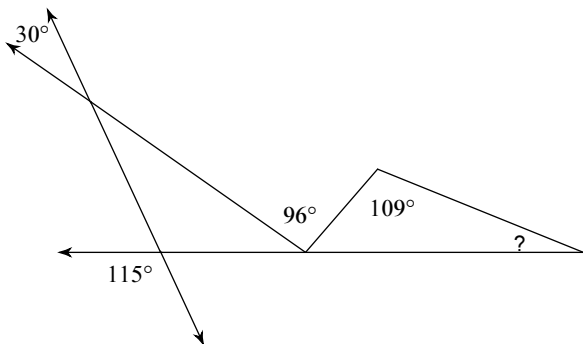

249)

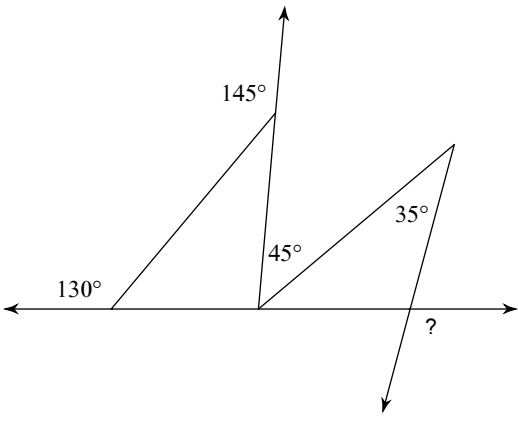

250)

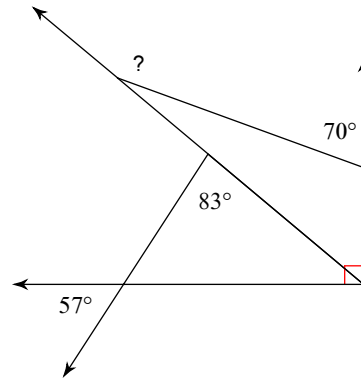

251)

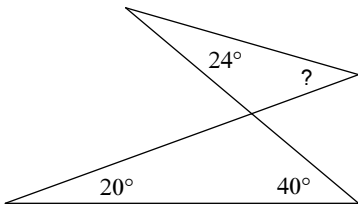

252)

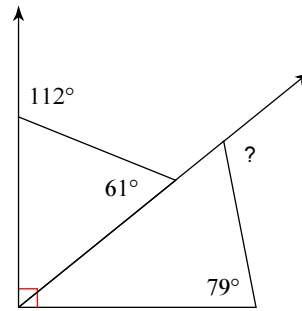

253)

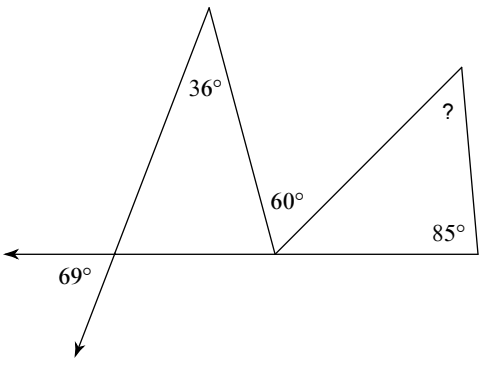

254)

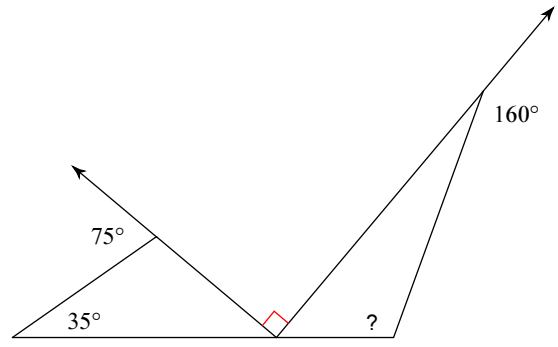

255)

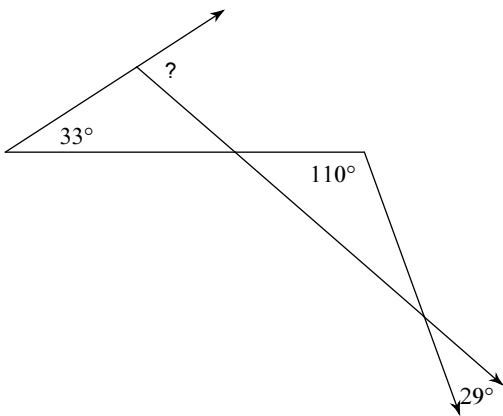

256)

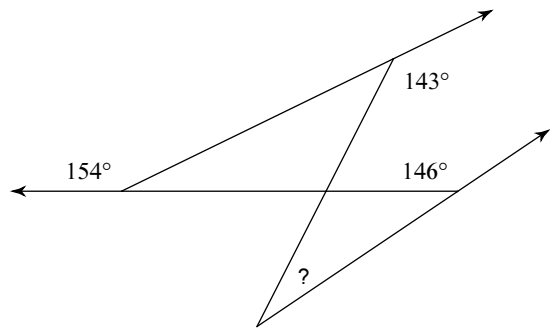

257)

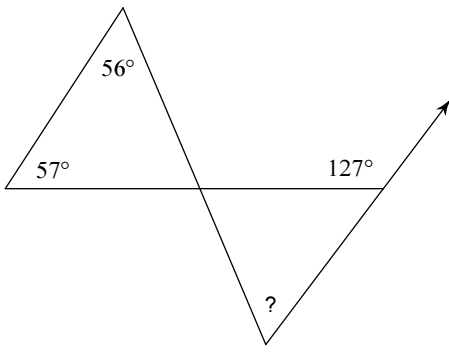

258)

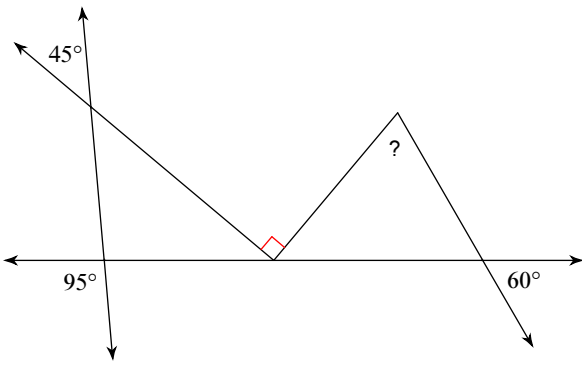

259)

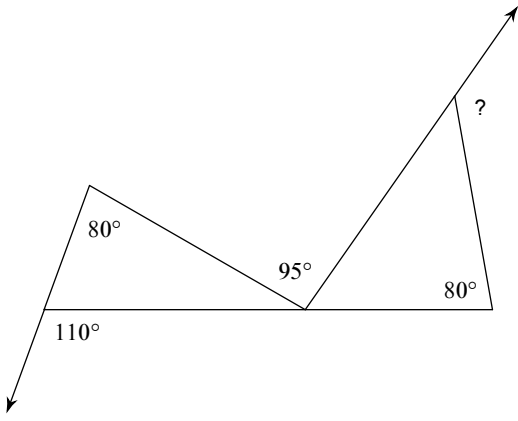

260)

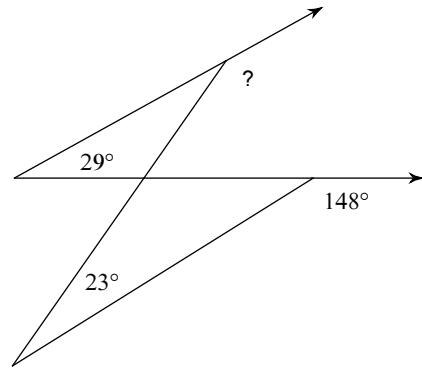

261)

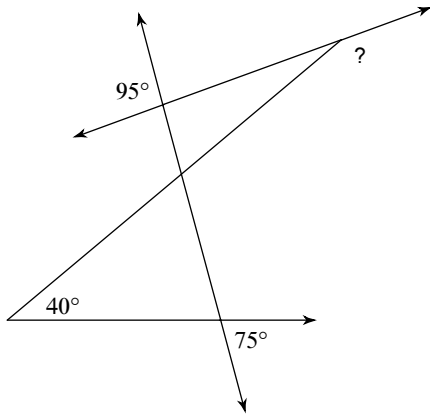

262)

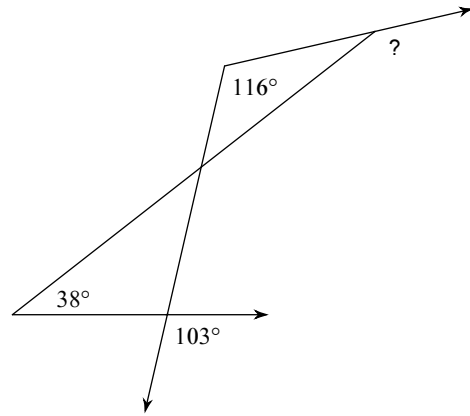

263)

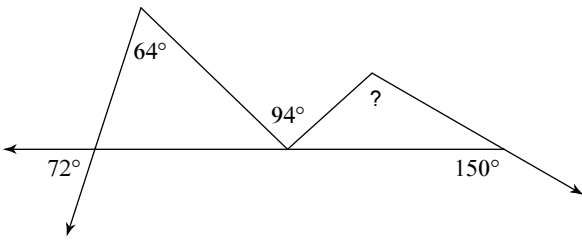

264)

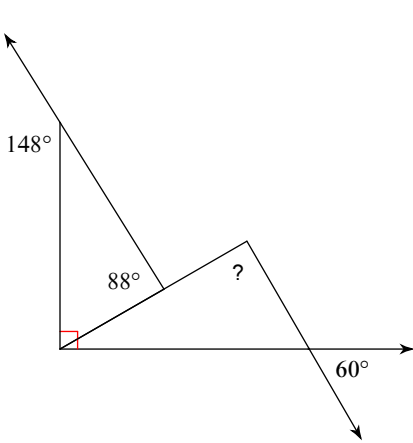

265)

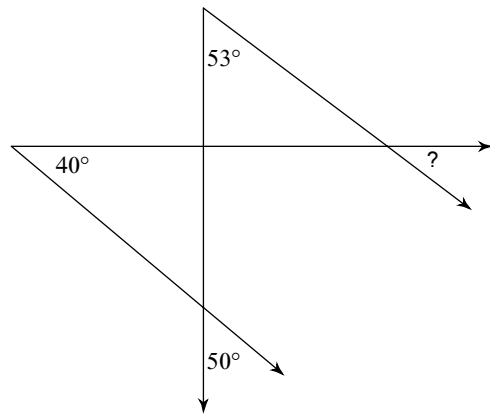

266)

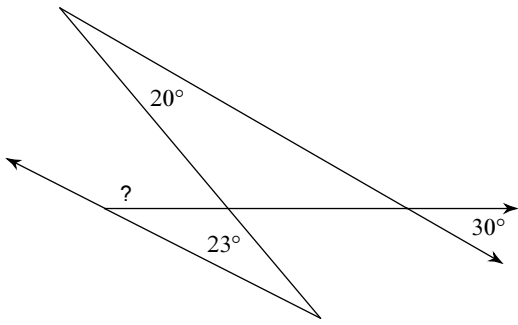

267)

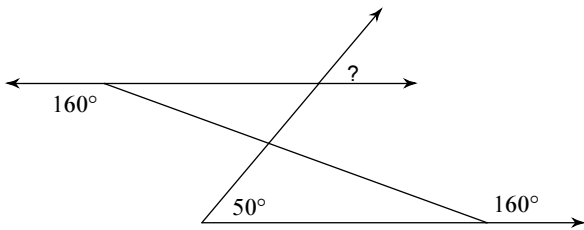

268)

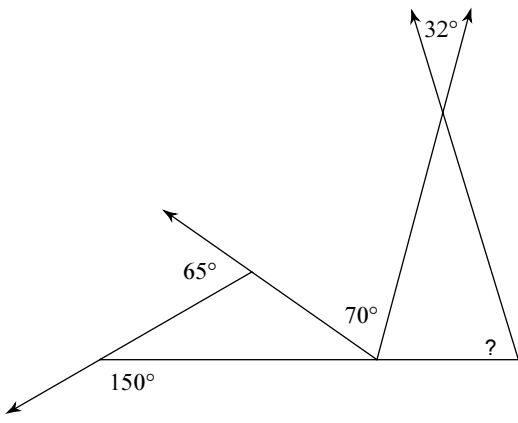

269)

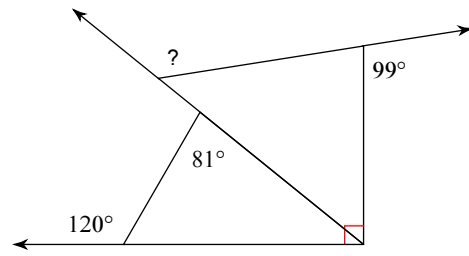

270)

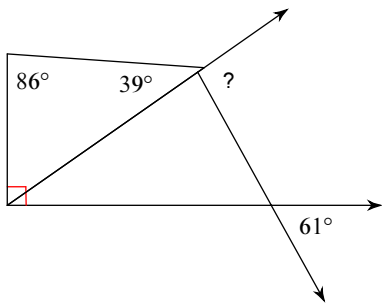

271)

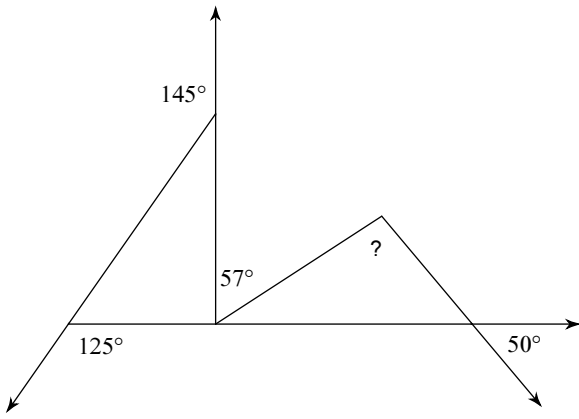

272)

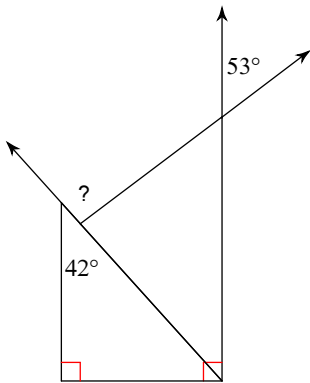

273)

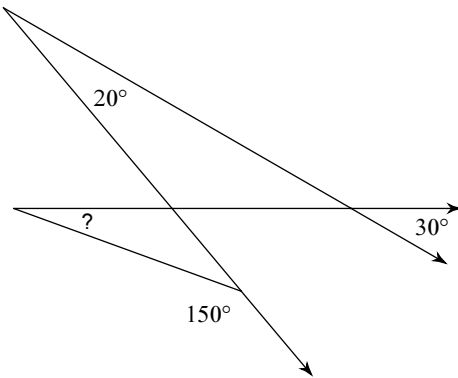

274)

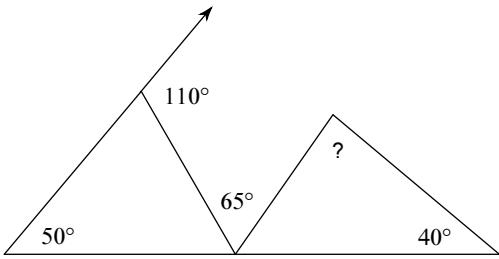

275)

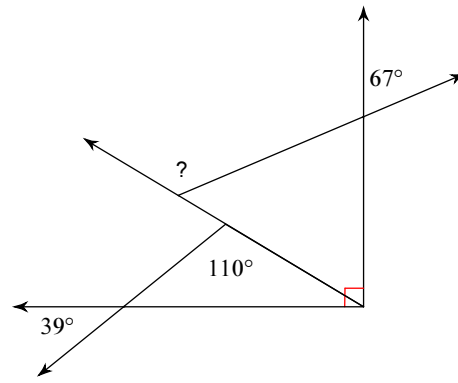

276)

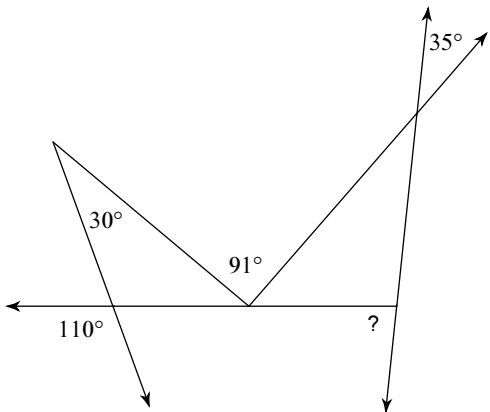

277)

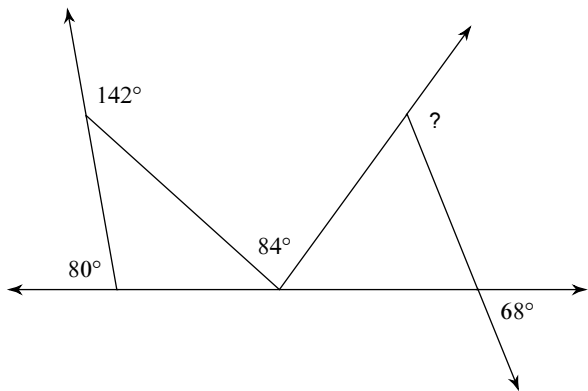

278)

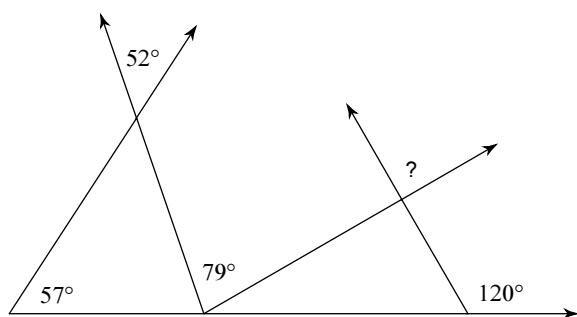

279)

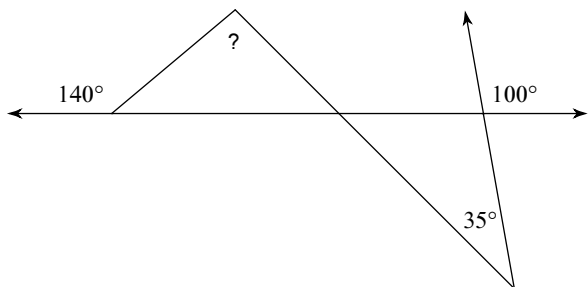

280)

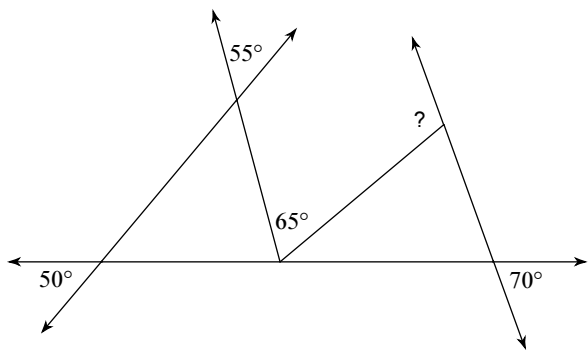

281)

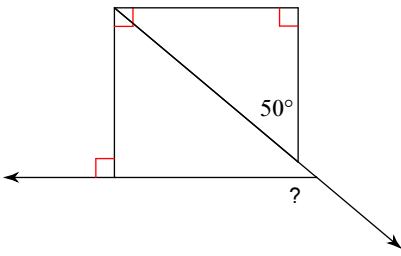

282)

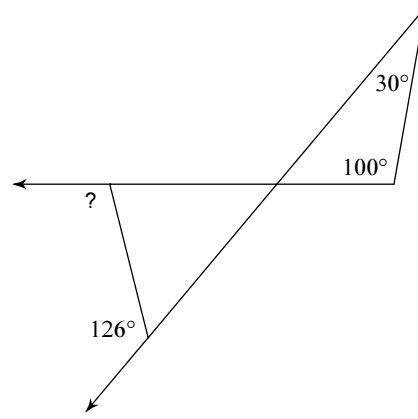

283)

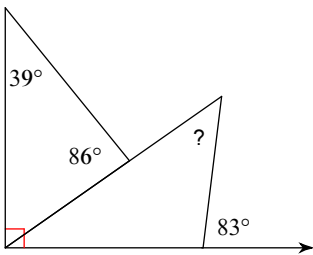

284)

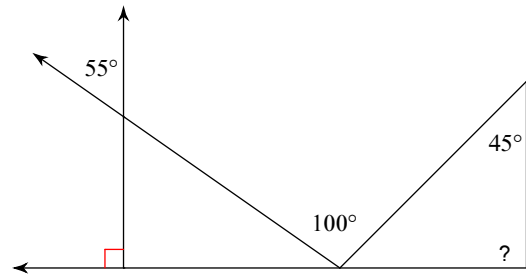

285)

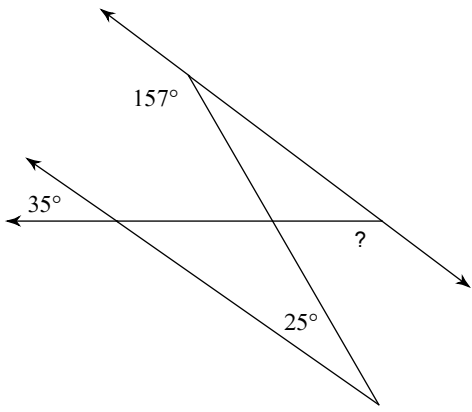

286)

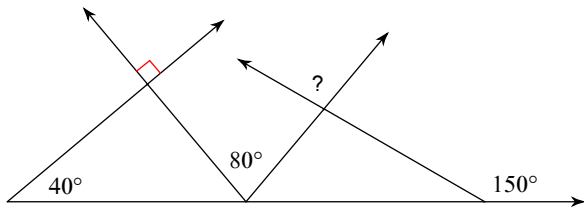

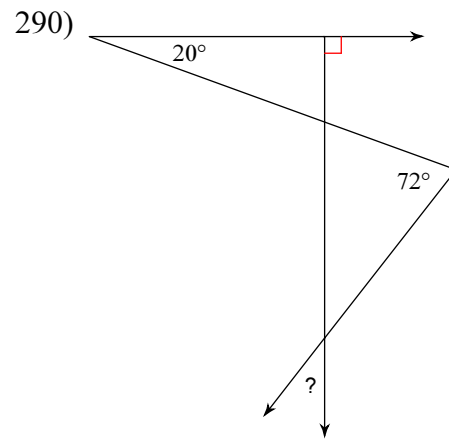
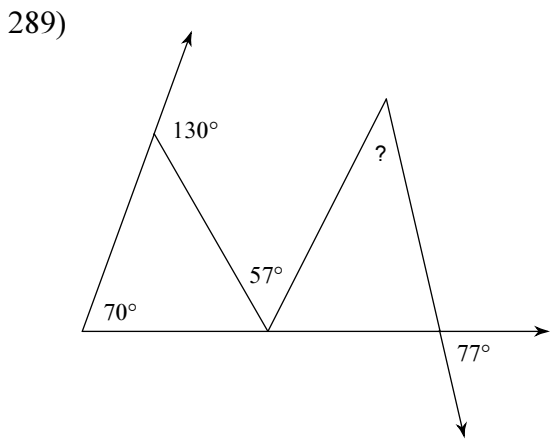
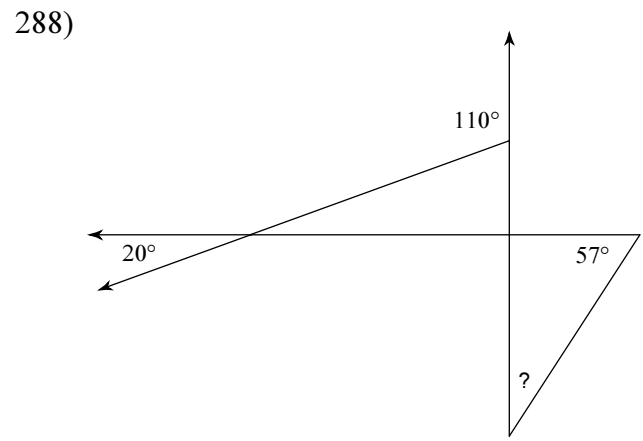
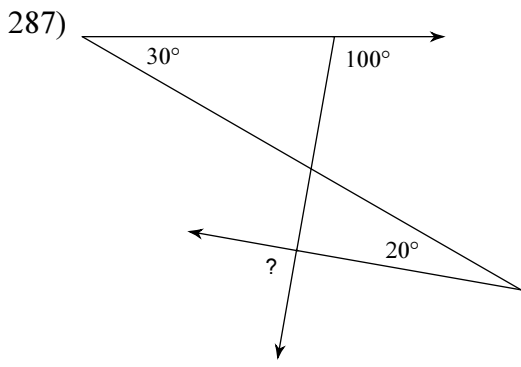

291)

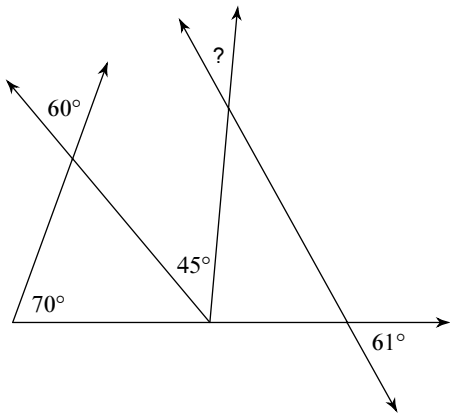

292)

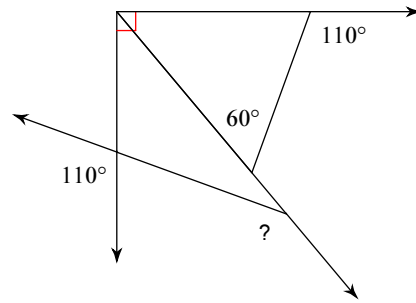

293)

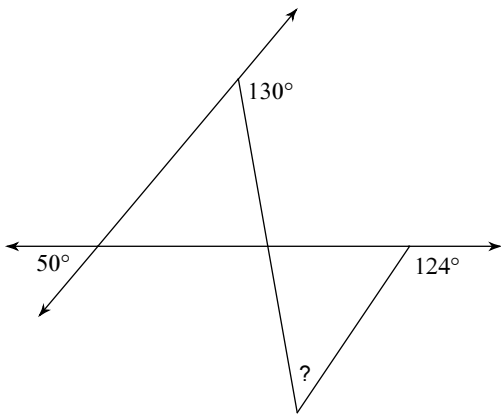

294)

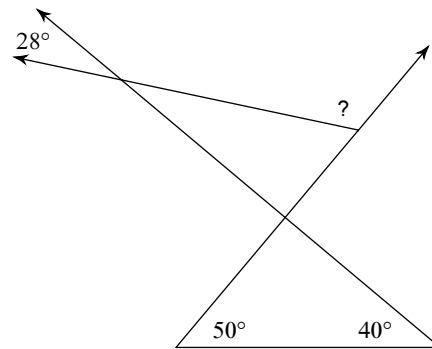

295)

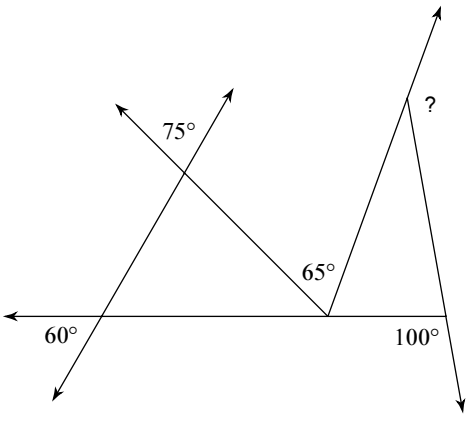

296)

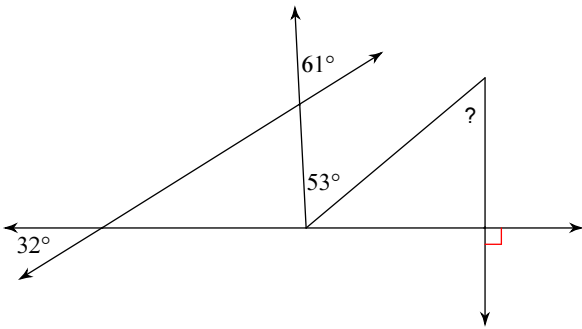

297)

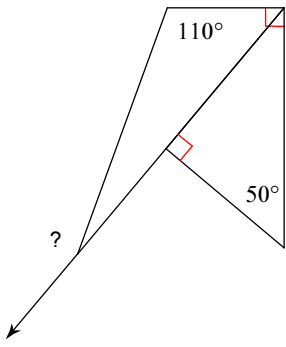

298)

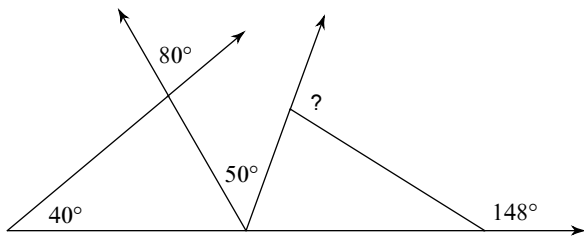

299)

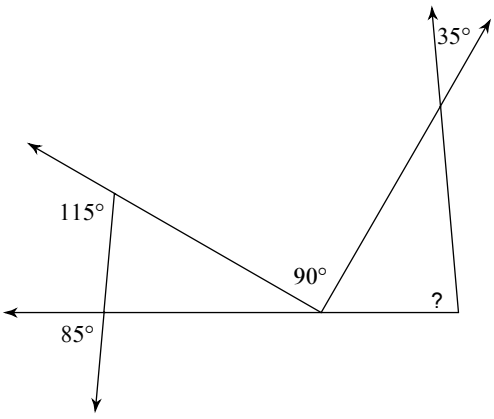

300)

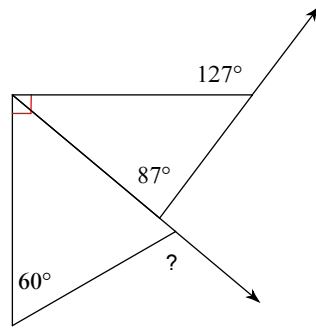

301)

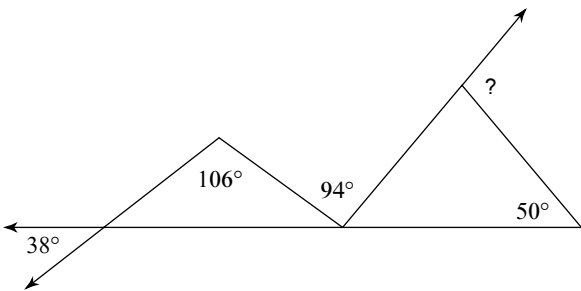

302)

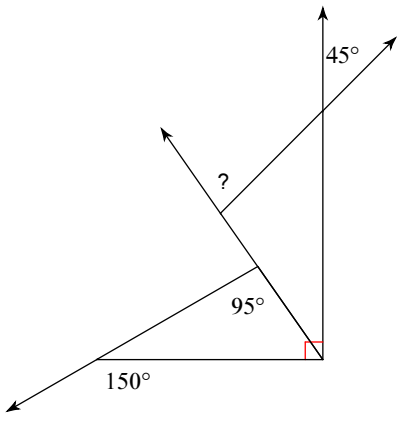

303)

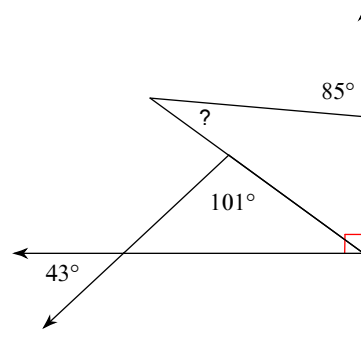

304)

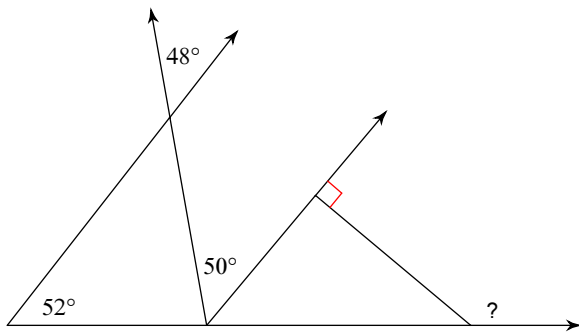

305)

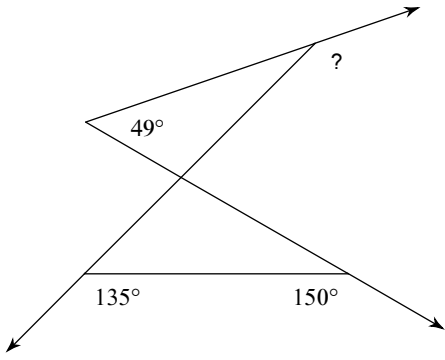

306)

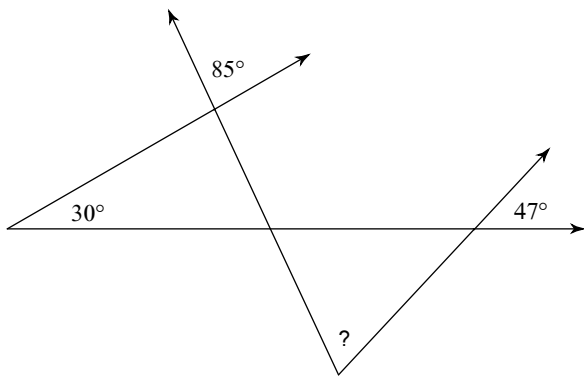

307)

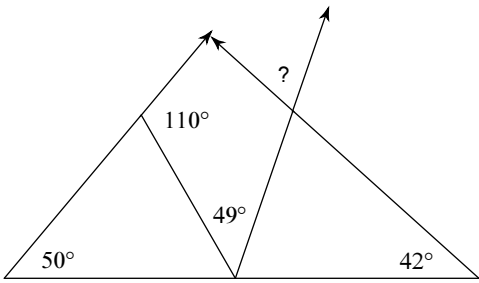

308)

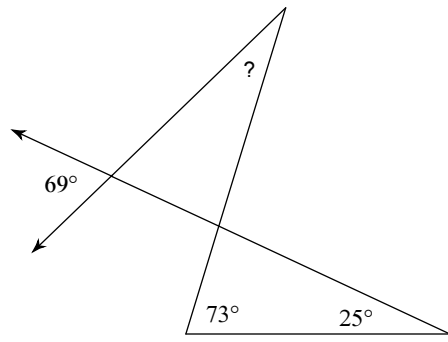

309)

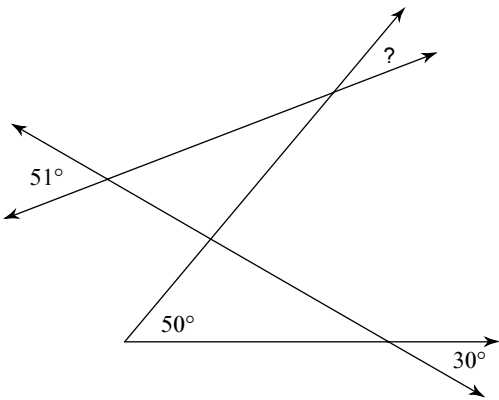

310)

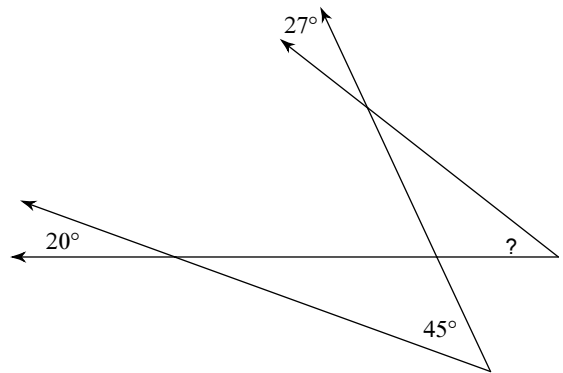

311)

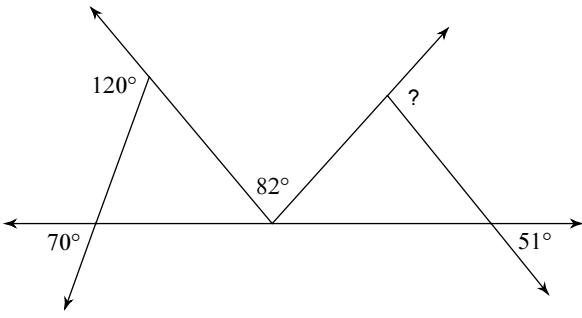

312)

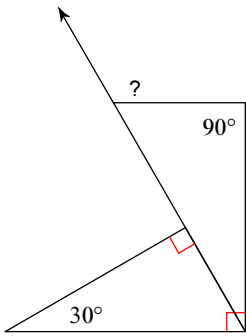

313)

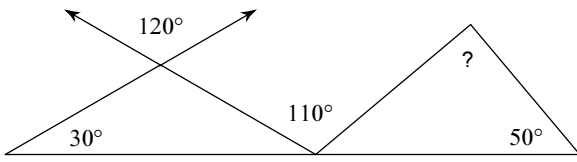

314)

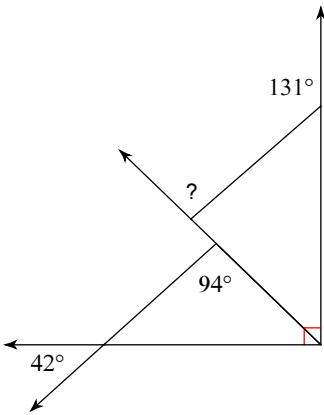

315)

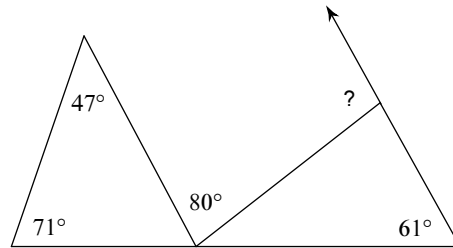

316)

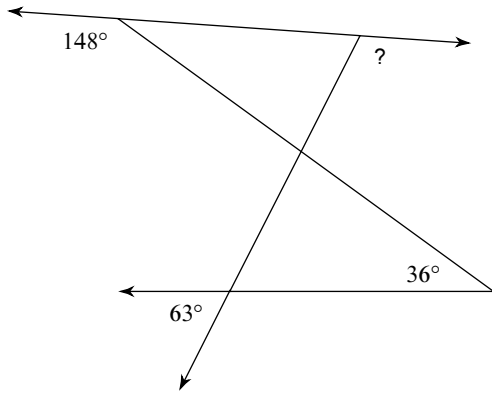

317)

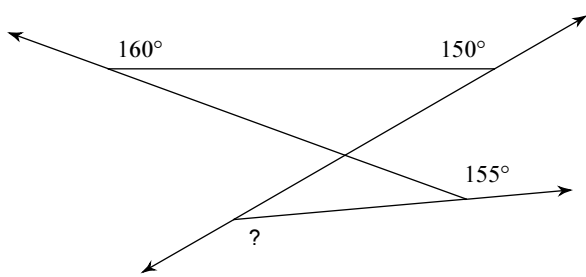

318)

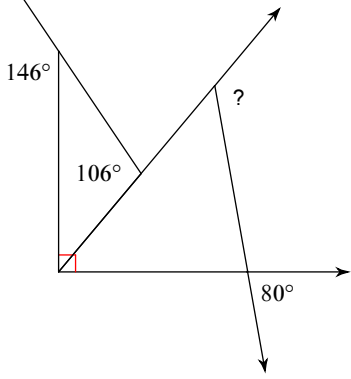

319)

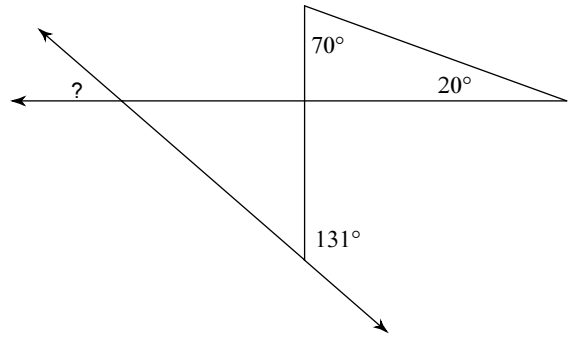

320)

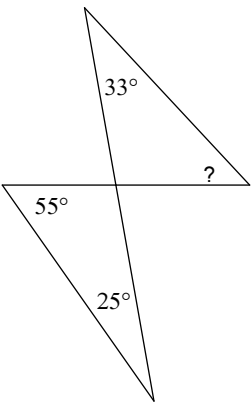

321)

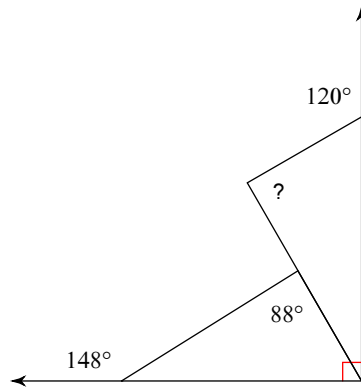

322)

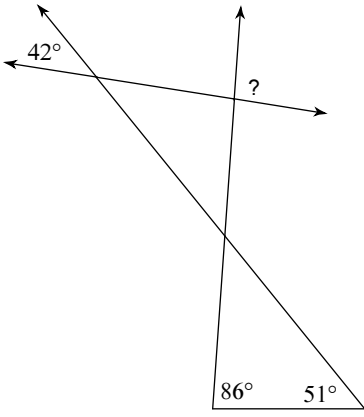

323)

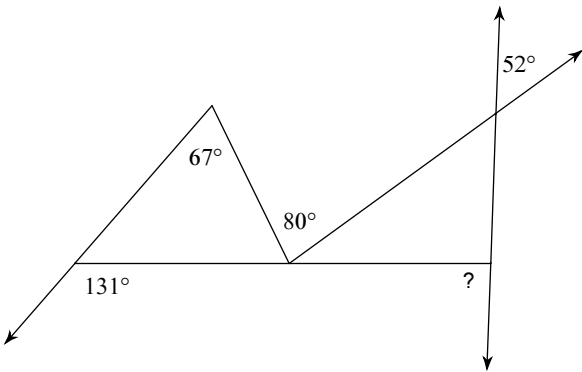

324)

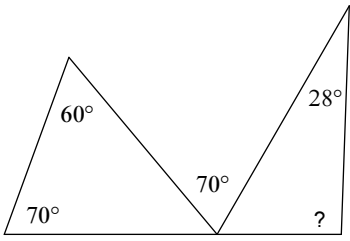

325)

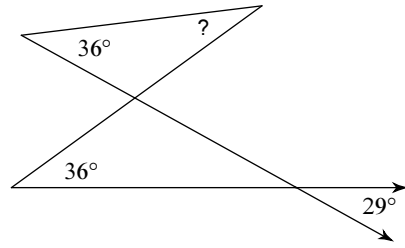

326)

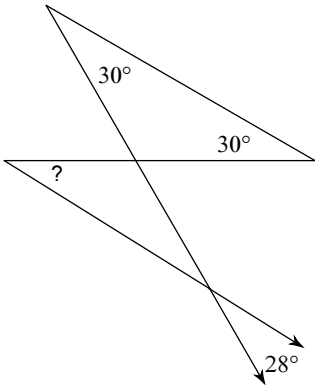

327)

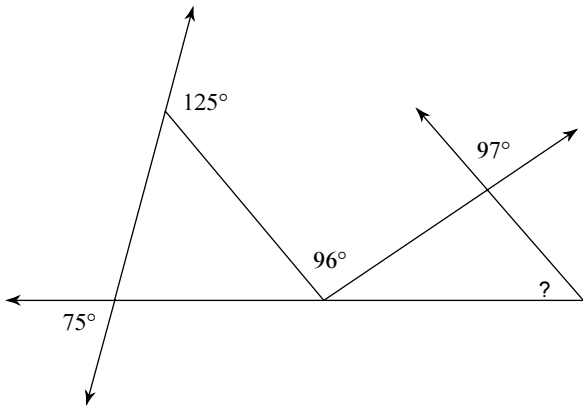

328)

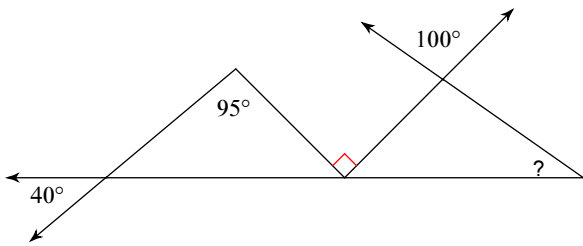

329)

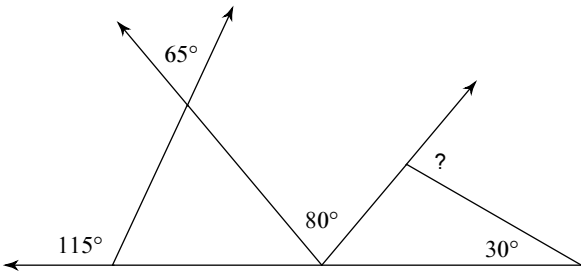

330)

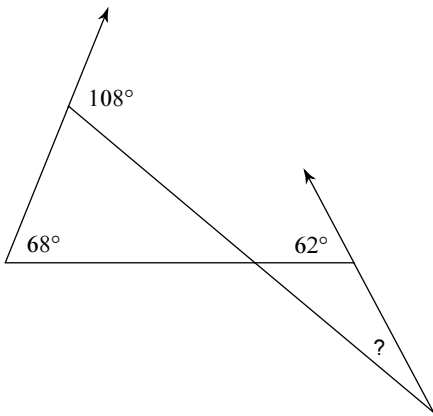

331)

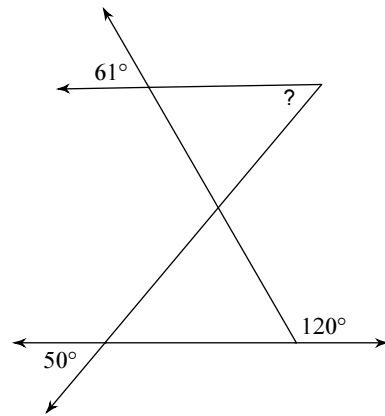

332)

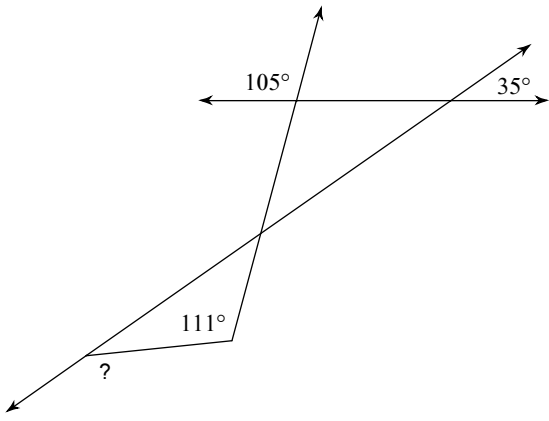

333)

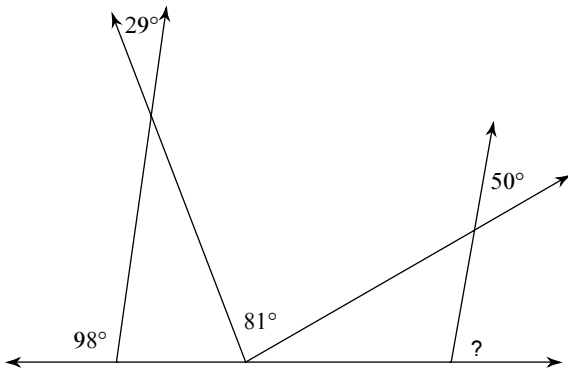

334)

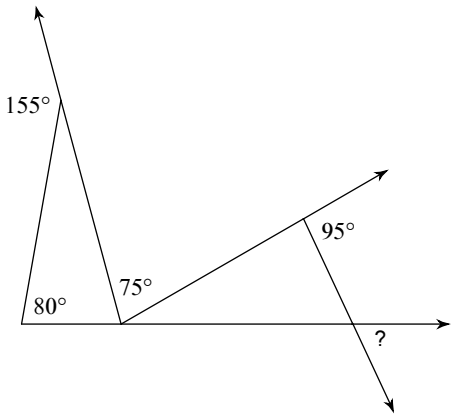

335)

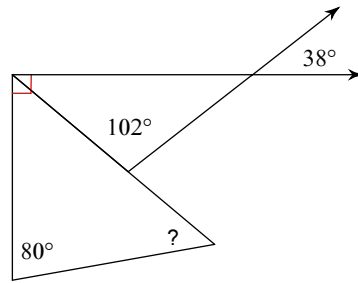

336)

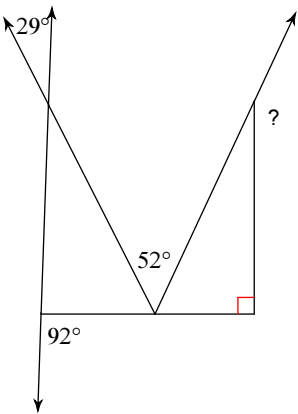

337)

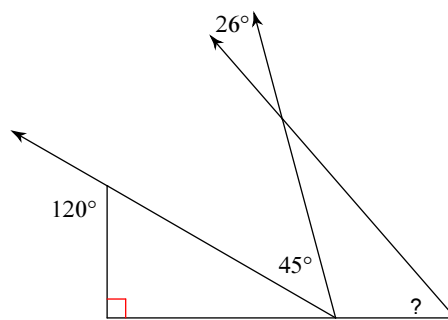

338)

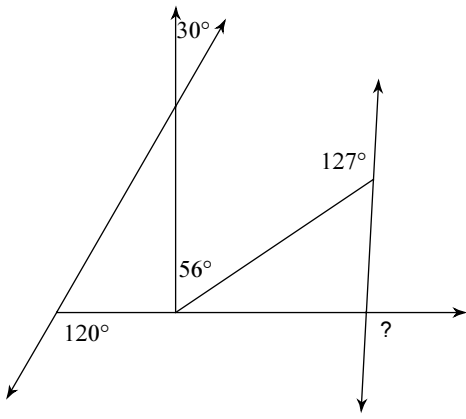

339)

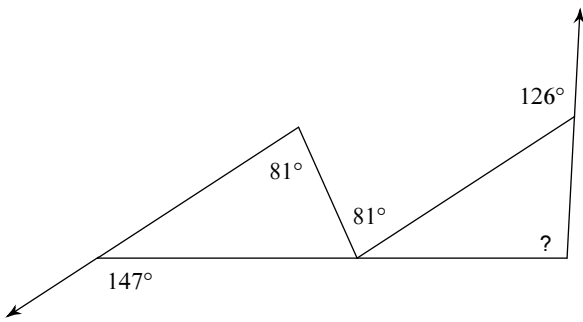

340)

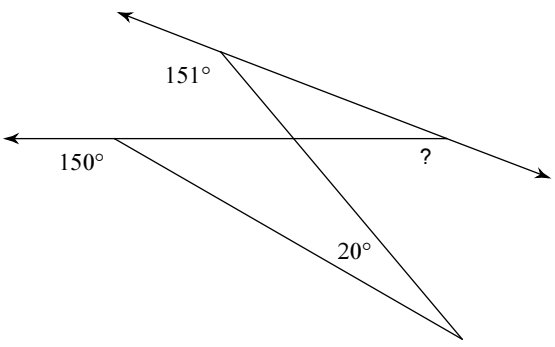

341)

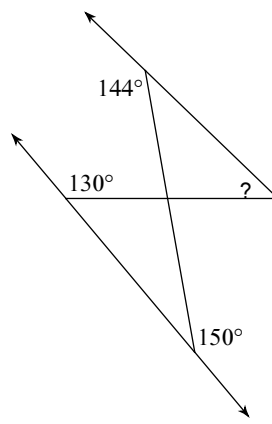

342)

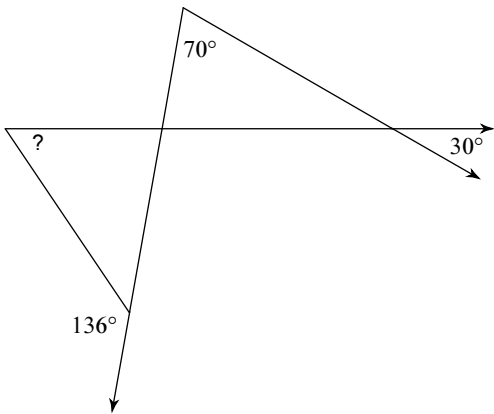

343)

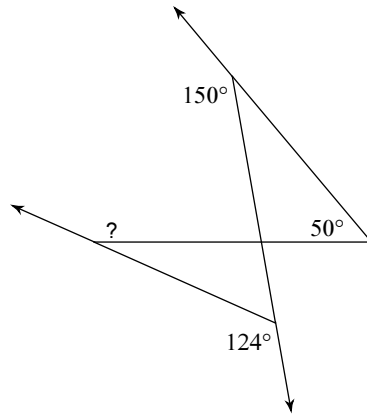

344)

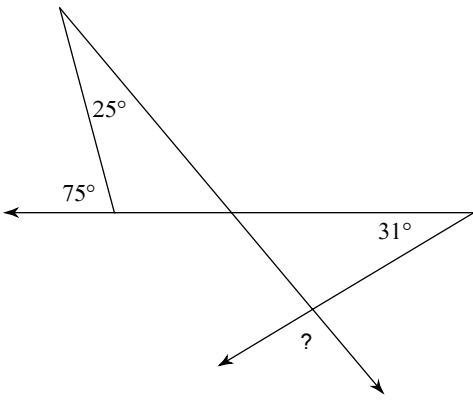

345)

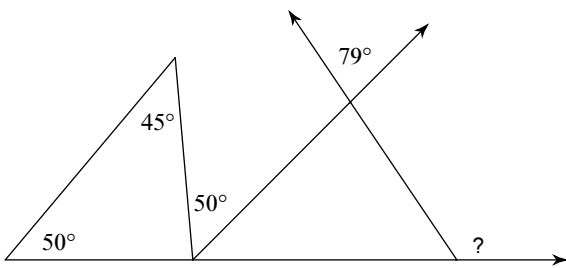

346)

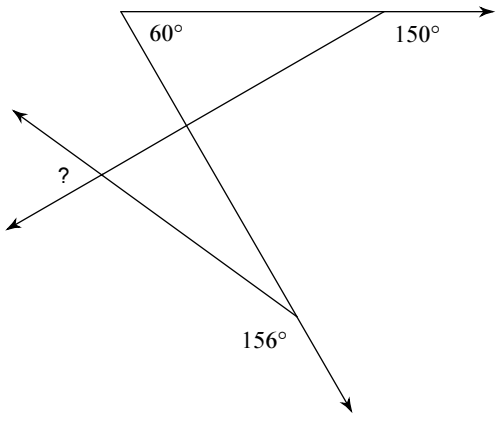

347)

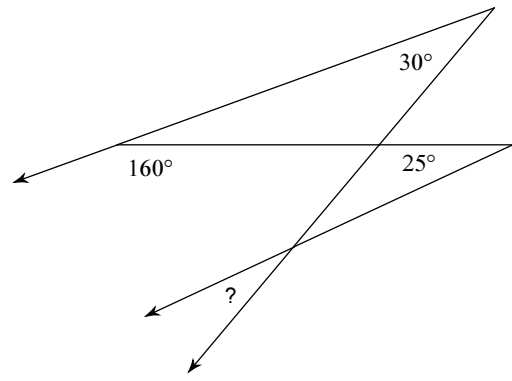

348)

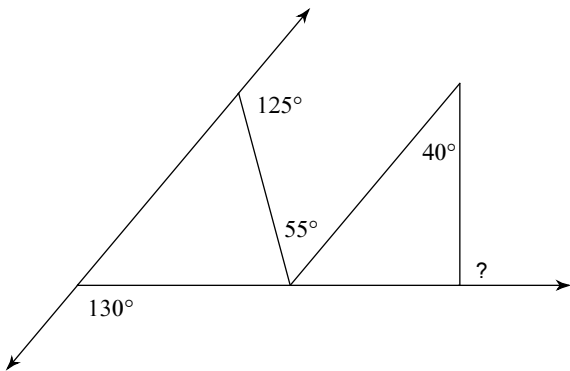

349)

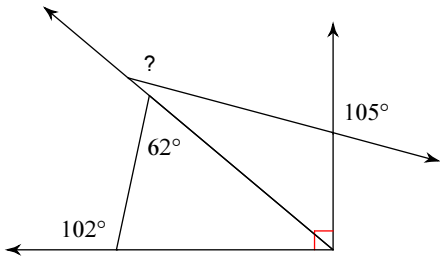

350)

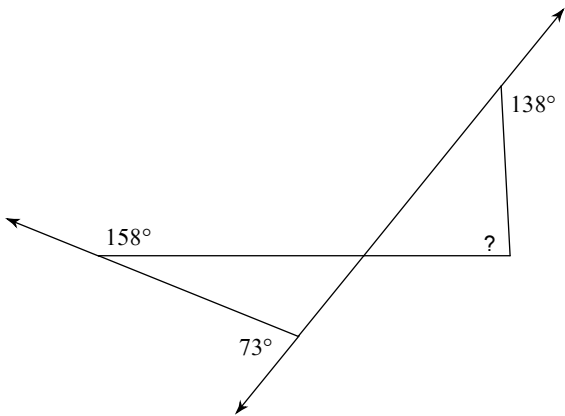

351)

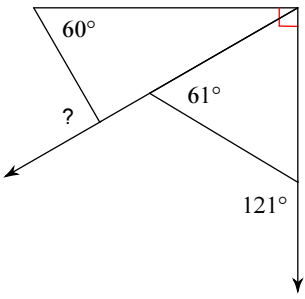

352)

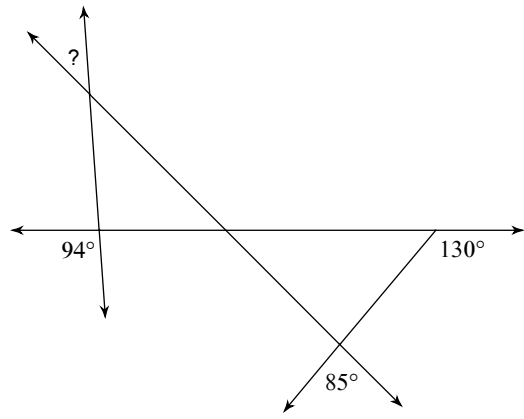

353)

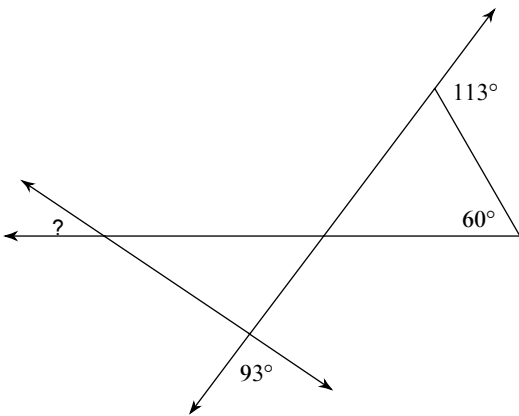

354)

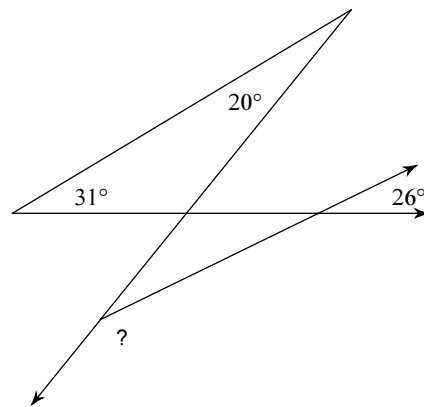

355)

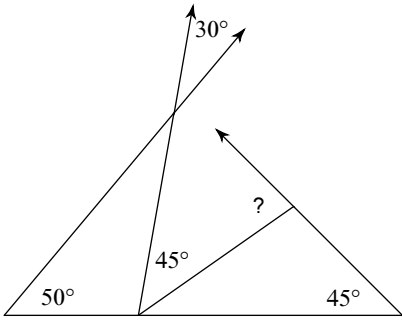

356)

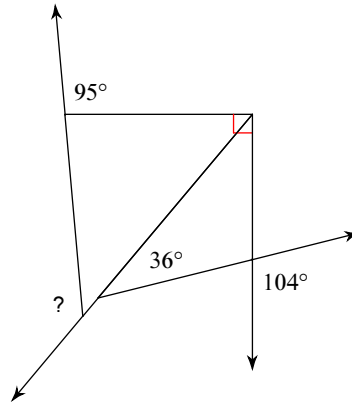

357)

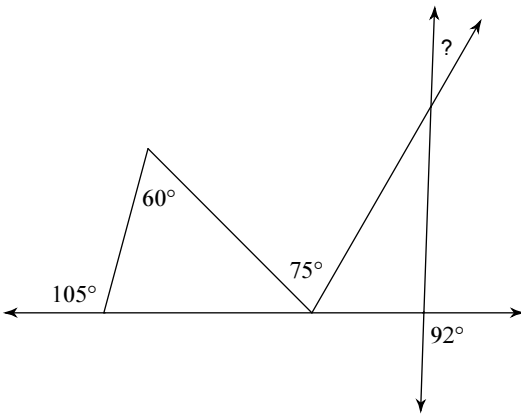

358)

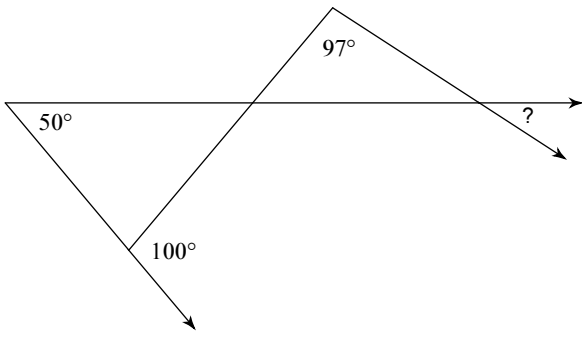

359)

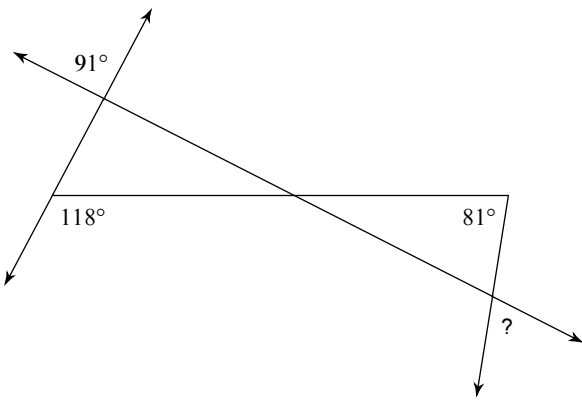

360)

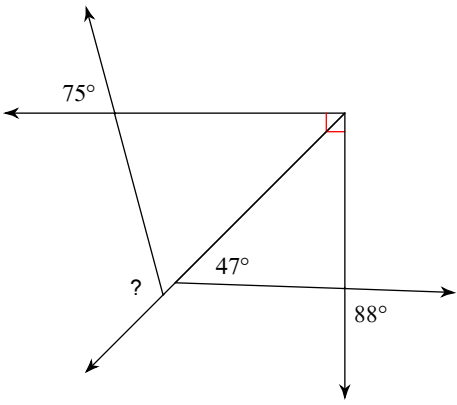

361)

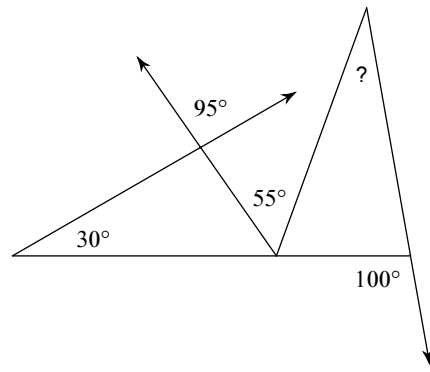

362)

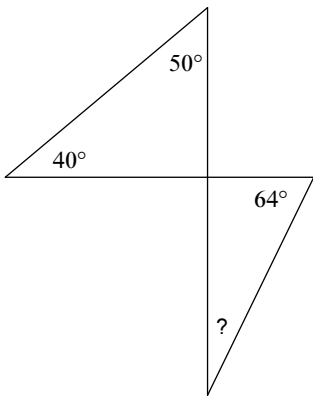

363)

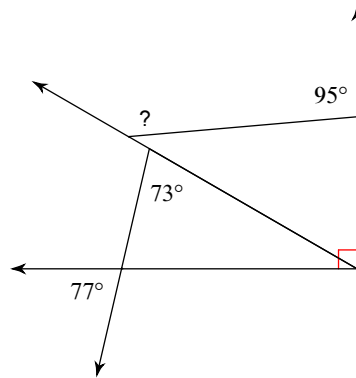

364)

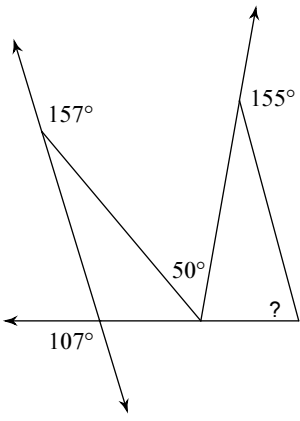

365)

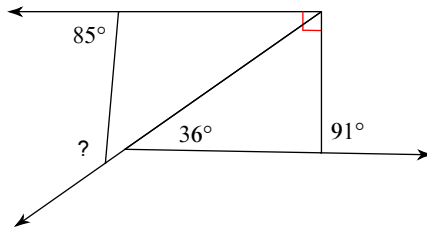

366)

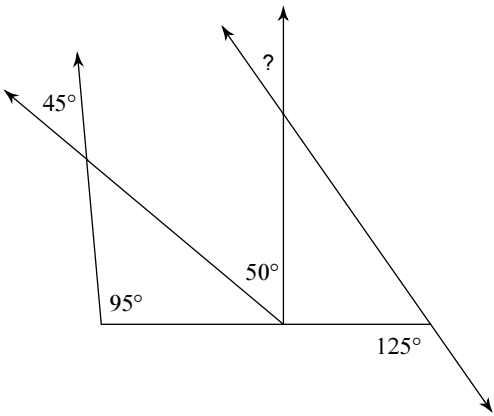

367)

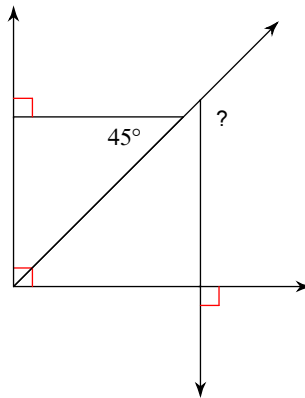

368)

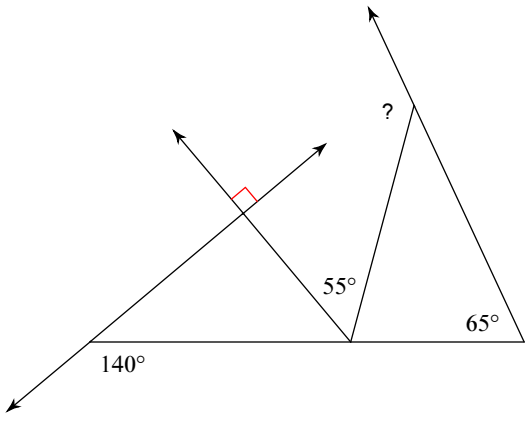

369)

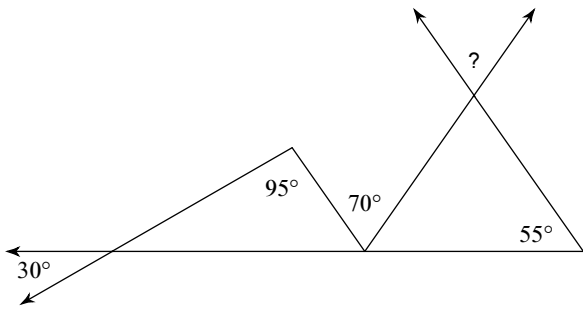

370)

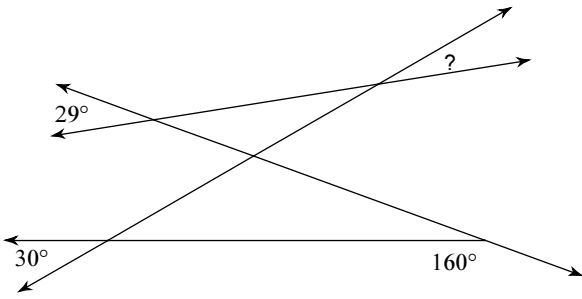

371)

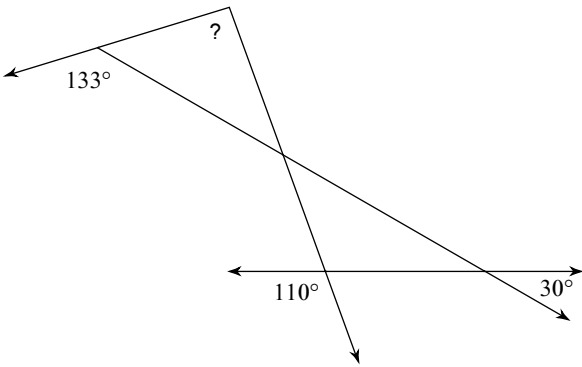

372)

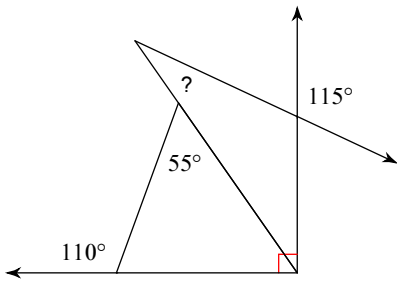

373)

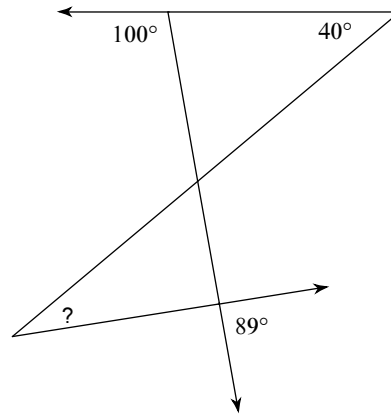

374)

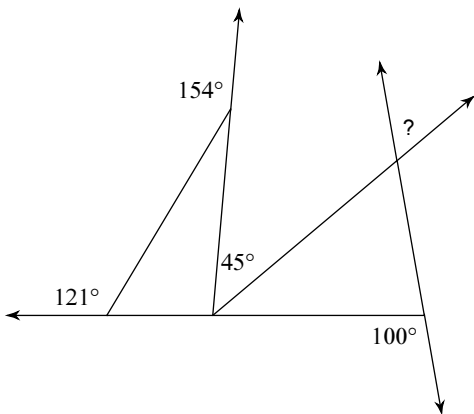

375)

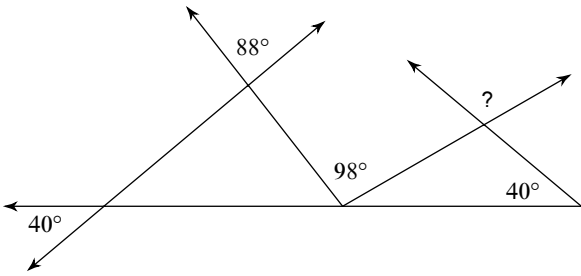

376)

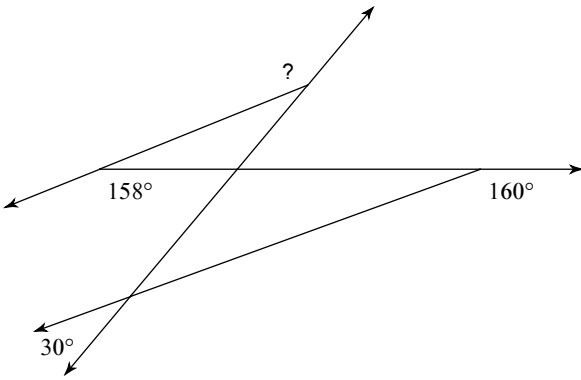

377)

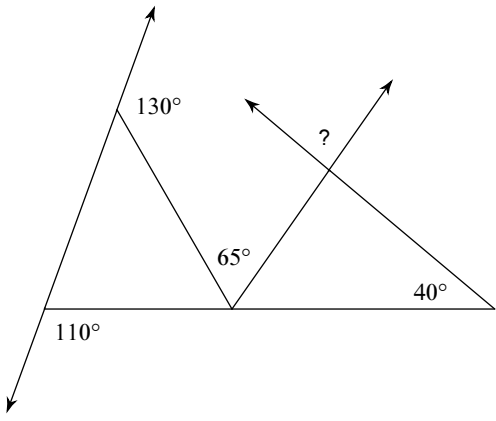

378)

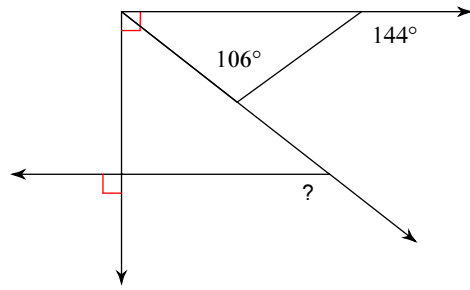

379)

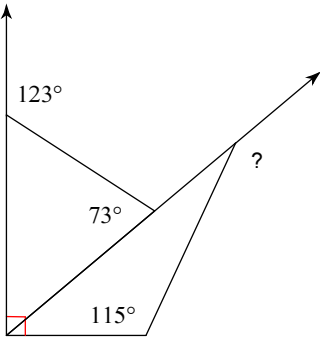

380)

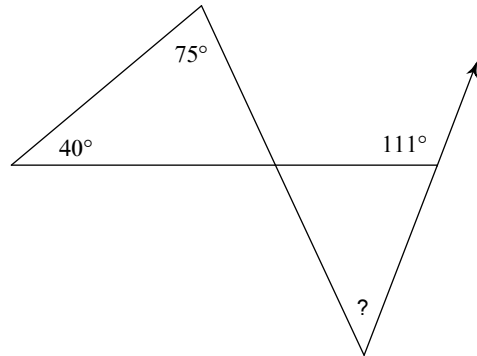

381)

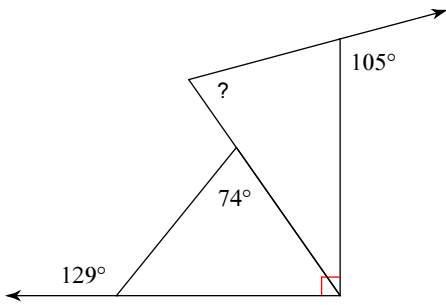

382)

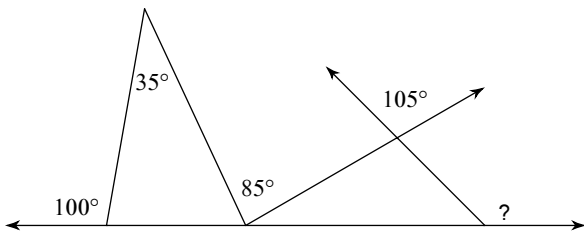

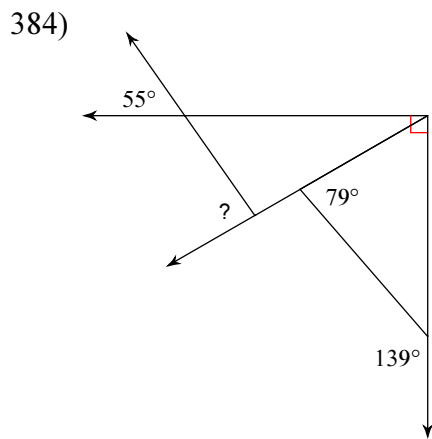
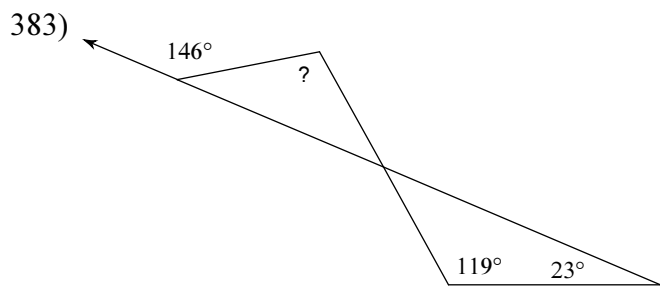

385)

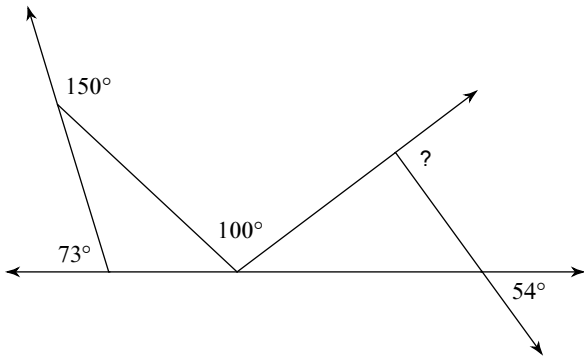

386)

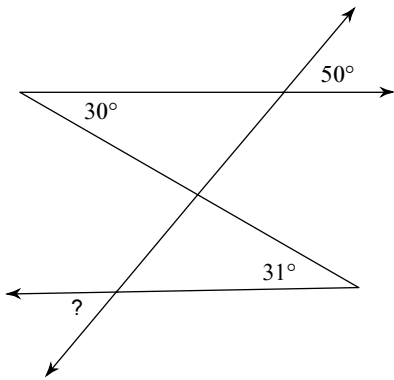

387)

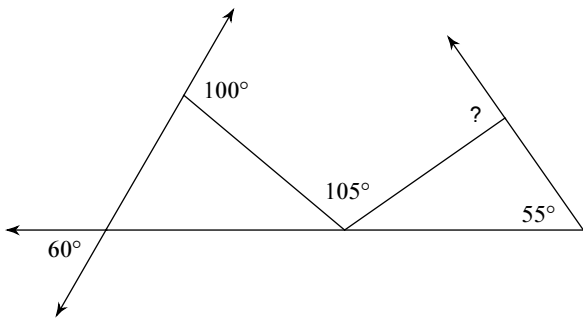

388)

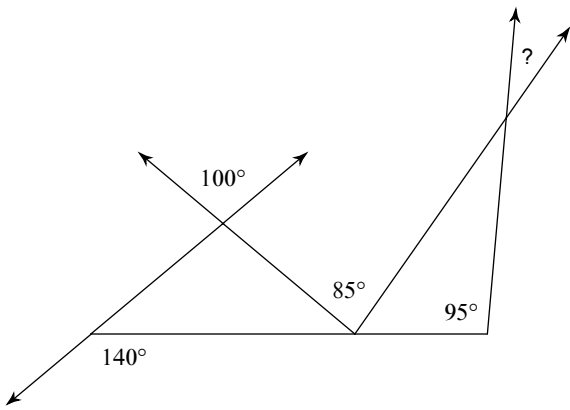

389)

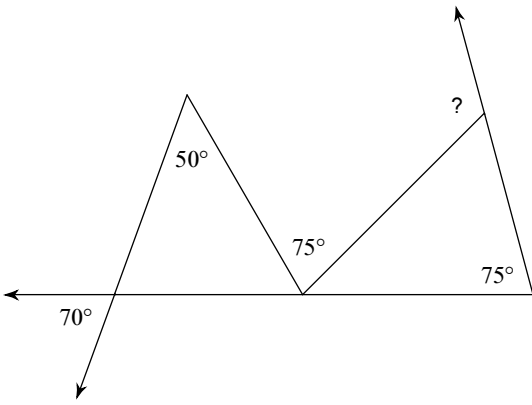

390)

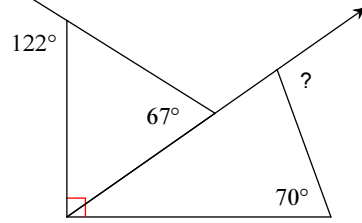

391)

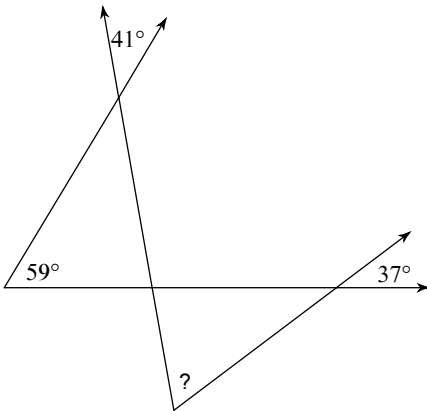

392)

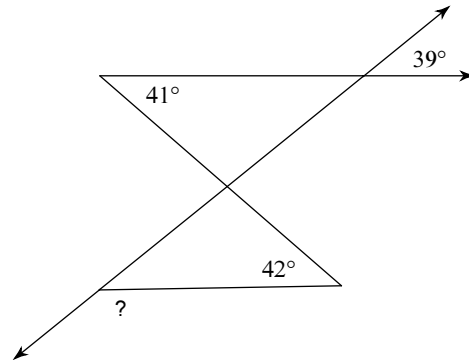

393)

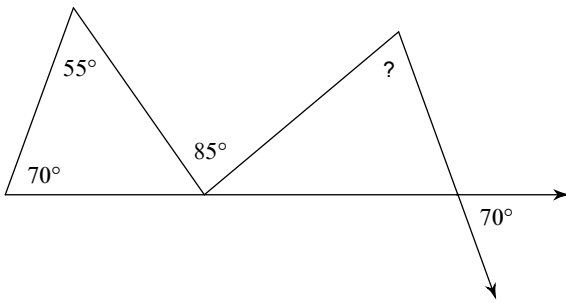

394)

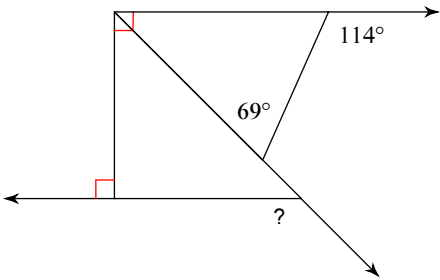

395)

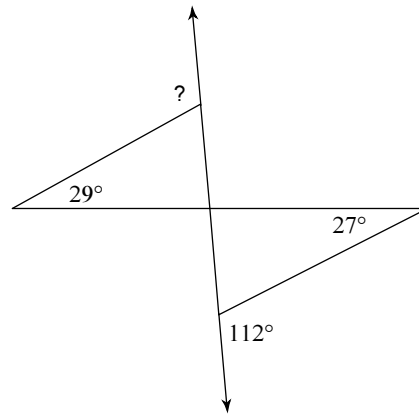

396)

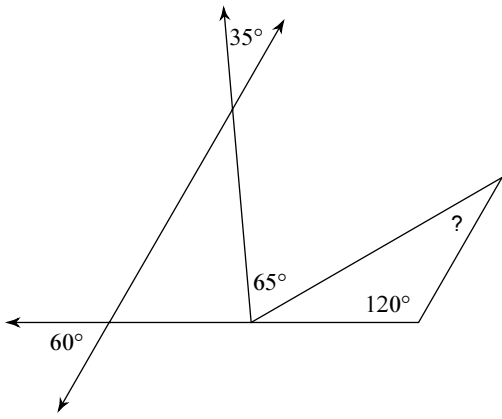

397)

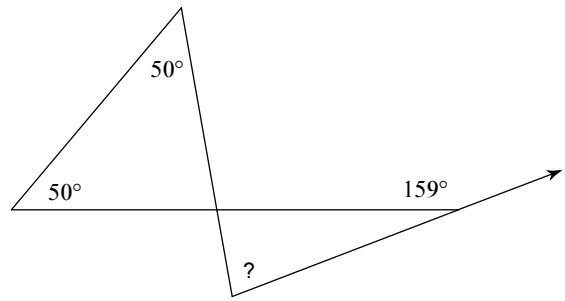

398)

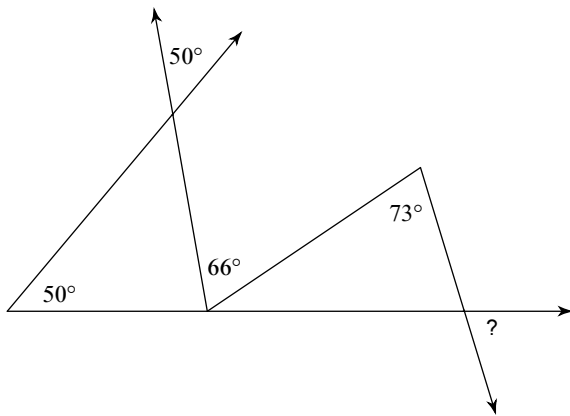

399)

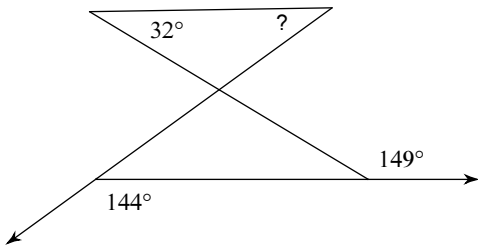

400)

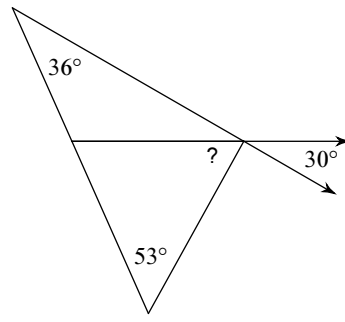

The sum of angles in a triangle - Multi-step solving

Find the value of x in multi-step equations:

1)

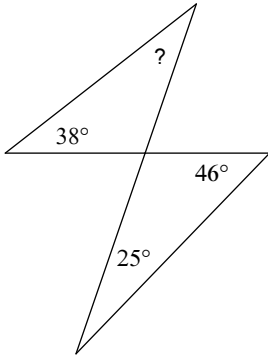

33°

2)

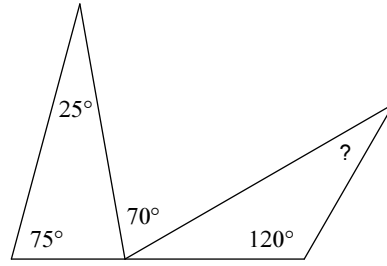

30°

3)

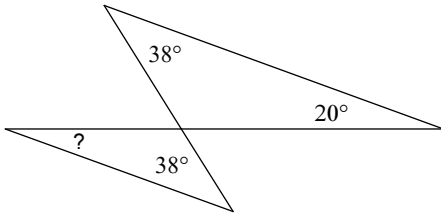

20°

4)

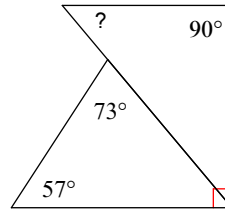

50°

5)

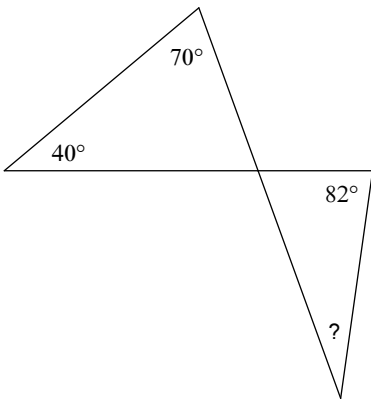

28°

6)

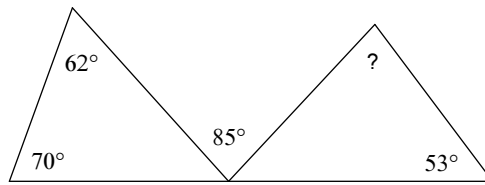

80°

7)

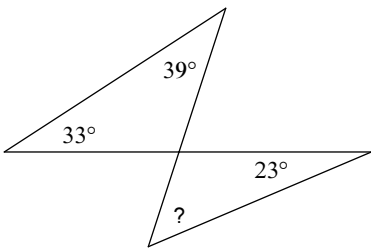

49°

8)

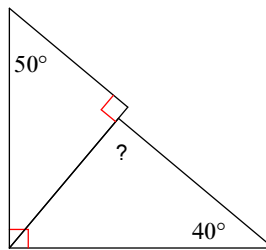

90°

9)

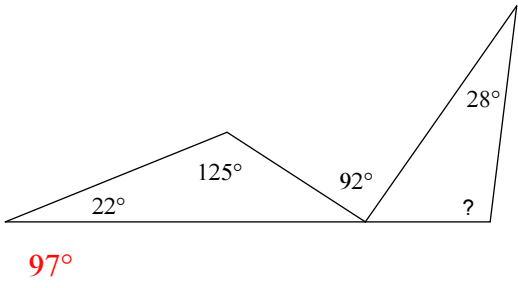

10)

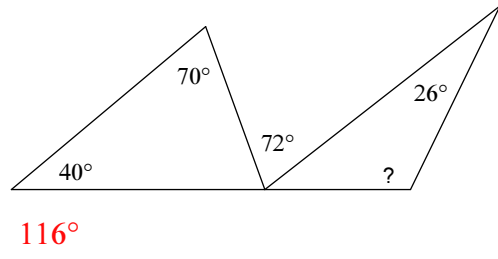

11)

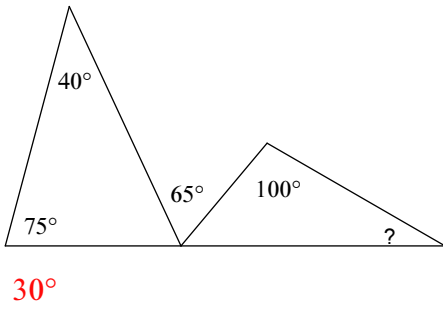

12)

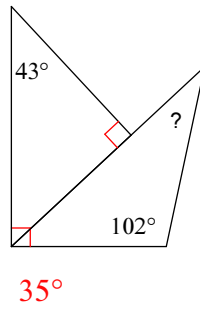

13)

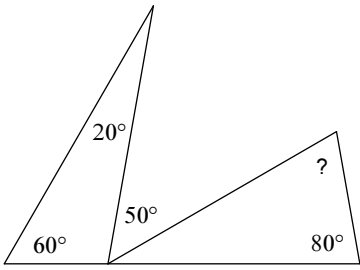

70°

14)

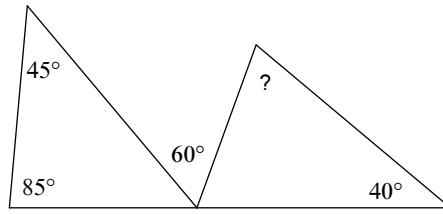

70°

15)

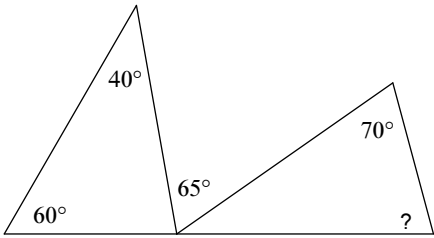

75°

16)

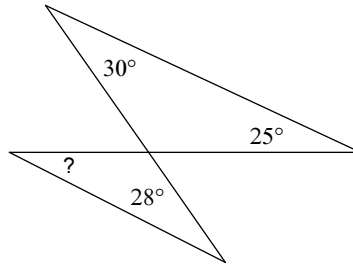

27°

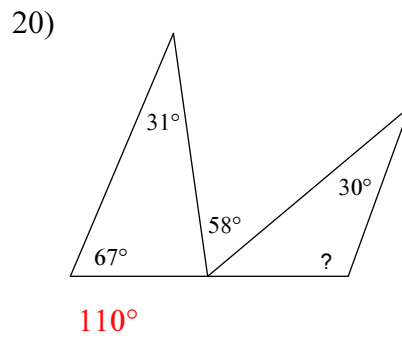
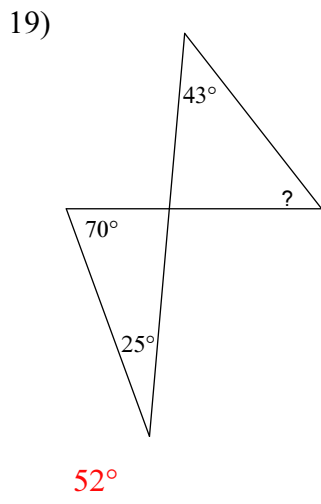
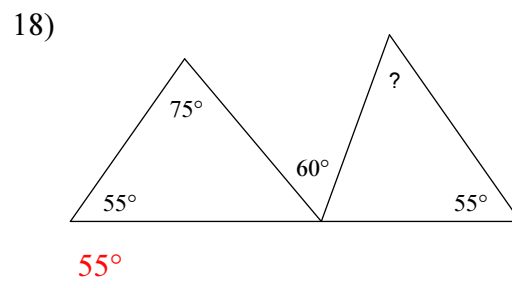
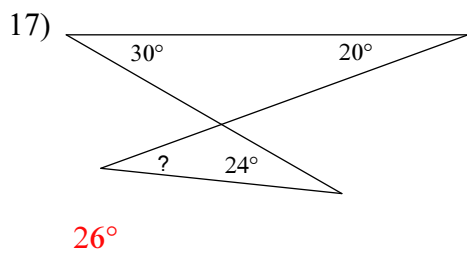

21)

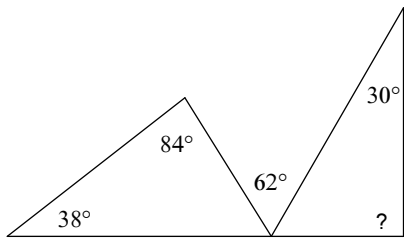

90°

22)

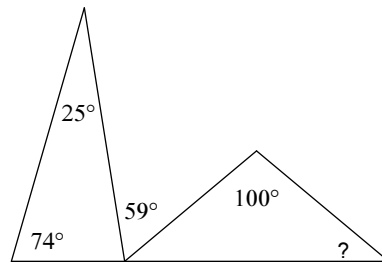

40°

23)

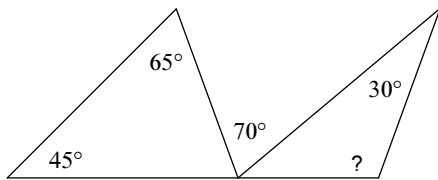

110°

24)

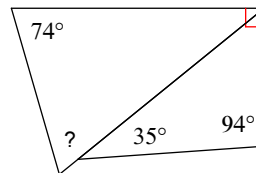

67°

25)

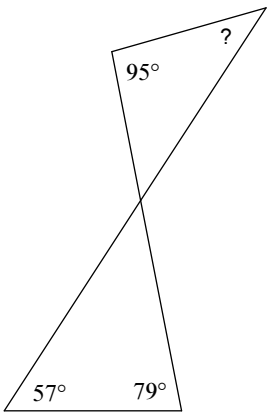

41°

26)

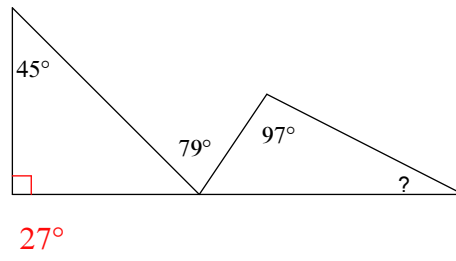

27)

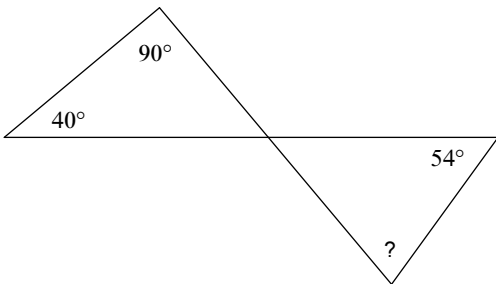

76°

28)

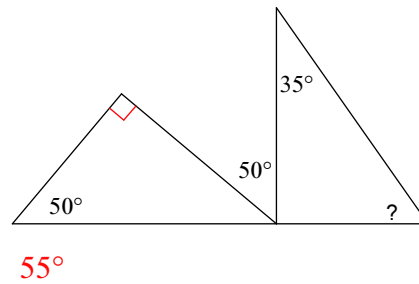

29)

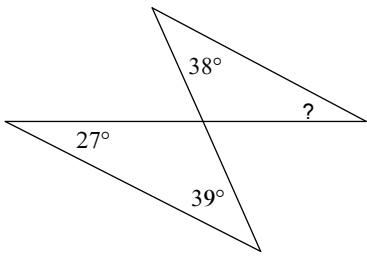

28°

30)

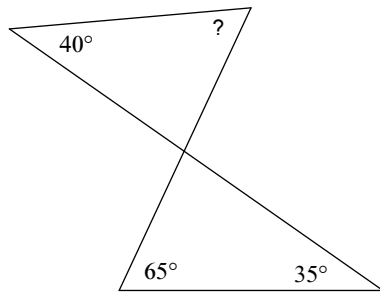

60°

31)

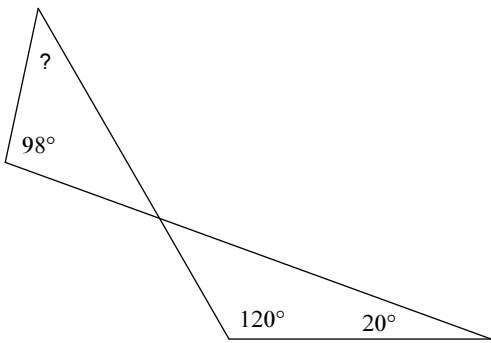

42°

32)

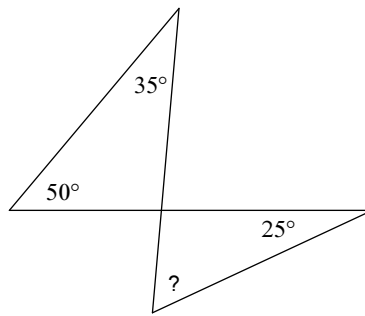

60°

33)

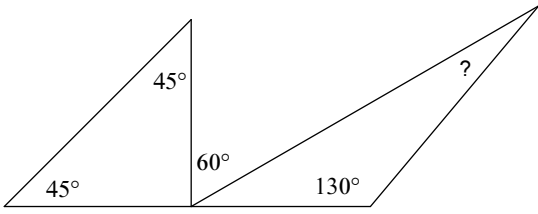

20°

34)

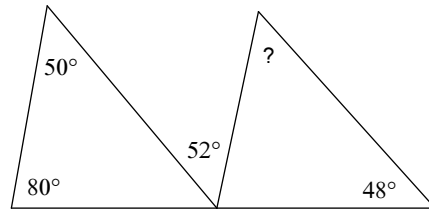

54°

35)

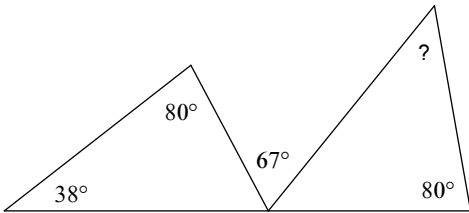

49°

36)

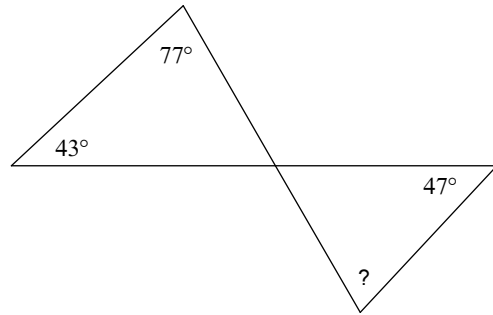

73°

37)

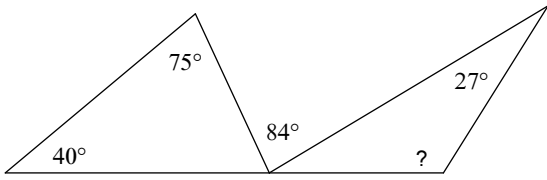

122°

38)

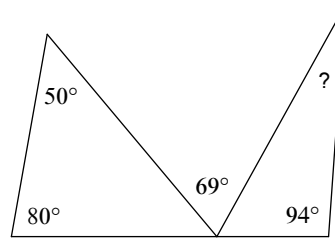

25°

39)

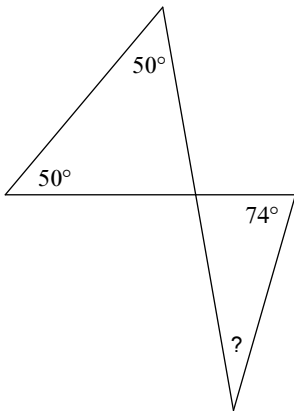

26°

40)

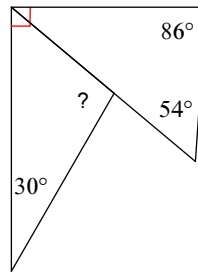

100°

41)

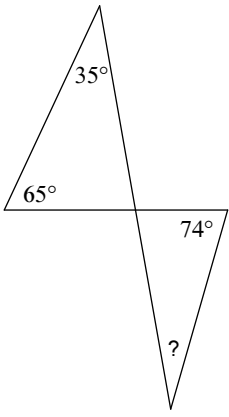

26°

42)

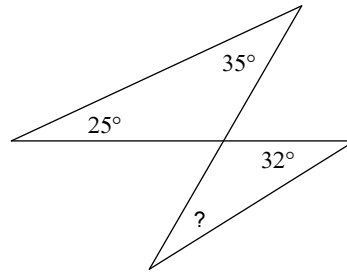

28°

43)

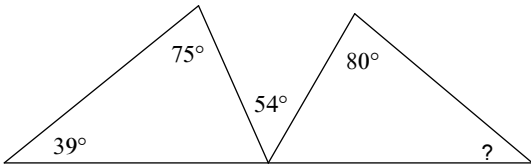

40°

44)

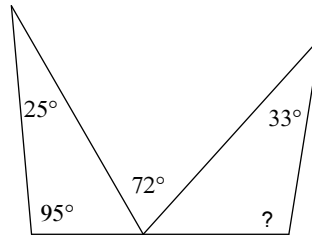

99°

45)

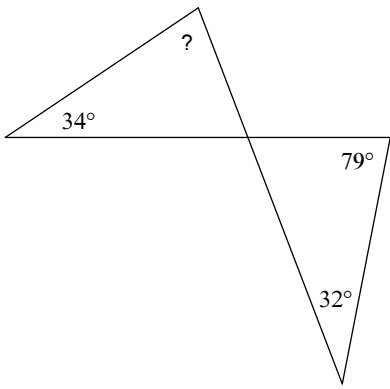

77°

46)

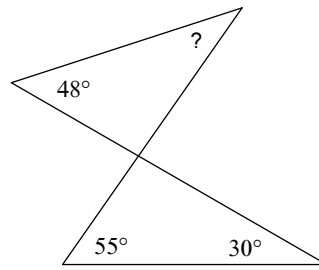

37°

47)

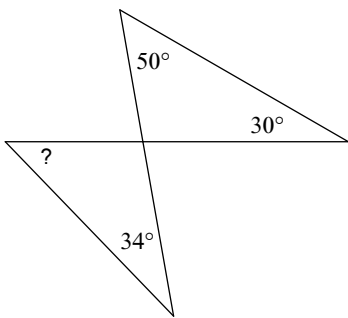

46°

48)

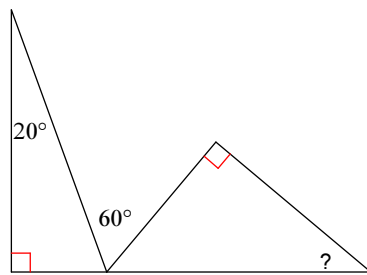

40°

49)

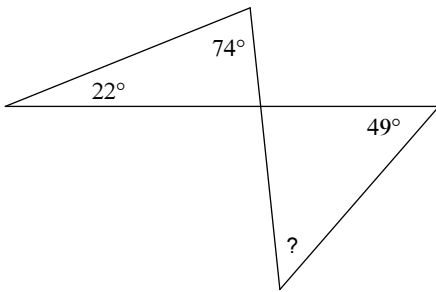

47°

50)

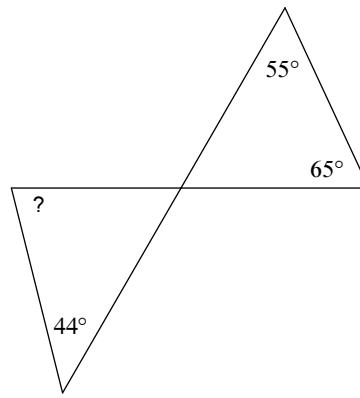

76°

51)

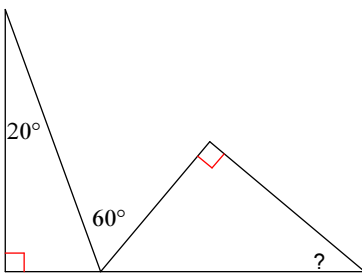

40°

52)

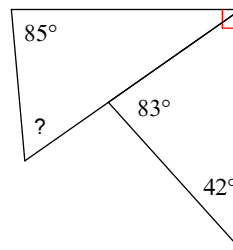

60°

53)

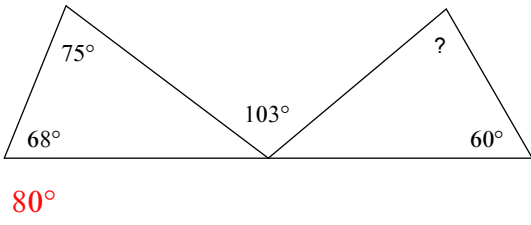

54)

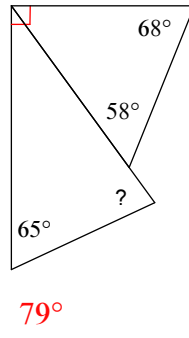

55)

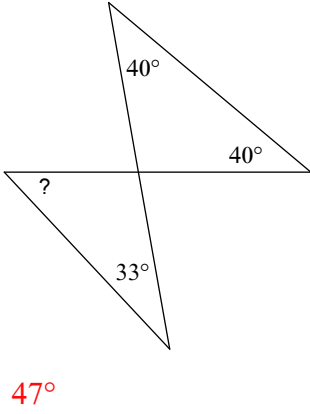

56)

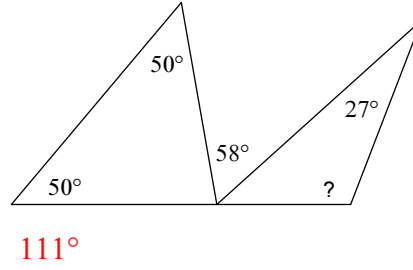

57)

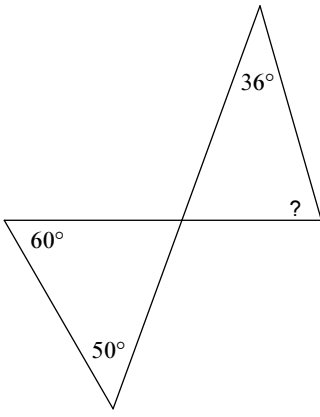

74°

58)

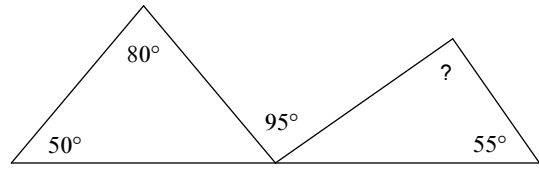

90°

59)

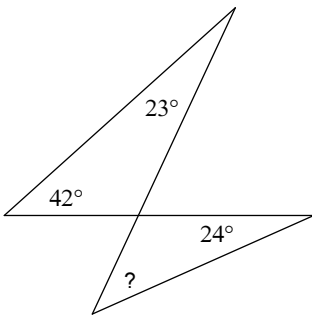

41°

60)

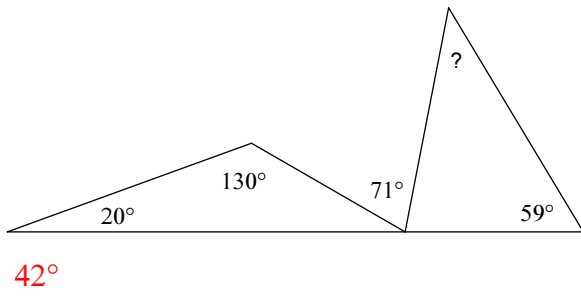

61)

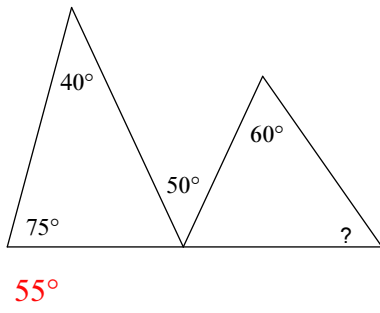

62)

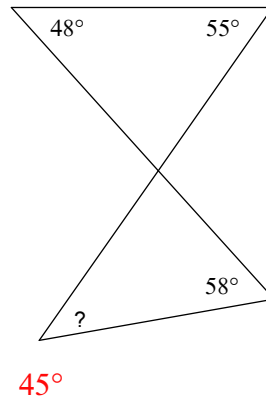

63)

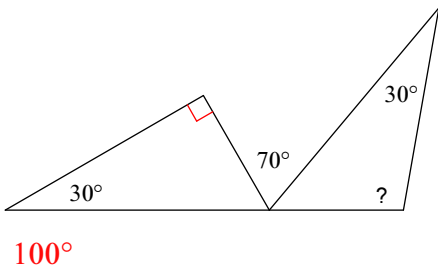

64)

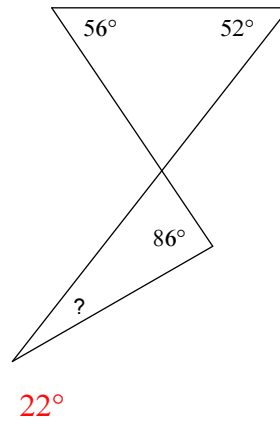

65)

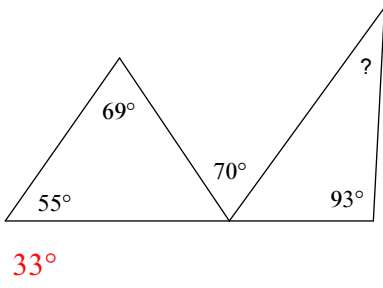

66)

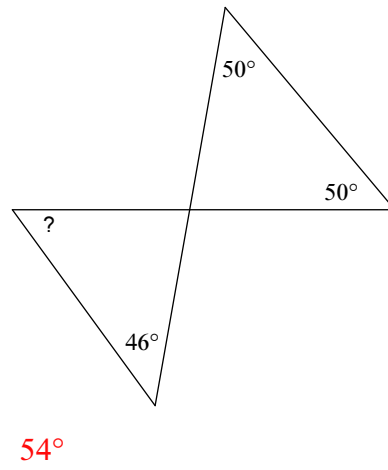

67)

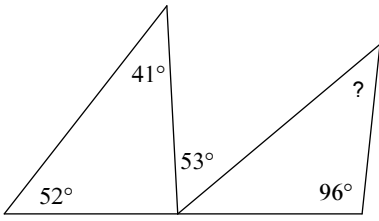

44°

68)

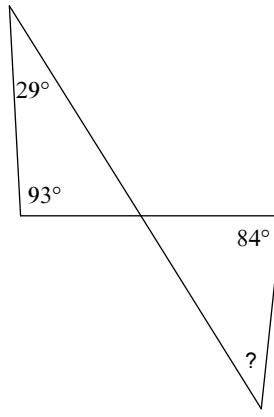

38°

69)

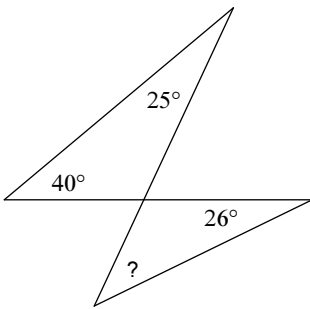

39°

70)

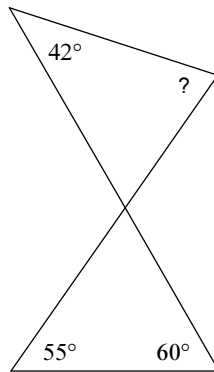

73°

71)

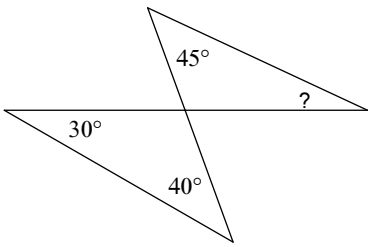

25°

72)

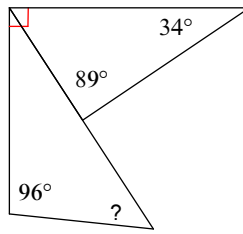

51°

73)

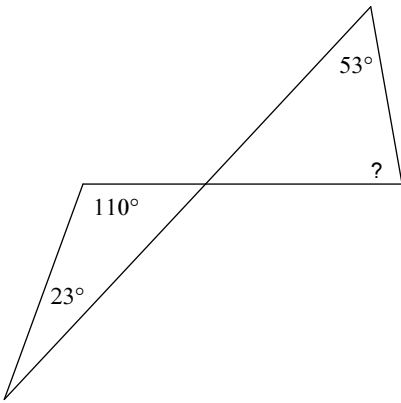

80°

74)

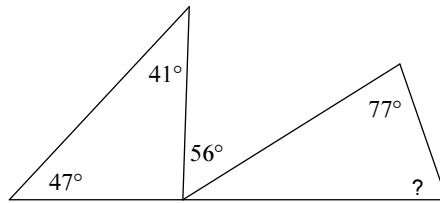

71°

75)

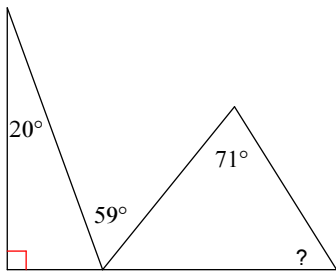

58°

76)

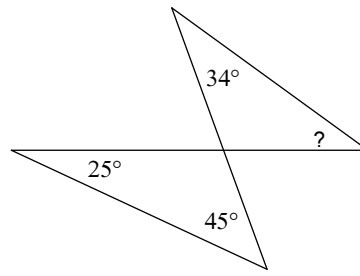

36°

77)

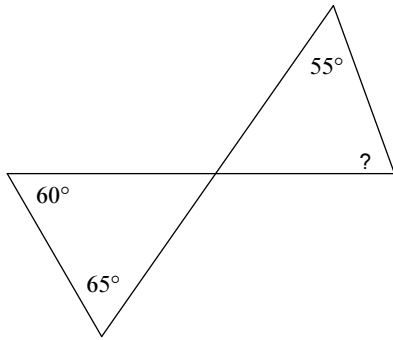

70°

78)

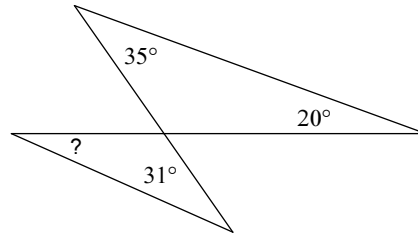

24°

79)

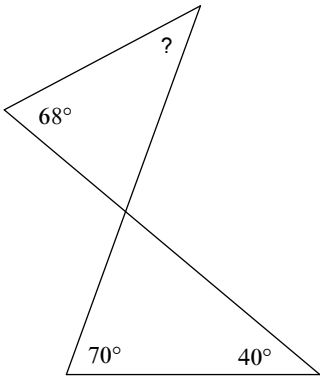

42°

80)

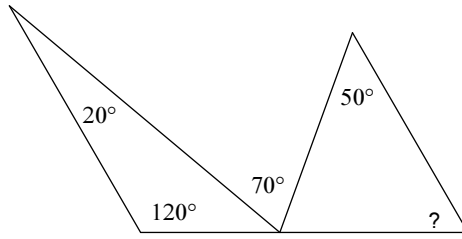

60°

81)

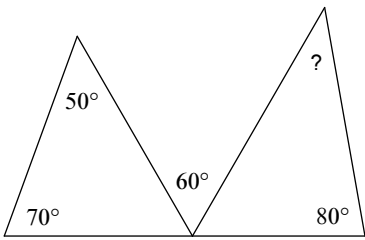

40°

82)

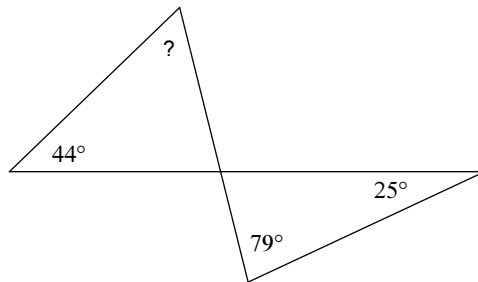

60°

83)

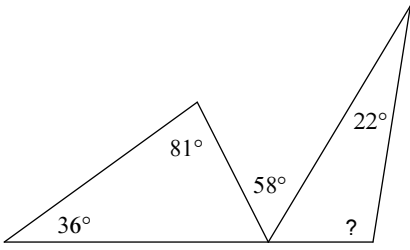

99°

84)

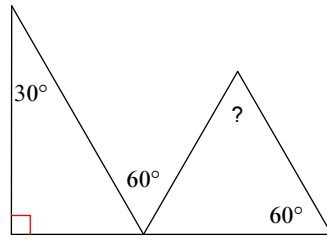

60°

85)

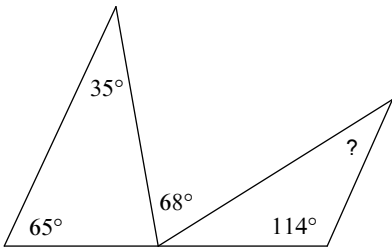

34°

86)

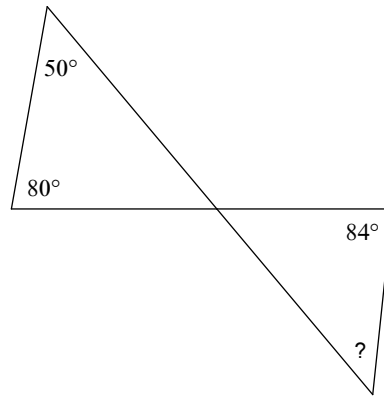

46°

87)

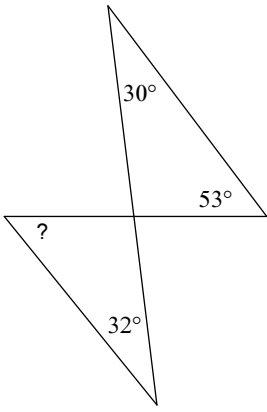

51°

88)

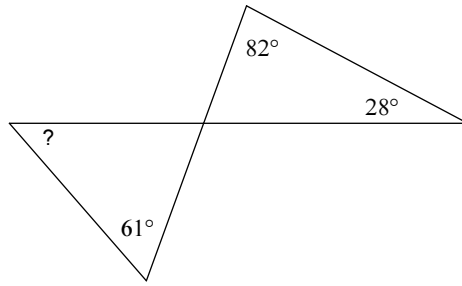

49°

89)

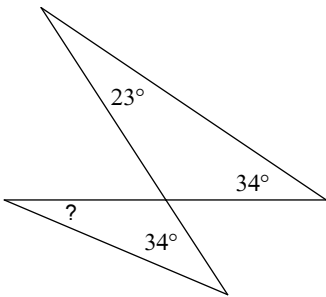

23°

90)

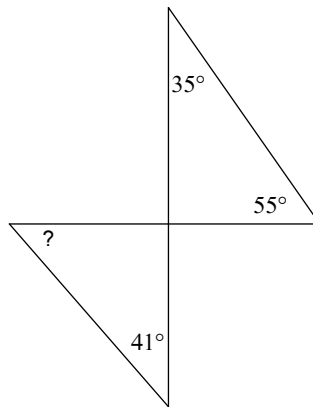

49°

91)

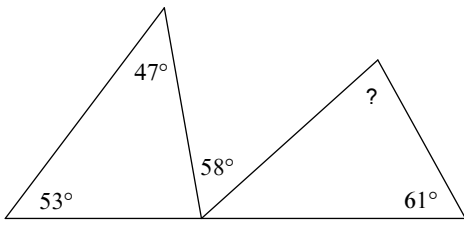

77°

92)

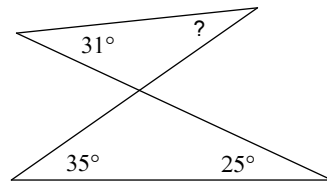

29°

93)

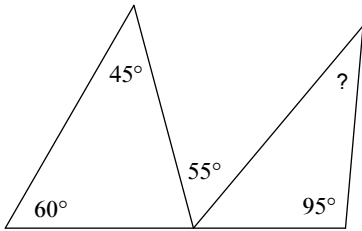

35°

94)

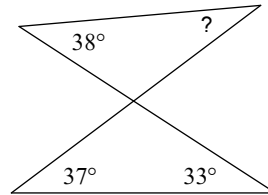

32°

95)

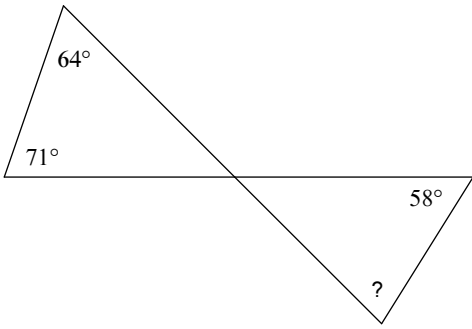

77°

96)

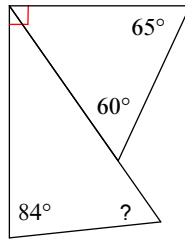

61°

97)

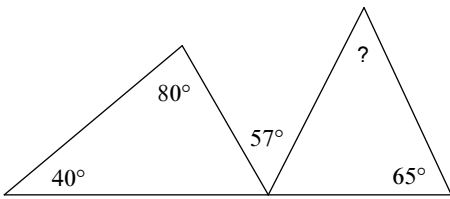

52°

98)

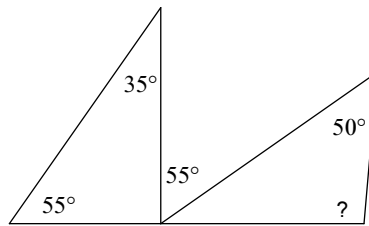

95°

99)

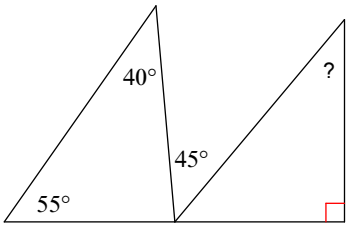

40°

100)

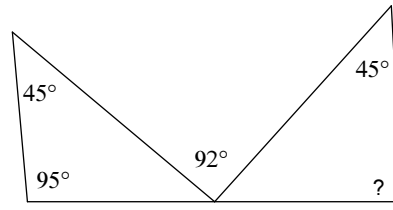

87°

101)

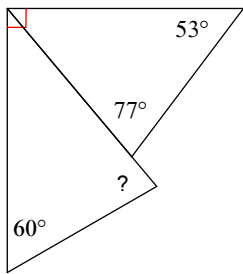

80°

102)

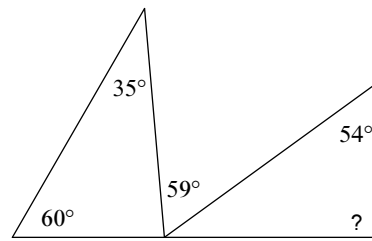

90°

103)

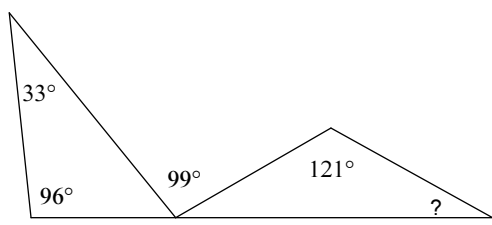

29°

104)

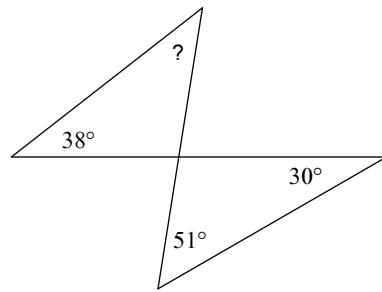

43°

105)

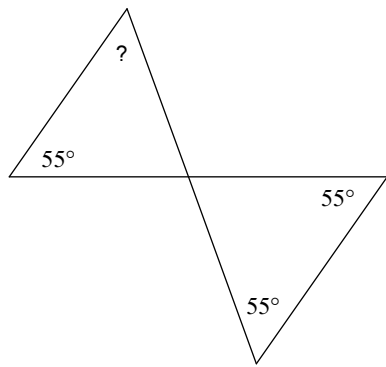

55°

106)

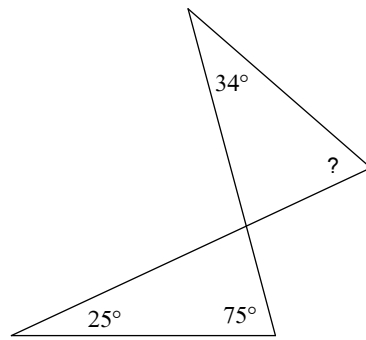

66°

107)

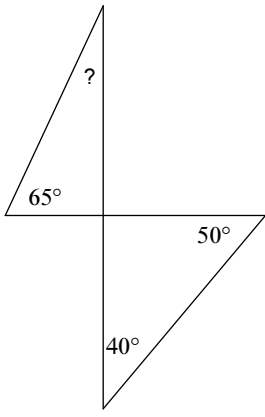

25°

108)

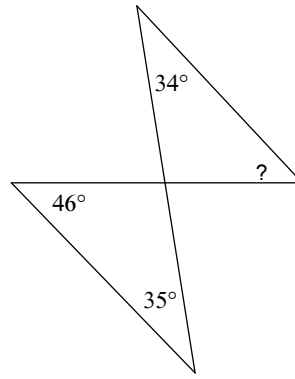

47°

109)

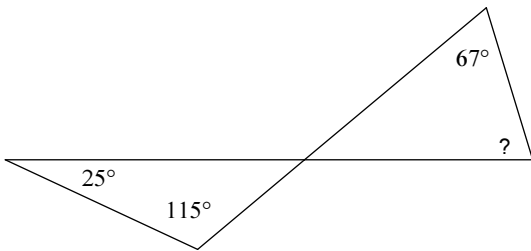

73°

110)

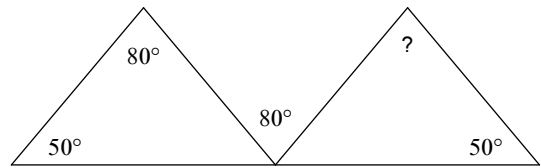

80°

111)

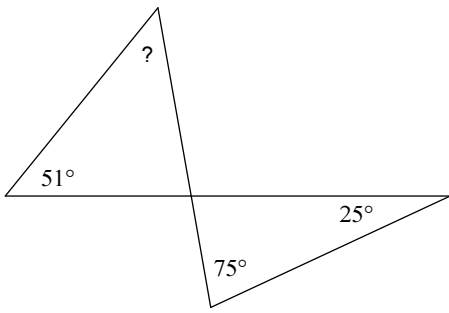

49°

112)

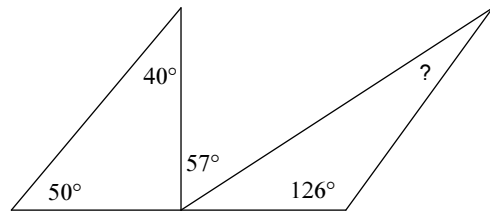

21°

113)

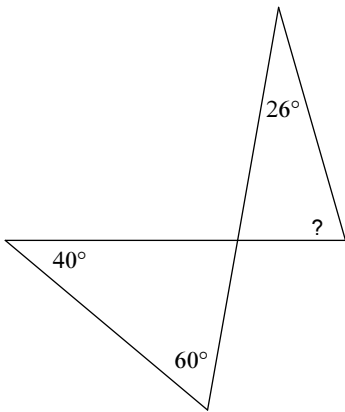

74°

114)

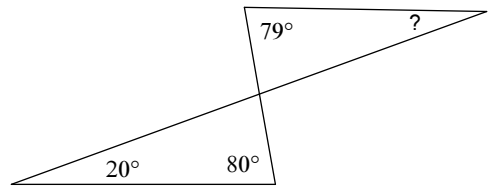

21°

115)

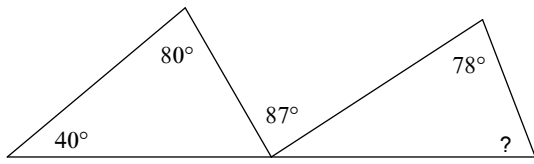

69°

116)

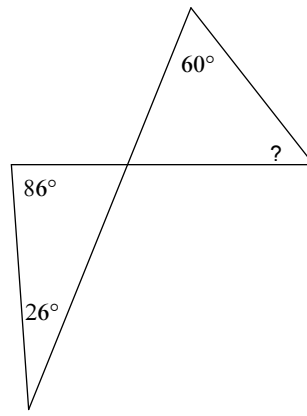

52°

117)

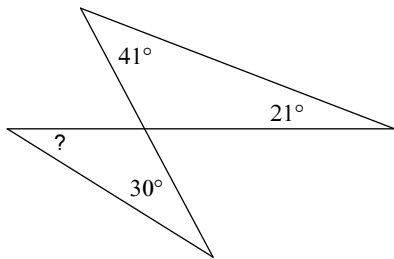

32°

118)

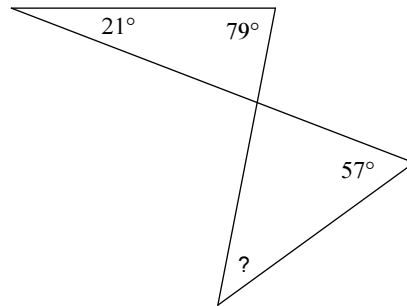

43°

119)

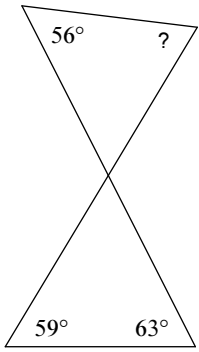

66°

120)

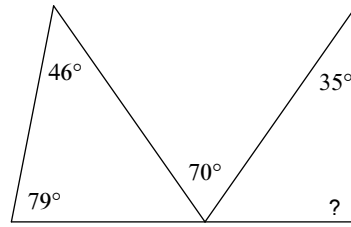

90°

121)

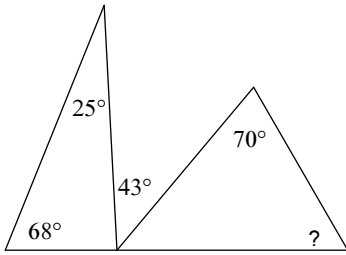

60°

122)

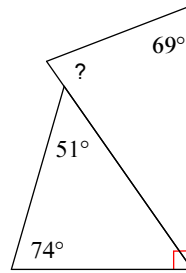

76°

123)

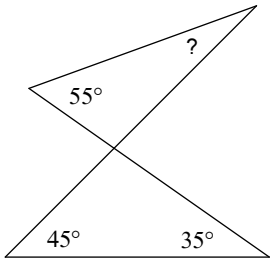

25°

124)

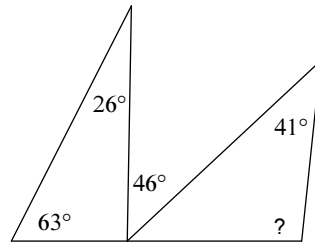

96°

125)

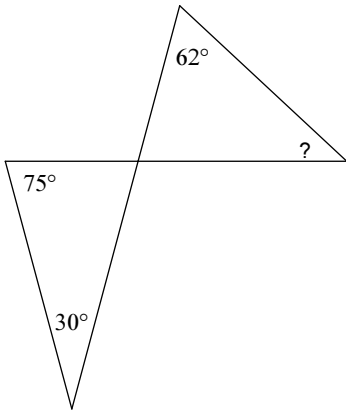

43°

126)

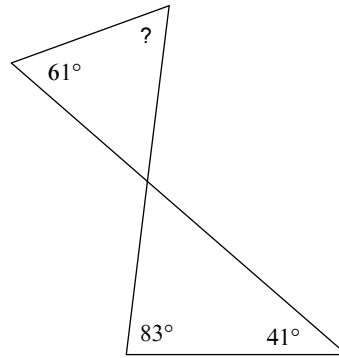

63°

127)

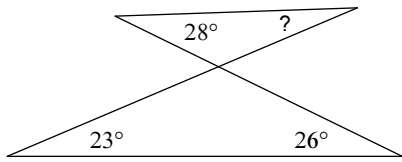

21°

128)

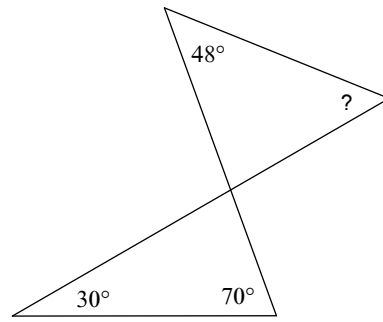

52°

129)

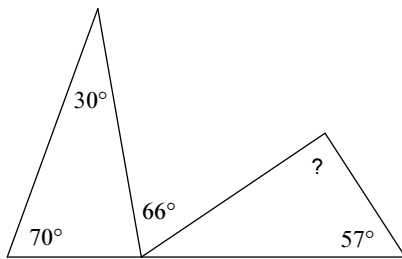

89°

130)

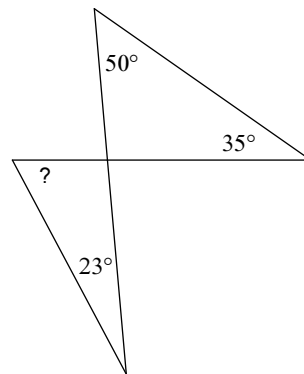

62°

131)

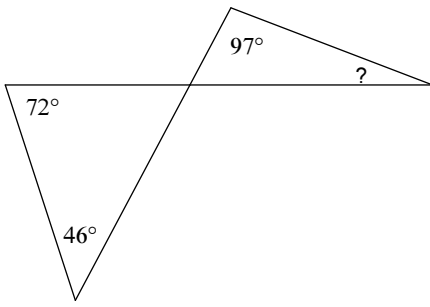

21°

132)

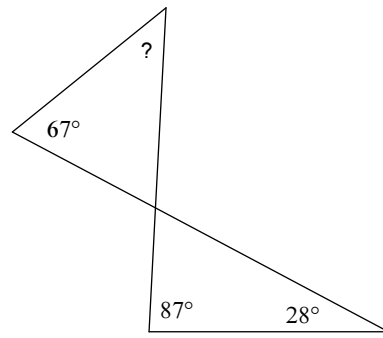

48°

133)

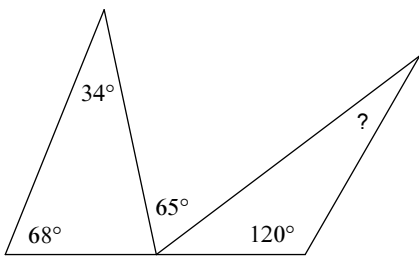

23°

134)

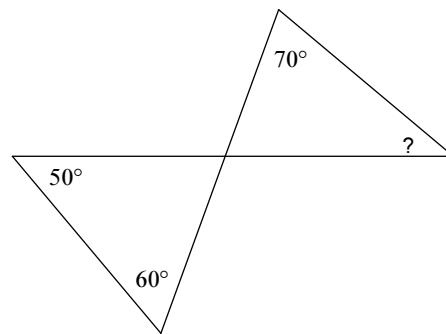

40°

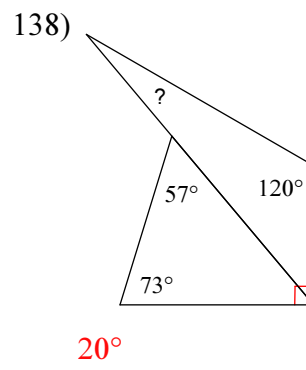
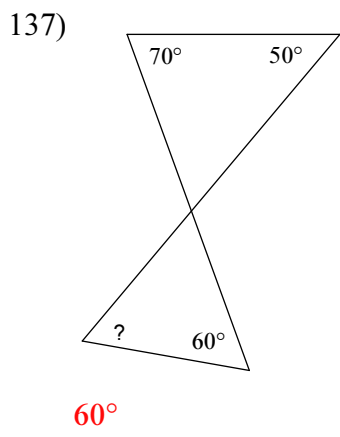
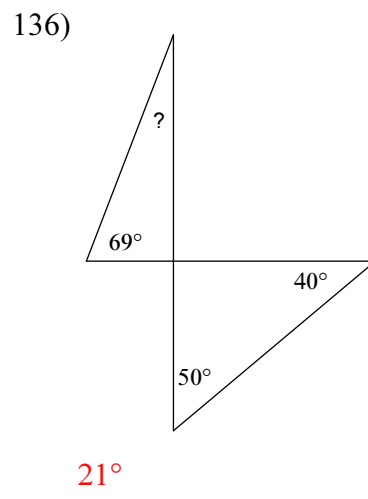
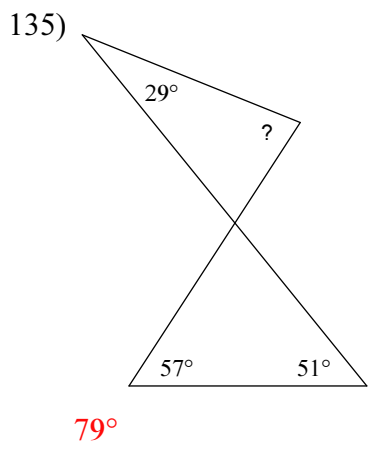

139)

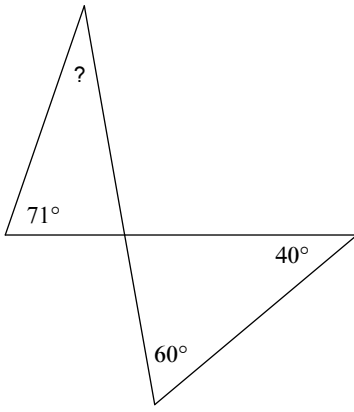

29°

140)

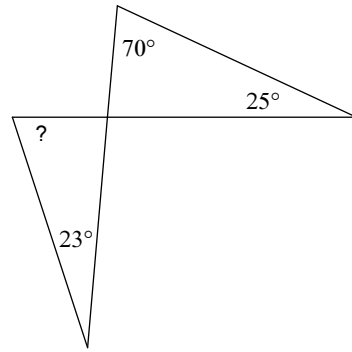

72°

141)

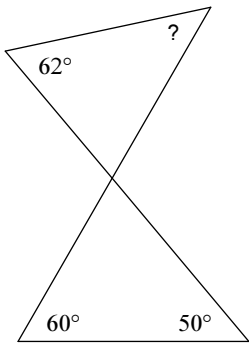

48°

142)

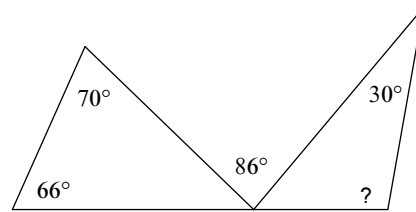

100°

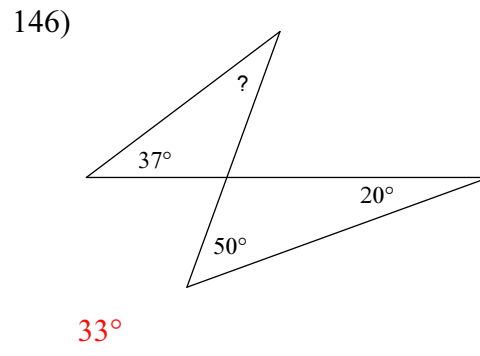
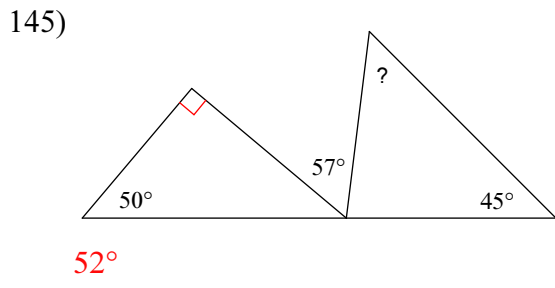
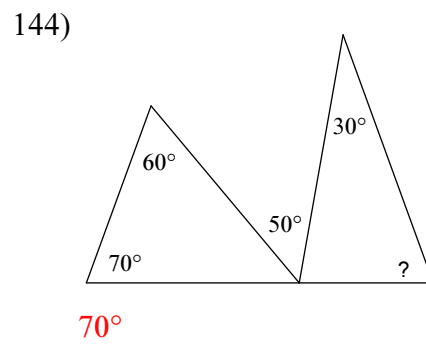
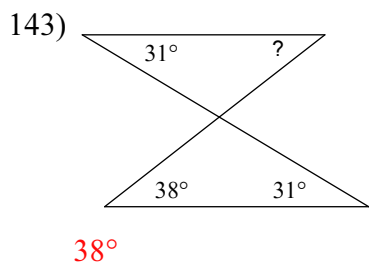

147)

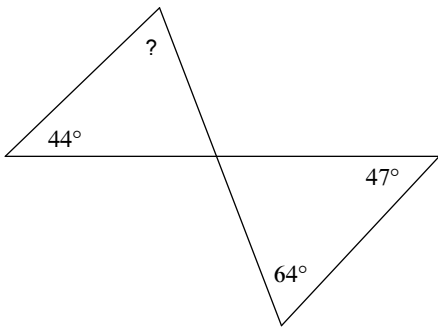

67°

148)

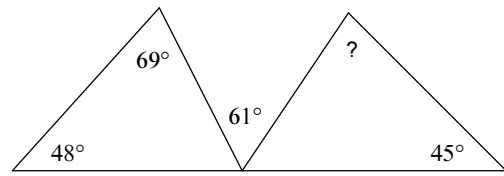

79°

149)

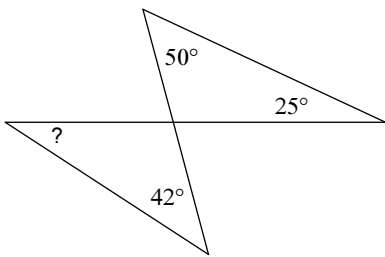

33°

150)

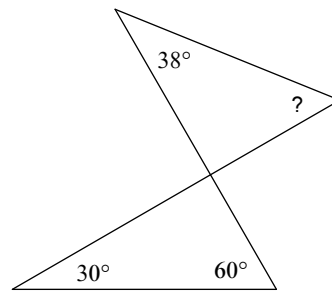

52°

151)

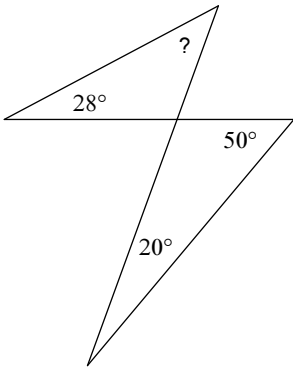

42°

152)

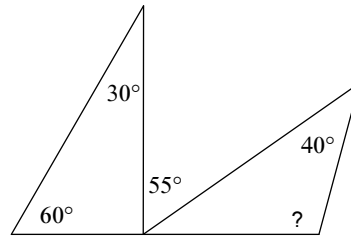

105°

153)

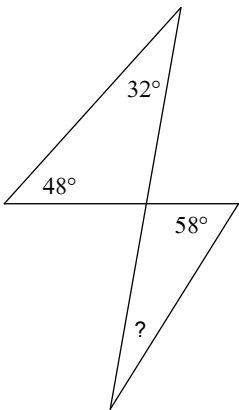

22°

154)

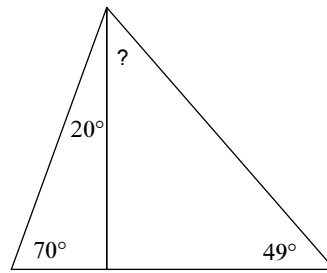

41°

155)

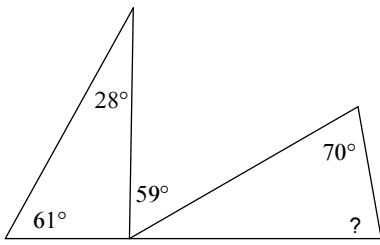

80°

156)

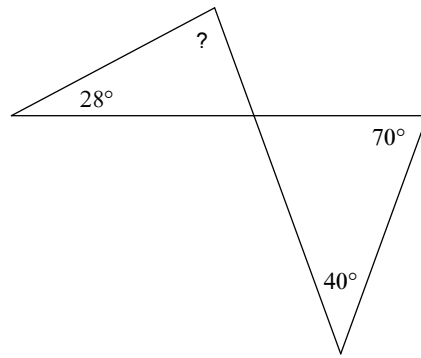

82°

157)

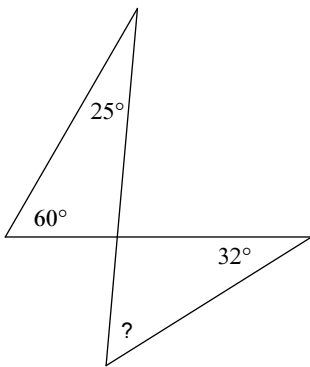

53°

158)

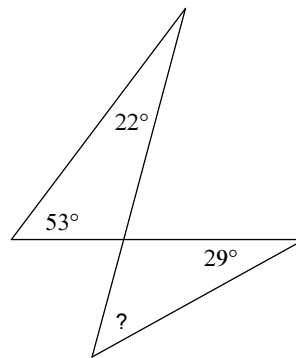

46°

159)

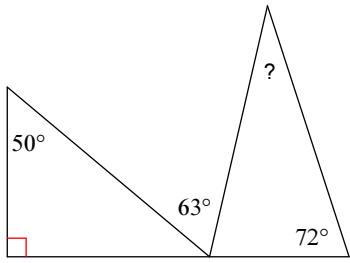

31°

160)

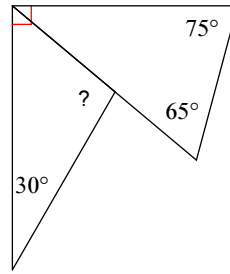

100°

161)

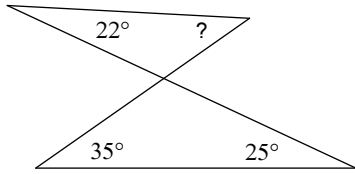

38°

162)

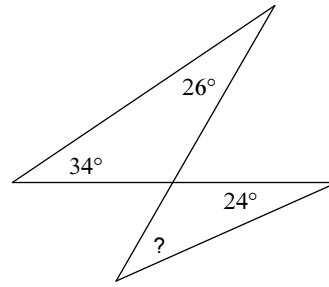

36°

163)

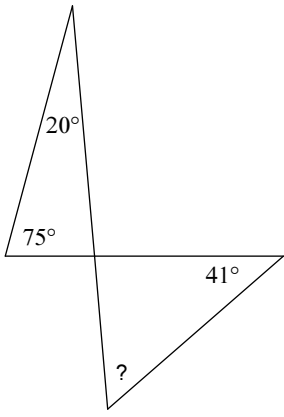

54°

164)

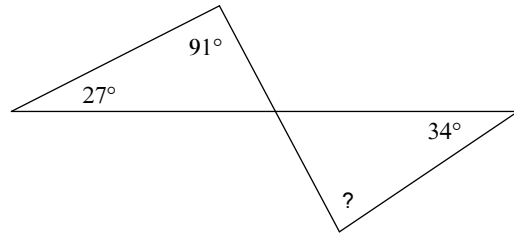

84°

165)

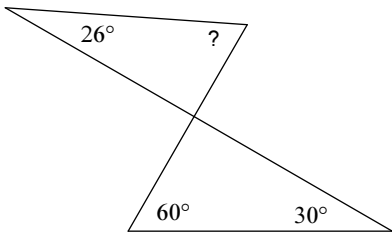

64°

166)

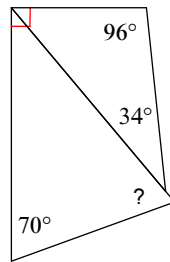

70°

167)

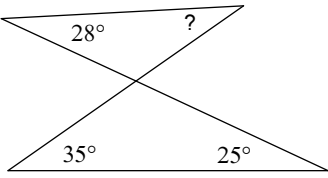

32°

168)

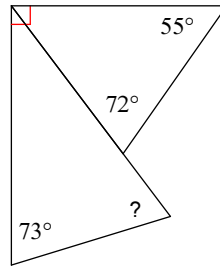

70°

169)

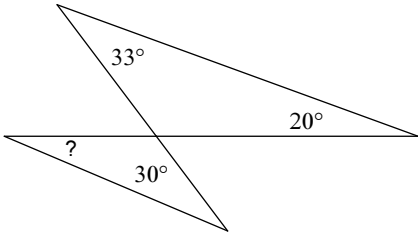

23°

170)

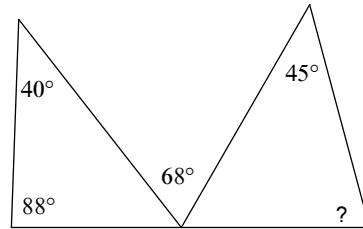

75°

171)

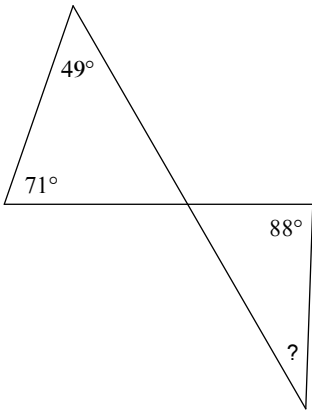

32°

172)

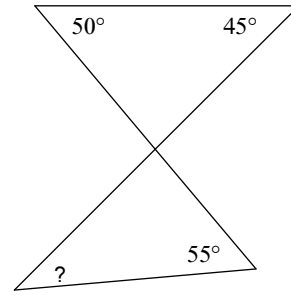

40°

173)

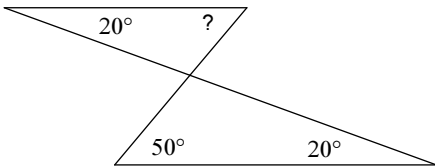

50°

174)

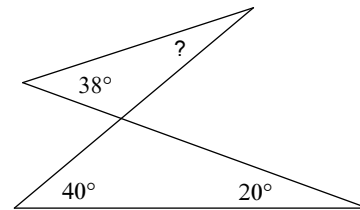

22°

175)

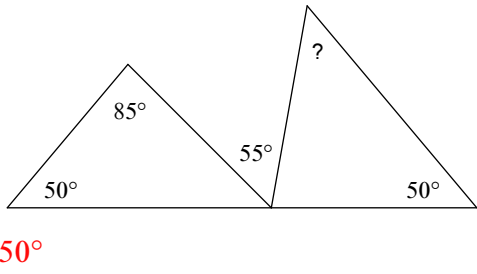

176)

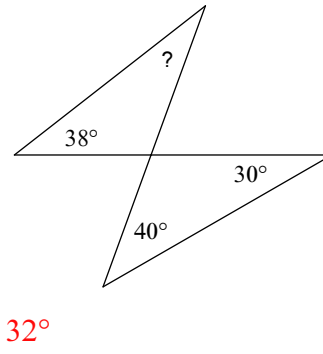

177)

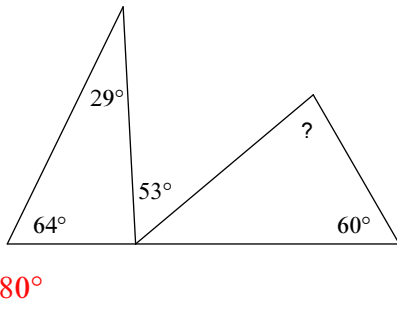

178)

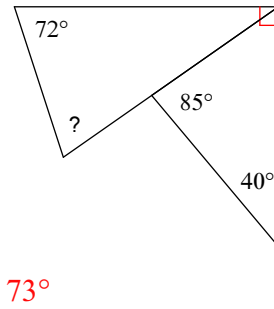

179)

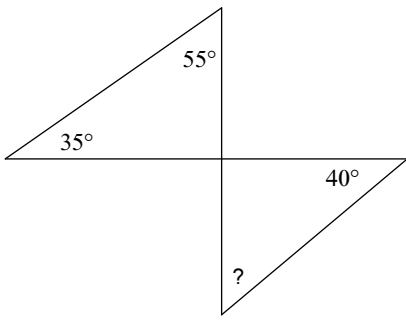

50°

180)

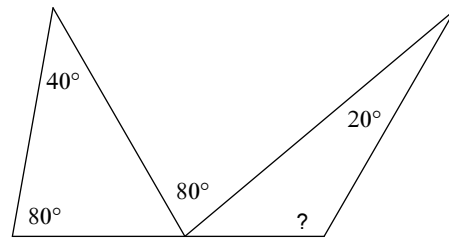

120°

181)

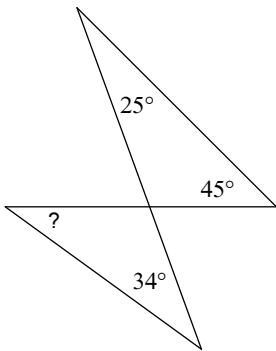

36°

182)

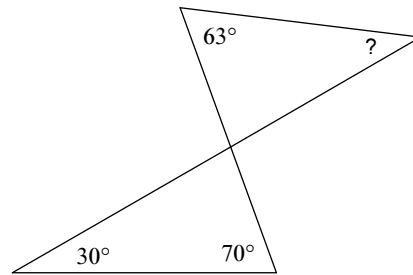

37°

183)

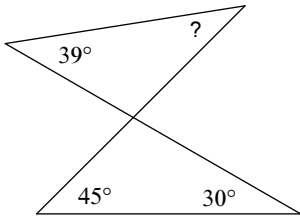

36°

184)

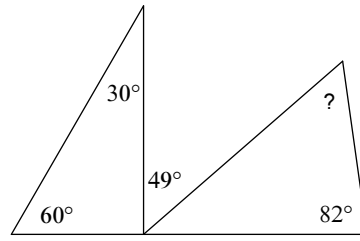

57°

185)

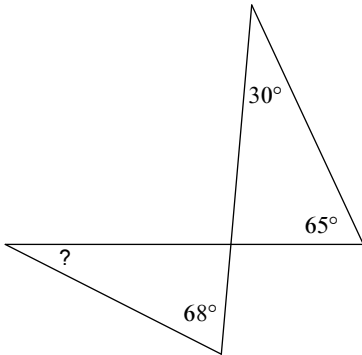

27°

186)

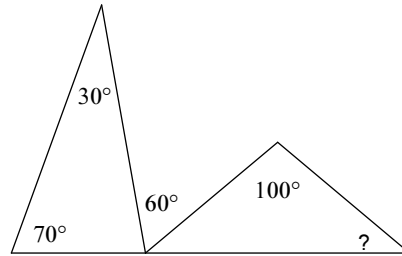

40°

187)

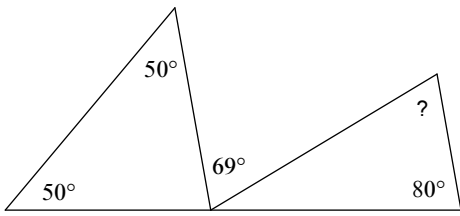

69°

188)

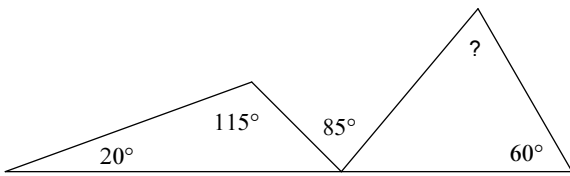

70°

189)

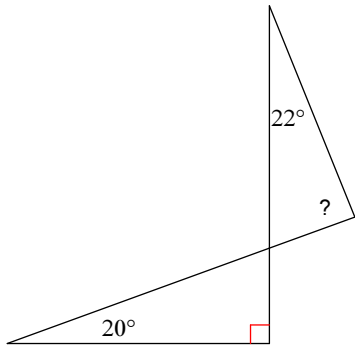

88°

190)

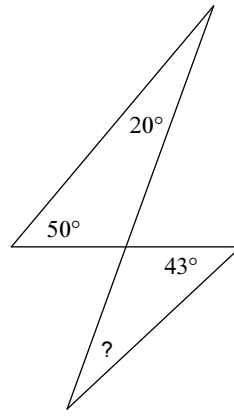

27°

191)

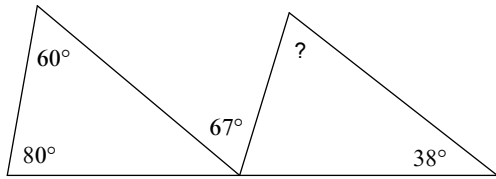

69°

192)

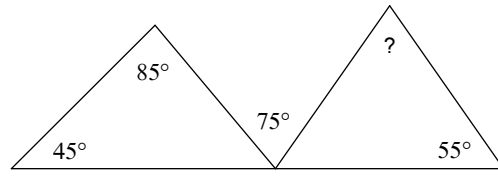

70°

193)

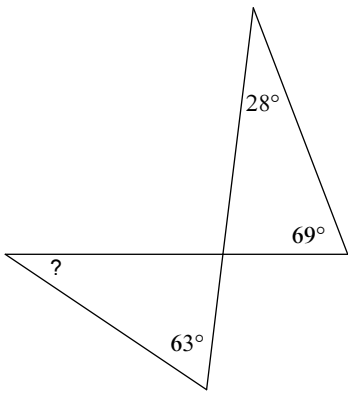

34°

194)

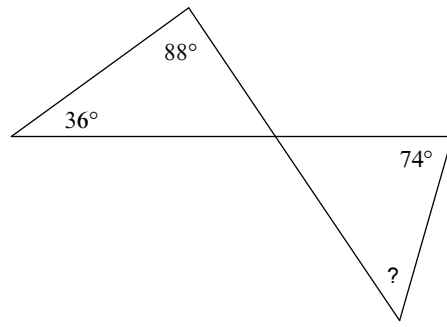

50°

195)

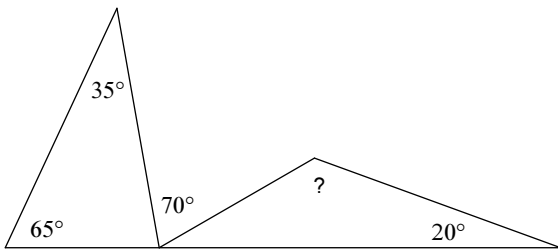

130°

196)

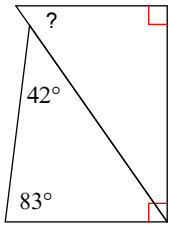

55°

197)

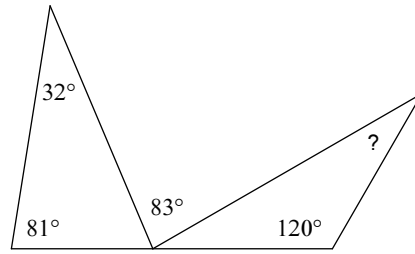

30°

198)

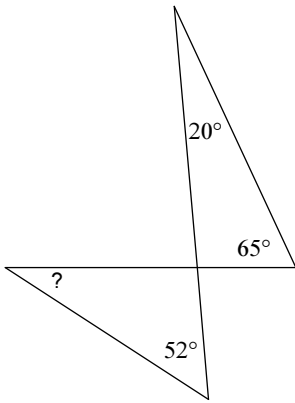

33°

199)

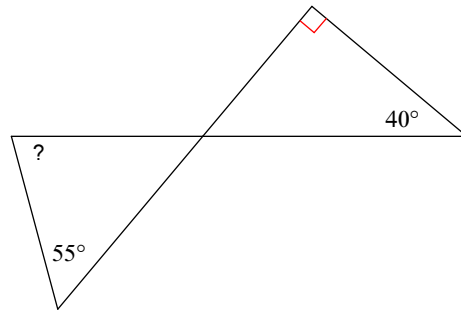

75°

200)

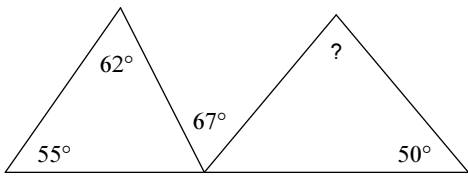

80°

201)

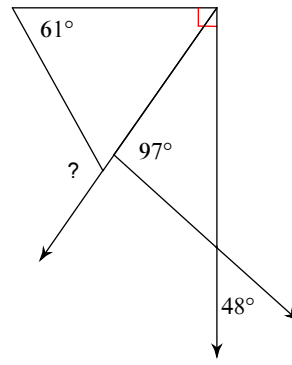

116°

202)

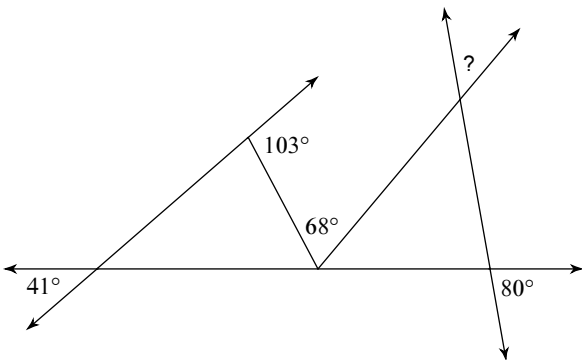

50°

203)

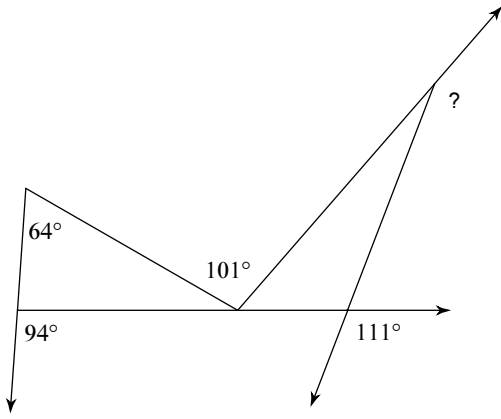

160°

204)

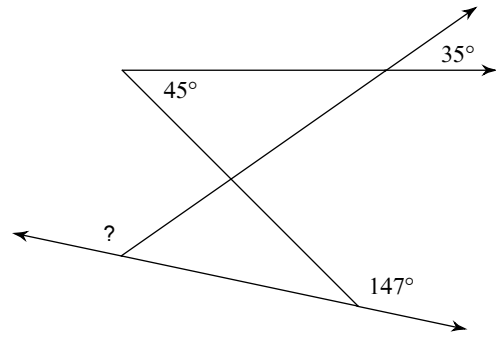

133°

205)

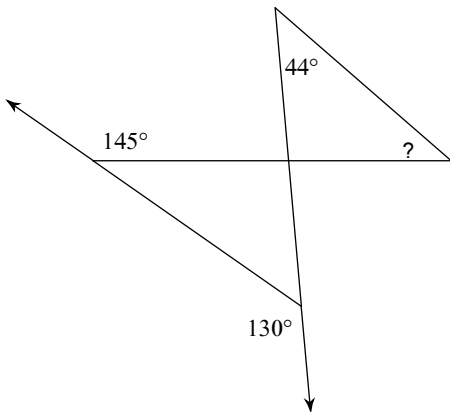

41°

206)

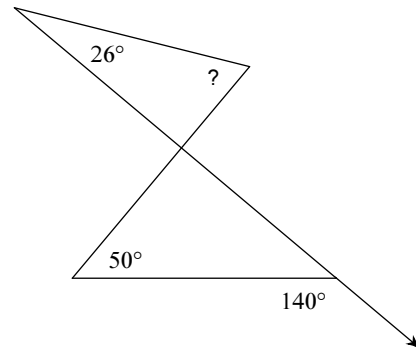

64°

207)

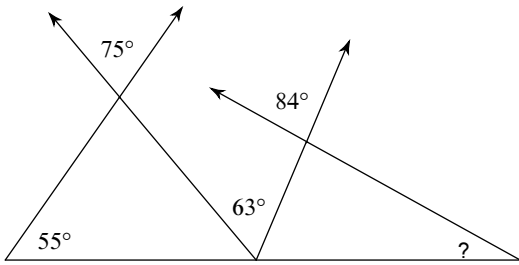

29°

208)

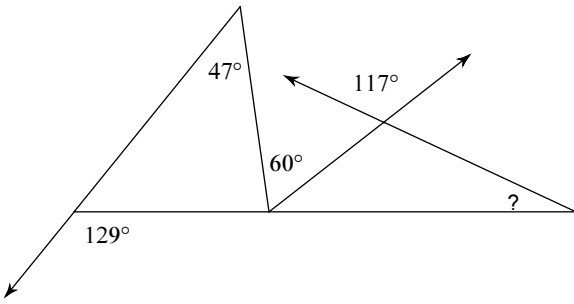

25°

209)

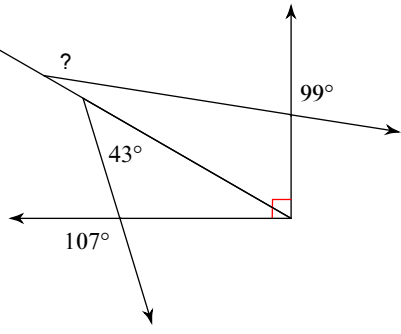

159°

210)

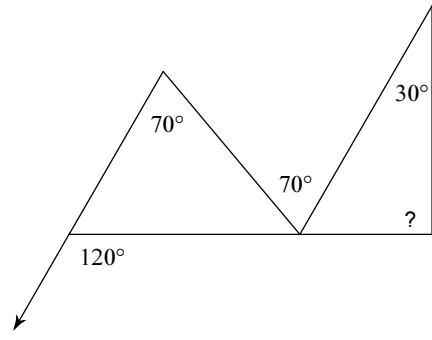

90°

211)

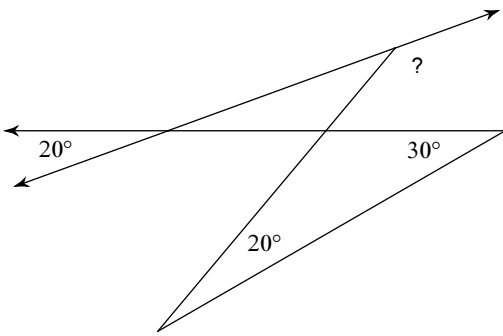

150°

212)

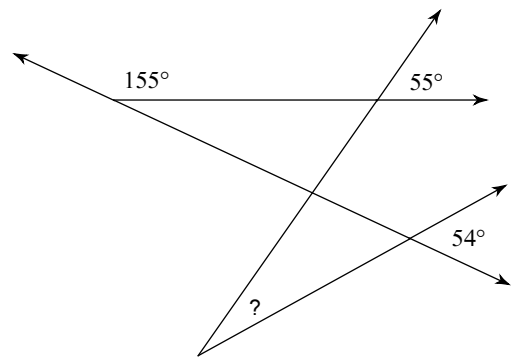

26°

213)

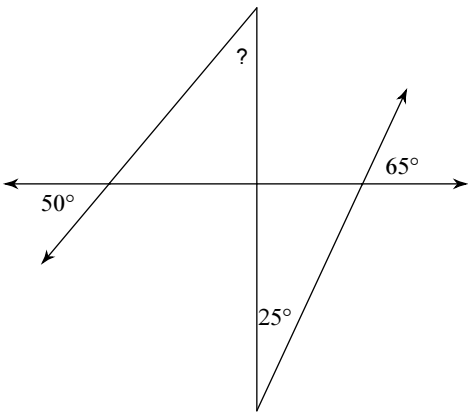

40°

214)

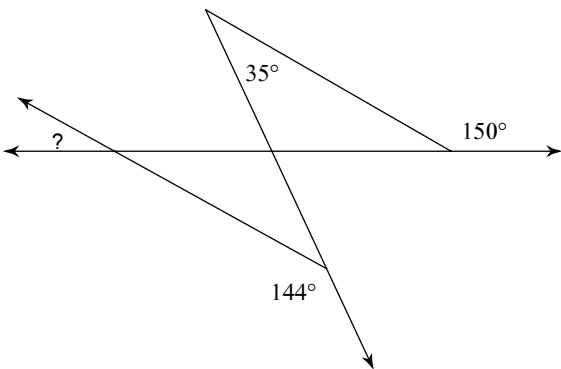

29°

215)

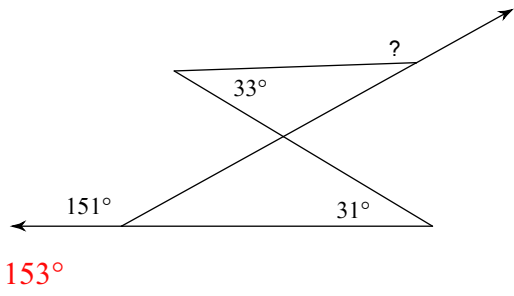

216)

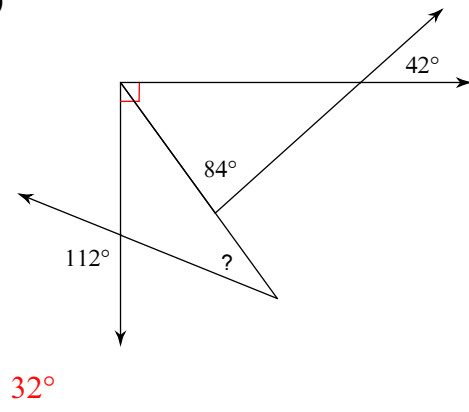

217)

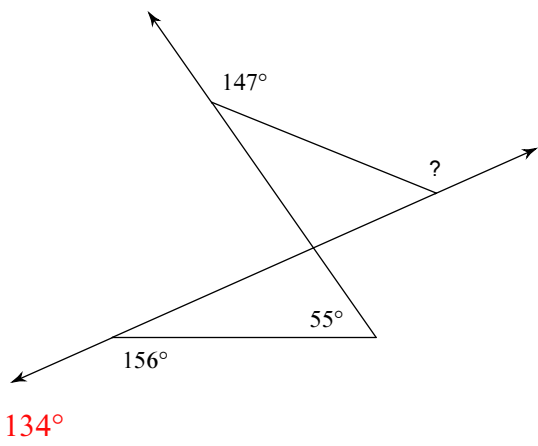

218)

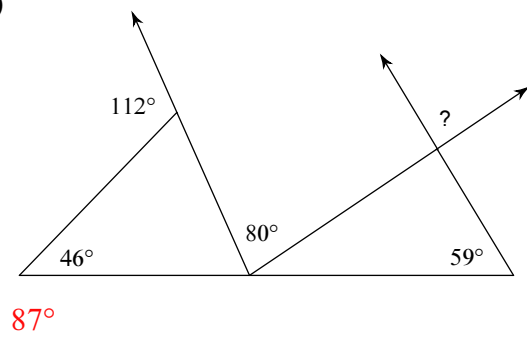

219)

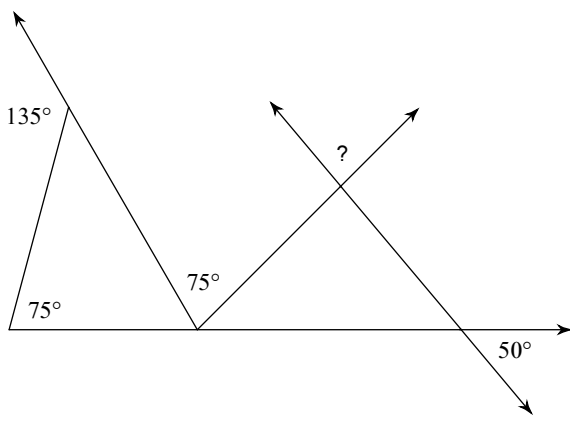

85°

220)

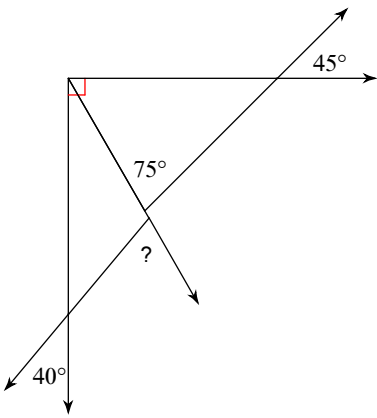

70°

221)

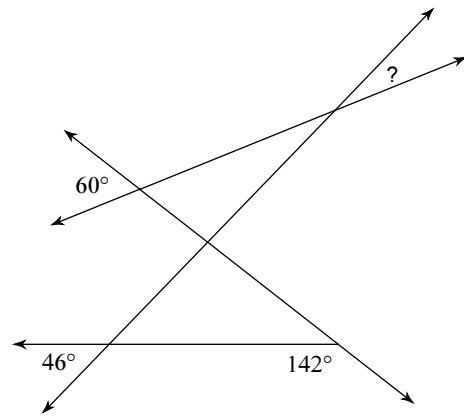

24°

222)

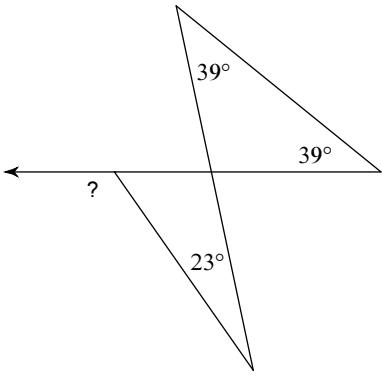

125°

223)

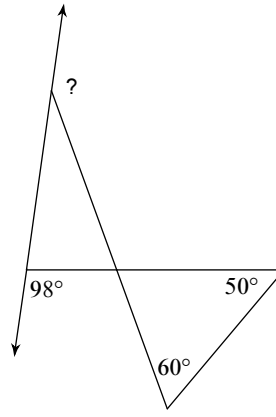

152°

224)

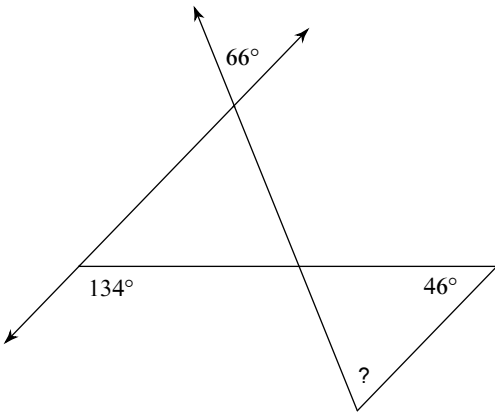

66°

225)

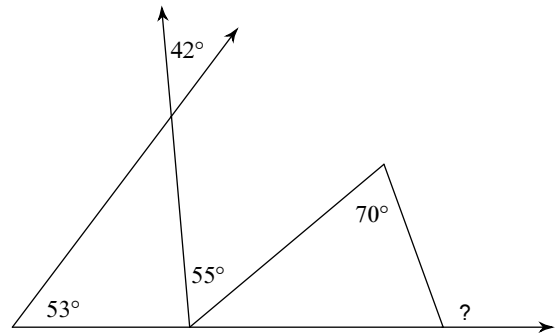

110°

226)

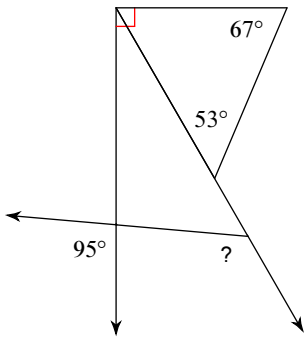

125°

227)

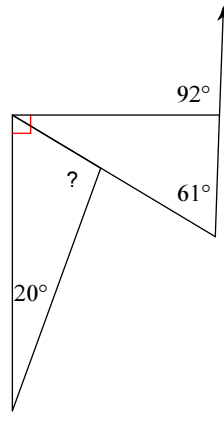

101°

228)

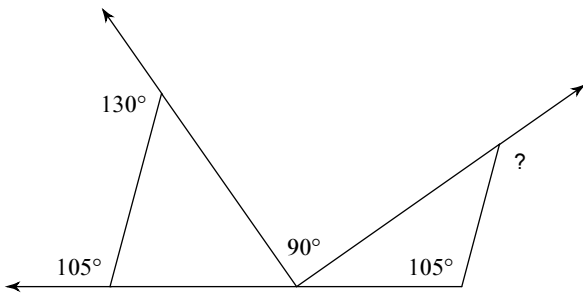

140°

229)

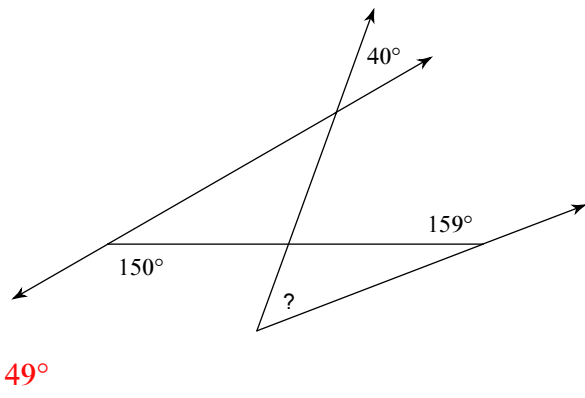

230)

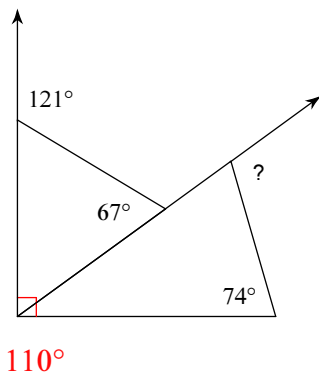

231)

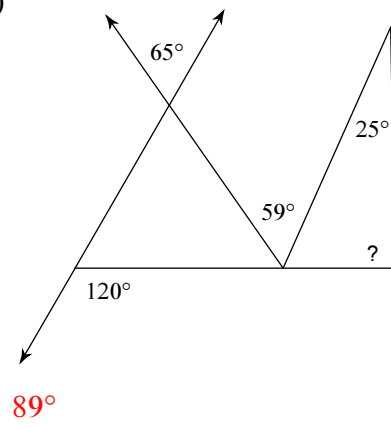

232)

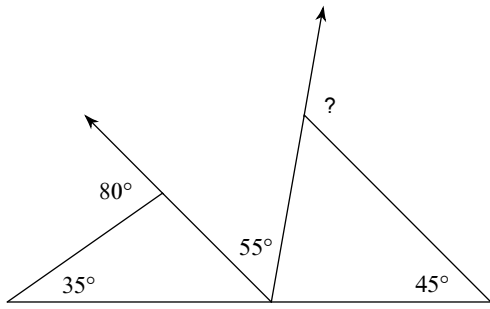

125°

233)

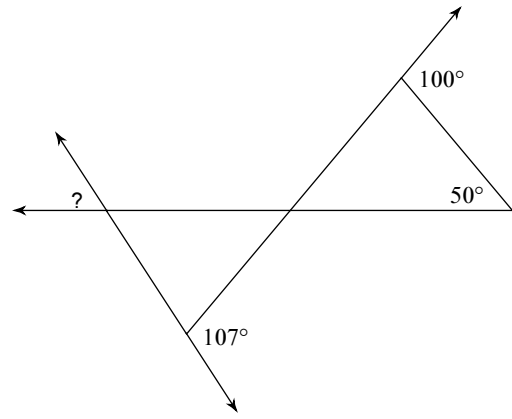

57°

234)

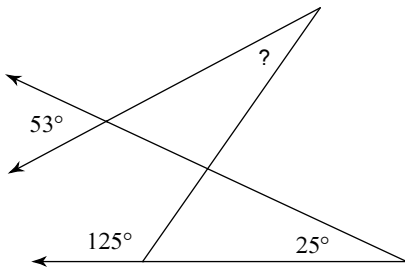

27°

235)

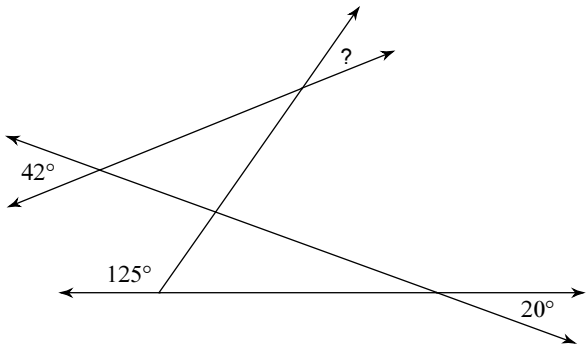

33°

236)

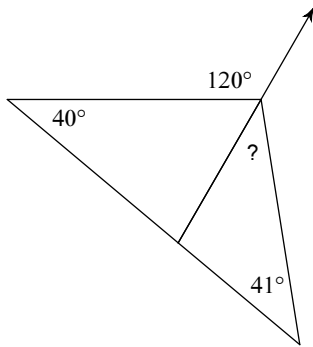

39°

237)

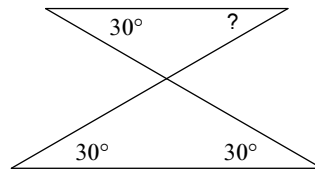

30°

238)

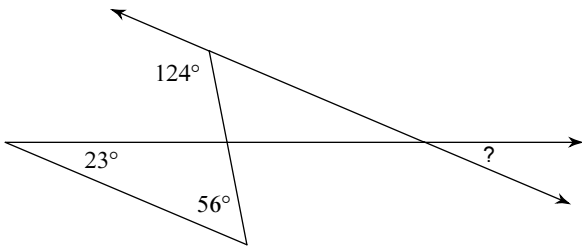

23°

239)

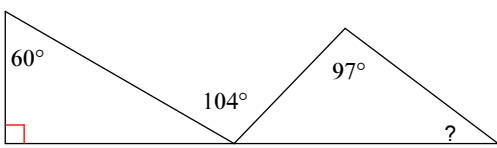

37°

240)

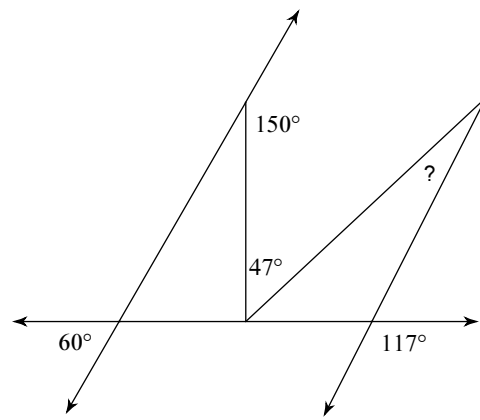

20°

241)

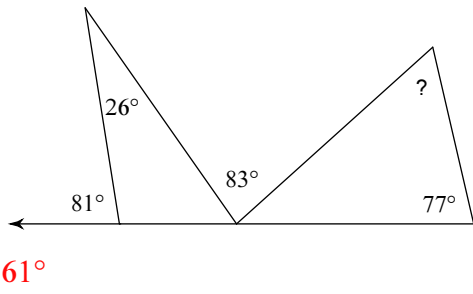

242)

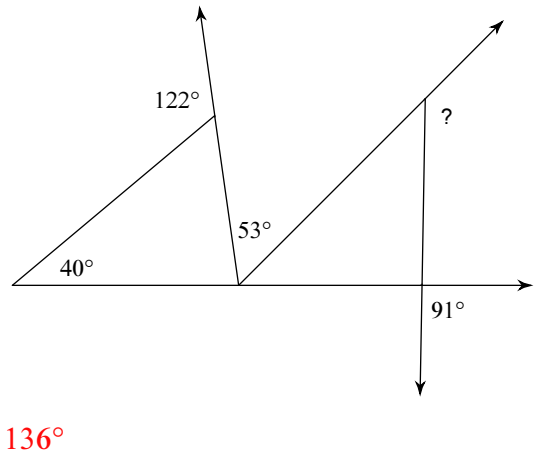

243)

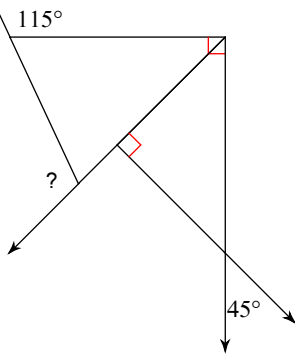

244)

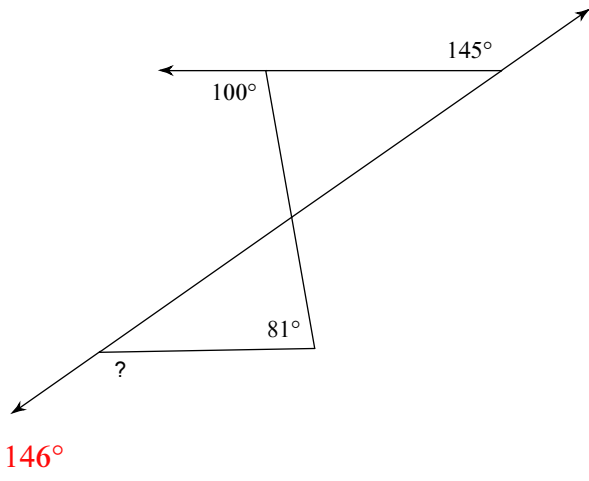

245)

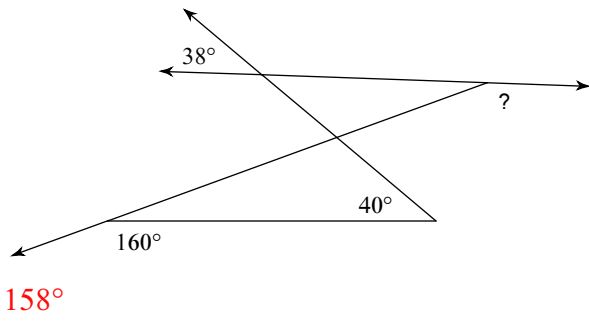

246)

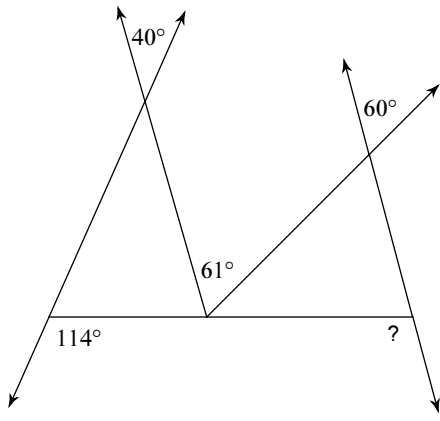

105°

247)

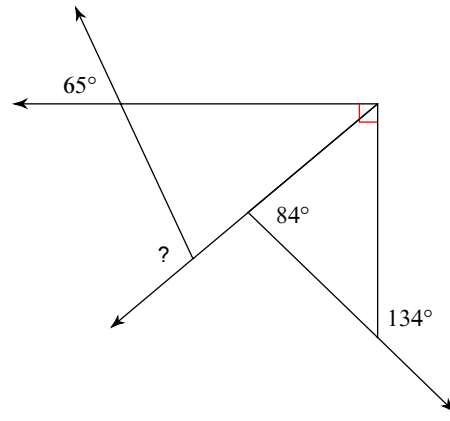

105°

248)

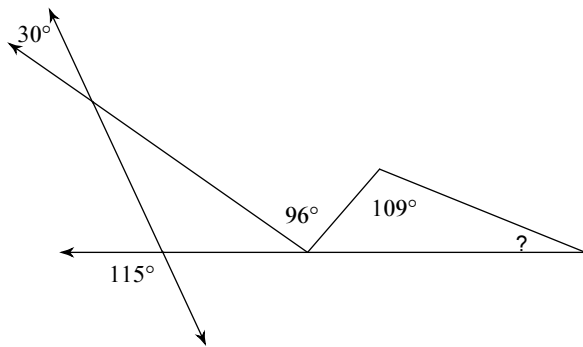

22°

249)

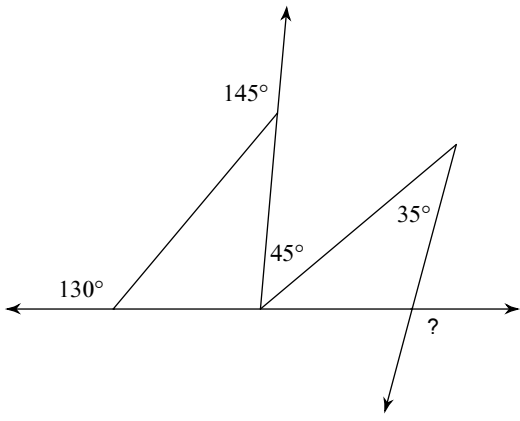

105°

250)

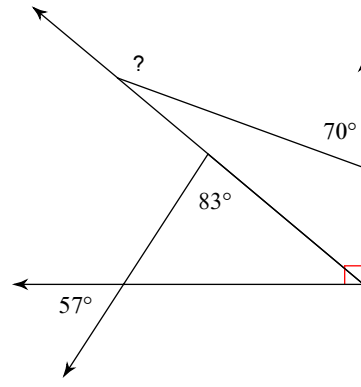

160°

251)

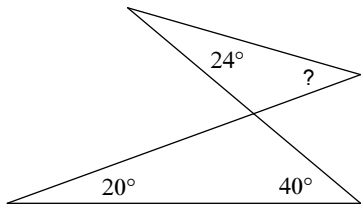

36°

252)

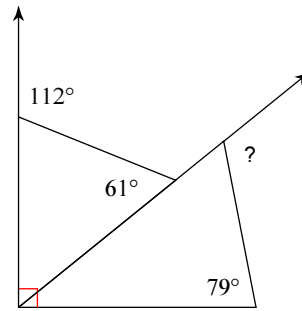

118°

253)

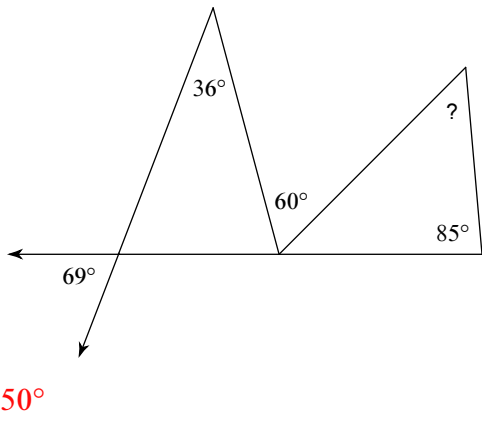

254)

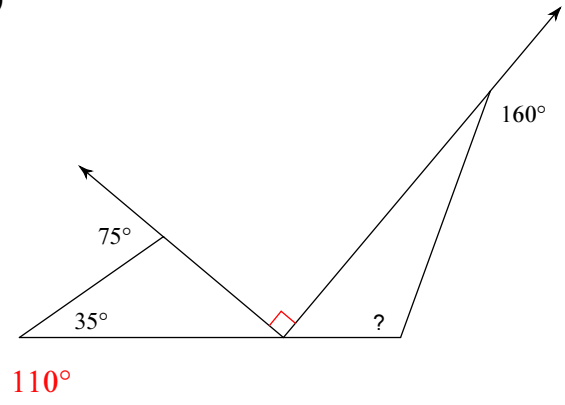

255)

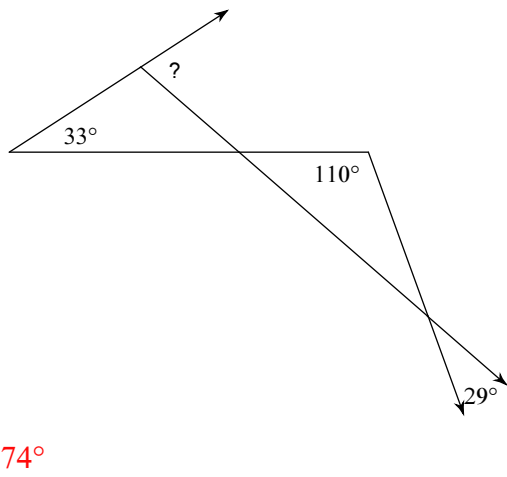

256)

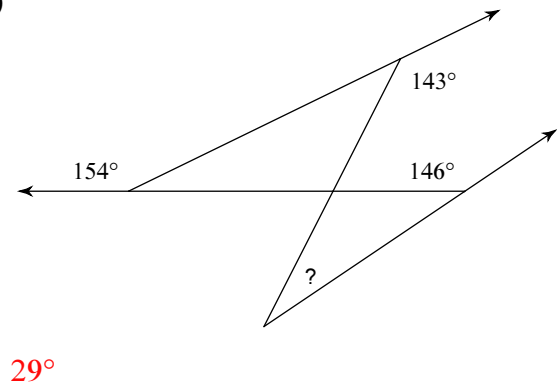

257)

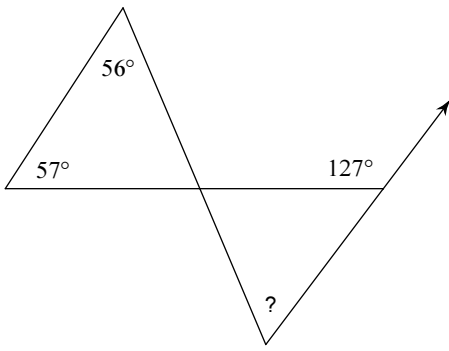

60°

258)

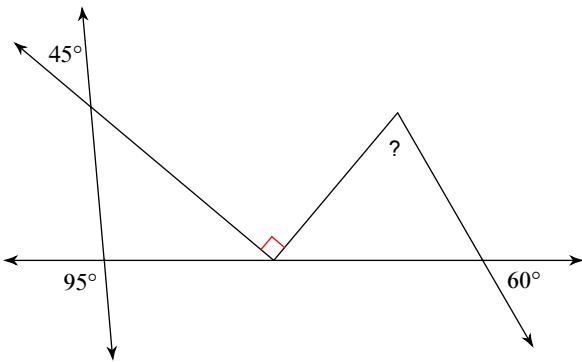

70°

259)

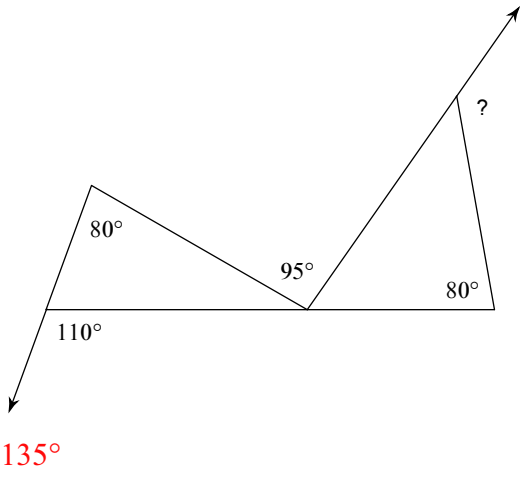

260)

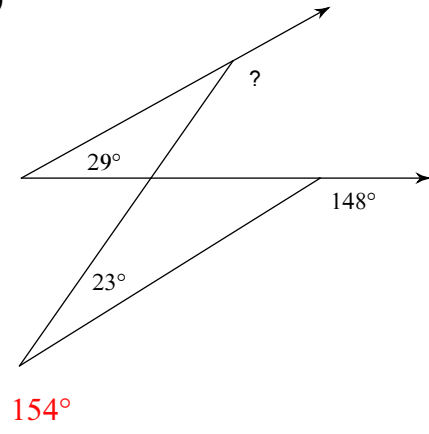

261)

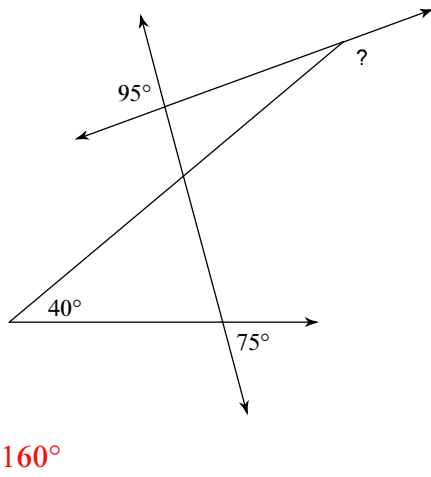

262)

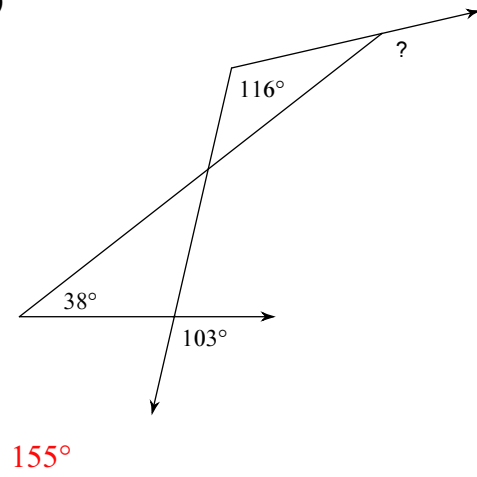

263)

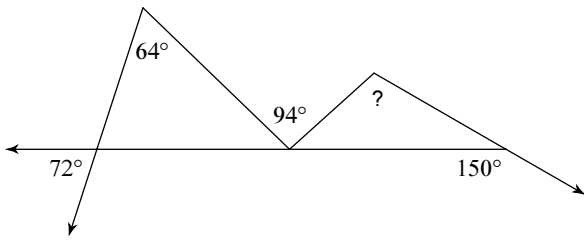

108°

264)

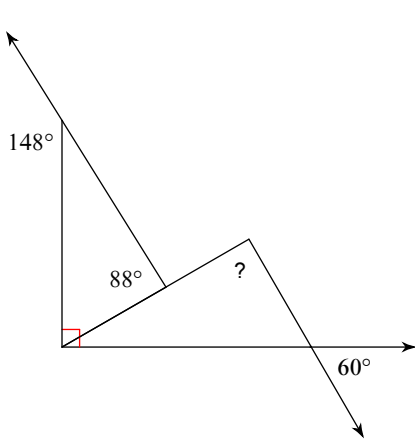

90°

265)

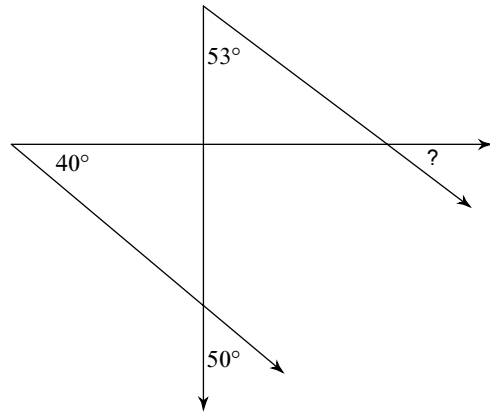

37°

266)

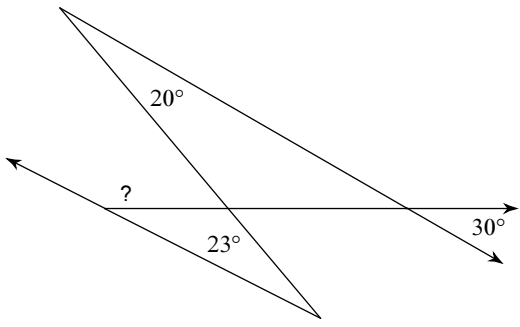

153°

267)

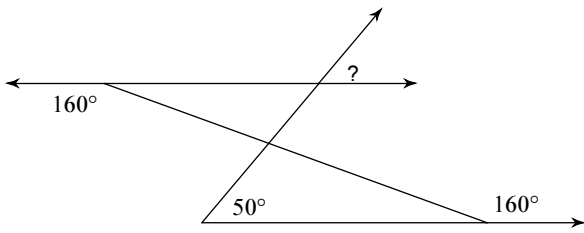

50°

268)

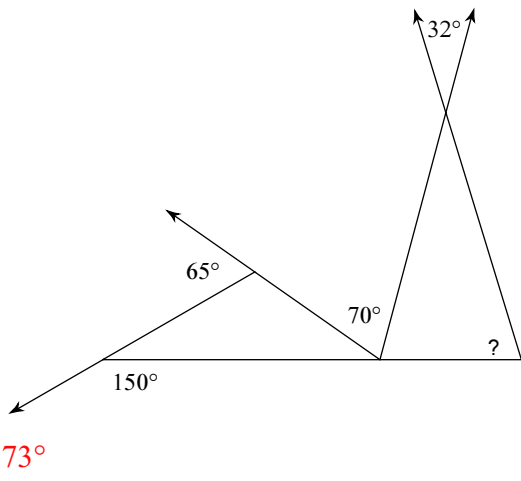

269)

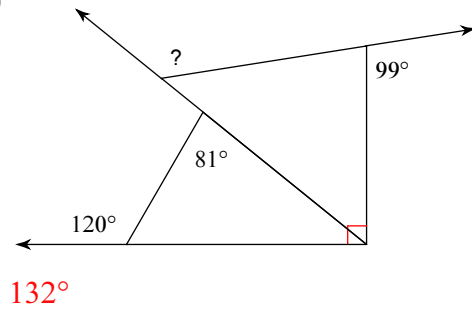

270)

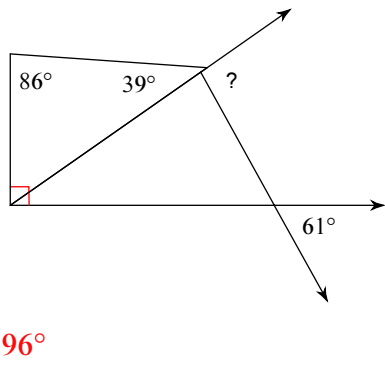

271)

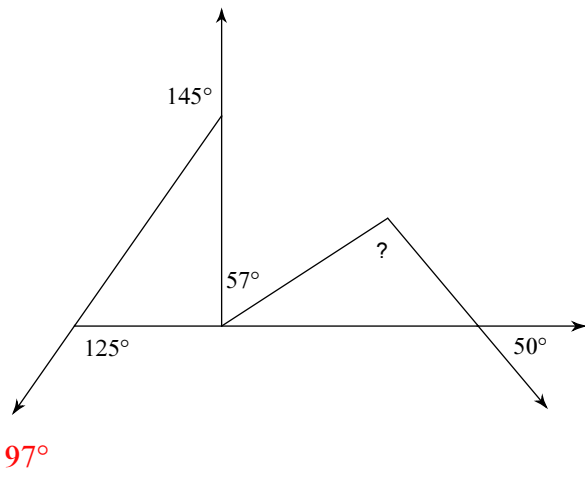

272)

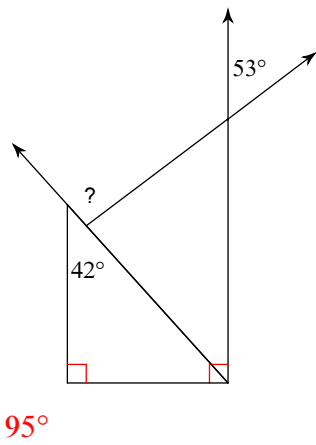

273)

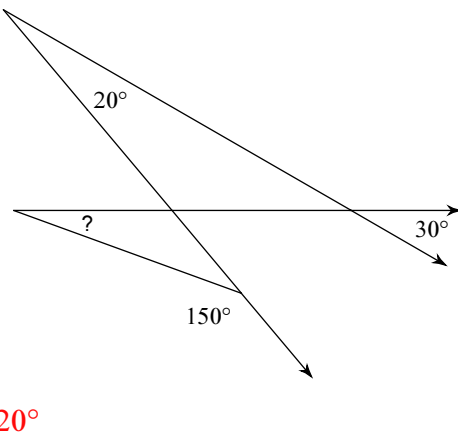

274)

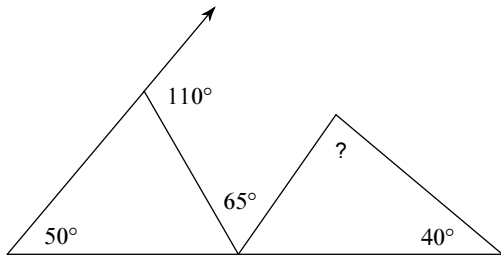

85°

275)

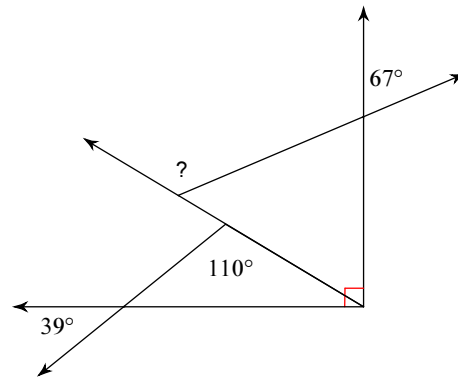

126°

276)

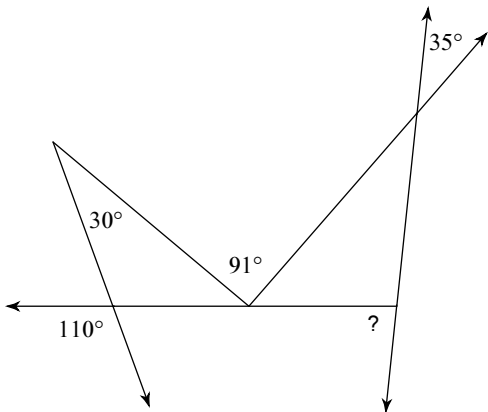

84°

277)

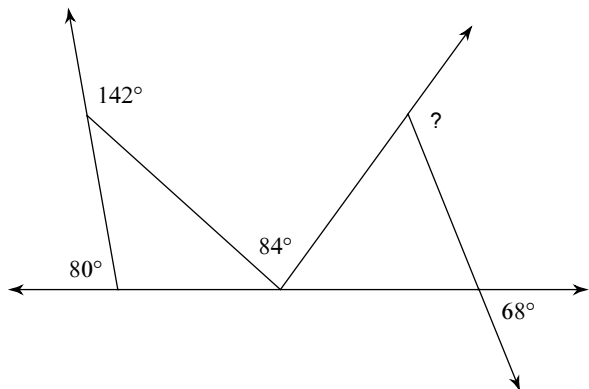

122°

278)

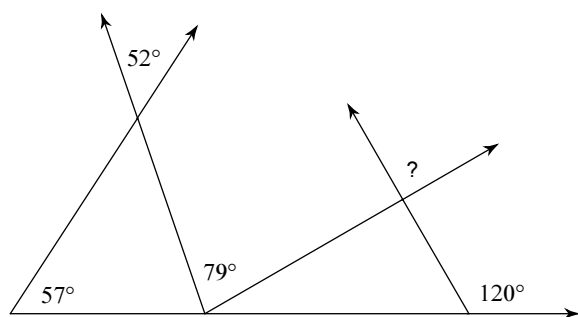

90°

279)

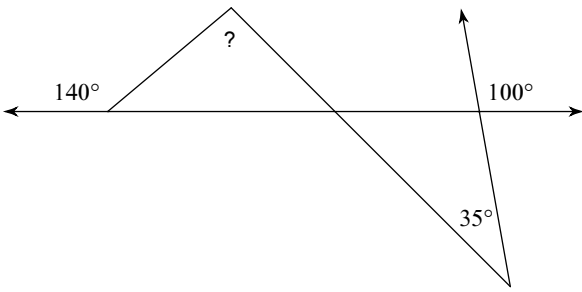

95°

280)

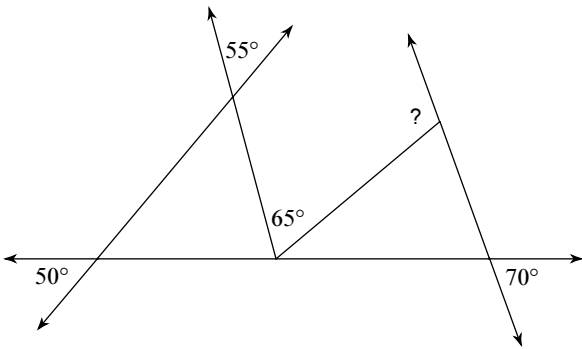

110°

281)

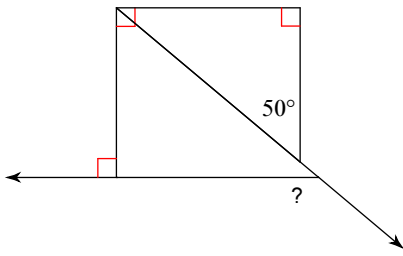

140°

282)

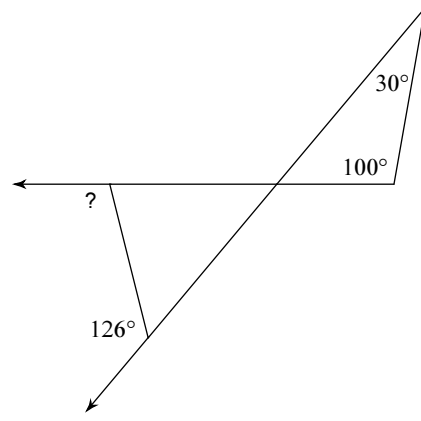

104°

283)

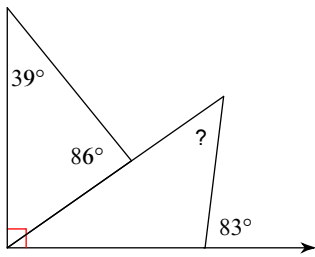

48°

284)

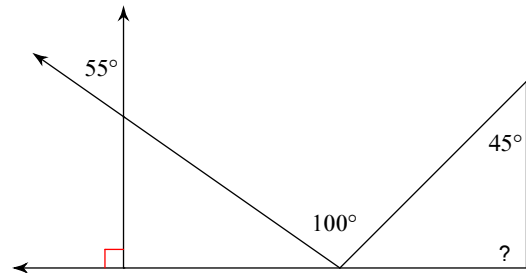

90°

285)

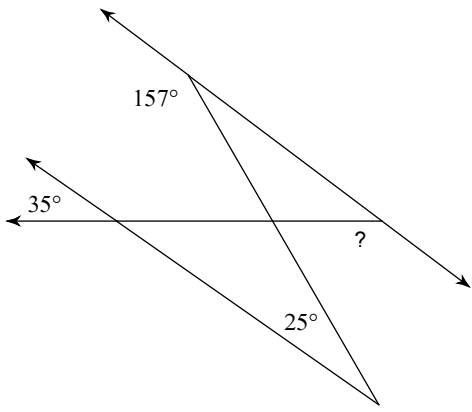

143°

286)

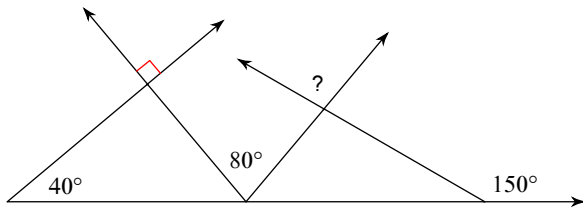

100°

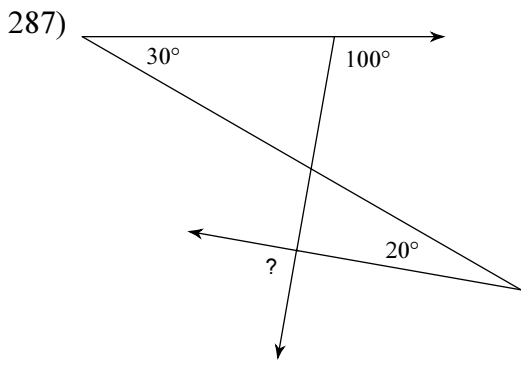

90°

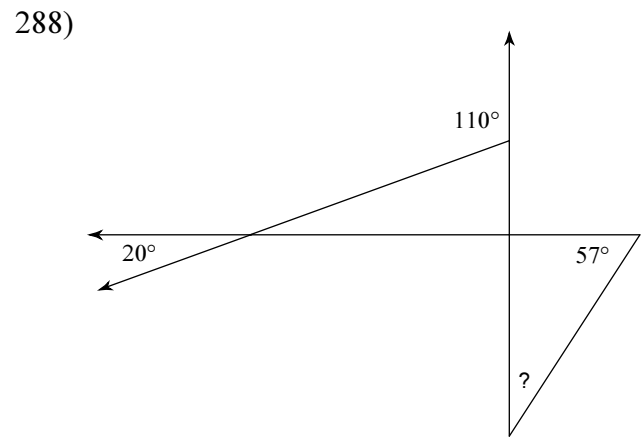

33°

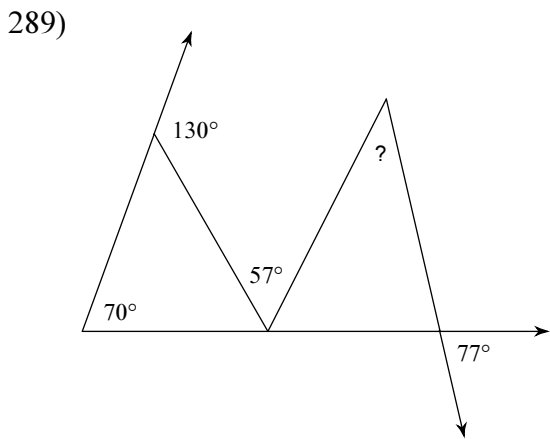

40°

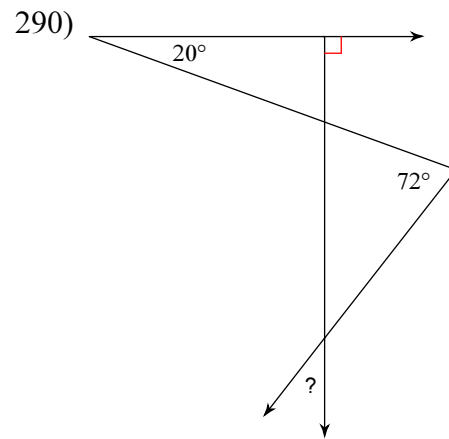

38°

291)

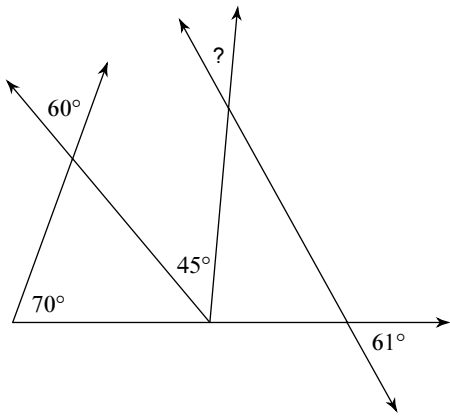

34°

292)

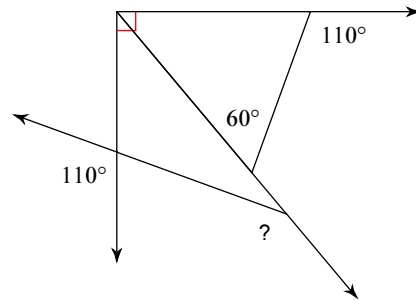

150°

293)

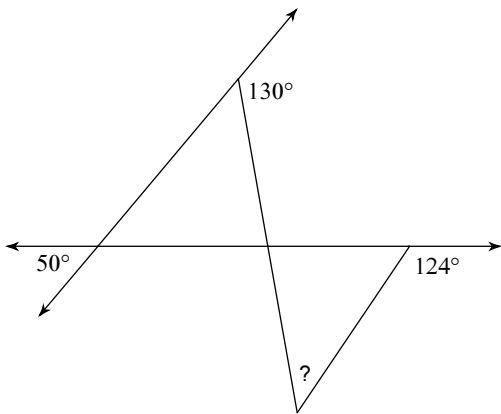

44°

294)

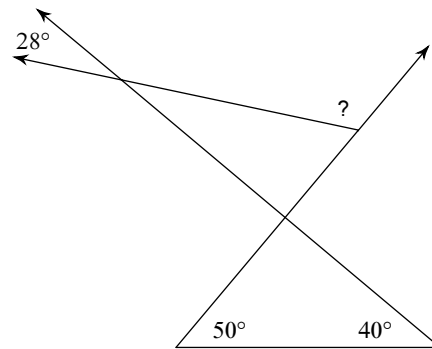

118°

295)

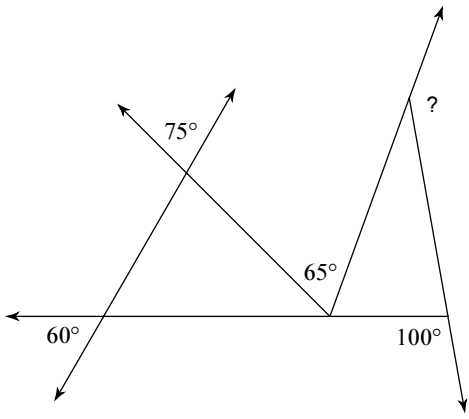

150°

296)

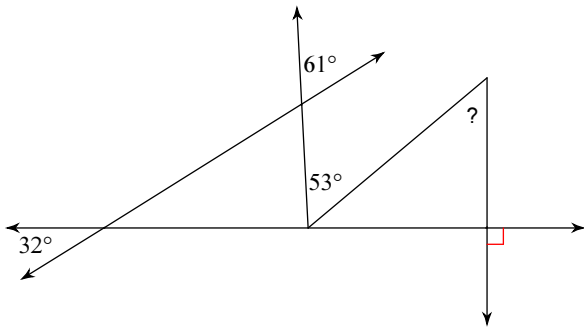

50°

297)

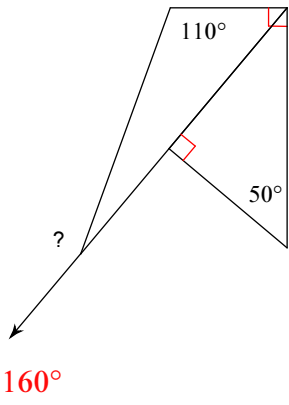

298)

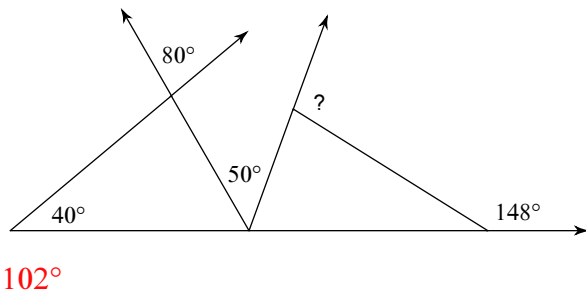

299)

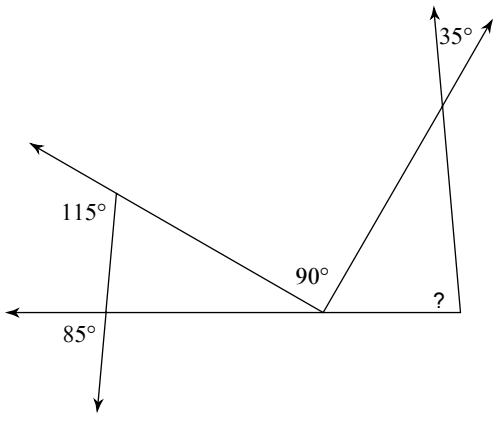

85°

300)

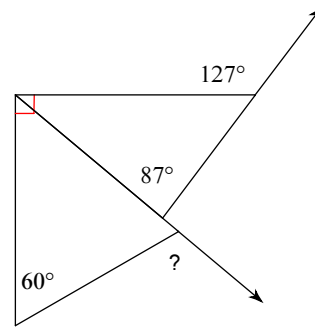

110°

301)

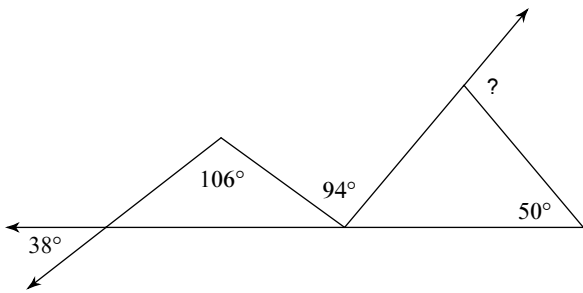

100°

302)

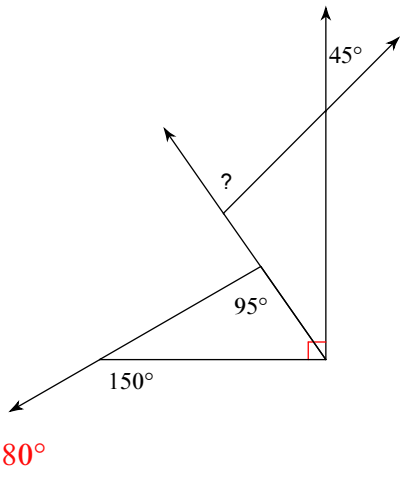

303)

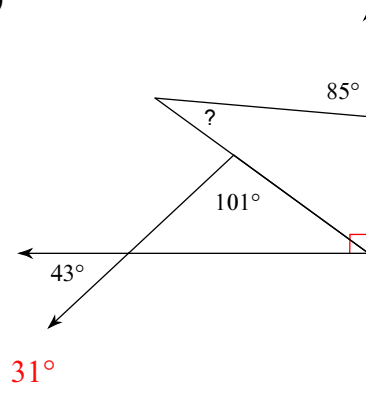

304)

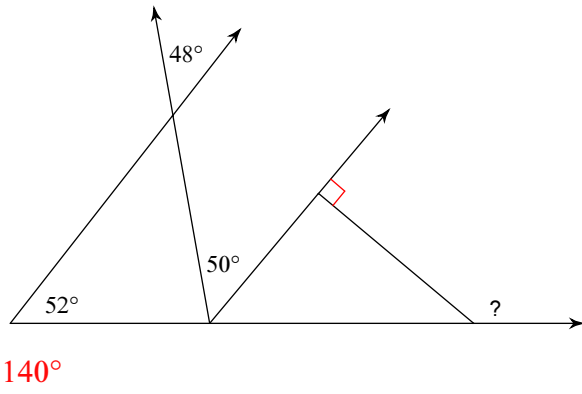

305)

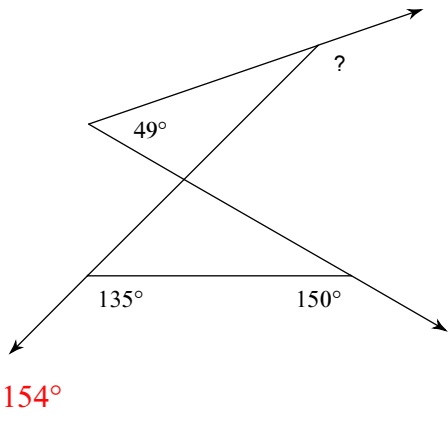

306)

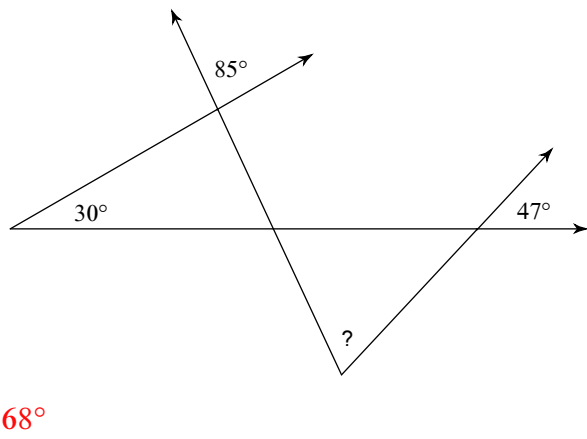

307)

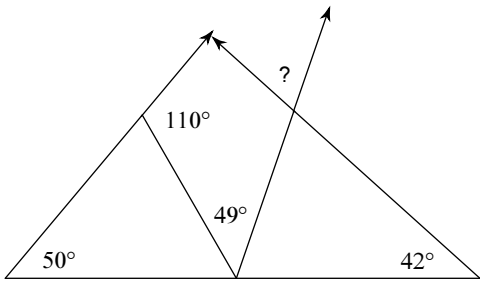

67°

308)

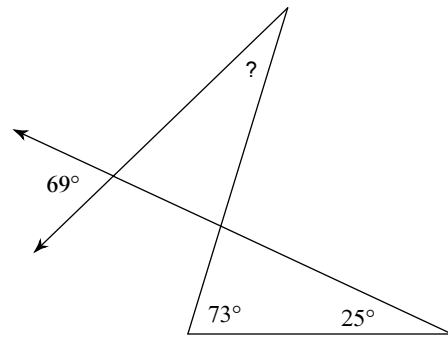

29°

309)

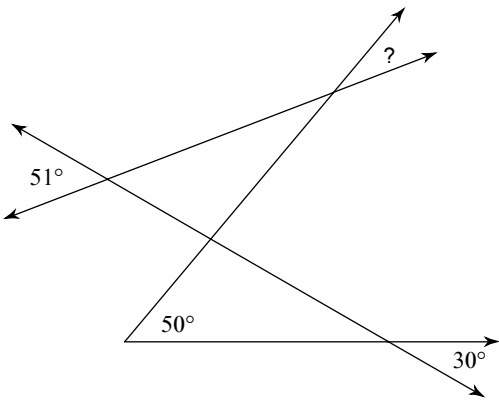

29°

310)

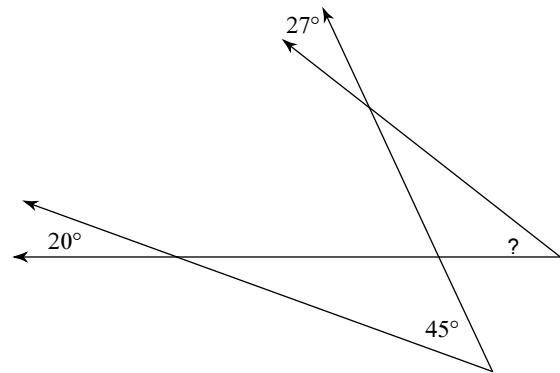

38°

311)

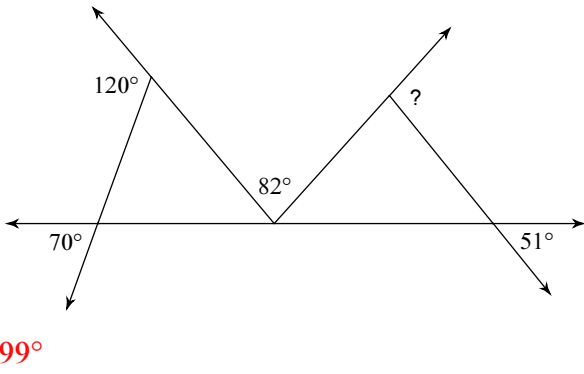

312)

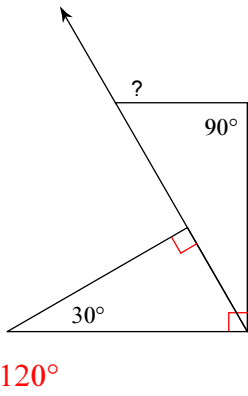

313)

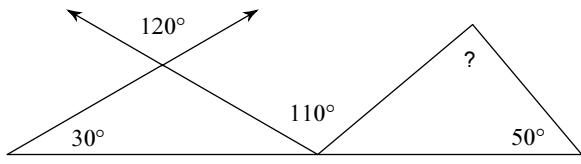

90°

314)

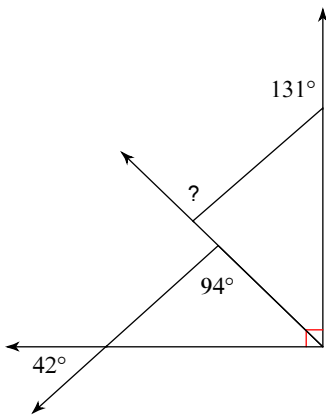

95°

315)

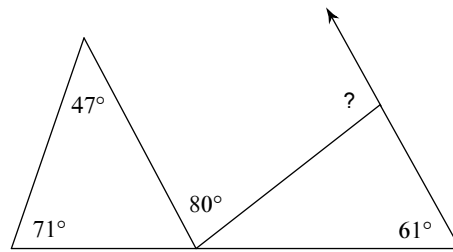

99°

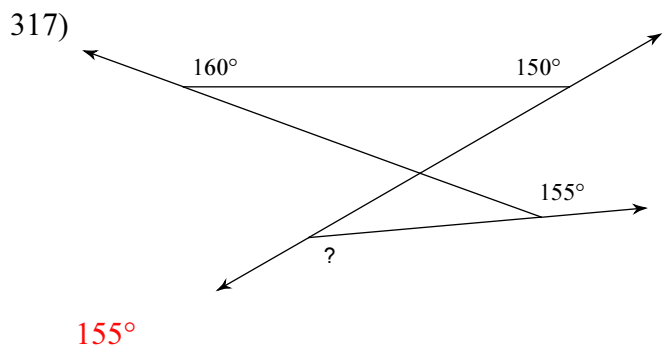
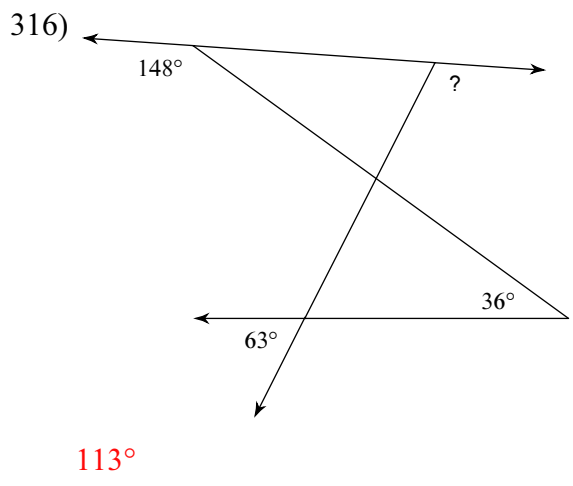

318)

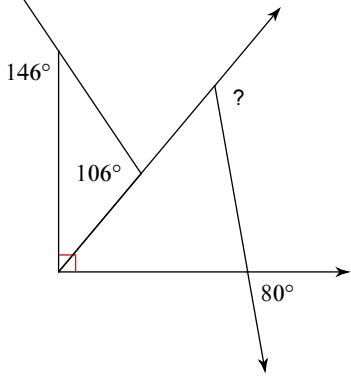

130°

319)

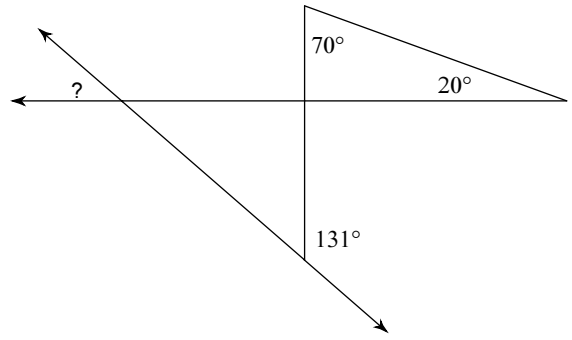

41°

320)

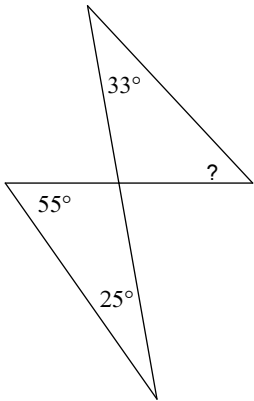

47°

321)

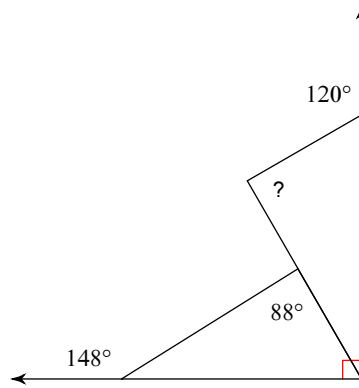

90°

322)

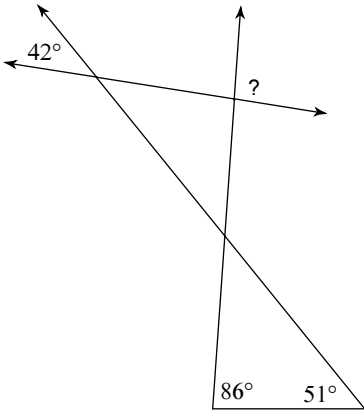

95°

323)

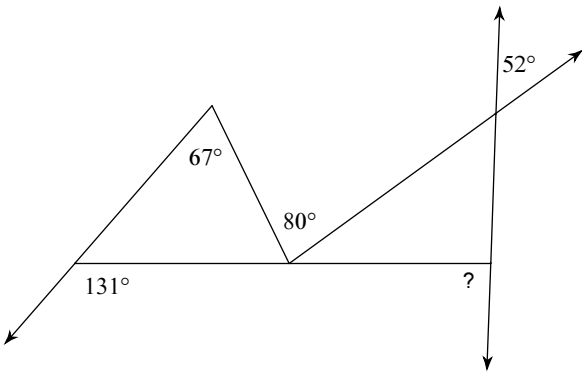

88°

324)

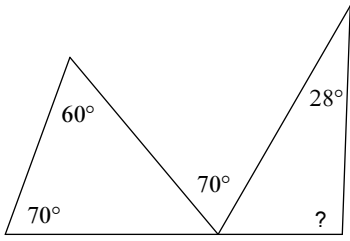

92°

325)

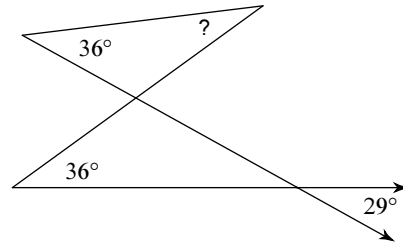

29°

326)

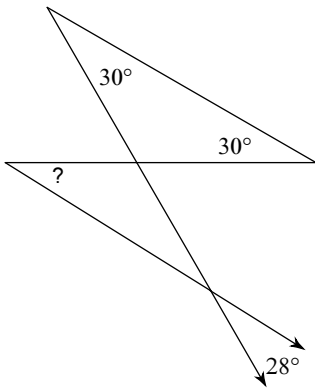

32°

327)

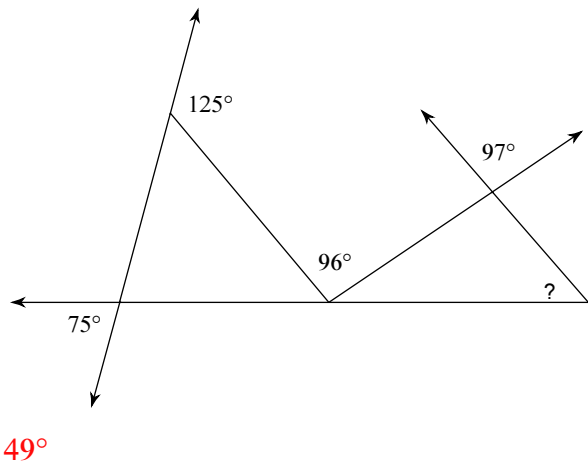

328)

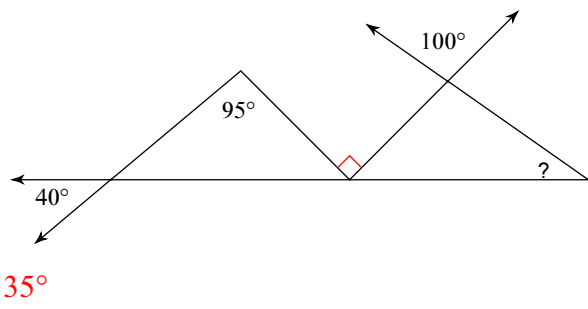

329)

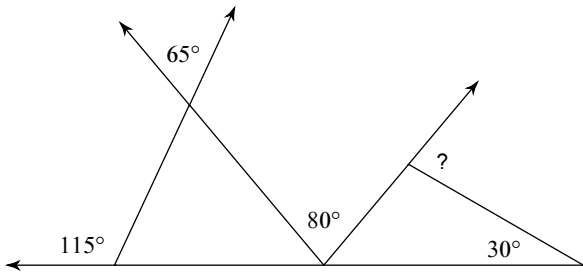

80°

330)

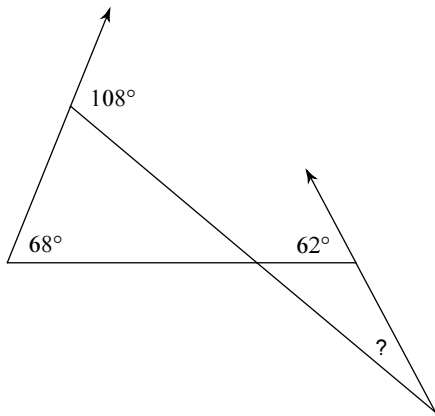

22°

331)

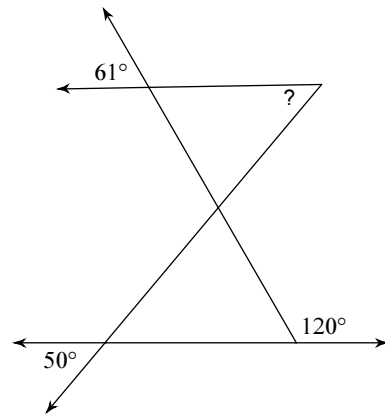

49°

332)

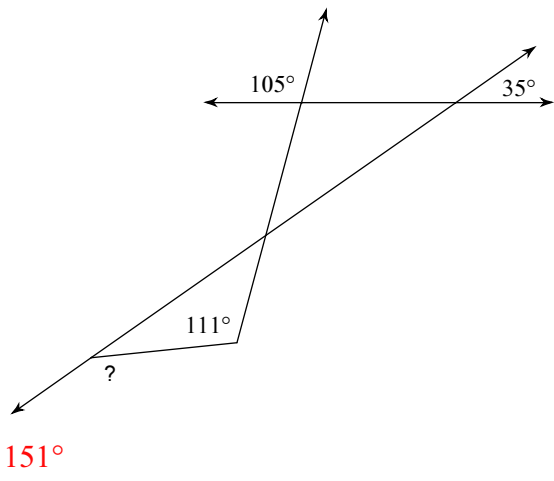

333)

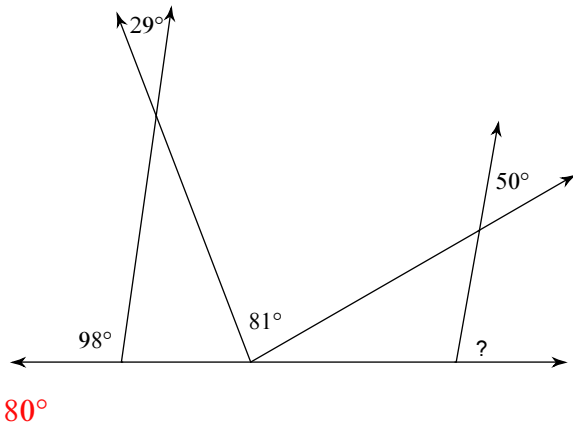

334)

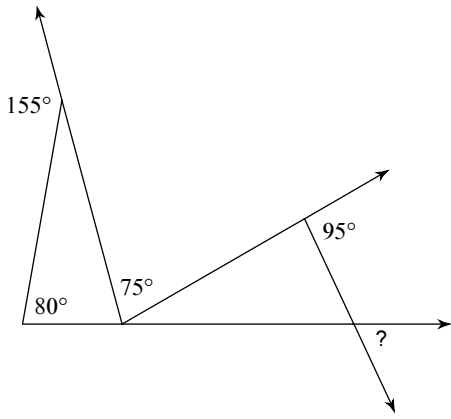

65°

335)

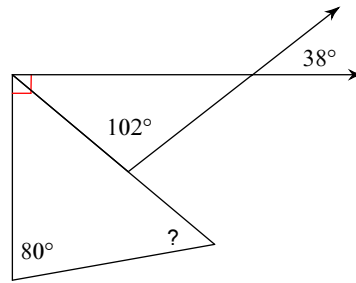

50°

336)

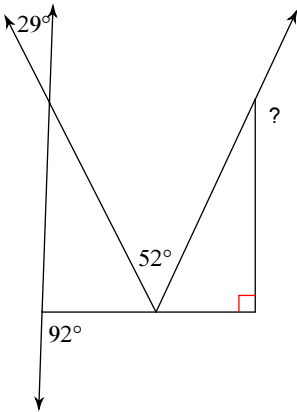

155°

337)

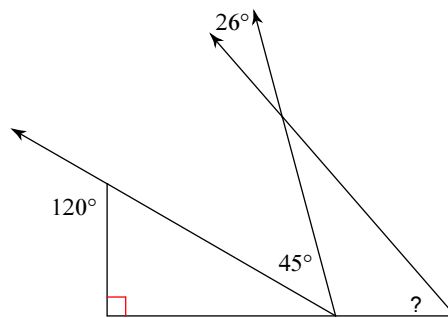

49°

338)

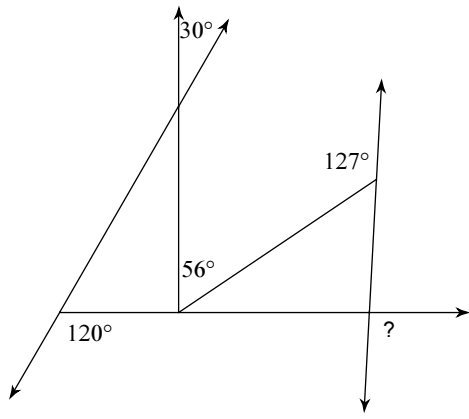

93°

339)

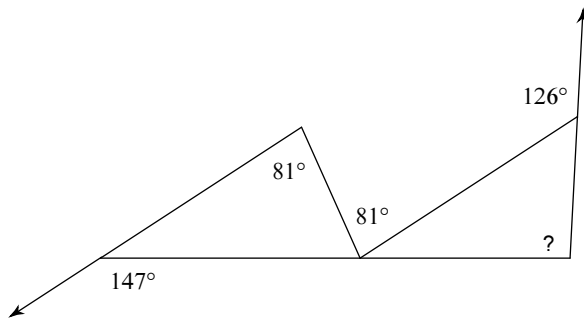

93°

340)

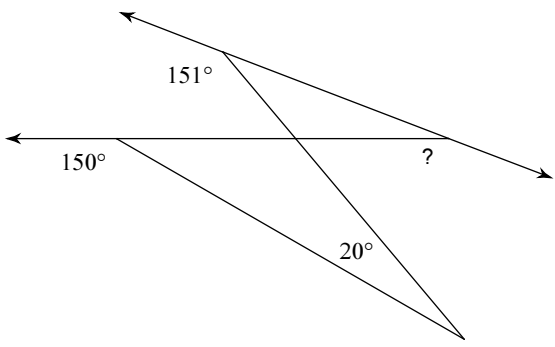

159°

341)

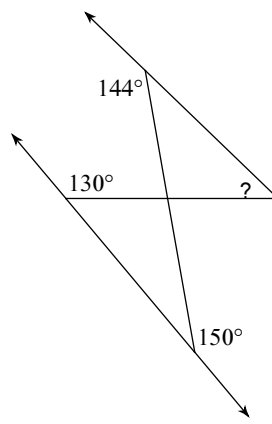

44°

342)

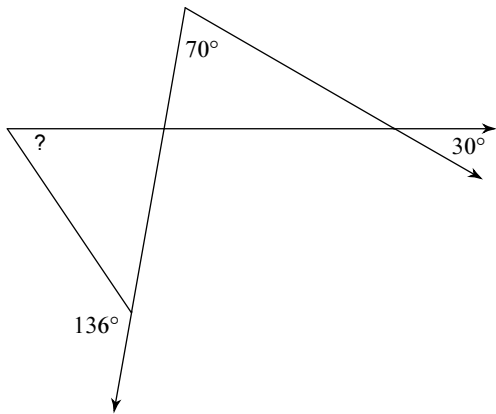

56°

343)

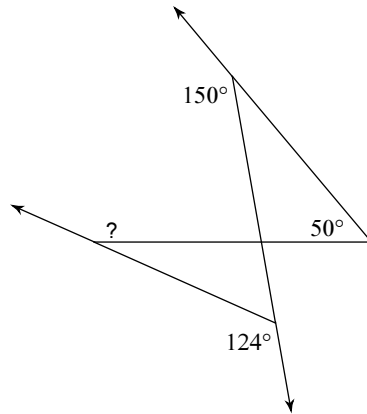

156°

344)

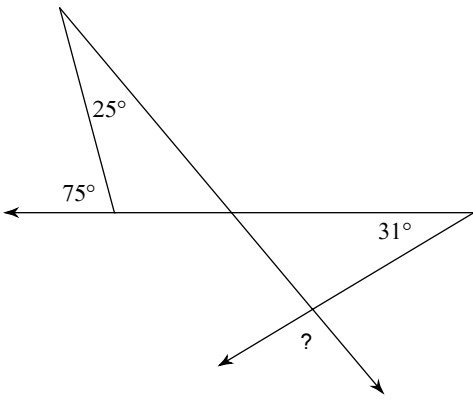

99°

345)

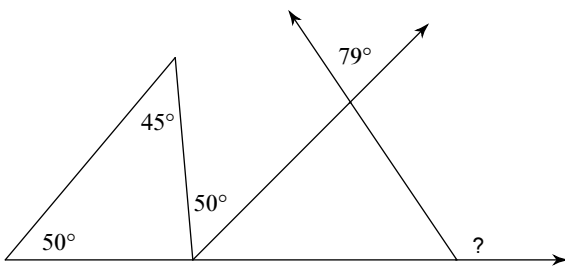

124°

346)

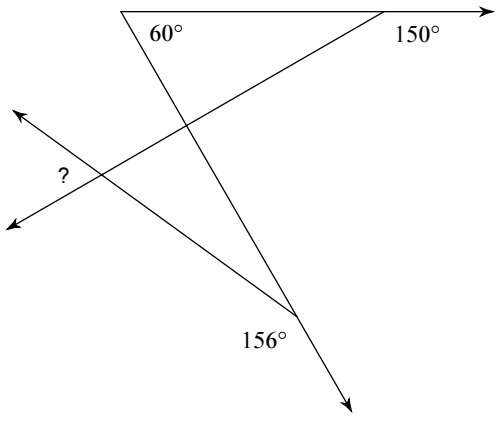

66°

347)

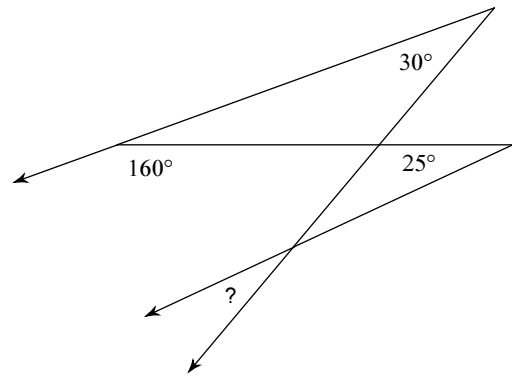

25°

348)

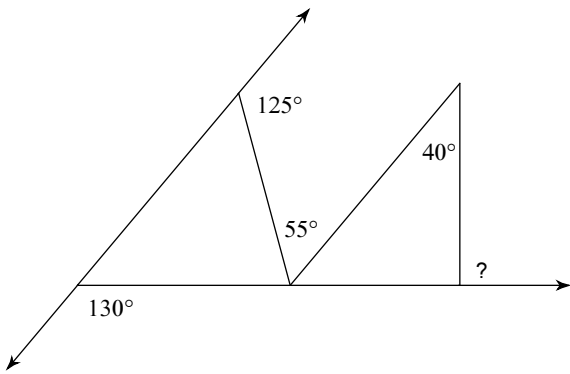

90°

349)

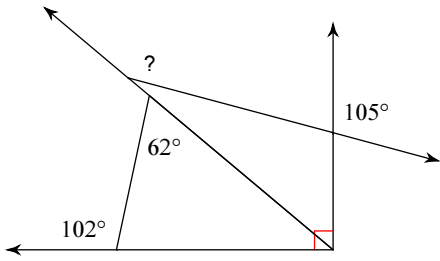

155°

350)

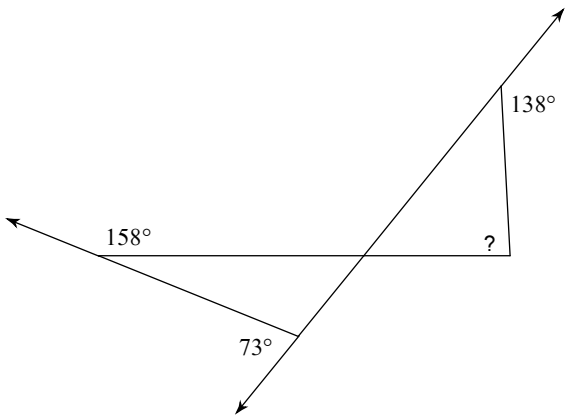

87°

351)

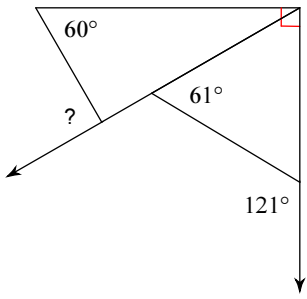

90°

352)

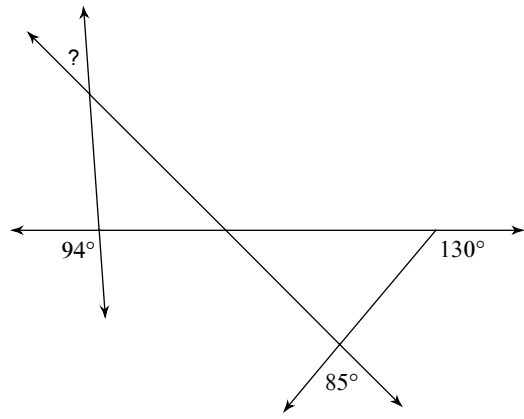

41°

353)

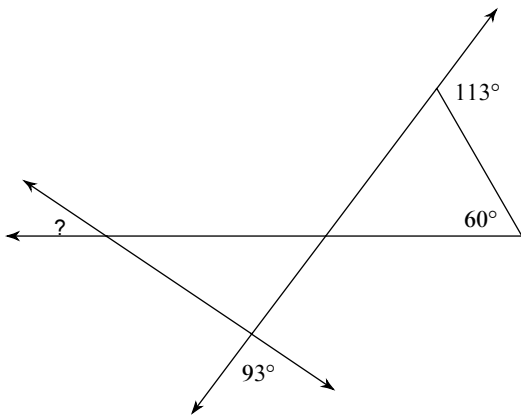

34°

354)

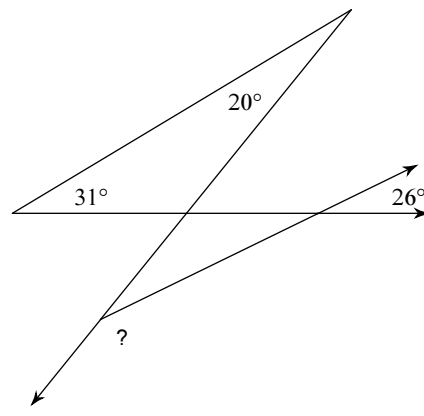

155°

355)

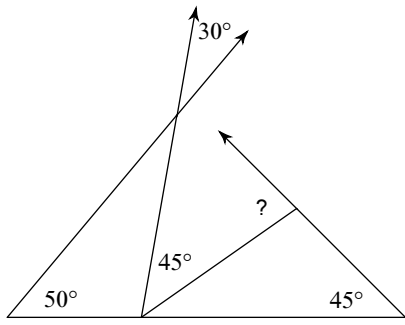

80°

356)

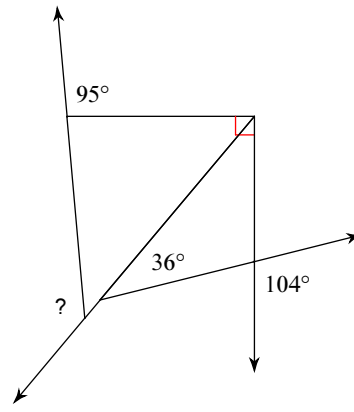

135°

357)

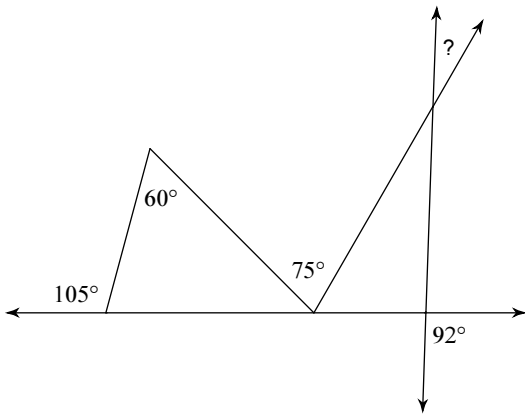

28°

358)

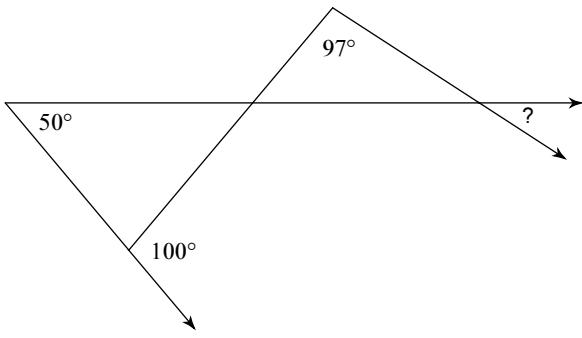

33°

359)

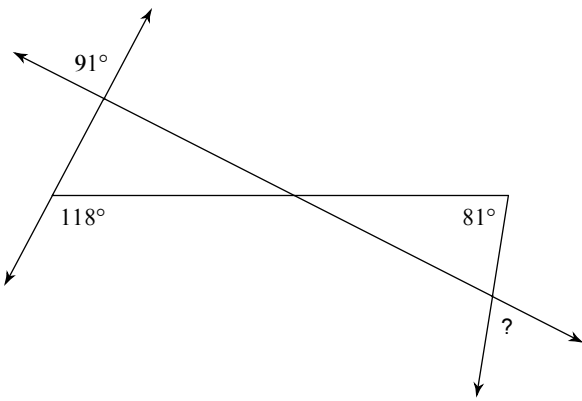

72°

360)

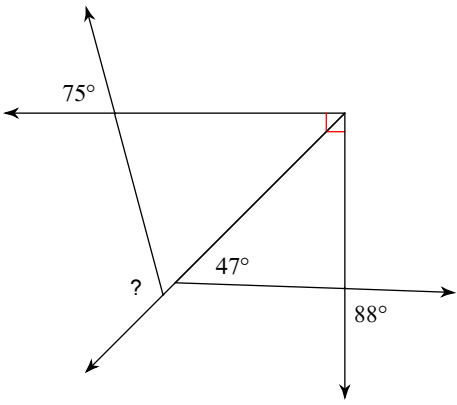

120°

361)

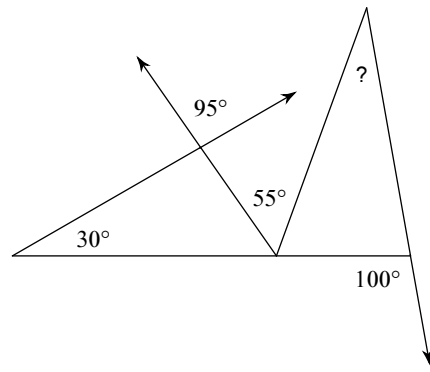

30°

362)

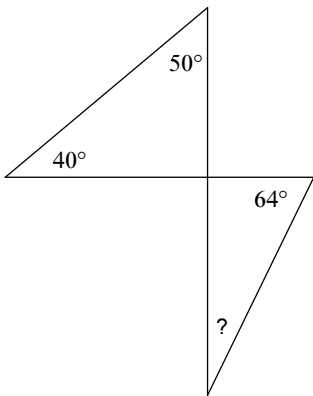

26°

363)

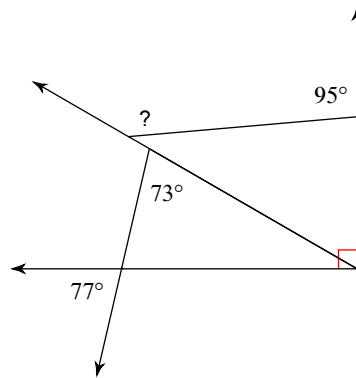

145°

364)

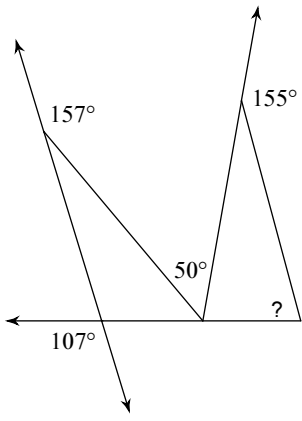

75°

365)

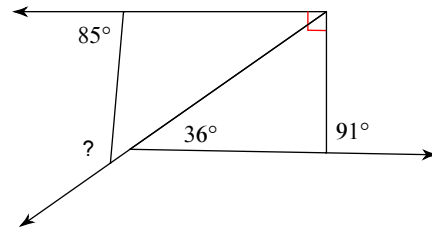

130°

366)

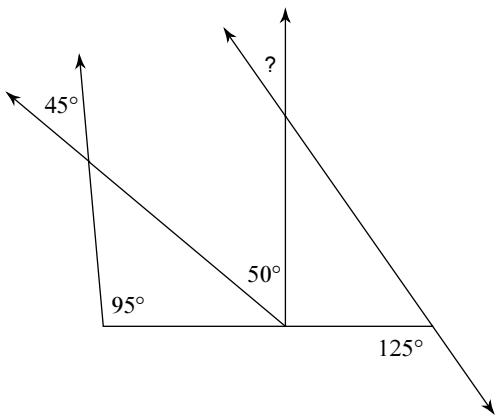

35°

367)

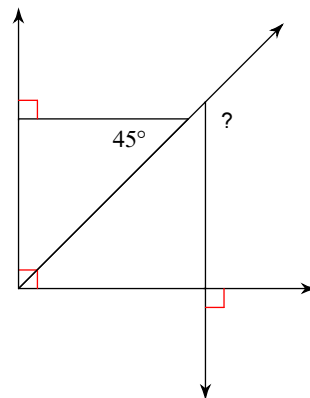

135°

368)

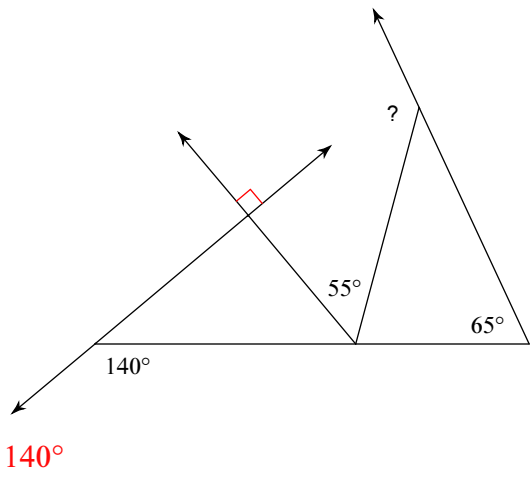

369)

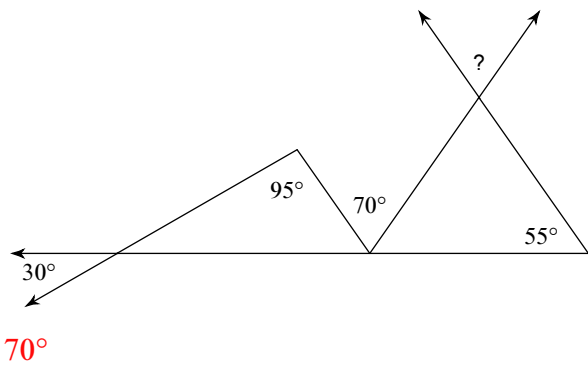

370)

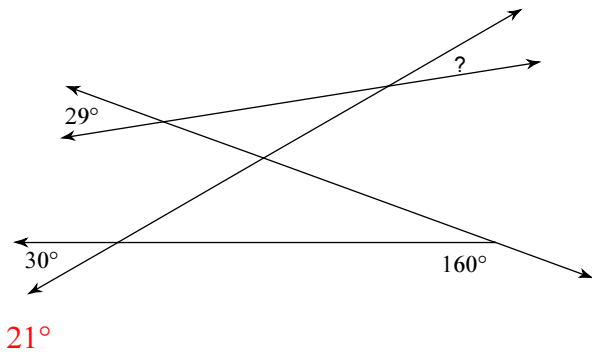

21°

371)

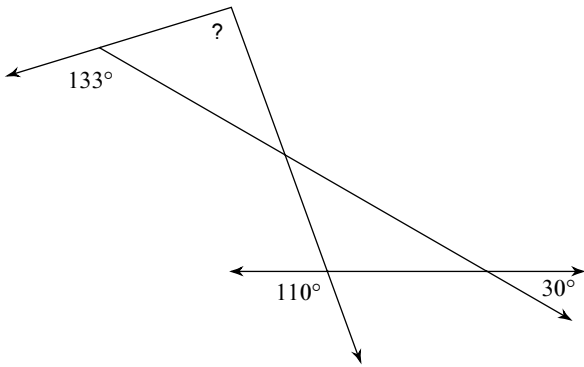

93°

372)

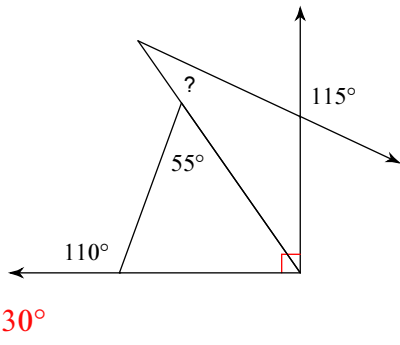

373)

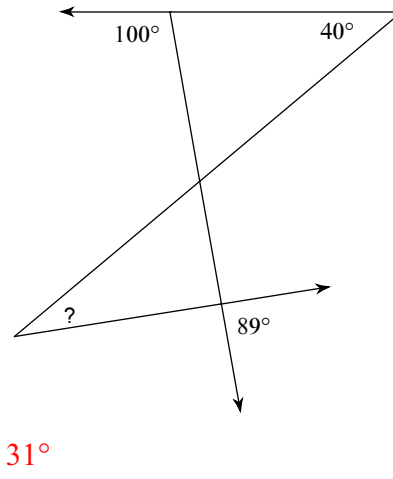

374)

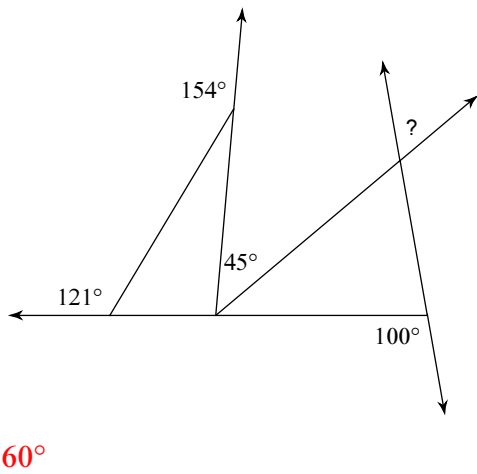

375)

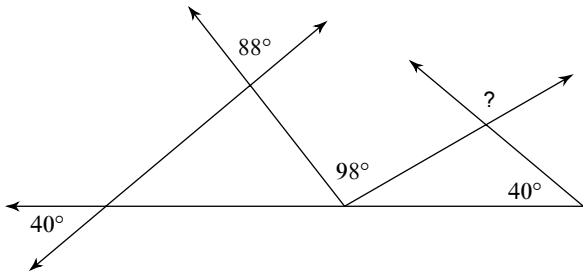

110°

376)

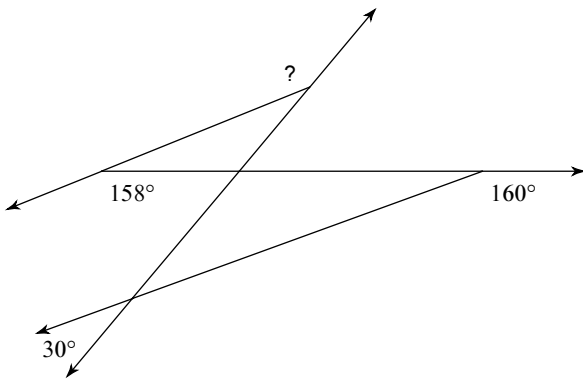

152°

377)

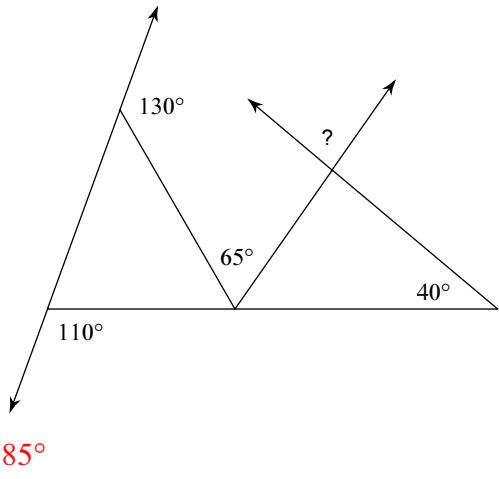

378)

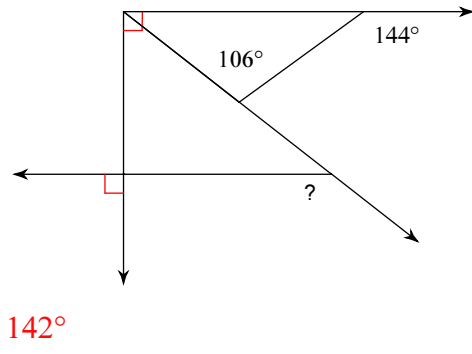

142°

379)

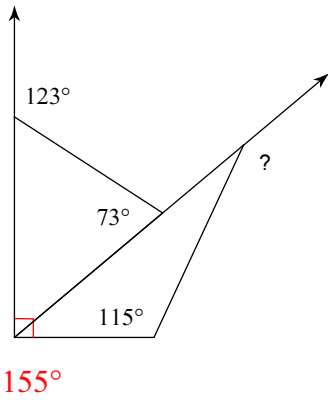

155°

380)

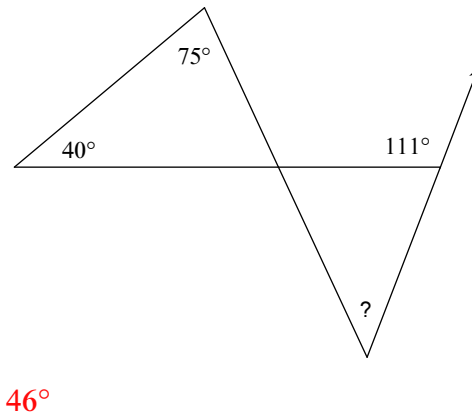

46°

381)

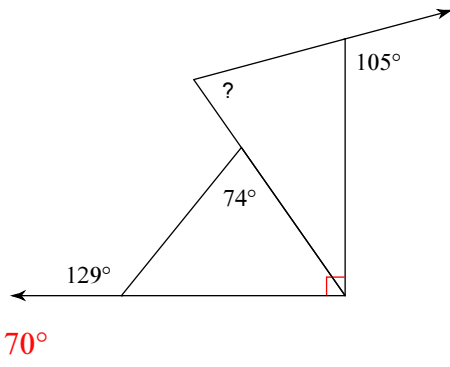

382)

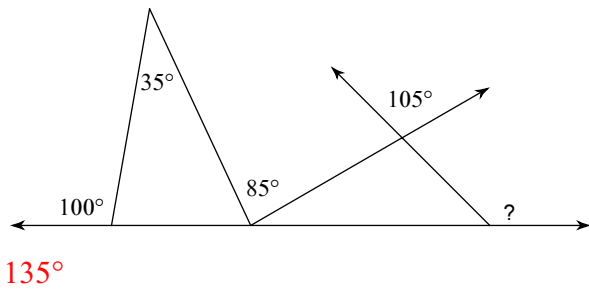

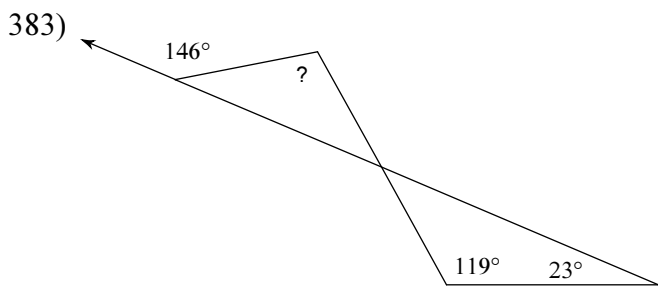

108°

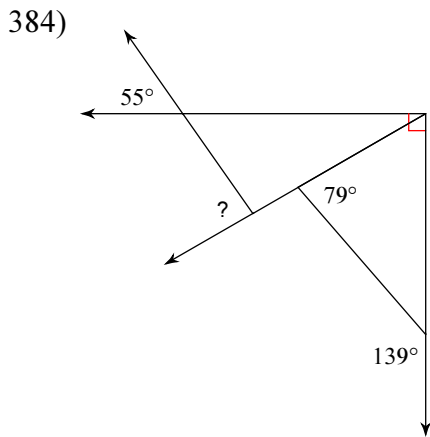

85°

385)

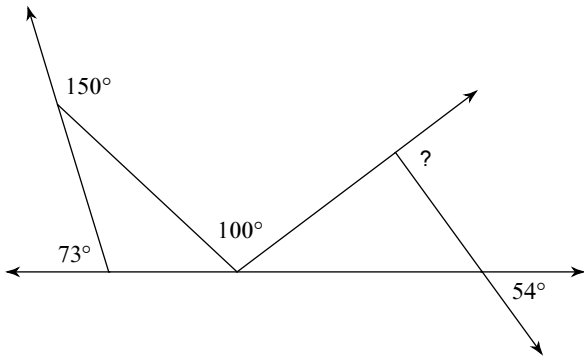

91°

386)

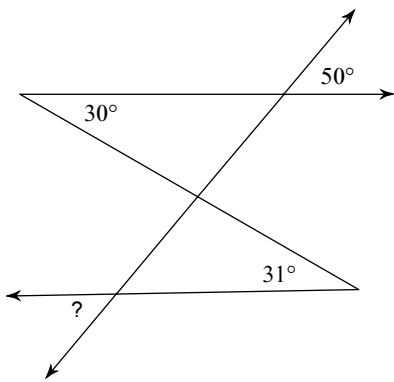

49°

387)

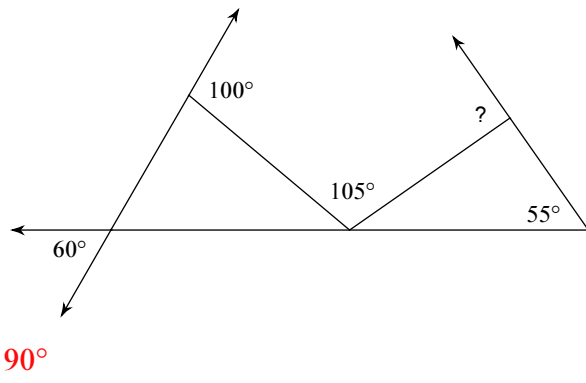

388)

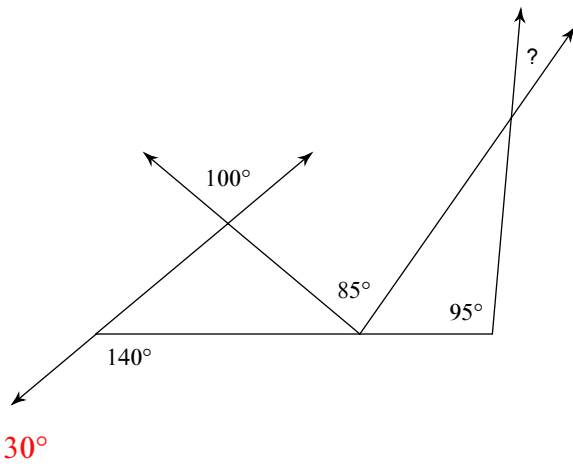

389)

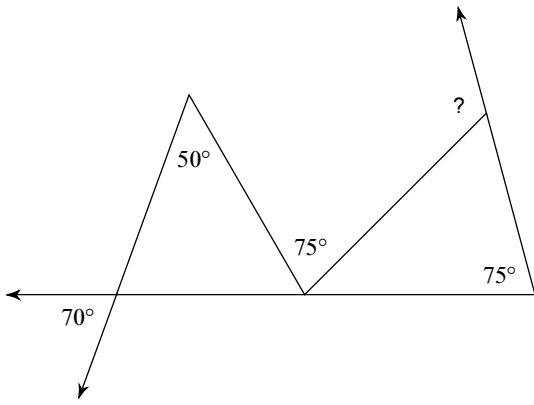

120°

390)

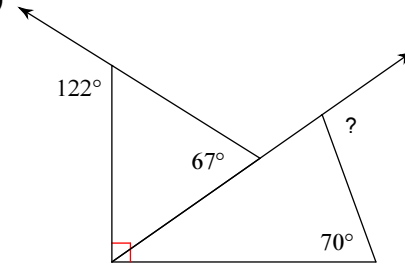

105°

391)

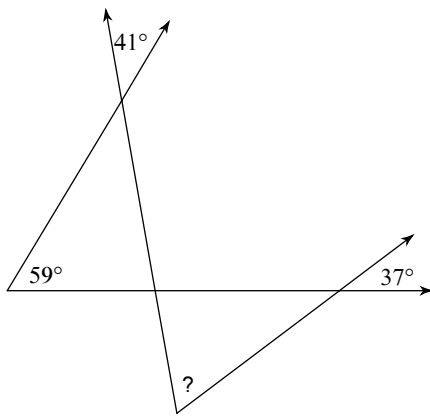

63°

392)

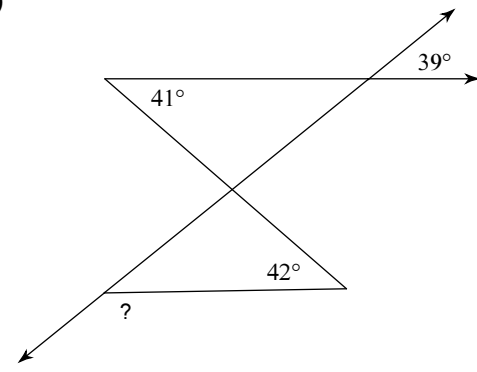

142°

393)

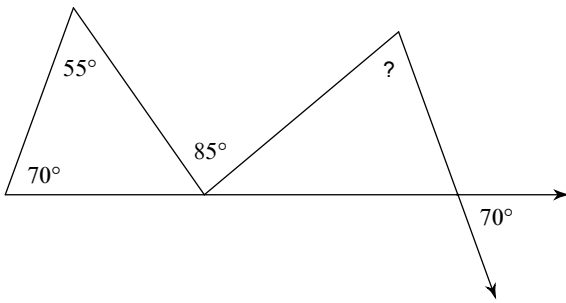

70°

394)

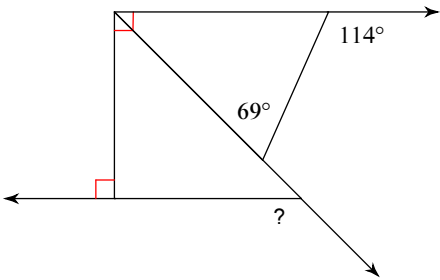

135°

395)

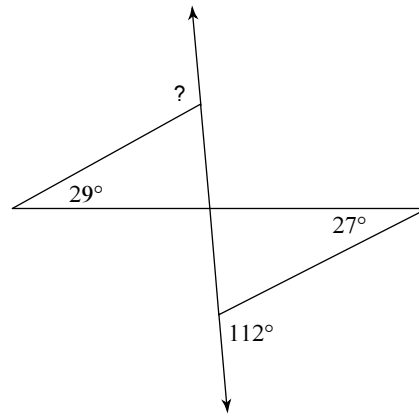

114°

396)

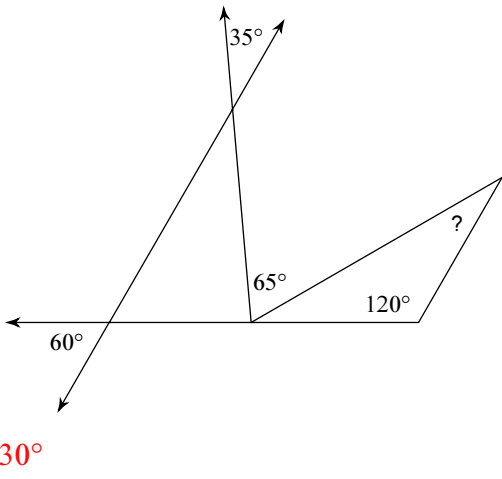

397)

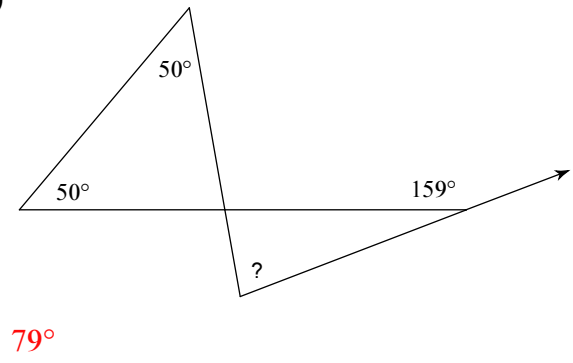

79°

398)

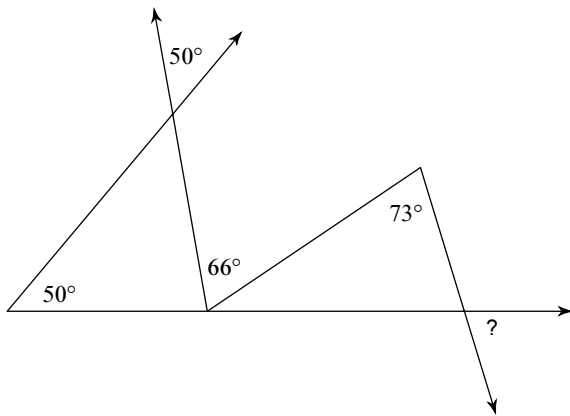

73°

399)

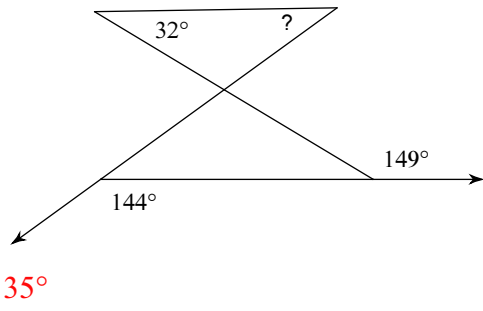

400)

