

The sum of angles in a triangle - Unknown angle

Find the value of third angle

1)

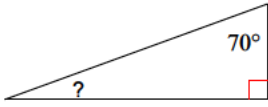

2)

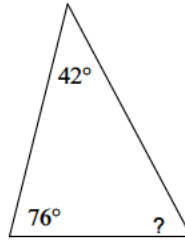

3)

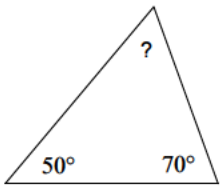

4)

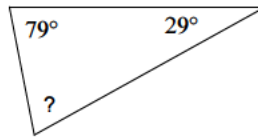

5)

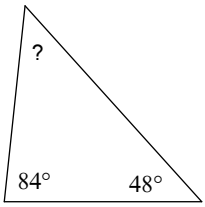

6)

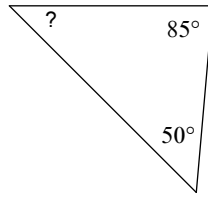

7)

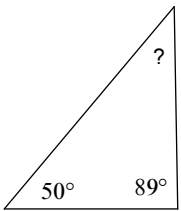

8)

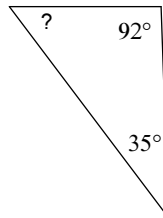

9)

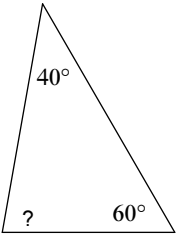

10)

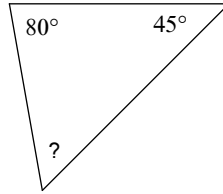

11)

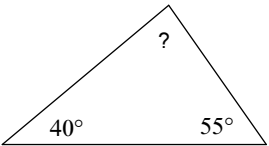

12)

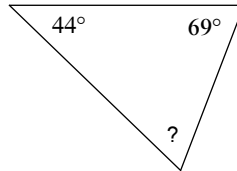

13)

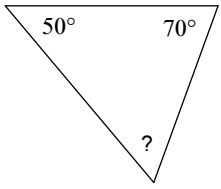

14)

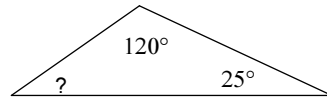

15)

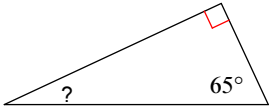

16)

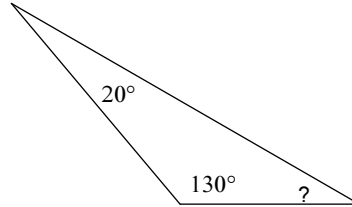

17)

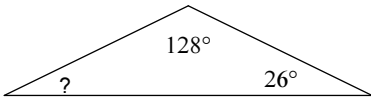

18)

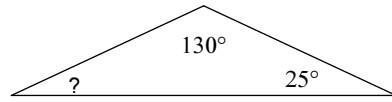

19)

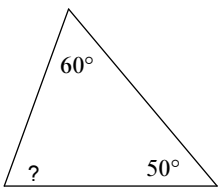

20)

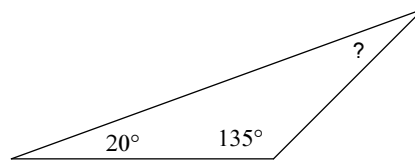

21)

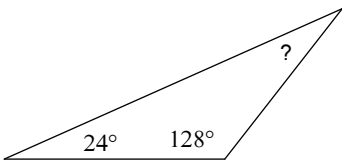

22)

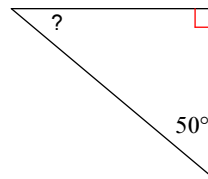

23)

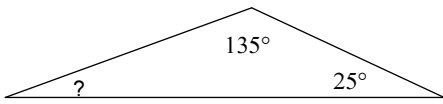

24)

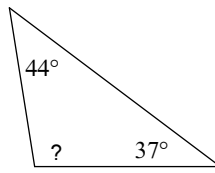

25)

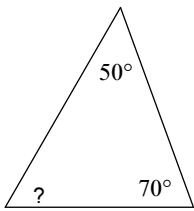

26)

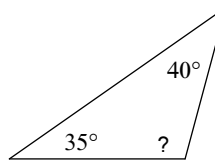

27)

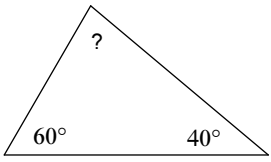

28)

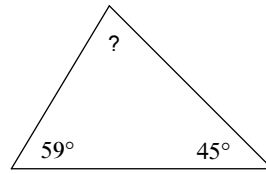

29)

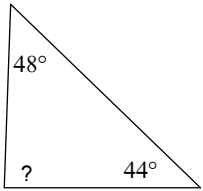

30)

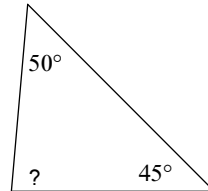

31)

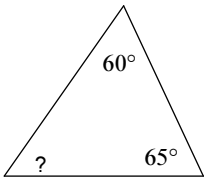

32)

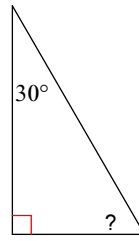

33)

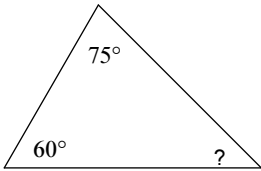

34)

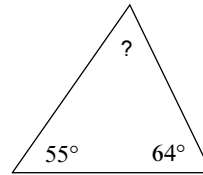

35)

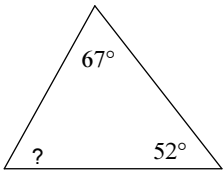

36)

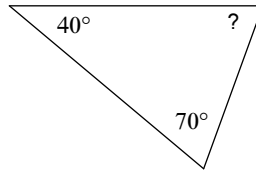

37)

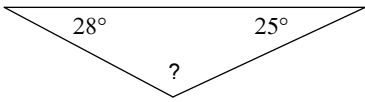

38)

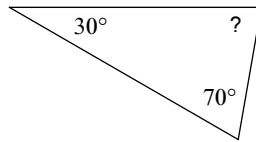

39)

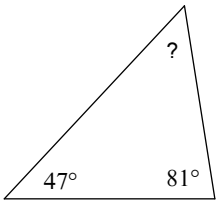

40)

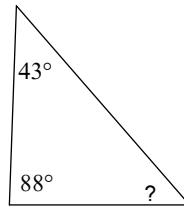

41)

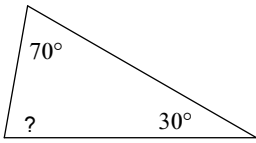

42)

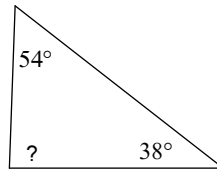

43)

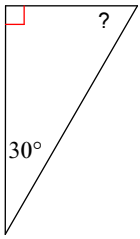

44)

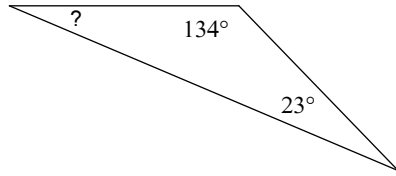

45)

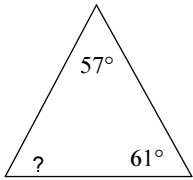

46)

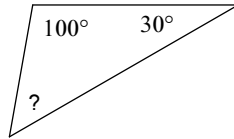

47)

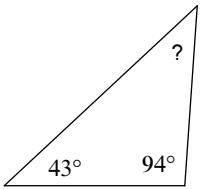

48)

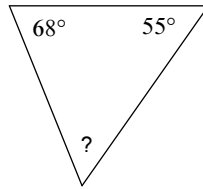

49)

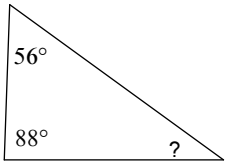

50)

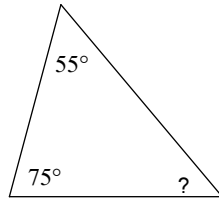

51)

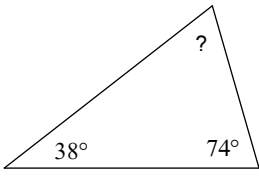

52)

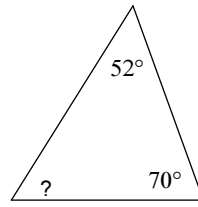

53)

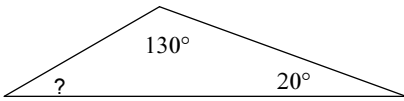

54)

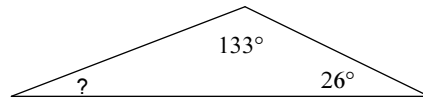

55)

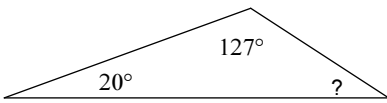

56)

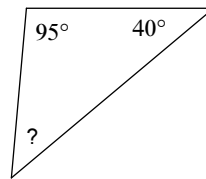

57)

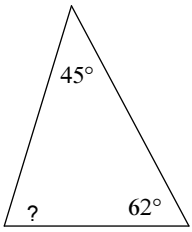

58)

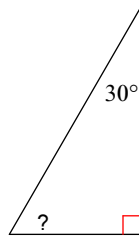

59)

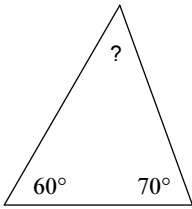

60)

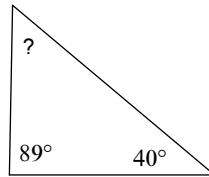

61)

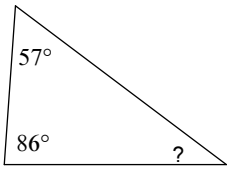

62)

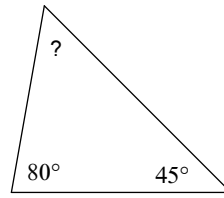

63)

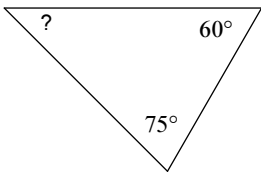

64)

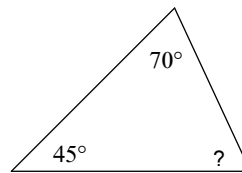

65)

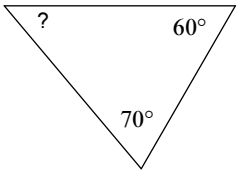

66)

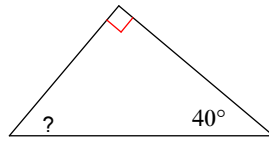

67)

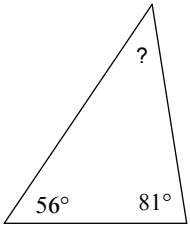

68)

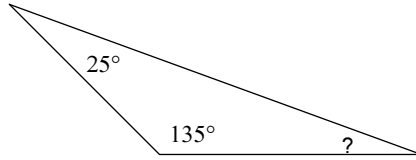

69)

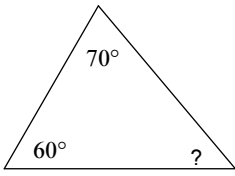

70)

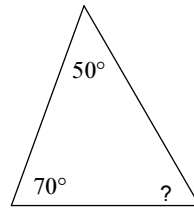

71)

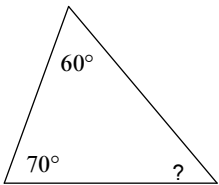

72)

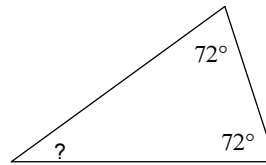

73)

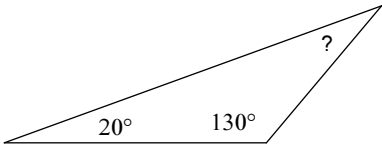

74)

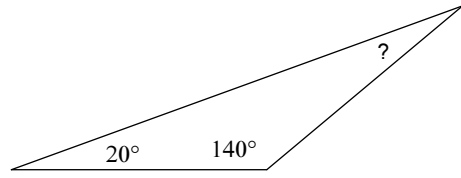

75)

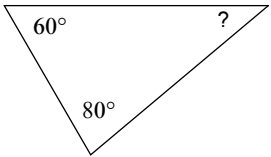

76)

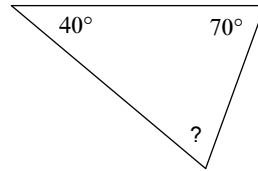

77)

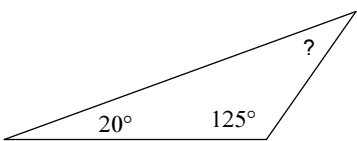

78)

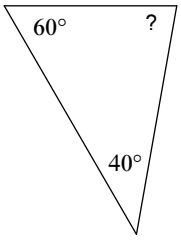

79)

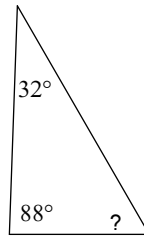

80)

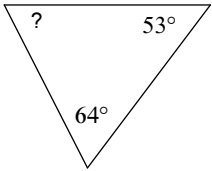

81)

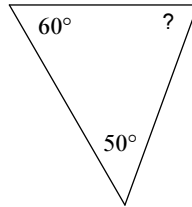

82)

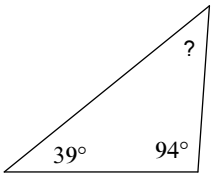

83)

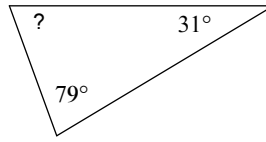

84)

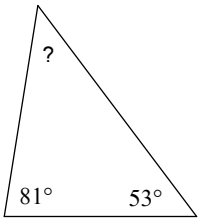

85)

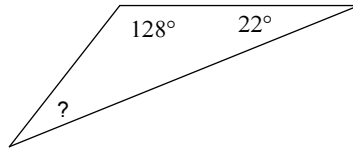

86)

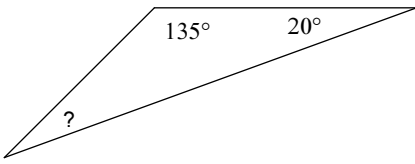

87)

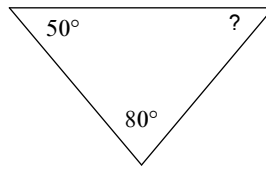

88)

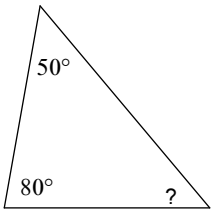

89)

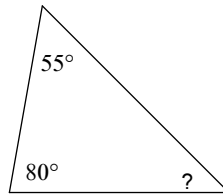

90)

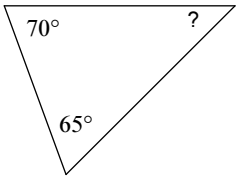

91)

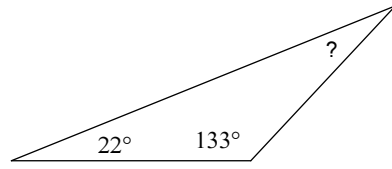

92)

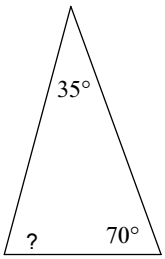

93)

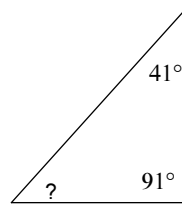

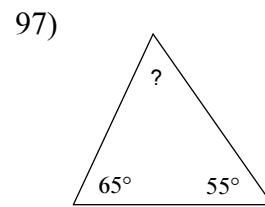
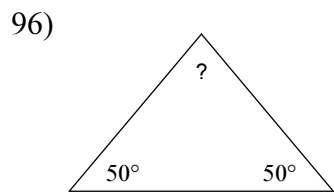
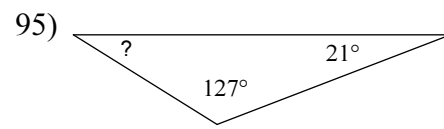
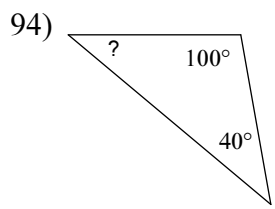

98)

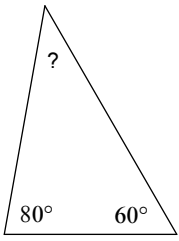

99)

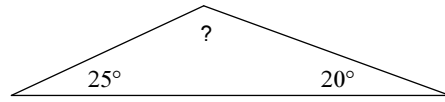

100)

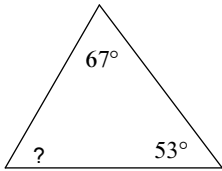

101)

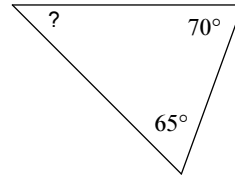

102)

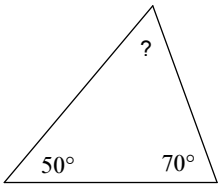

103)

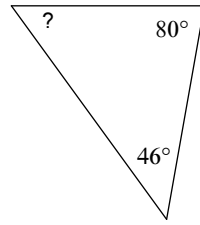

104)

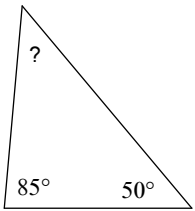

105)

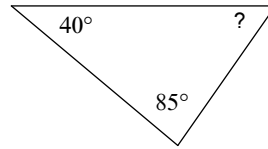

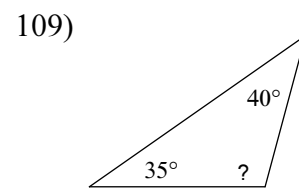
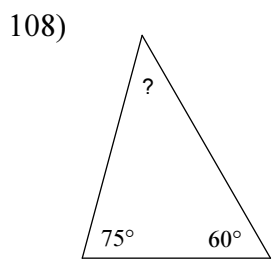
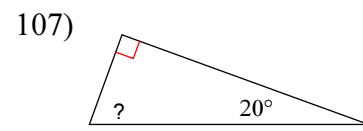
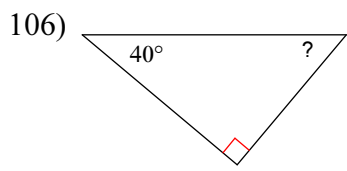

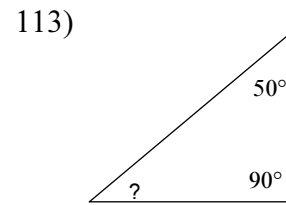
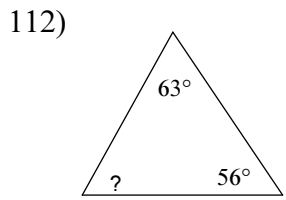
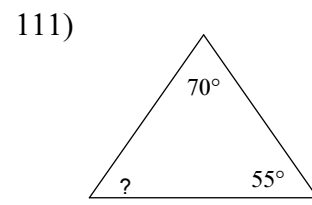
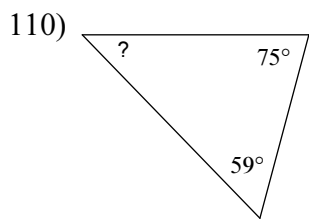

114)

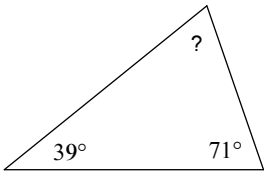

115)

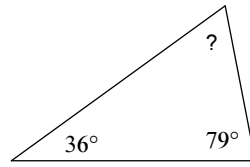

116)

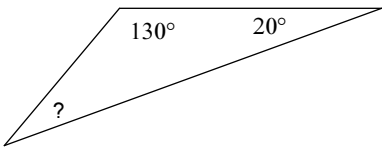

117)

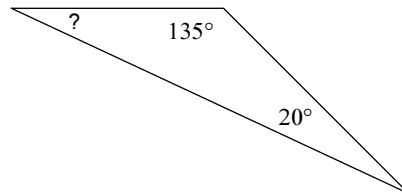

118)

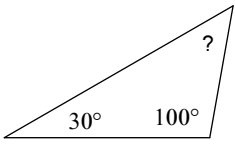

119)

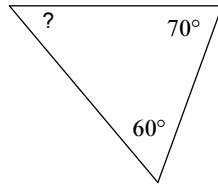

120)

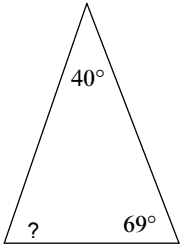

121)

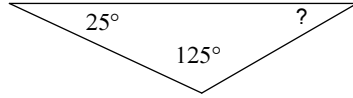

122)

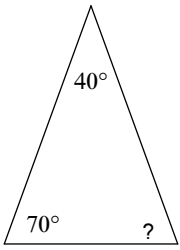

123)

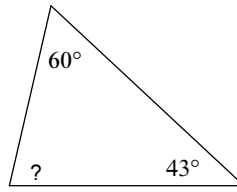

124)

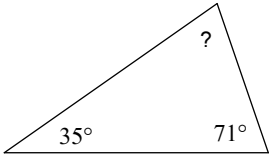

125)

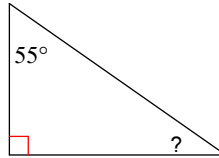

126)

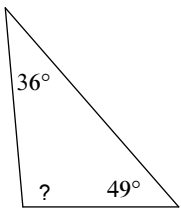

127)

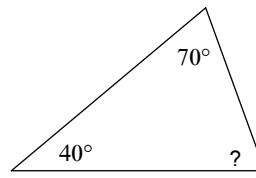

128)

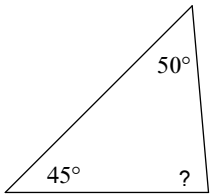

129)

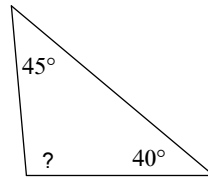

130)

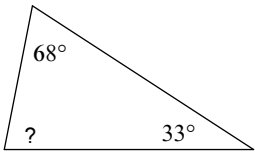

131)

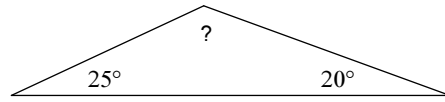

132)

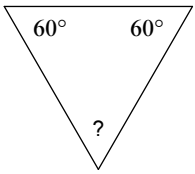

133)

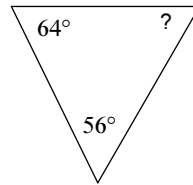

134)

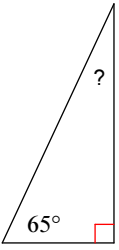

135)

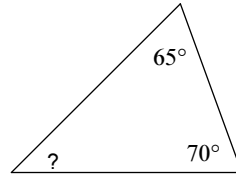

136)

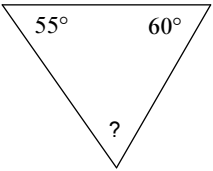

137)

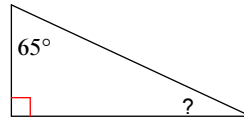

138)

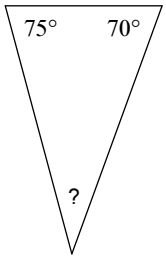

139)

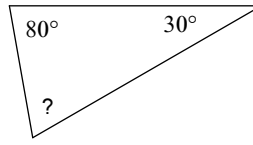

140)

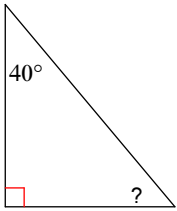

141)

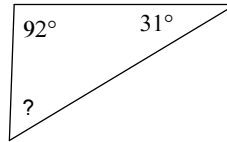

142)

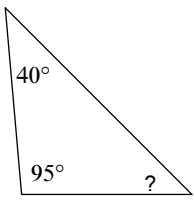

143)

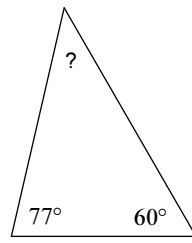

144)

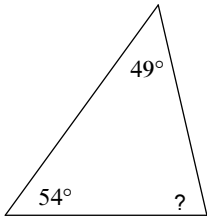

145)

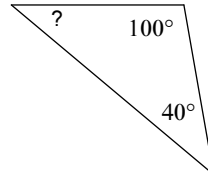

146)

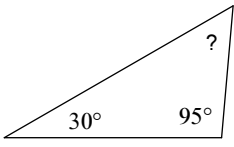

147)

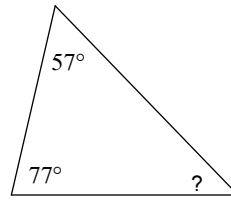

148)

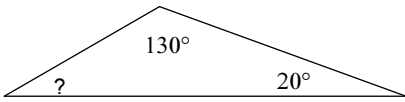

149)

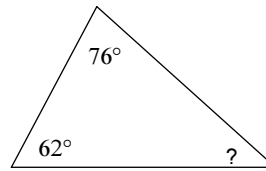

150)

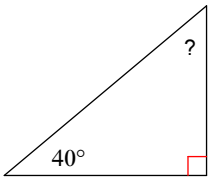

151)

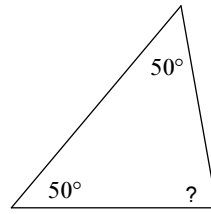

152)

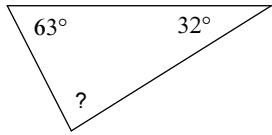

153)

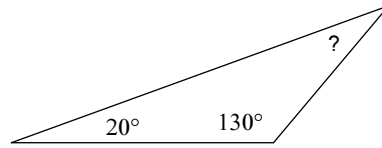

154)

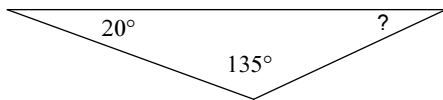

155)

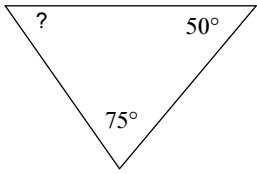

156)

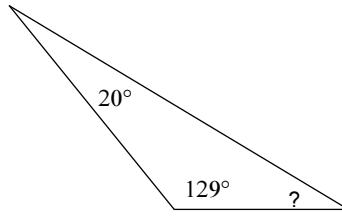

157)

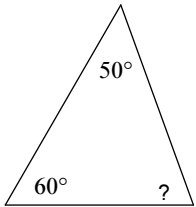

158)

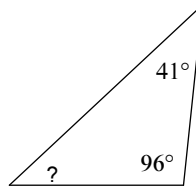

159)

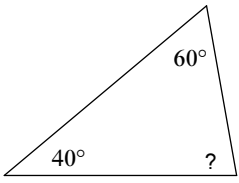

160)

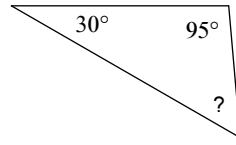

161)

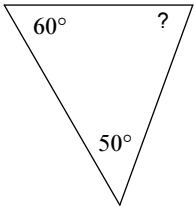

162)

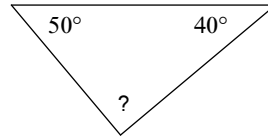

163)

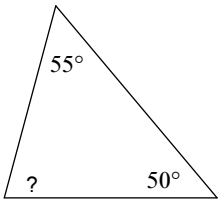

164)

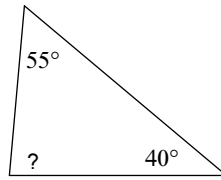

165)

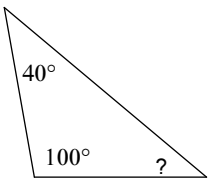

166)

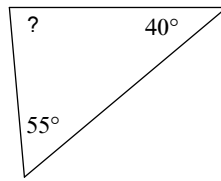

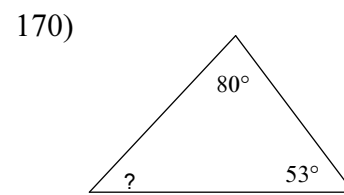
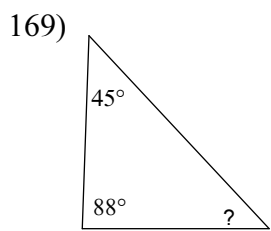
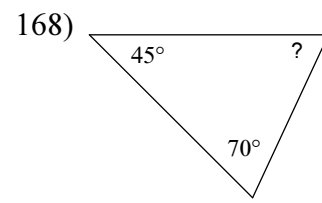
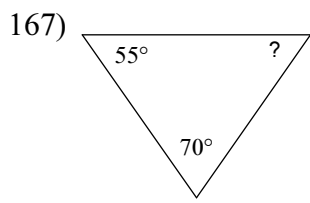

171)

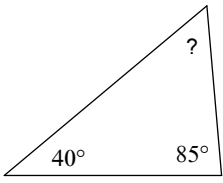

172)

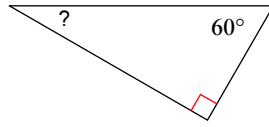

173)

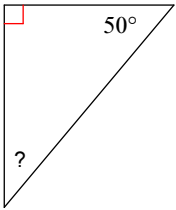

174)

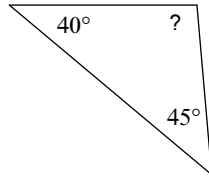

175)

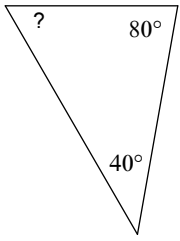

176)

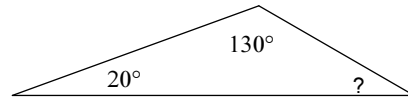

177)

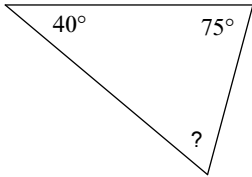

178)

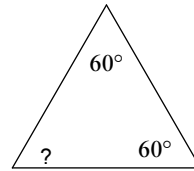

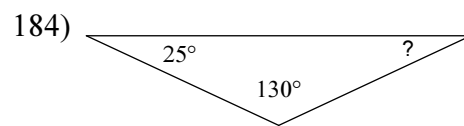
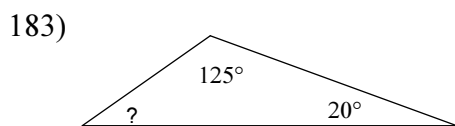
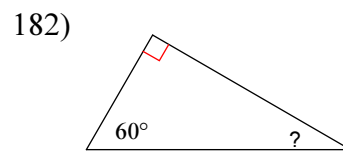
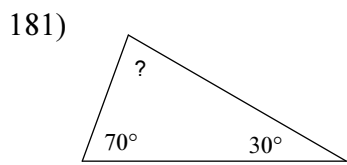
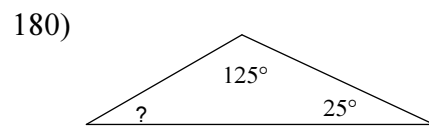
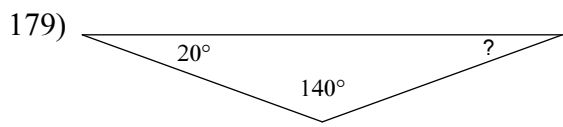

185)

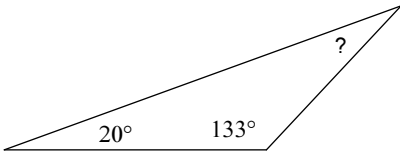

186)

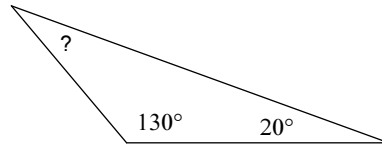

187)

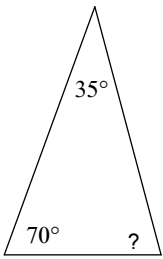

188)

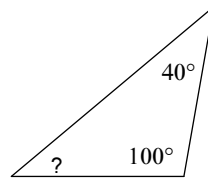

189)

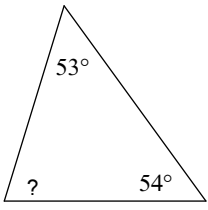

190)

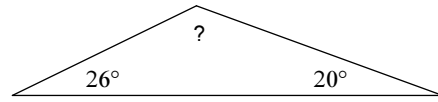

191)

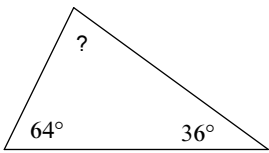

192)

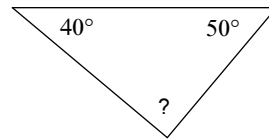

193)

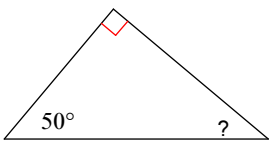

194)

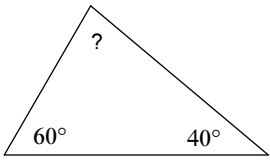

195)

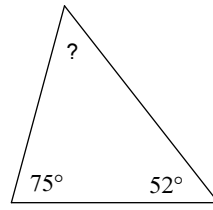

196)

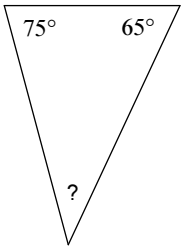

197)

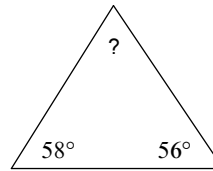

198)

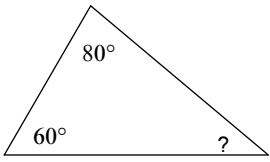

199)

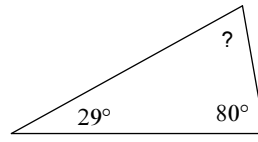

200)

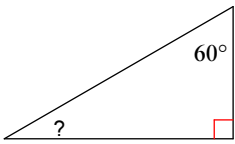

201)

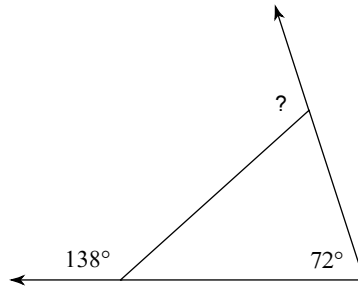

202)

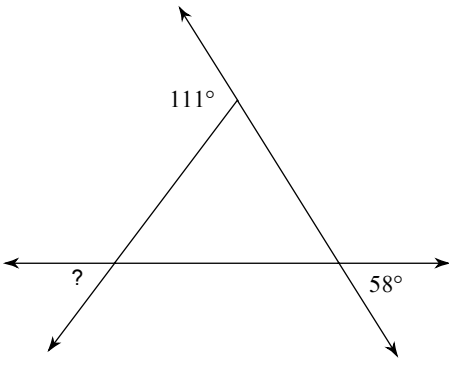

203)

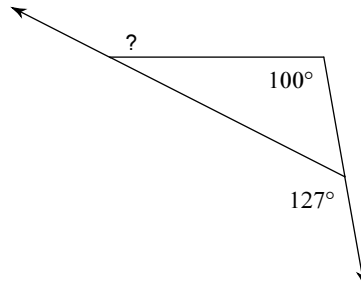

204)

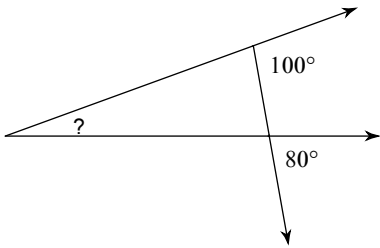

205)

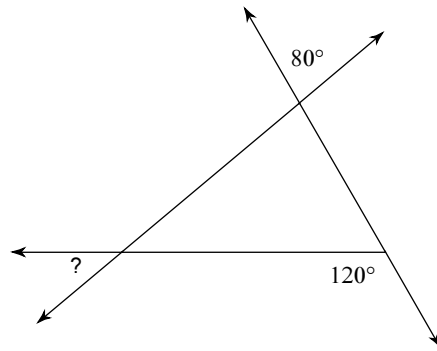

206)

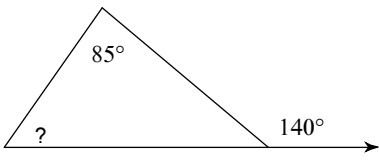

207)

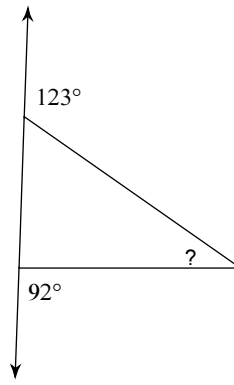

208)

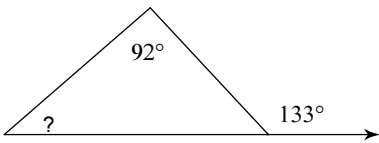

209)

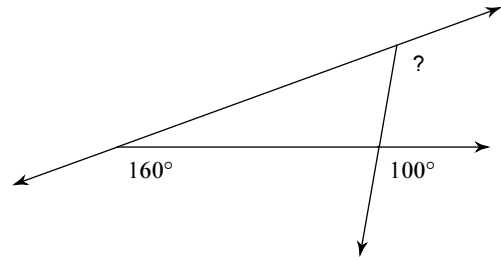

210)

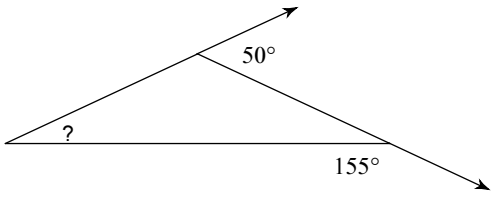

211)

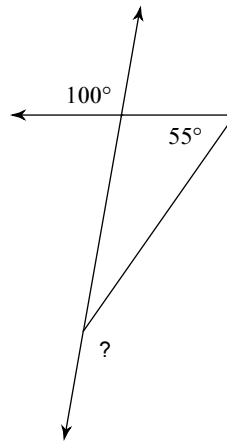

212)

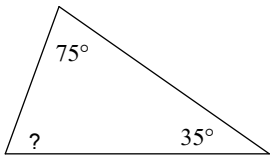

213)

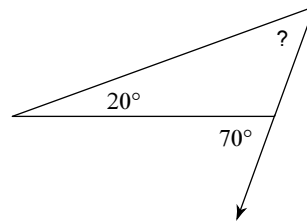

214)

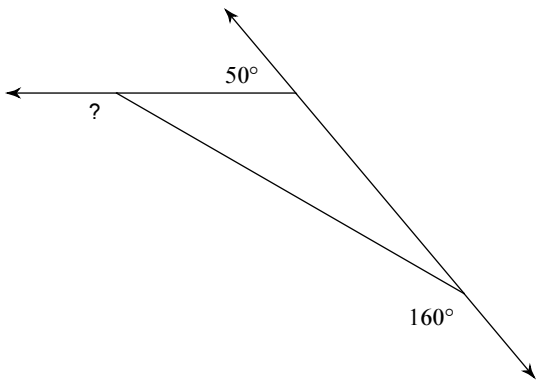

215)

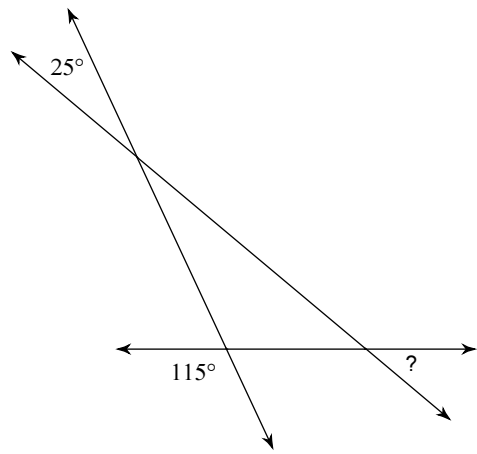

216)

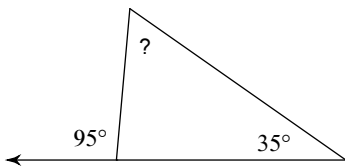

217)

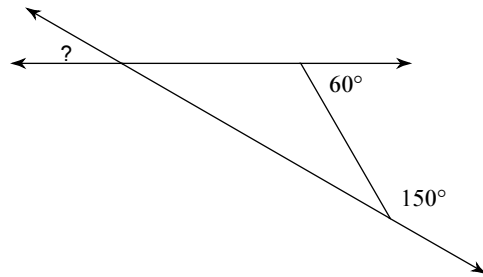

218)

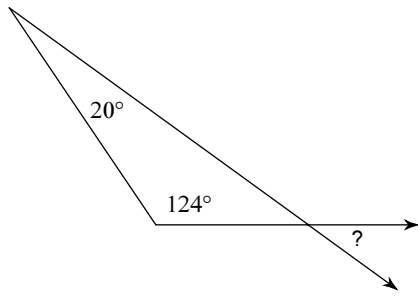

219)

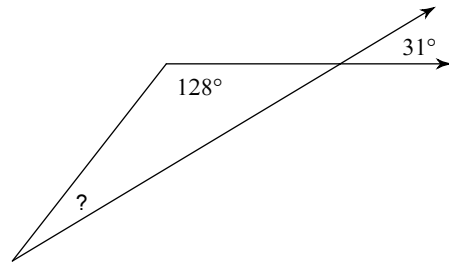

220)

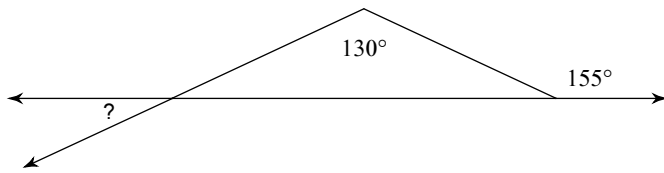

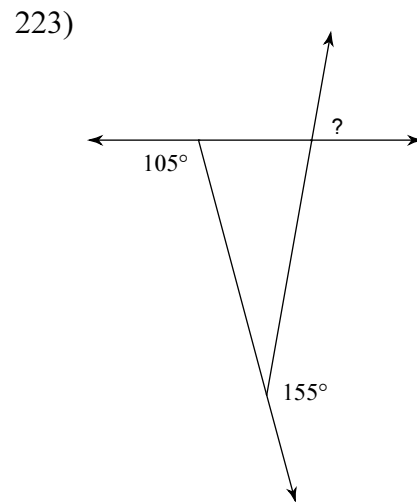
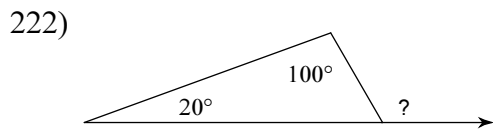
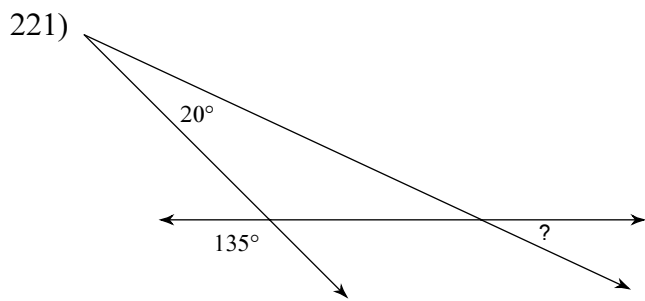

224)

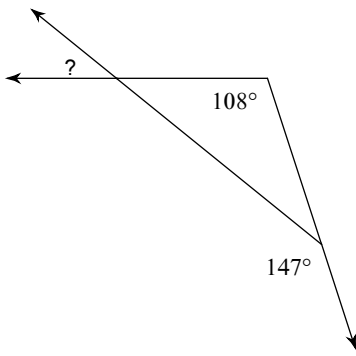

225)

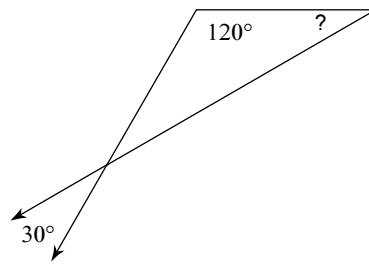

226)

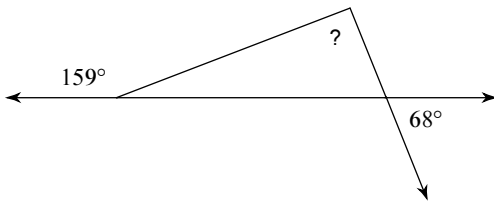

227)

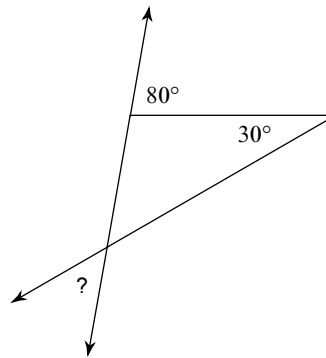

228)

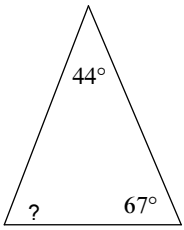

229)

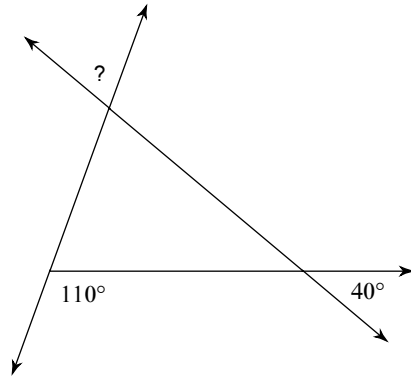

230)

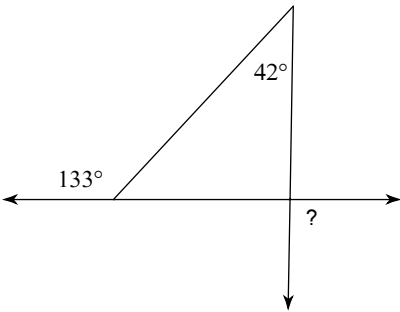

231)

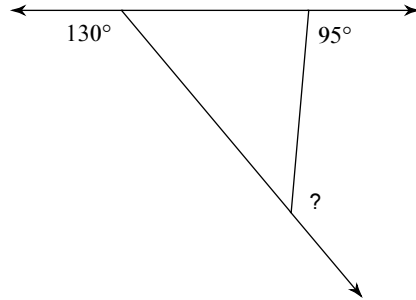

232)

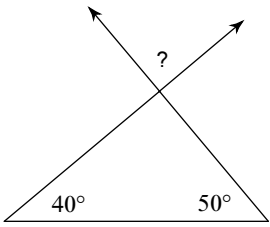

233)

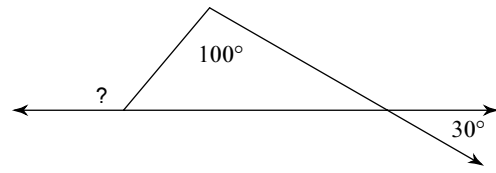

234)

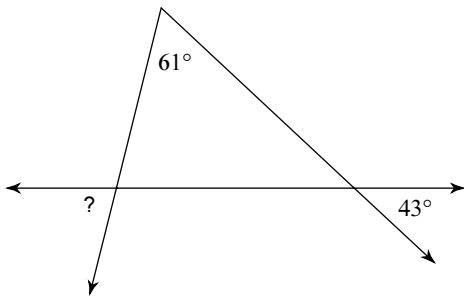

235)

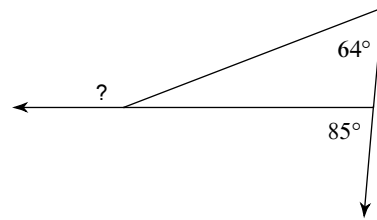

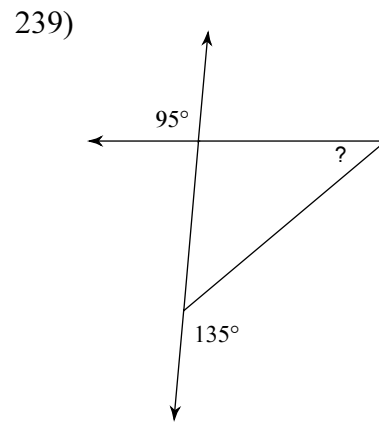
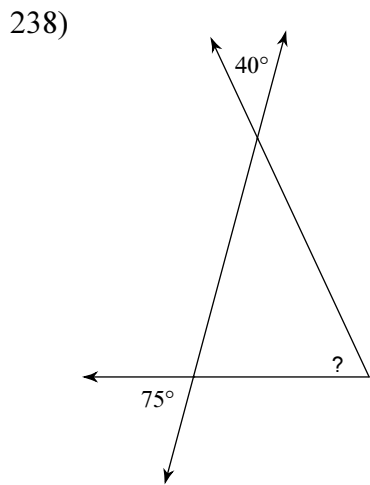
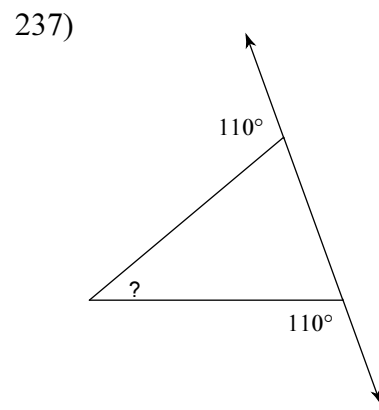
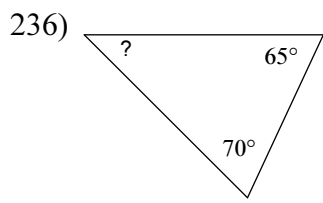

240)

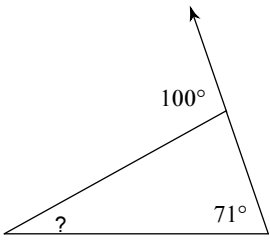

241)

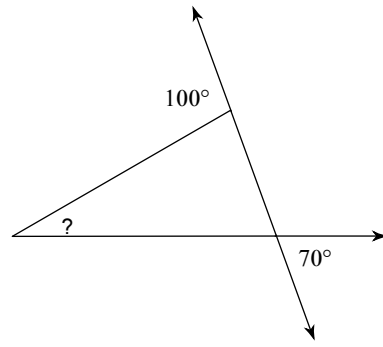

242)

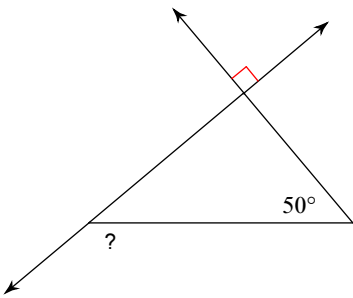

243)

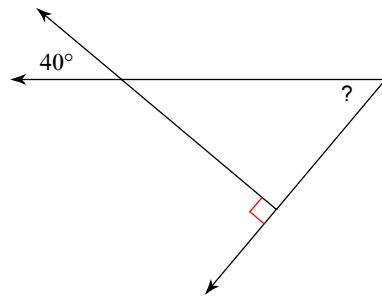

244)

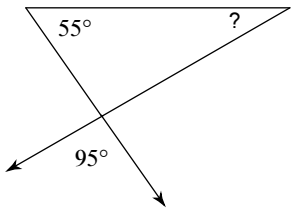

245)

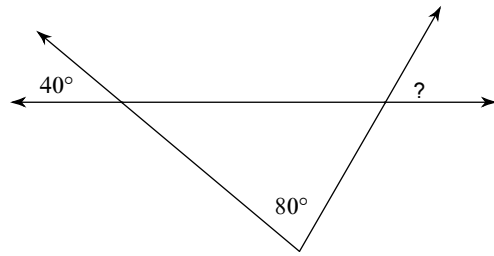

246)

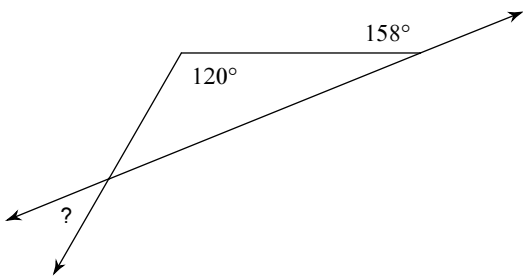

247)

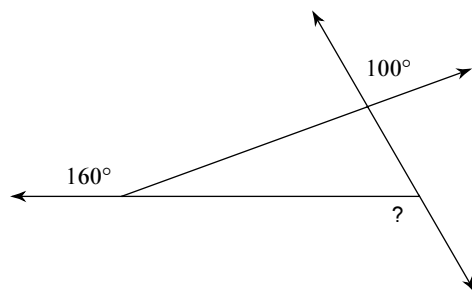

248)

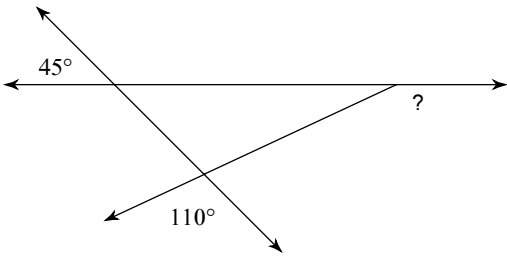

249)

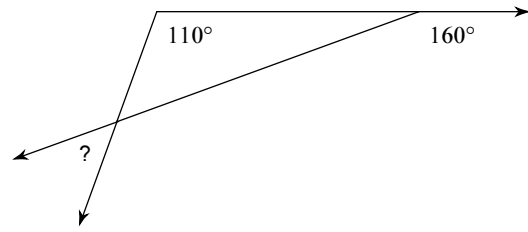

250)

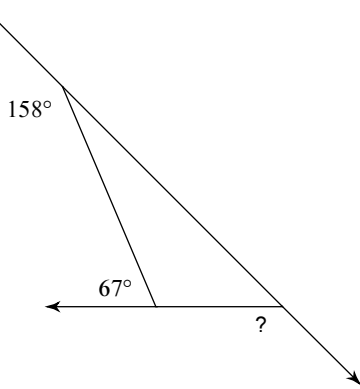

251)

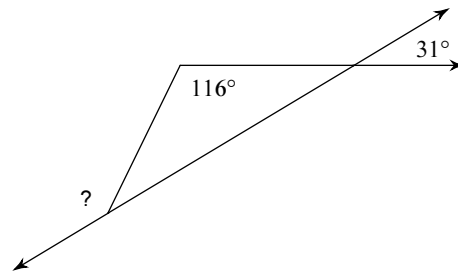

252)

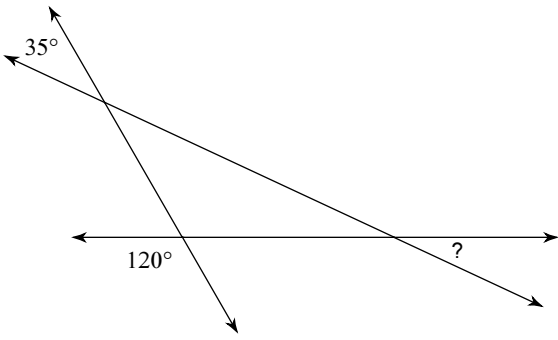

253)

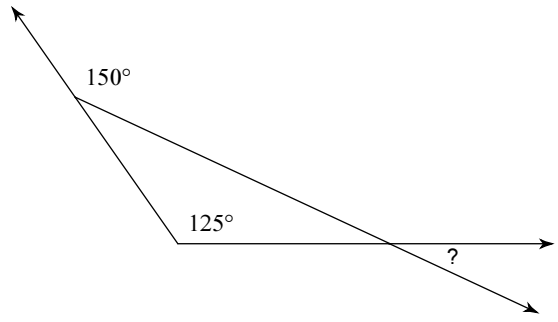

254)

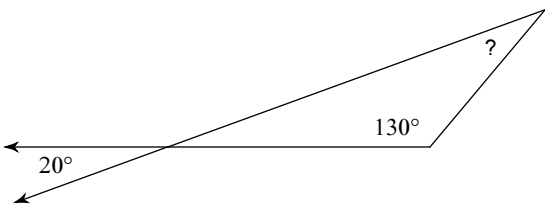

255)

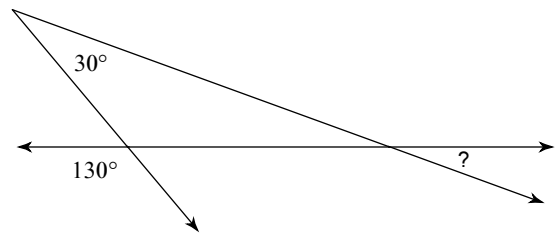

256)

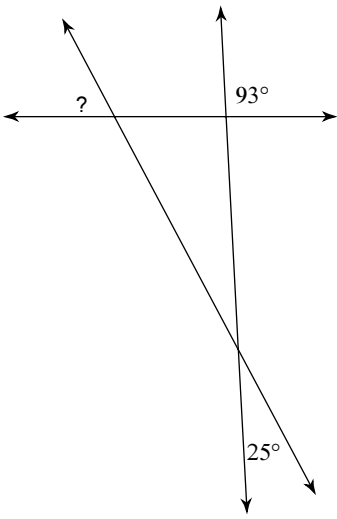

257)

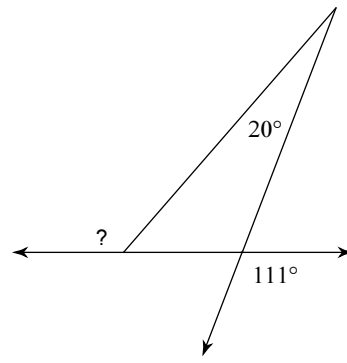

258)

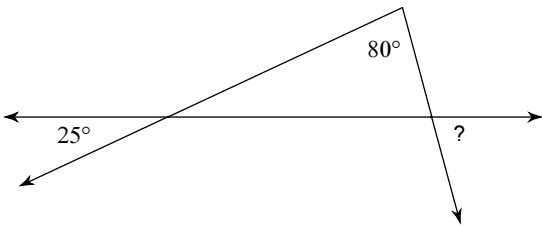

259)

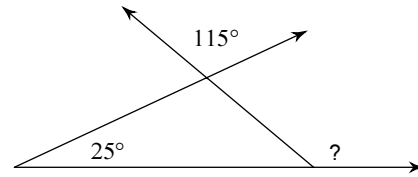

260)

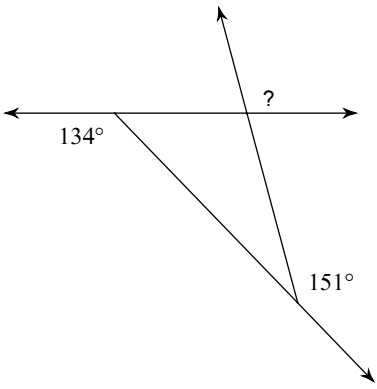

261)

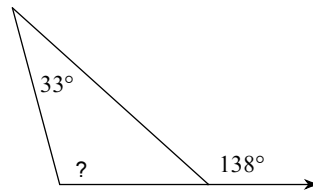

262)

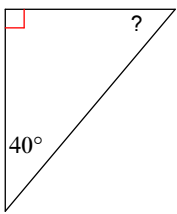

263)

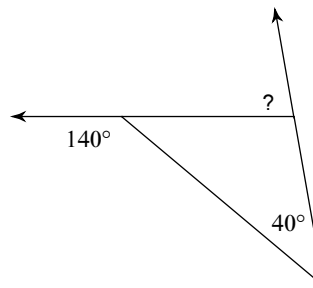

264)

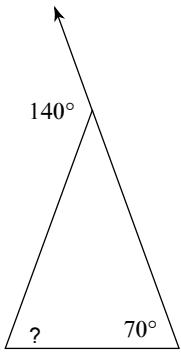

265)

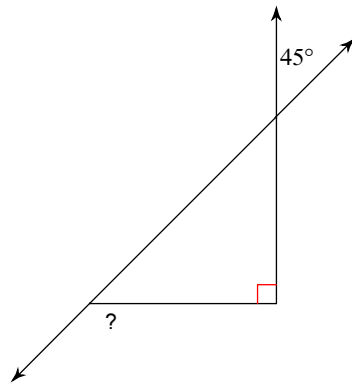

266)

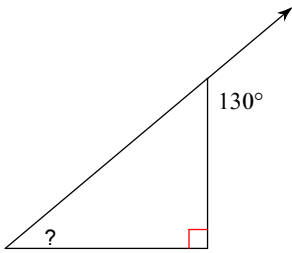

267)

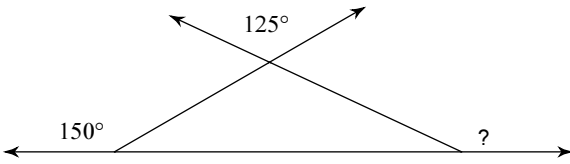

268)

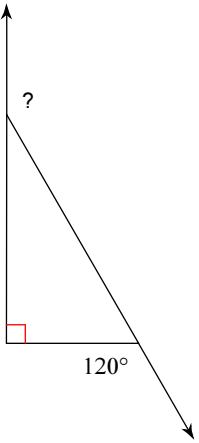

269)

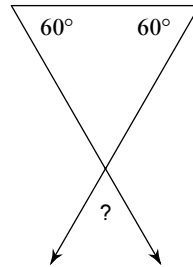

270)

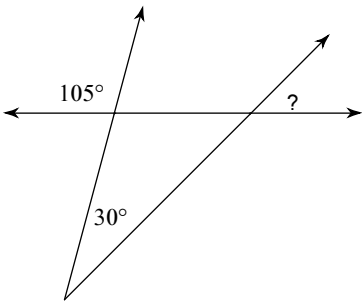

271)

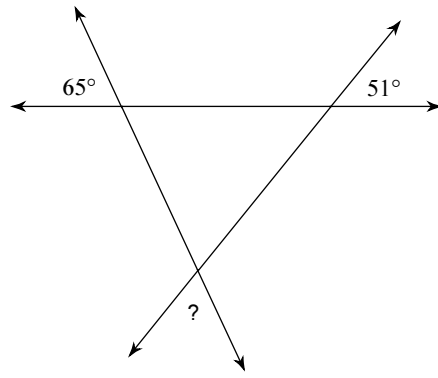

272)

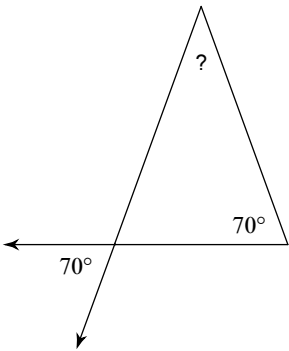

273)

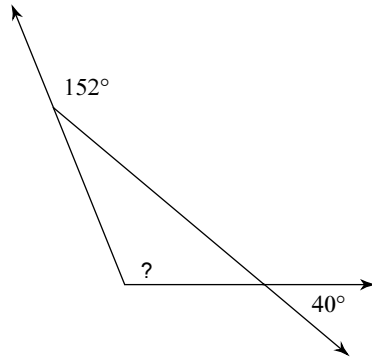

274)

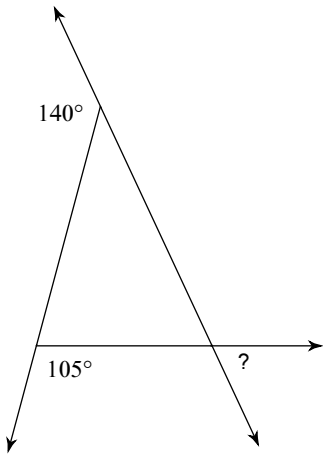

275)

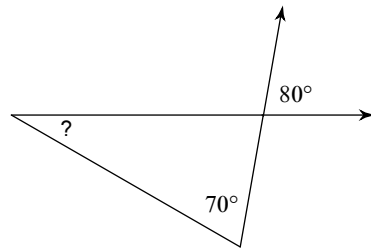

276)

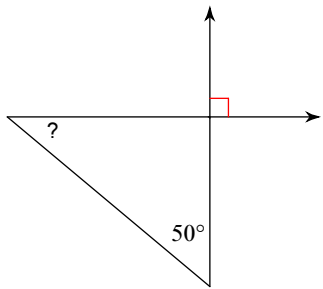

277)

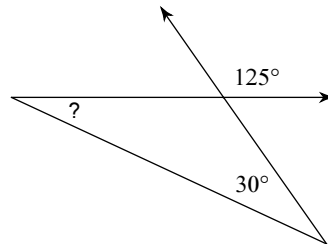

278)

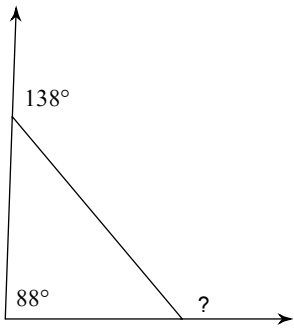

279)

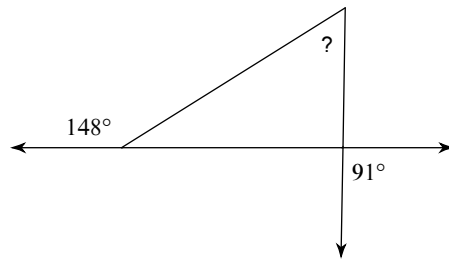

280)

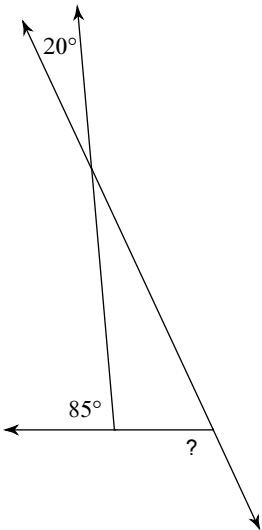

281)

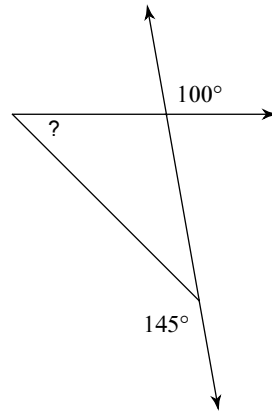

282)

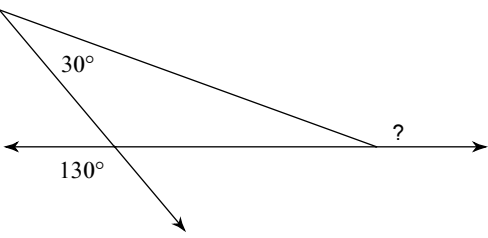

283)

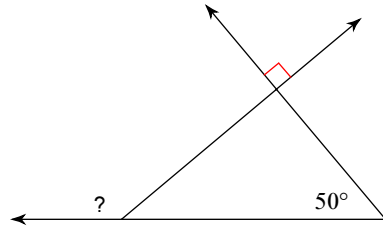

284)

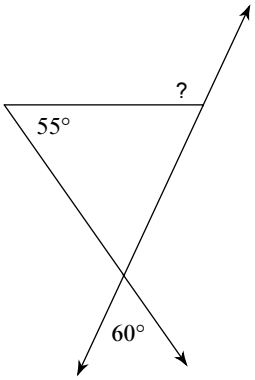

285)

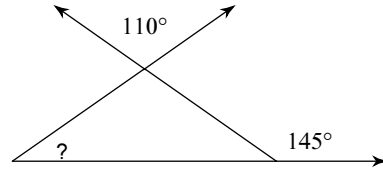

286)

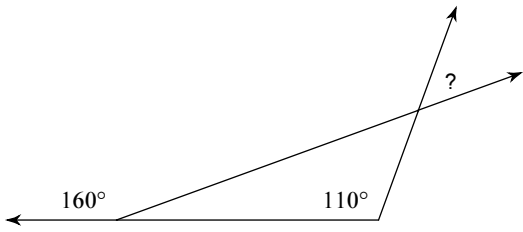

287)

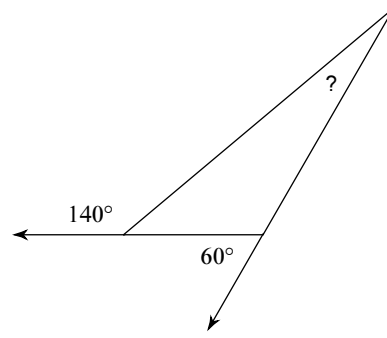

288)

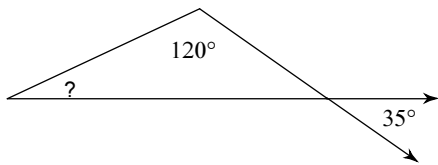

289)

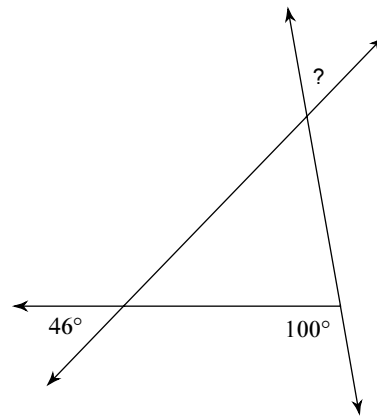

290)

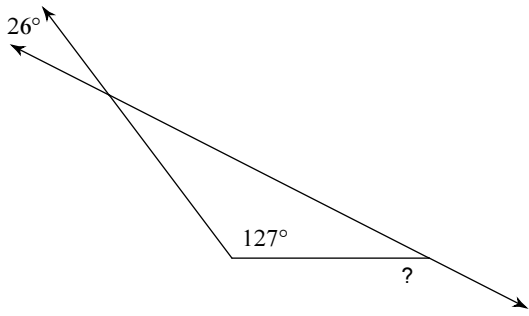

291)

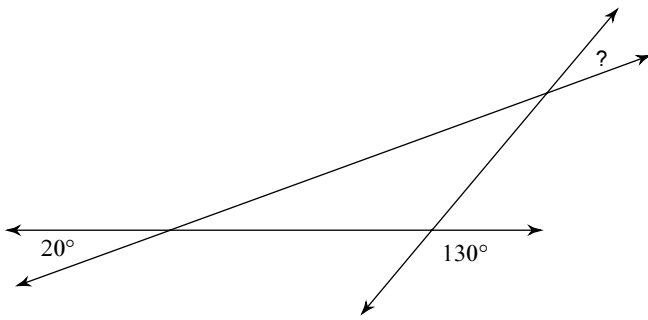

292)

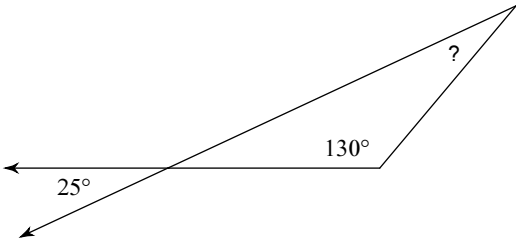

293)

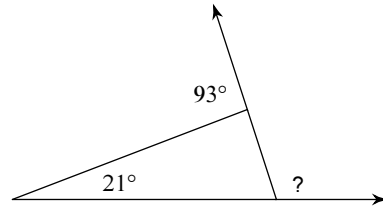

294)

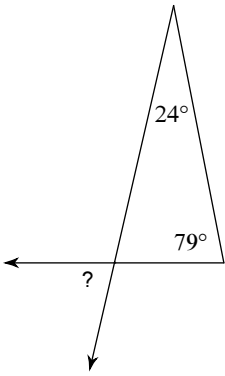

295)

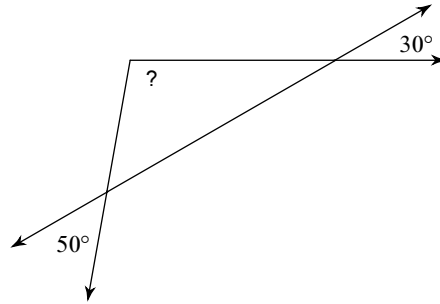

296)

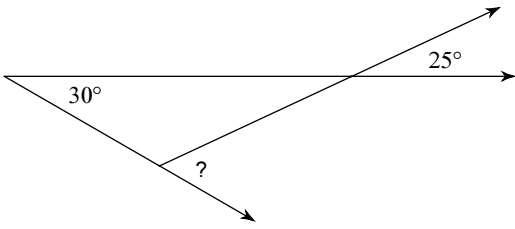

297)

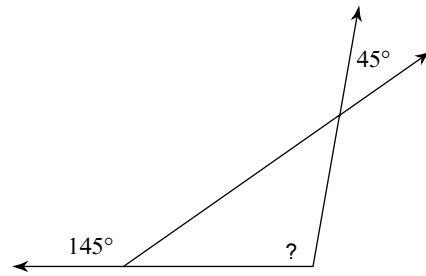

298)

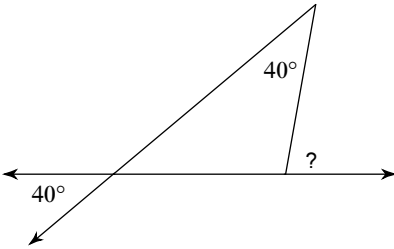

299)

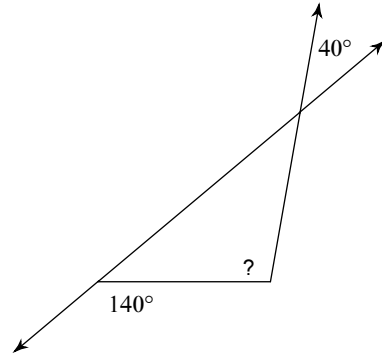

300)

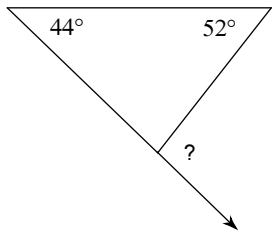

301)

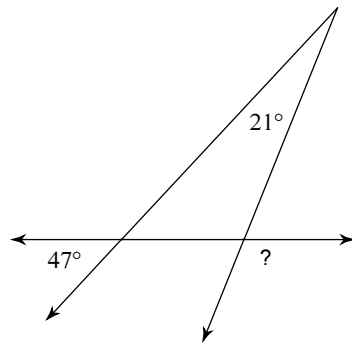

302)

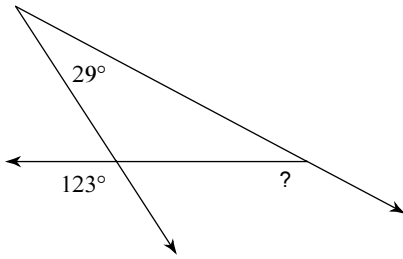

303)

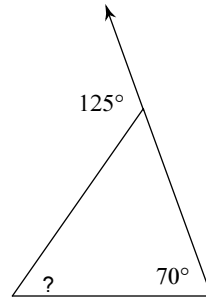

304)

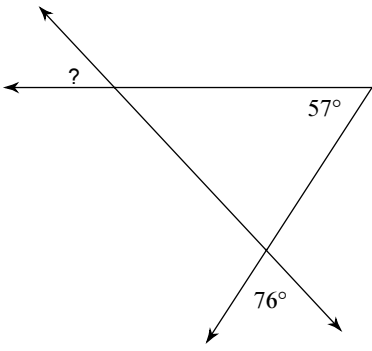

305)

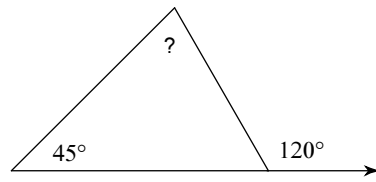

306)

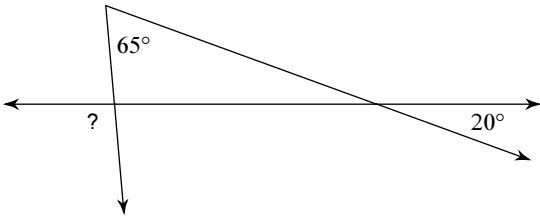

307)

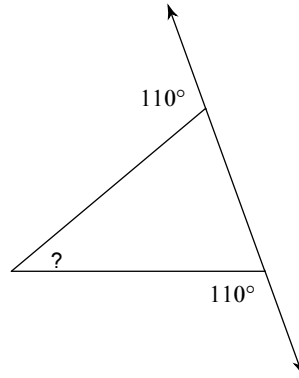

308)

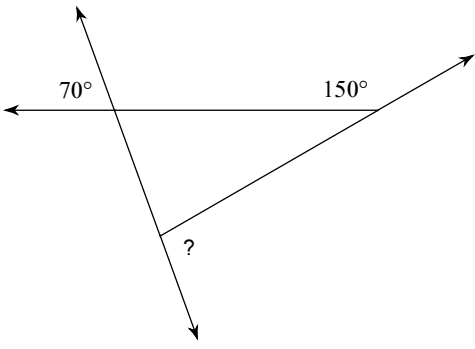

309)

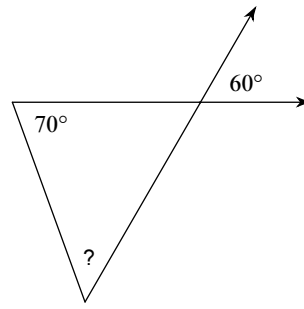

310)

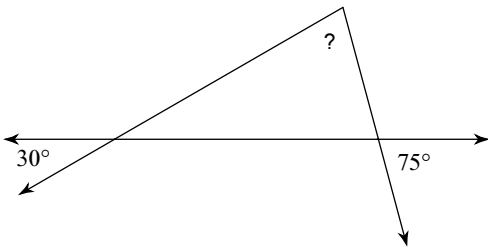

311)

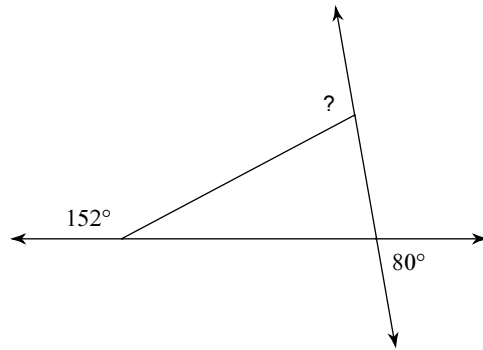

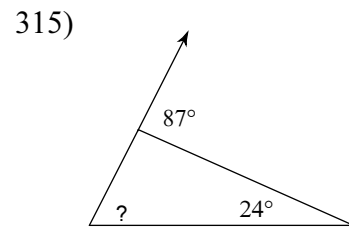
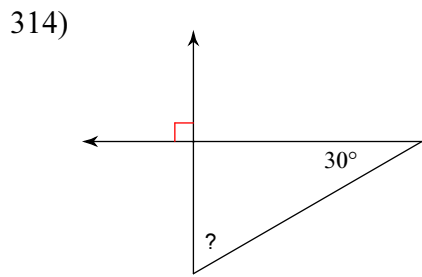
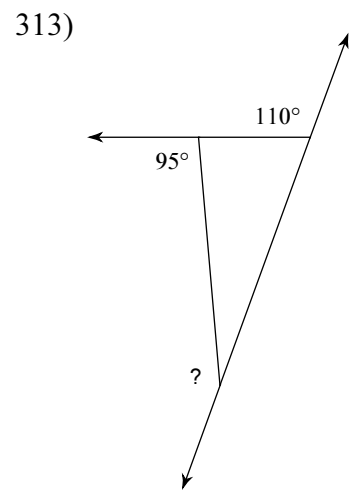
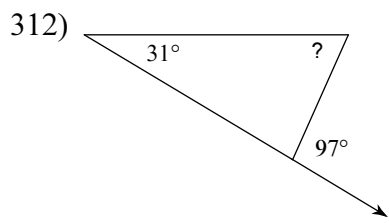

316)

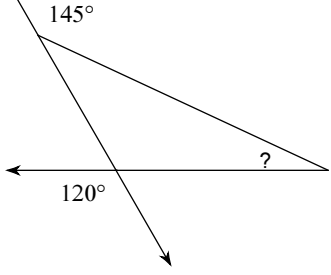

317)

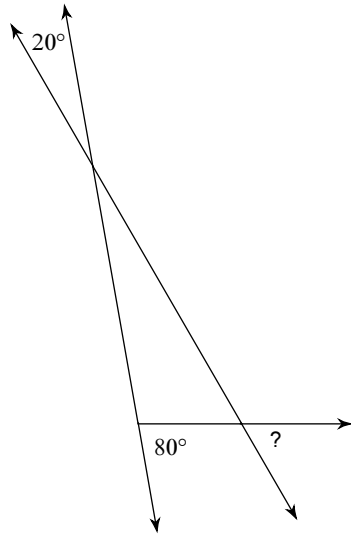

318)

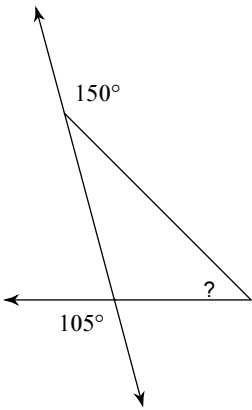

319)

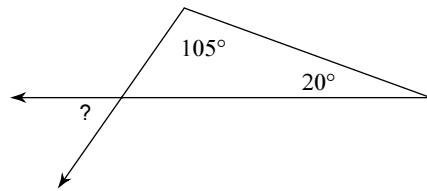

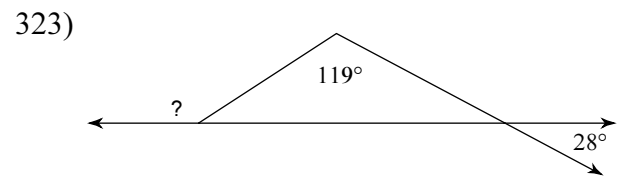
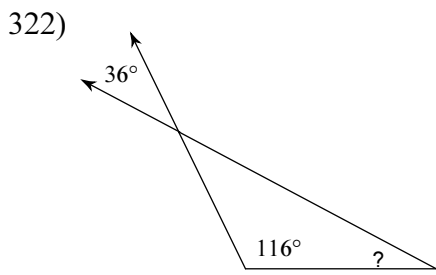
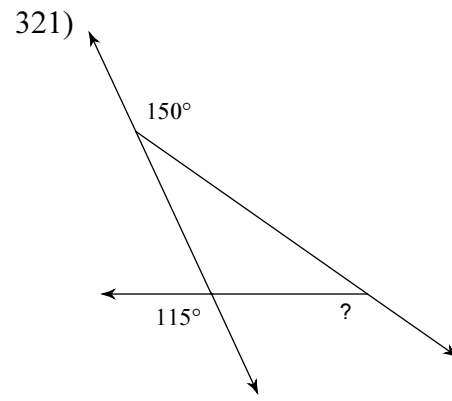
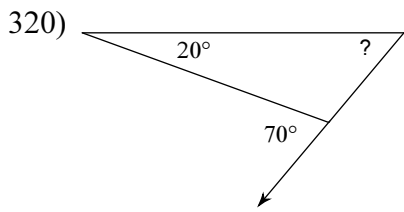

324)

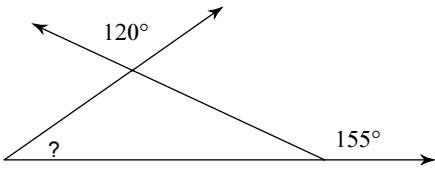

325)

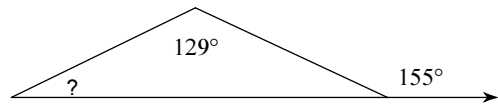

326)

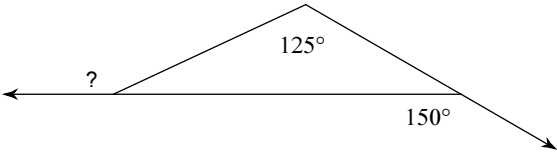

327)

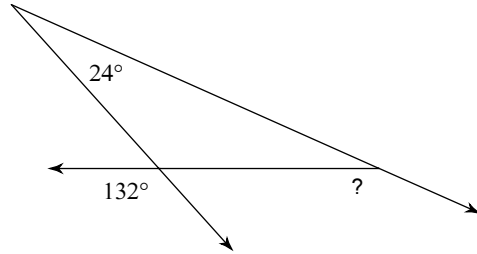

328)

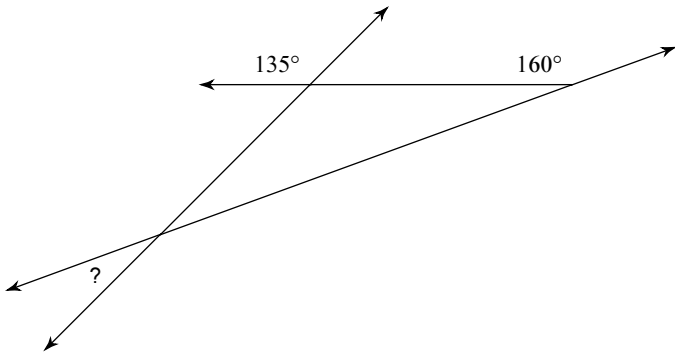

329)

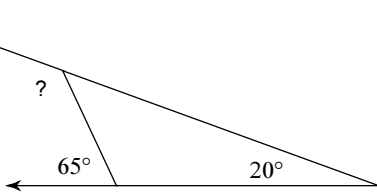

330)

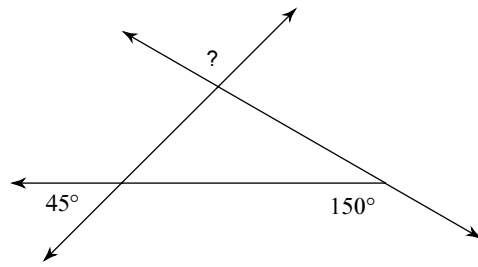

331)

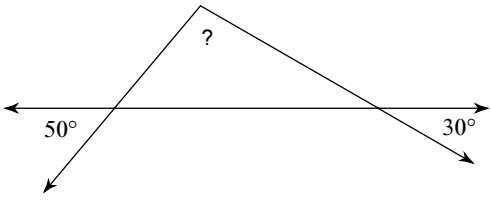

332)

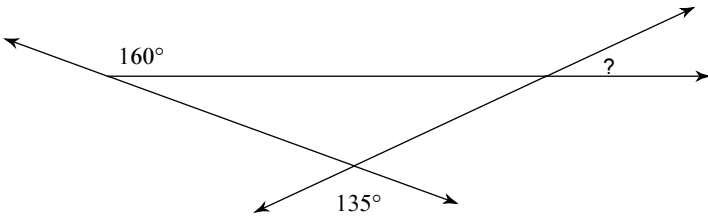

333)

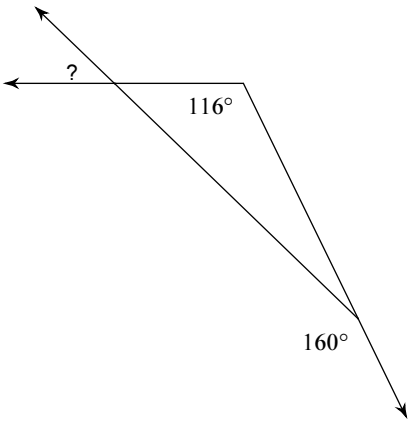

334)

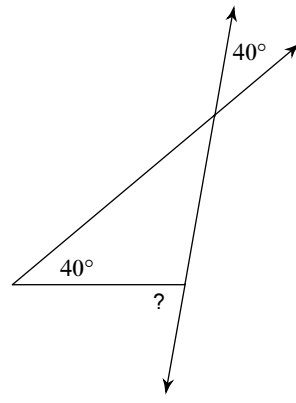

335)

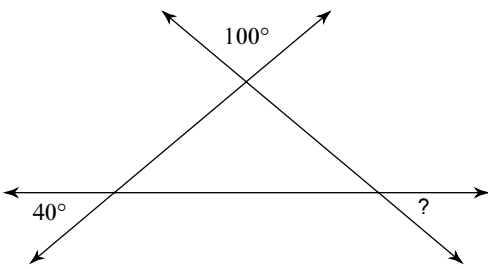

336)

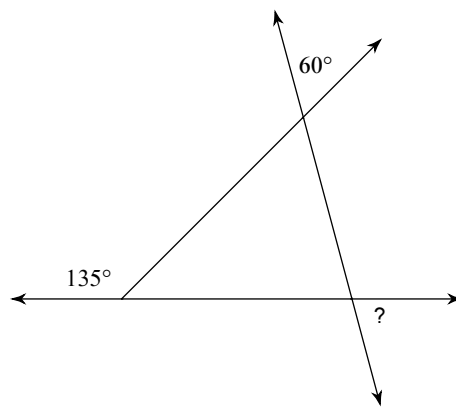

337)

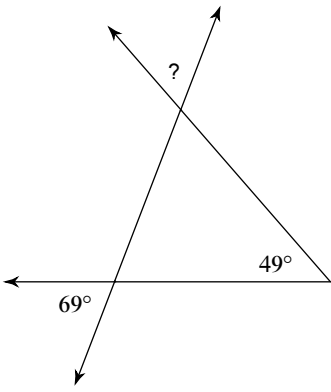

338)

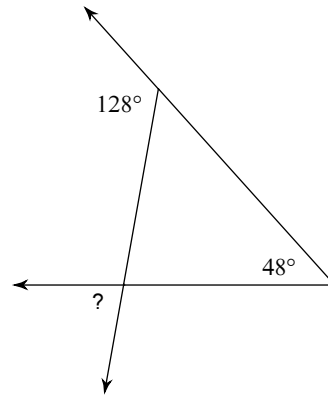

339)

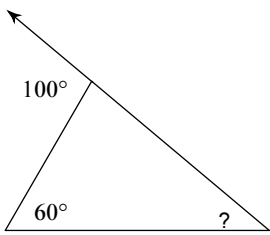

340)

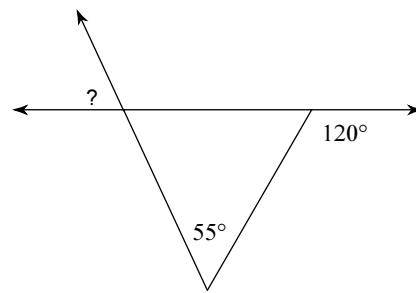

341)

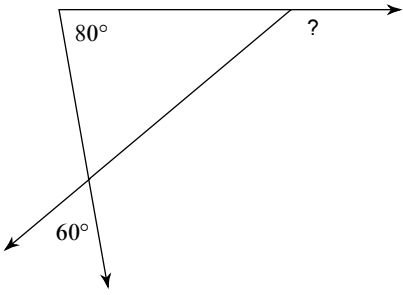

342)

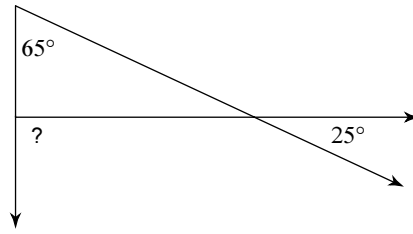

343)

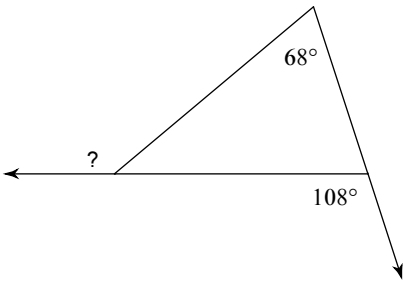

344)

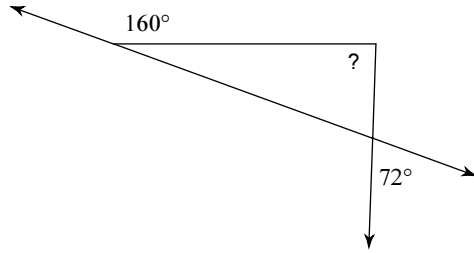

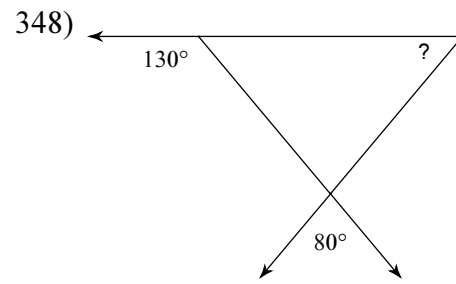
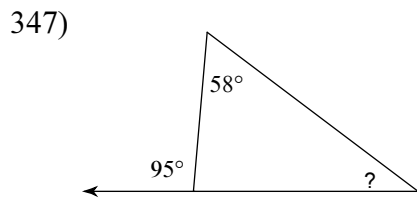
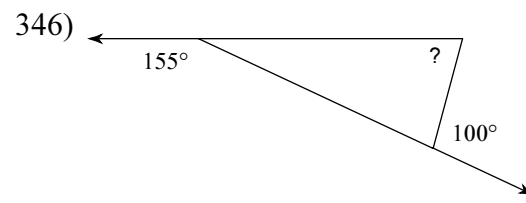
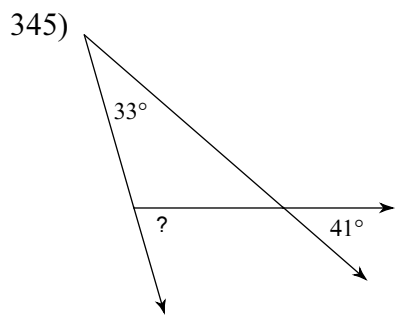

349)

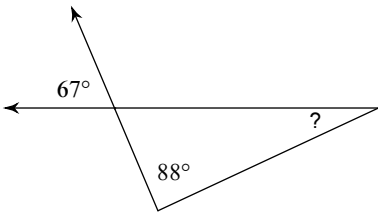

350)

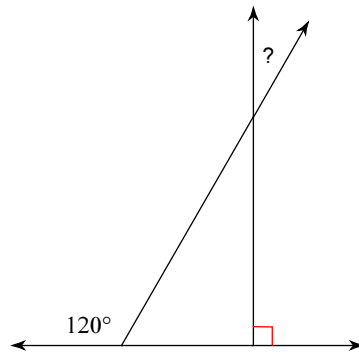

351)

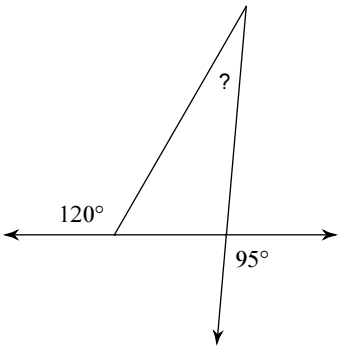

352)

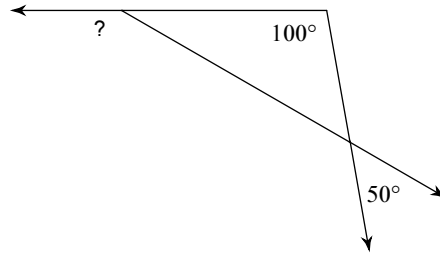

353)

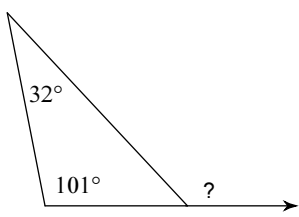

354)

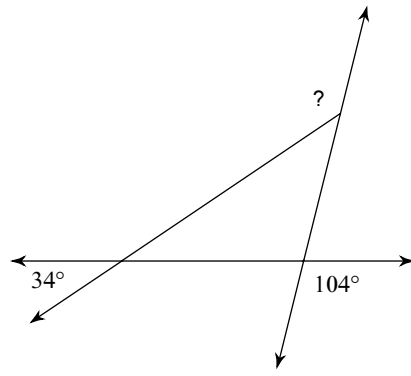

355)

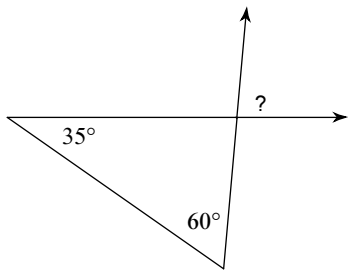

356)

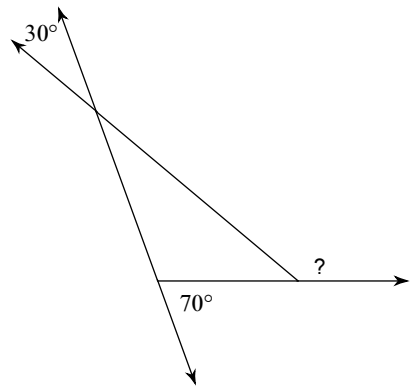

357)

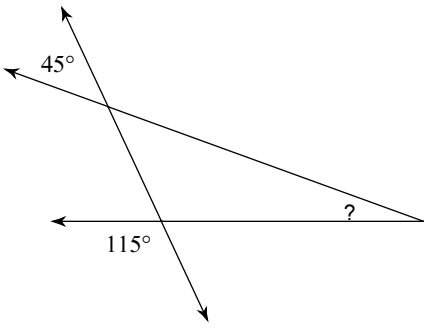

358)

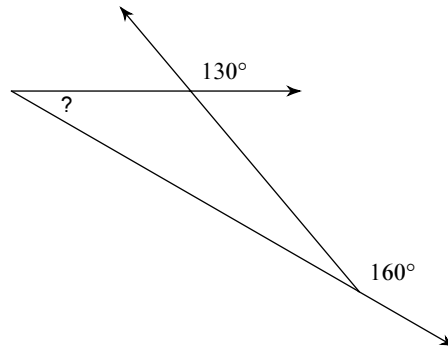

359)

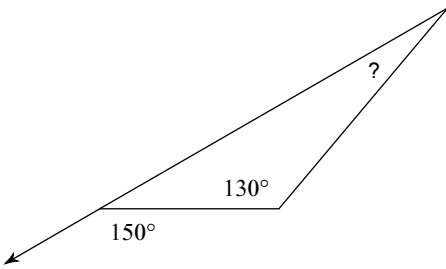

360)

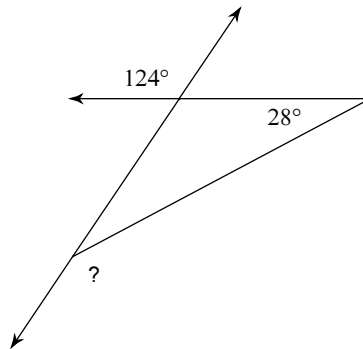

361)

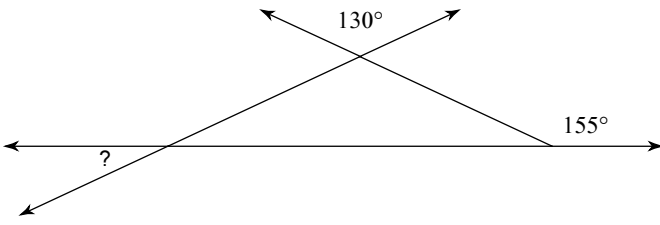

362)

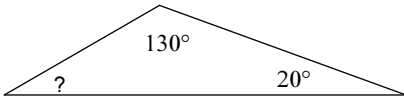

363)

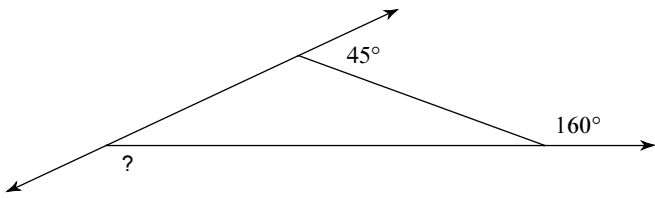

364)

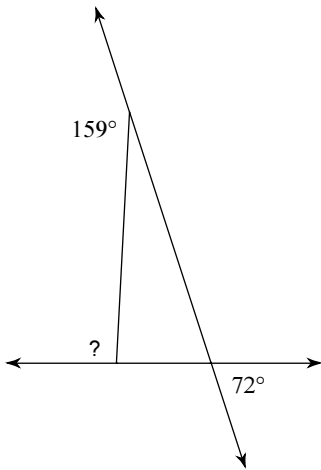

365)

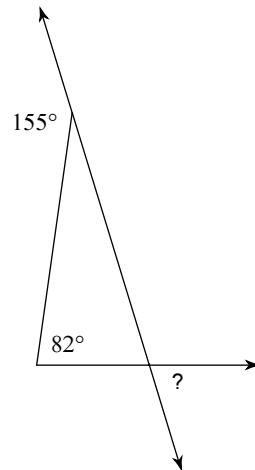

366)

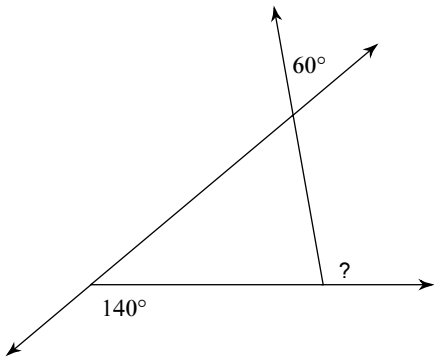

367)

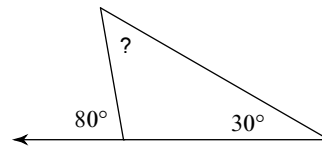

368)

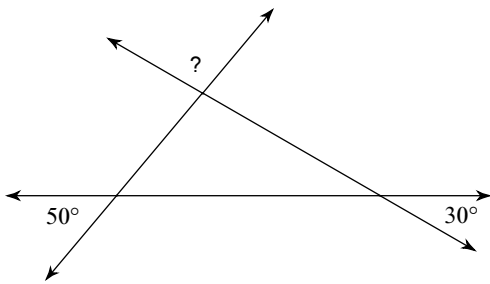

369)

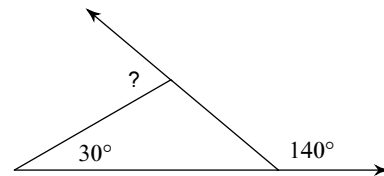

370)

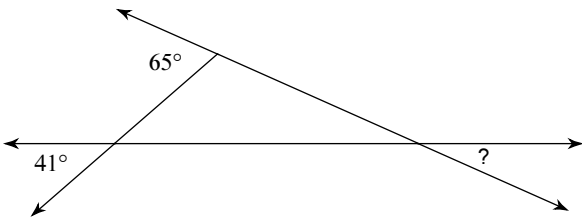

371)

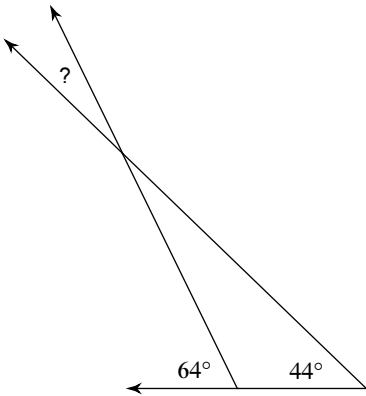

372)

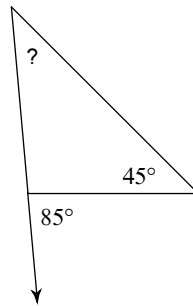

373)

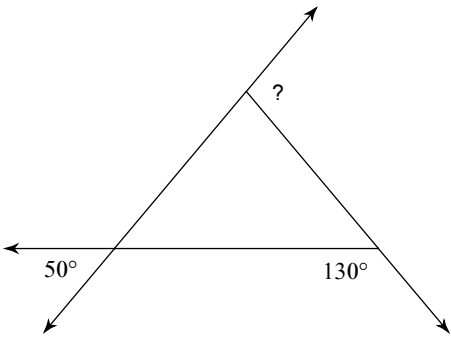

374)

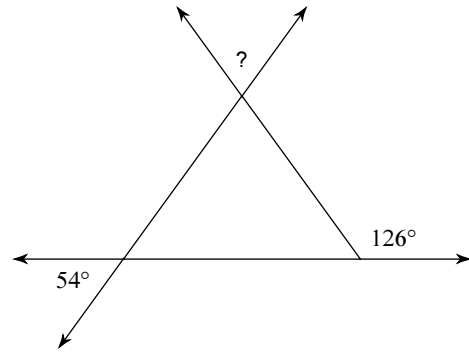

375)

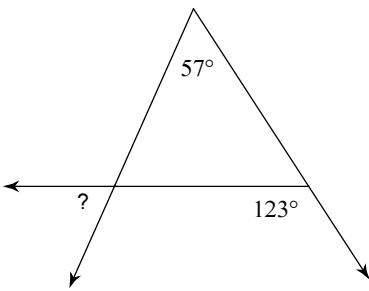

376)

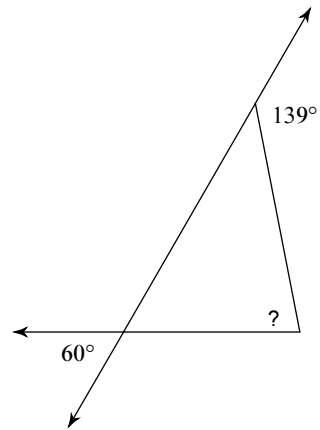

377)

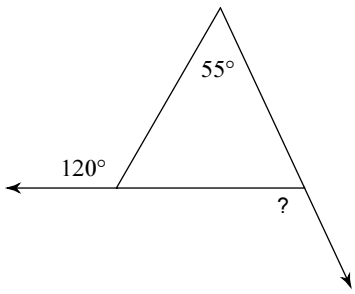

378)

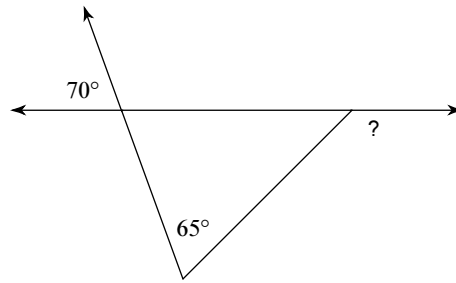

379)

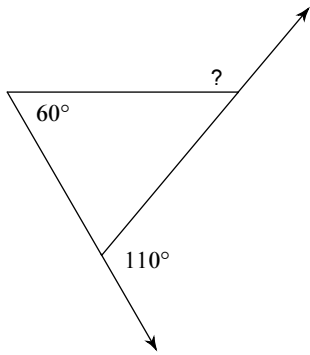

380)

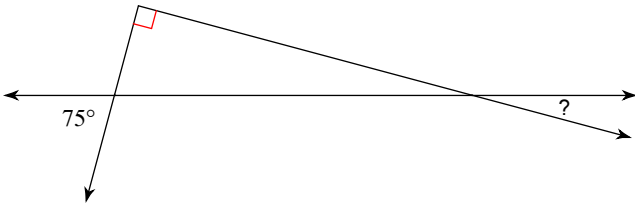

381)

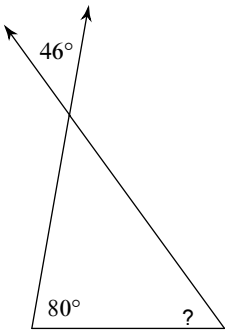

382)

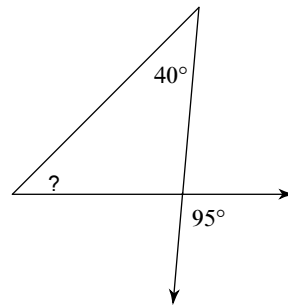

383)

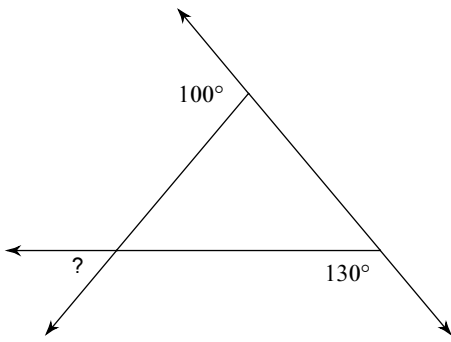

384)

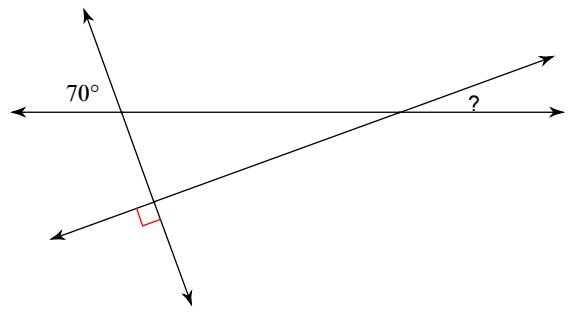

385)

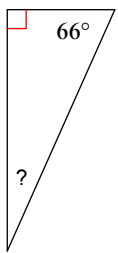

386)

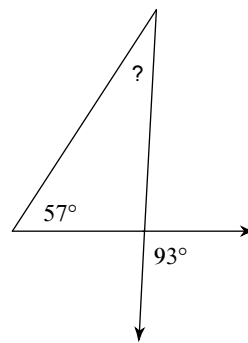

387)

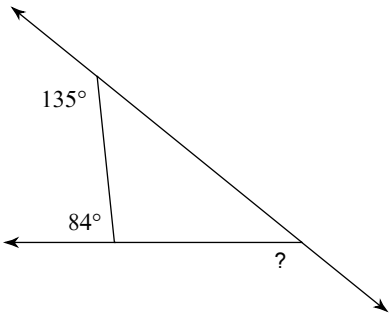

388)

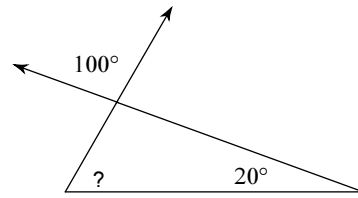

389)

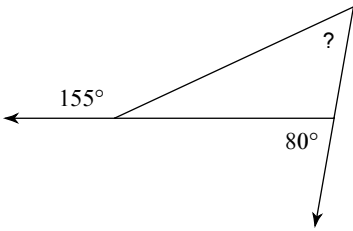

390)

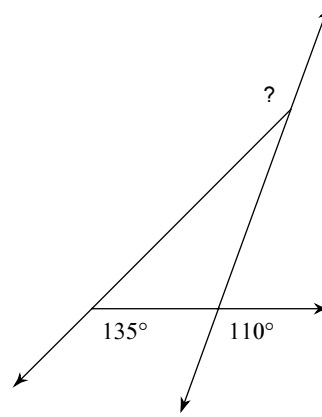

391)

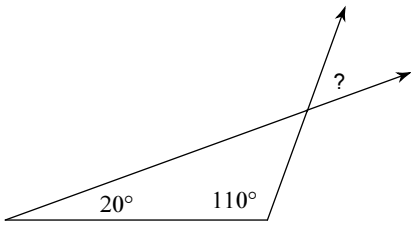

392)

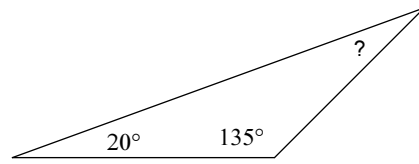

393)

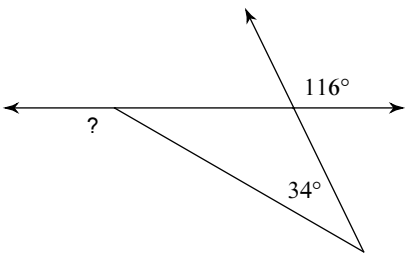

394)

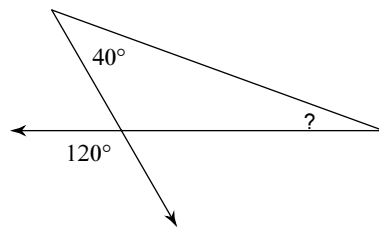

395)

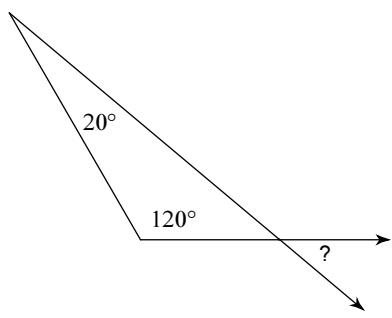

396)

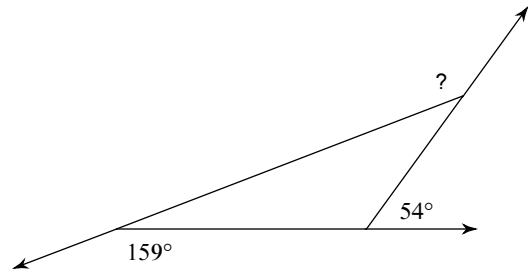

397)

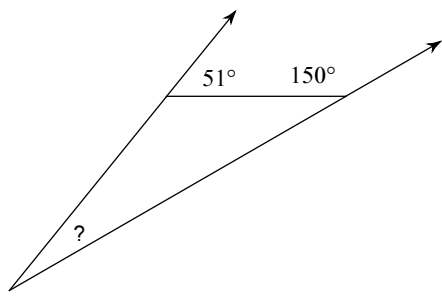

398)

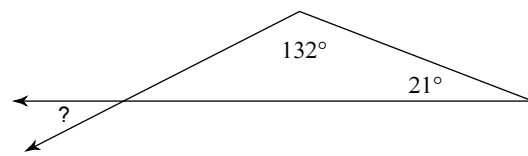

399)

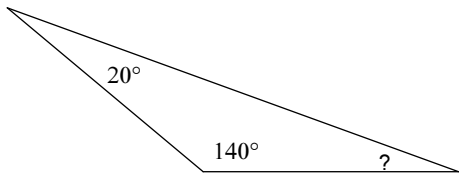

400)

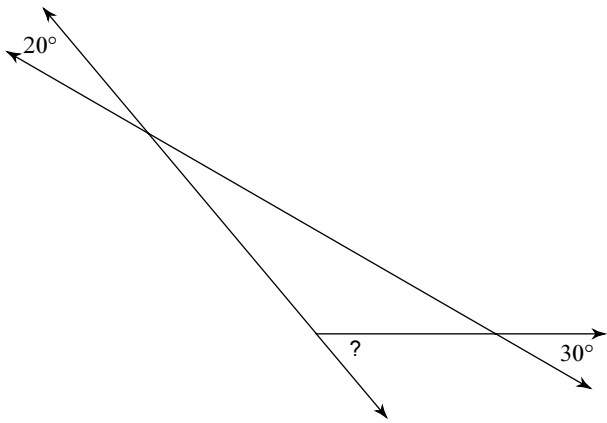

The sum of angles in a triangle - Unknown angle

Find the value of third angle

1)

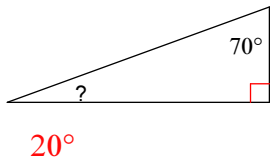

2)

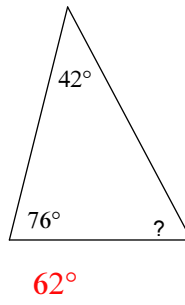

3)

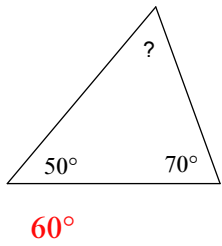

4)

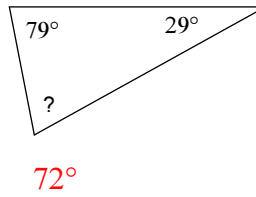

5)

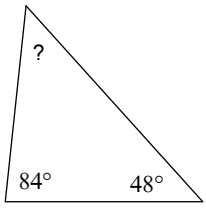

48°

6)

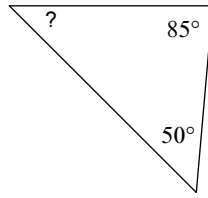

45°

7)

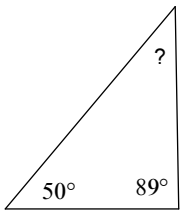

41°

8)

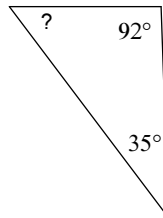

53°

9)

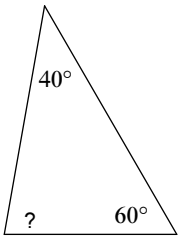

80°

10)

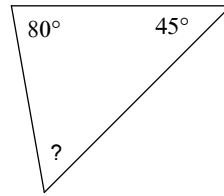

55°

11)

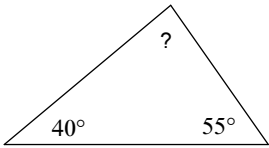

85°

12)

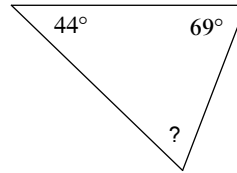

67°

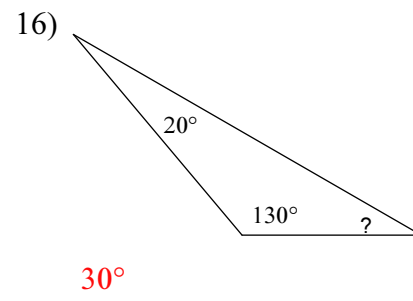
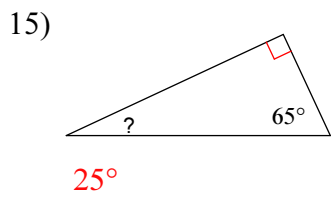
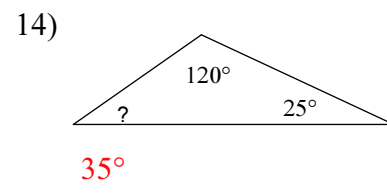
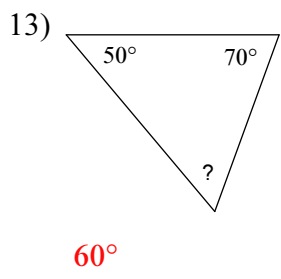

17)

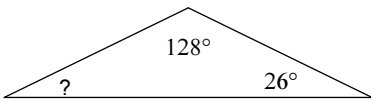

26°

18)

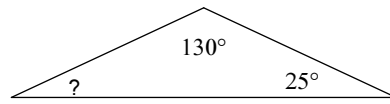

25°

19)

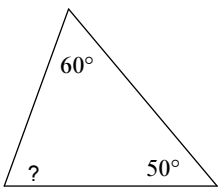

70°

20)

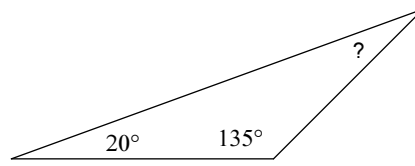

25°

21)

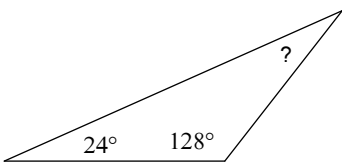

28°

22)

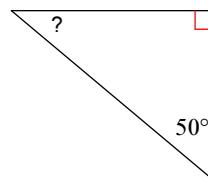

40°

23)

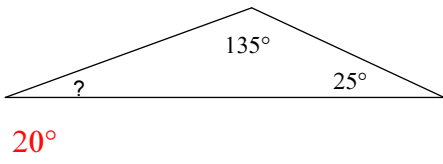

24)

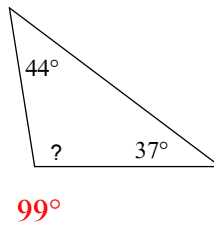

25)

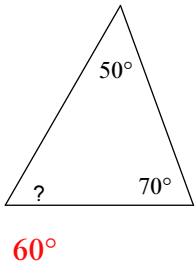

26)

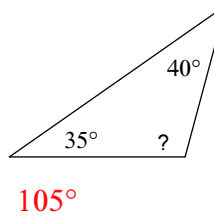

27)

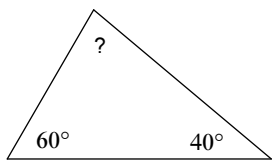

80°

28)

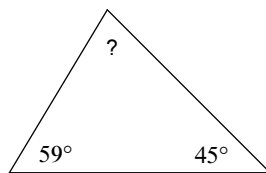

76°

29)

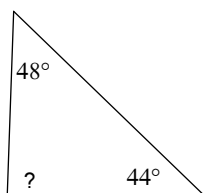

88°

30)

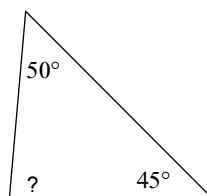

85°

31)

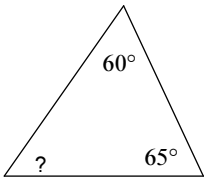

55°

32)

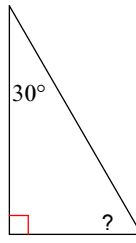

60°

33)

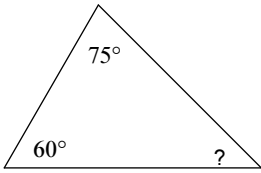

45°

34)

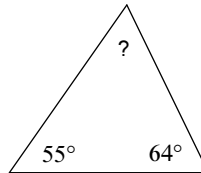

61°

35)

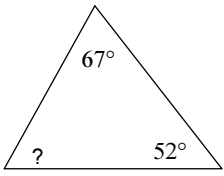

61°

36)

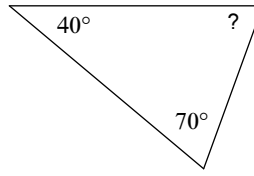

70°

37)

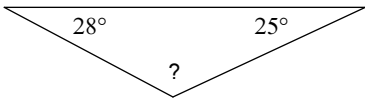

127°

38)

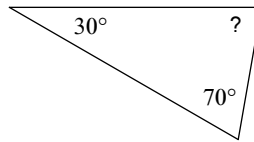

80°

39)

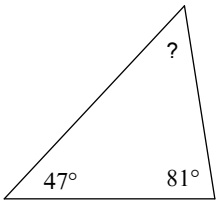

52°

40)

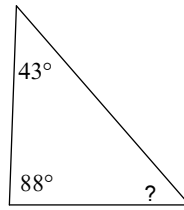

49°

41)

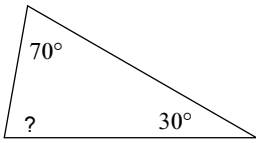

80°

42)

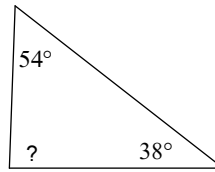

88°

43)

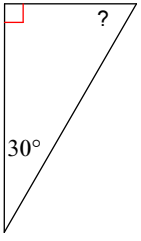

60°

44)

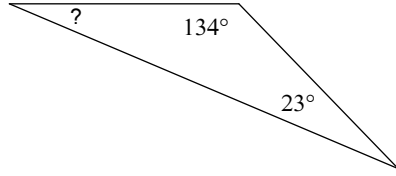

23°

45)

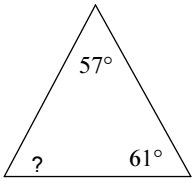

62°

46)

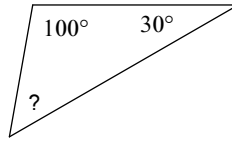

50°

47)

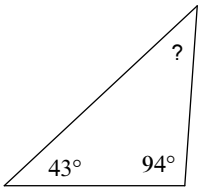

43°

48)

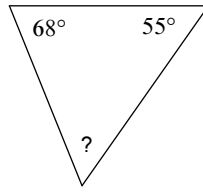

57°

49)

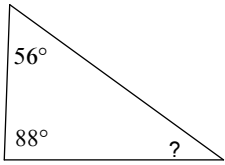

36°

50)

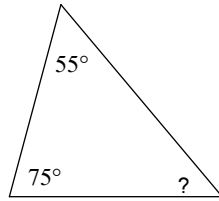

50°

51)

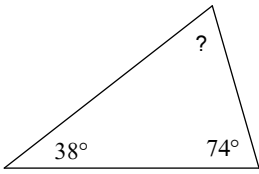

68°

52)

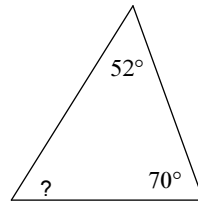

58°

53)

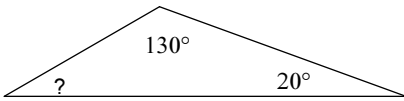

30°

54)

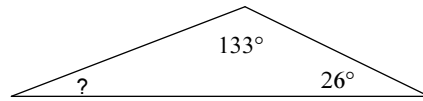

21°

55)

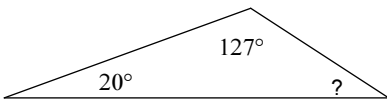

33°

56)

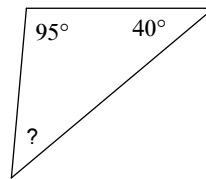

45°

57)

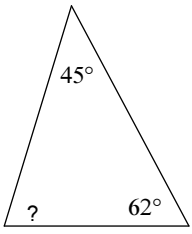

73°

58)

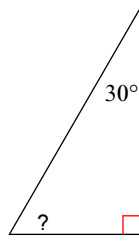

60°

59)

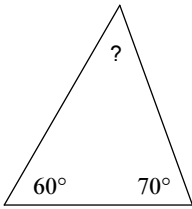

50°

60)

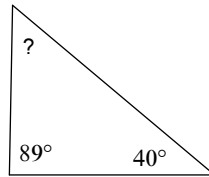

51°

61)

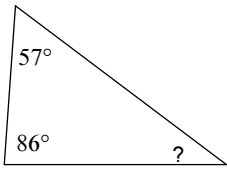

37°

62)

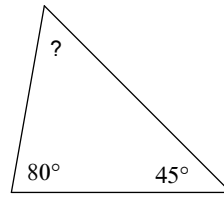

55°

63)

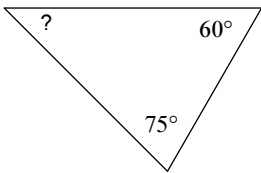

45°

64)

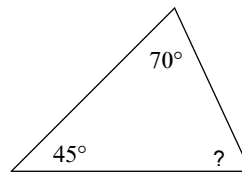

65°

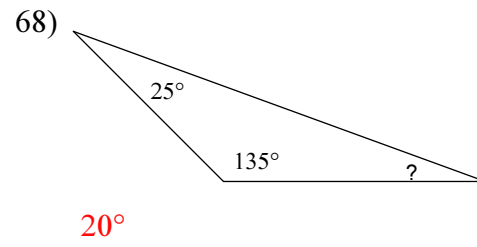
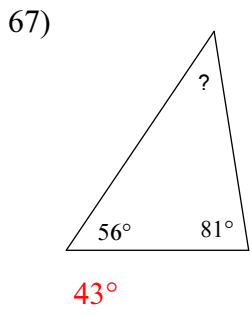
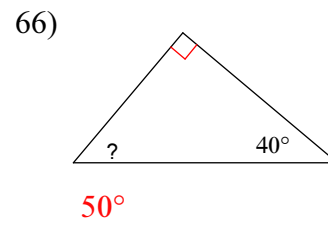
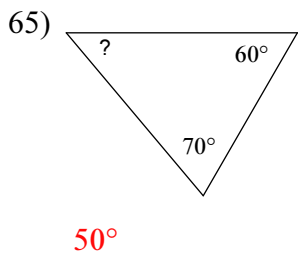

69)

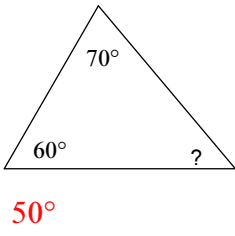

70)

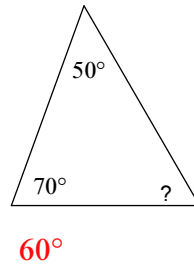

71)

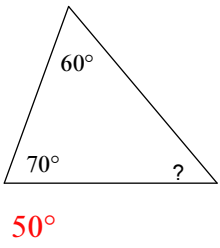

72)

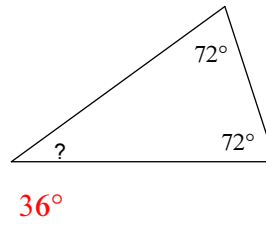

73)

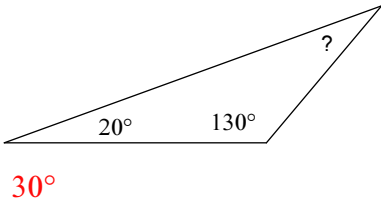

74)

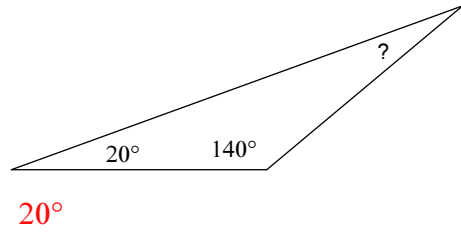

75)

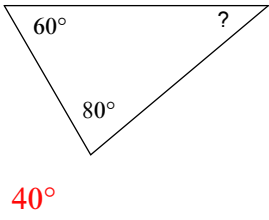

76)

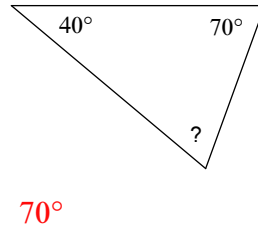

77)

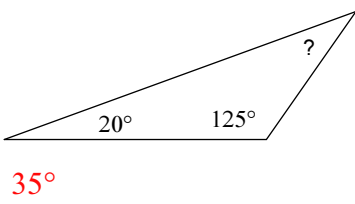

78)

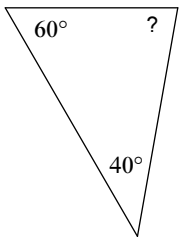

80°

79)

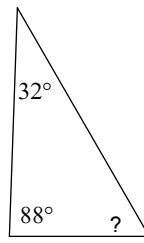

60°

80)

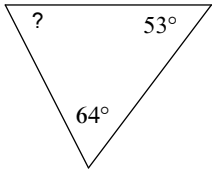

63°

81)

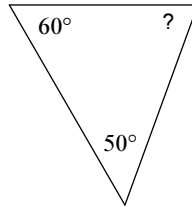

70°

82)

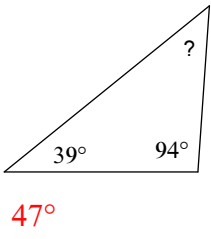

83)

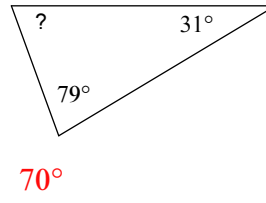

84)

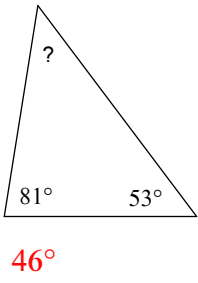

85)

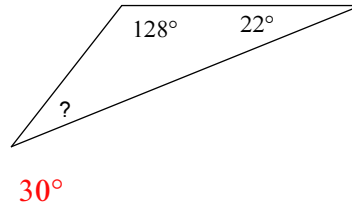

86)

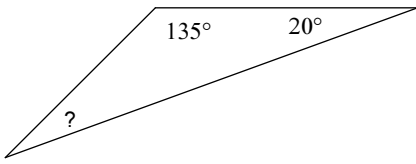

25°

87)

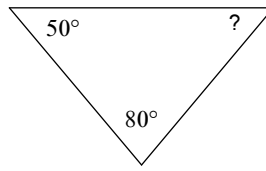

50°

88)

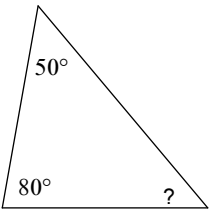

50°

89)

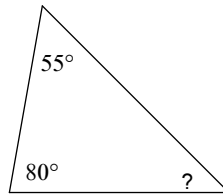

45°

90)

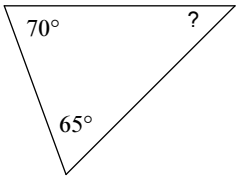

45°

91)

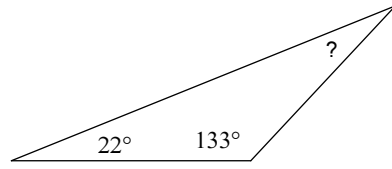

25°

92)

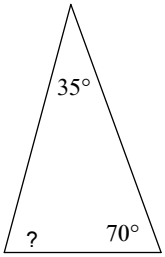

75°

93)

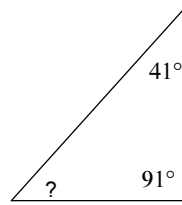

48°

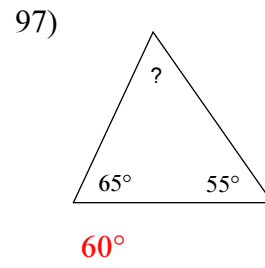
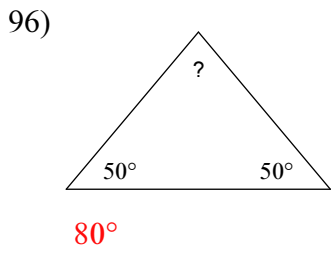
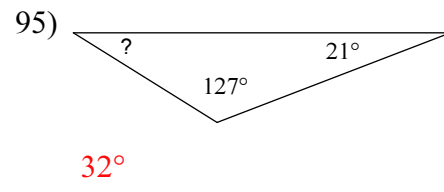
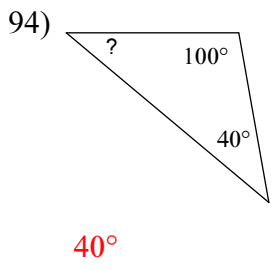

98)

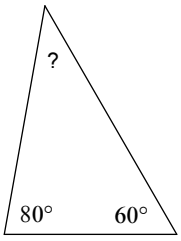

40°

99)

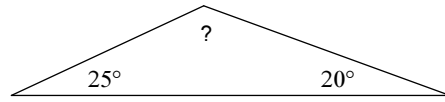

135°

100)

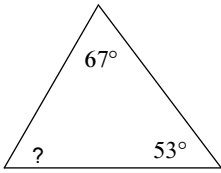

60°

101)

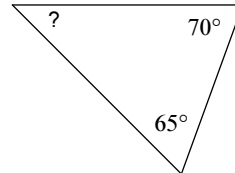

45°

102)

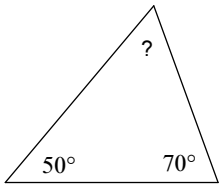

60°

103)

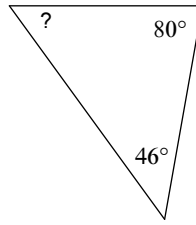

54°

104)

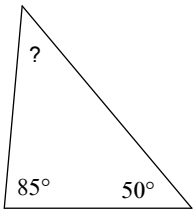

45°

105)

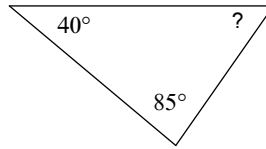

55°

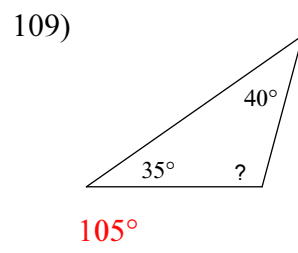
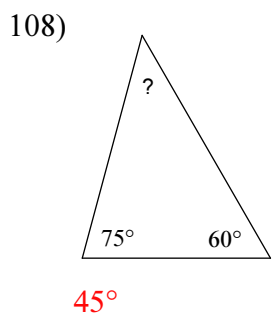
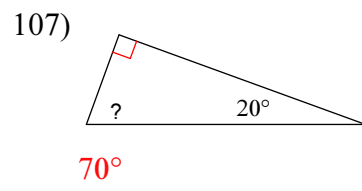
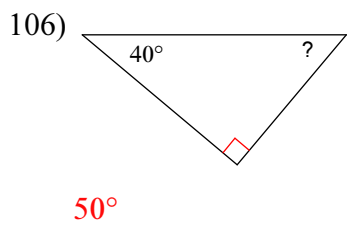

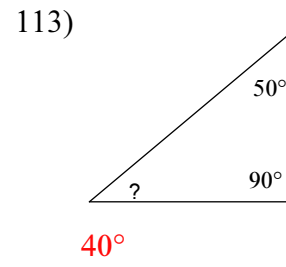
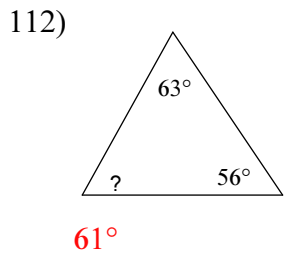
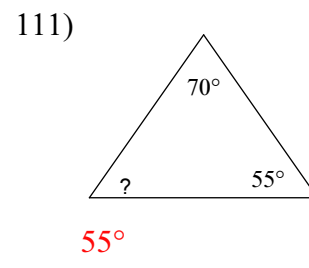
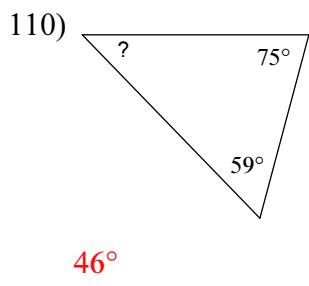

114)

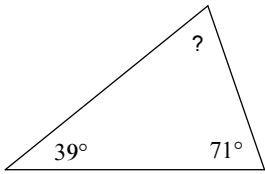

70°

115)

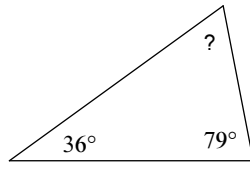

65°

116)

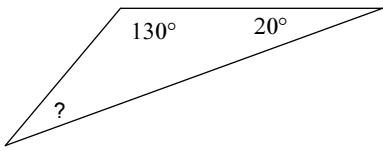

30°

117)

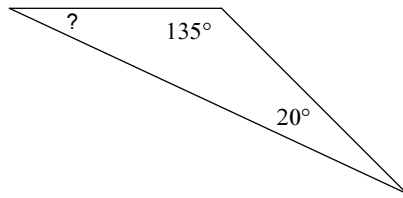

25°

118)

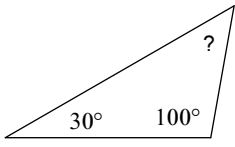

50°

119)

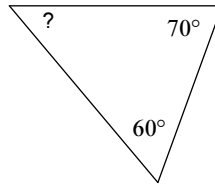

50°

120)

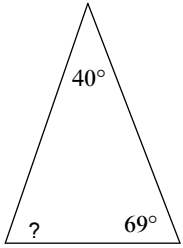

71°

121)

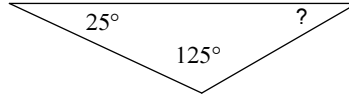

30°

122)

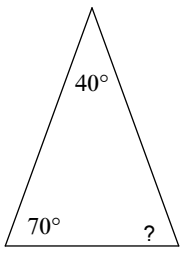

70°

123)

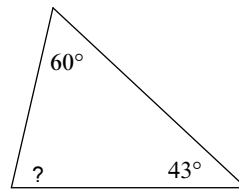

77°

124)

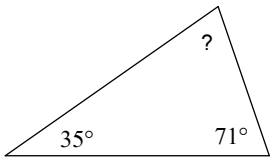

74°

125)

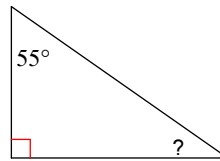

35°

126)

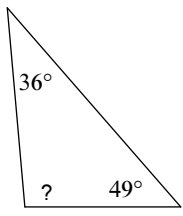

95°

127)

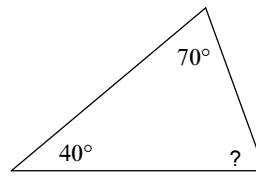

70°

128)

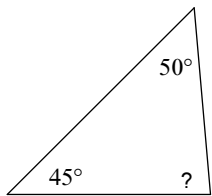

85°

129)

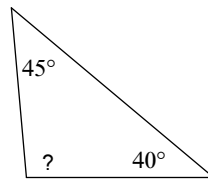

95°

130)

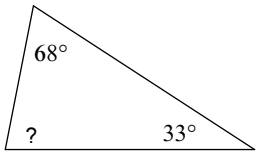

79°

131)

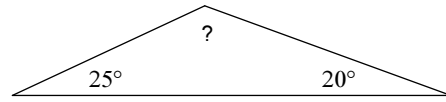

135°

132)

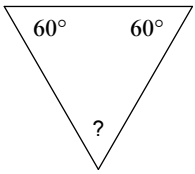

60°

133)

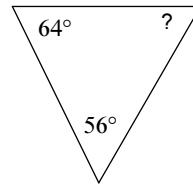

60°

134)

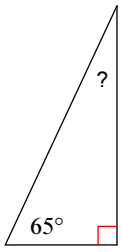

25°

135)

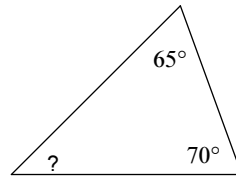

45°

136)

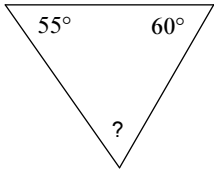

65°

137)

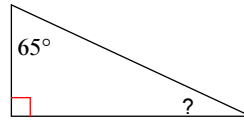

25°

138)

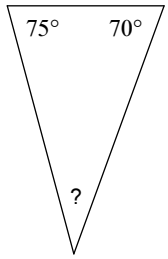

35°

139)

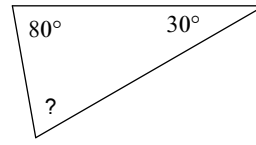

70°

140)

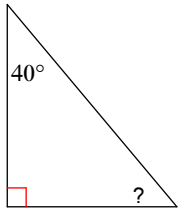

50°

141)

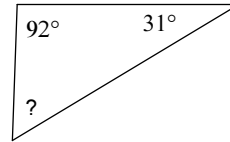

57°

142)

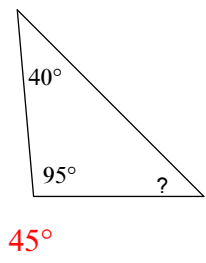

143)

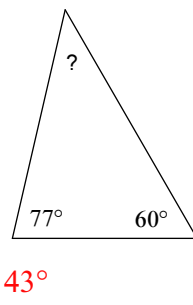

144)

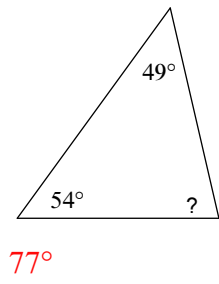

145)

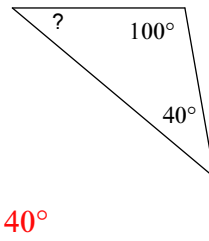

146)

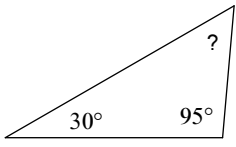

55°

147)

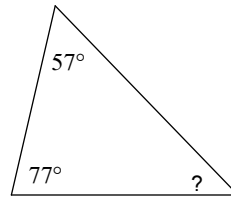

46°

148)

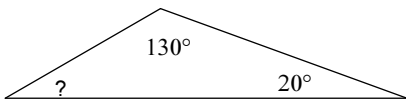

30°

149)

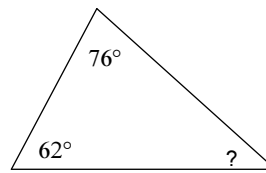

42°

150)

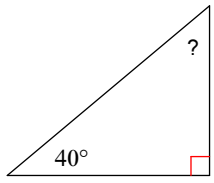

50°

151)

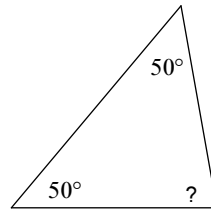

80°

152)

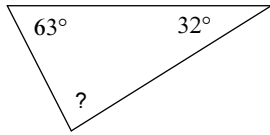

85°

153)

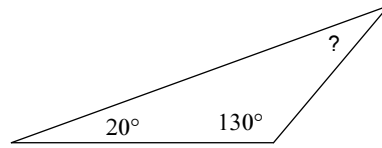

30°

154)

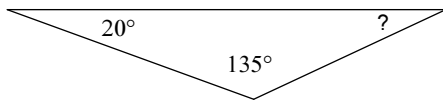

25°

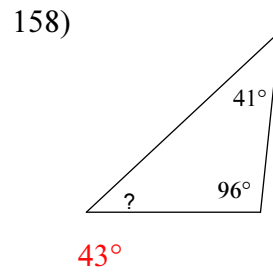
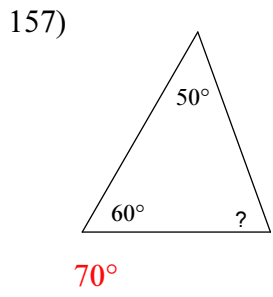
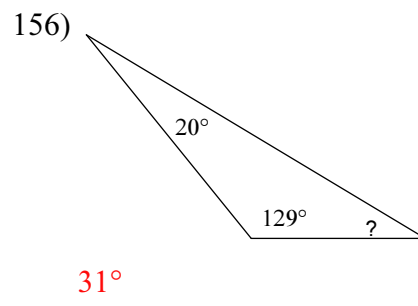
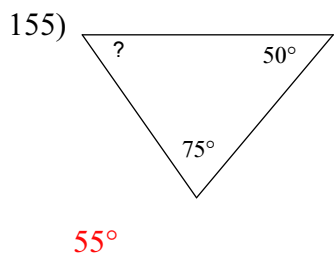

159)

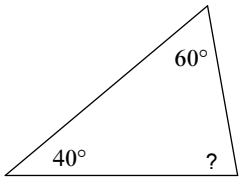

80°

160)

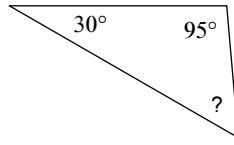

55°

161)

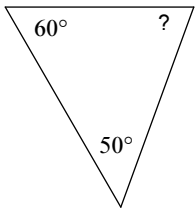

70°

162)

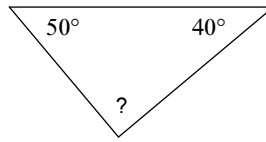

90°

163)

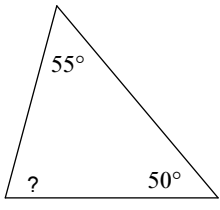

75°

164)

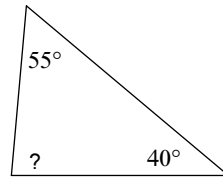

85°

165)

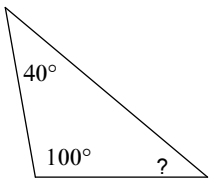

40°

166)

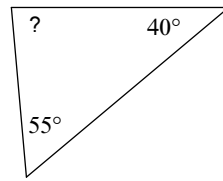

85°

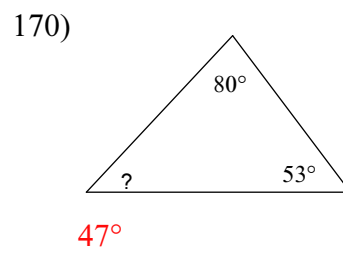
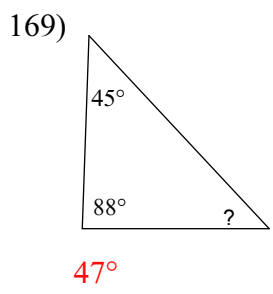
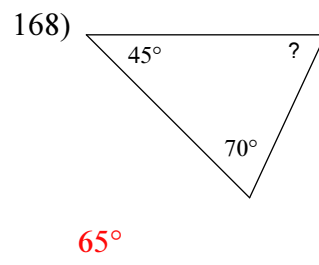
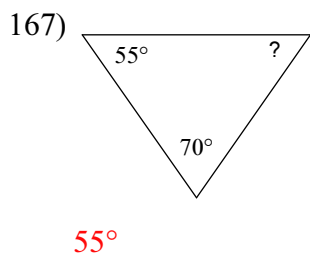

171)

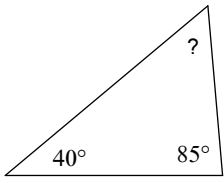

55°

172)

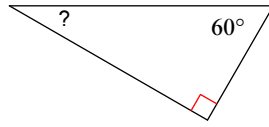

30°

173)

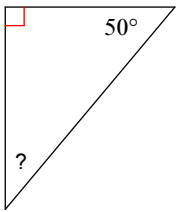

40°

174)

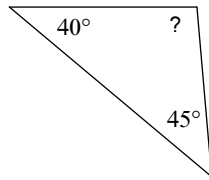

95°

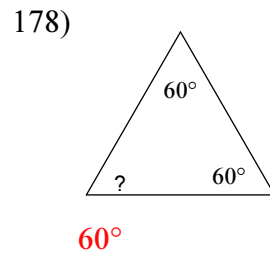
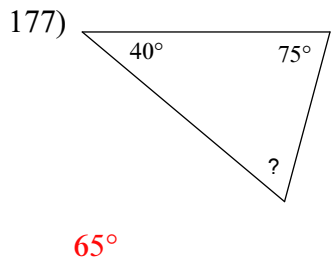
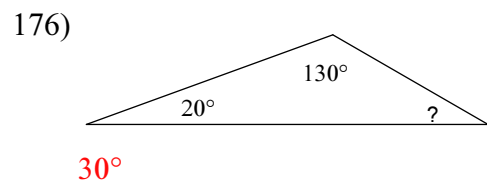
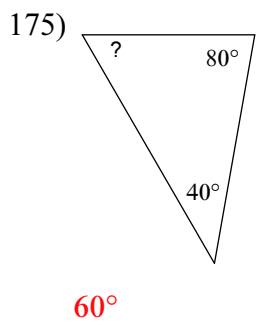

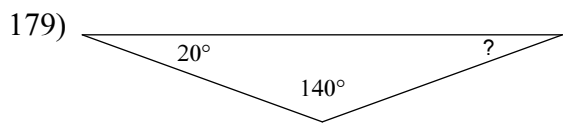

20°

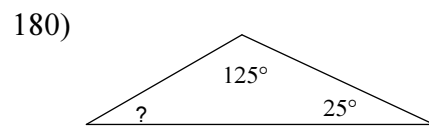

30°

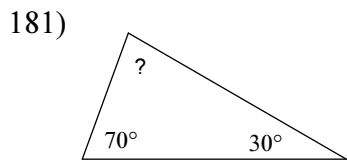

80°

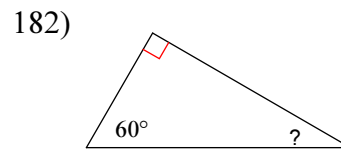

30°

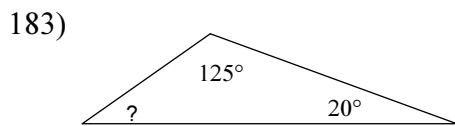

35°

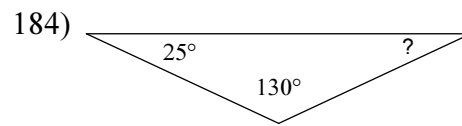

25°

185)

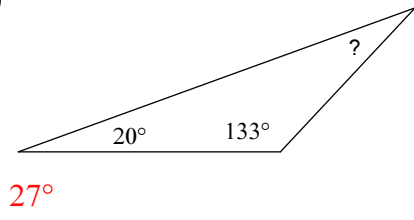

186)

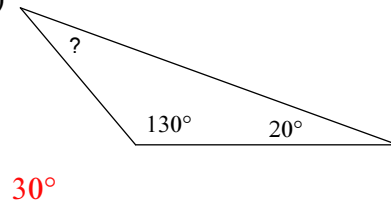

187)

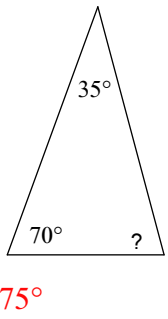

188)

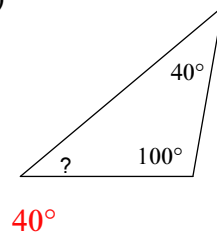

189)

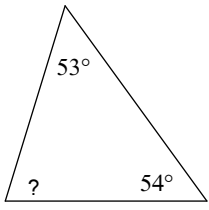

73°

190)

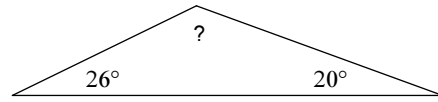

134°

191)

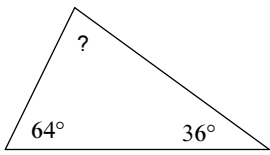

80°

192)

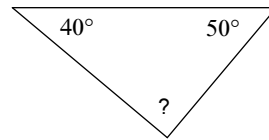

90°

193)

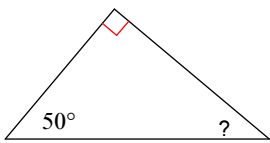

40°

194)

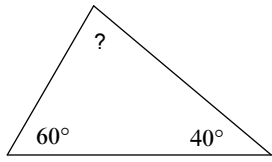

80°

195)

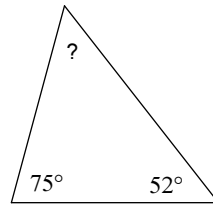

53°

196)

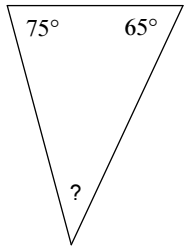

40°

197)

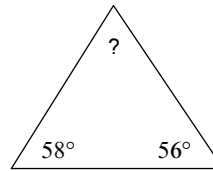

66°

198)

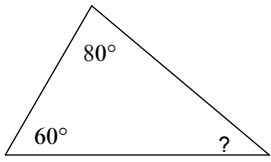

40°

199)

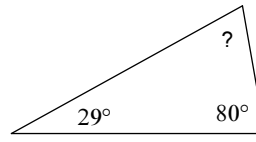

71°

200)

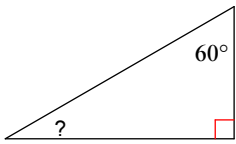

30°

201)

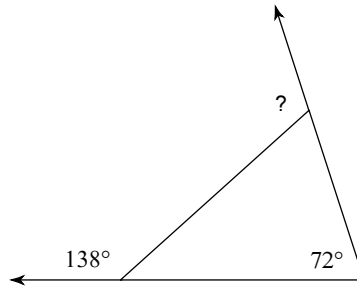

114°

202)

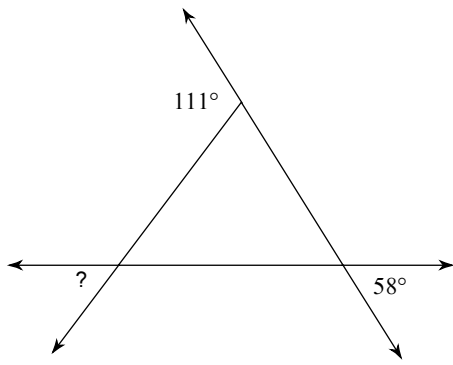

53°

203)

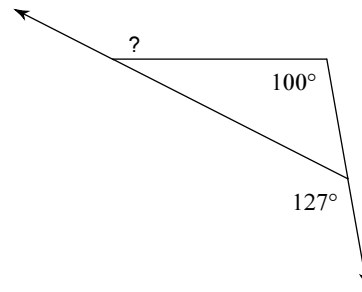

153°

204)

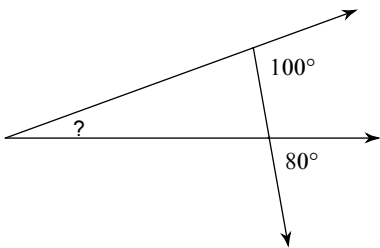

20°

205)

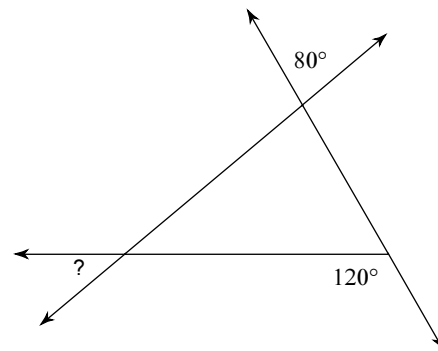

40°

206)

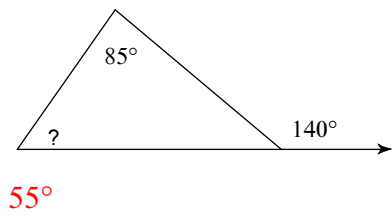

207)

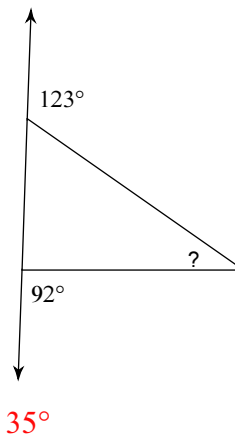

208)

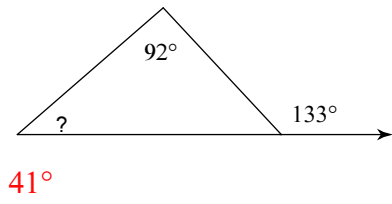

209)

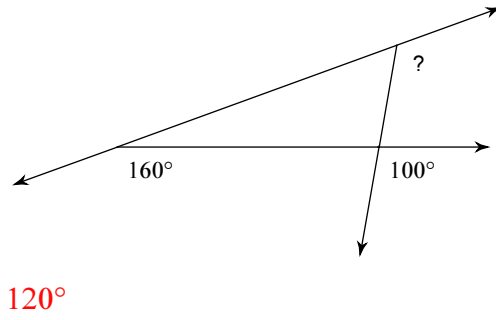

210)

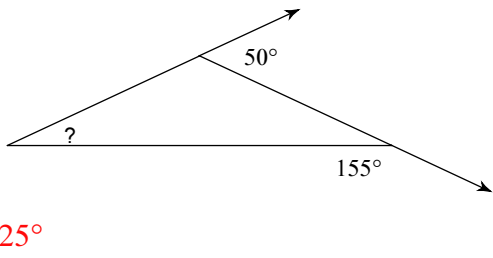

211)

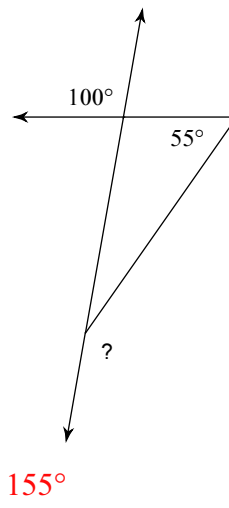

212)

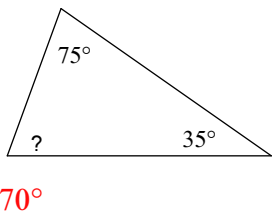

213)

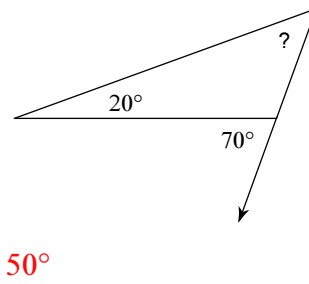

214)

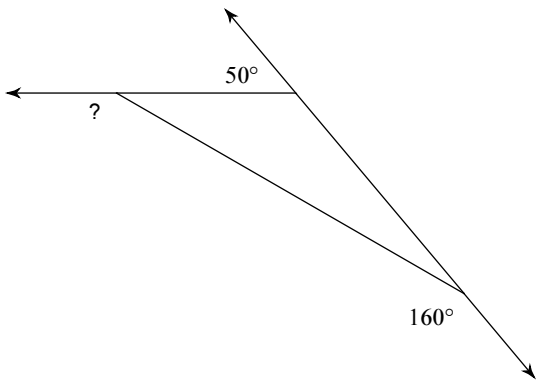

150°

215)

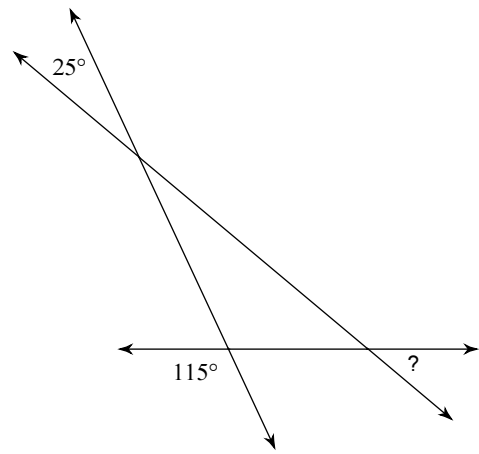

40°

216)

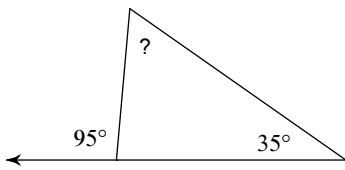

60°

217)

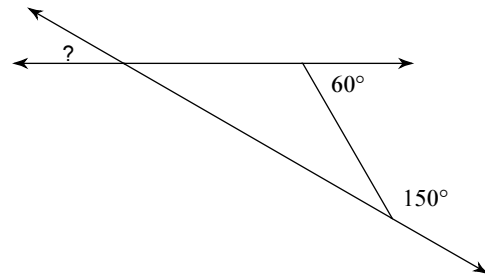

30°

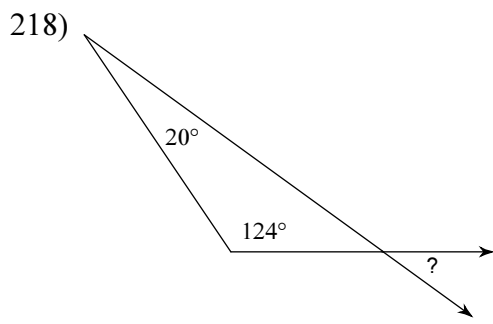

36°

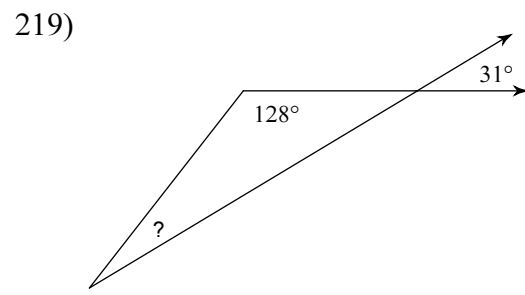

21°

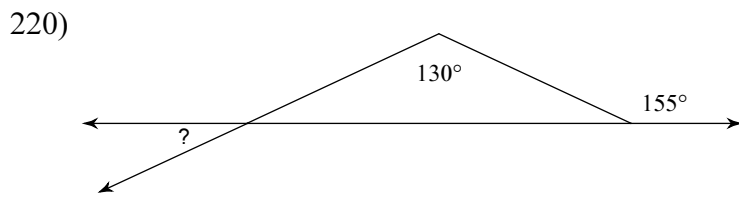

25°

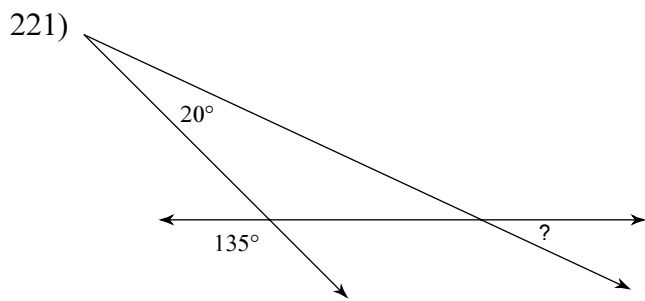

25°

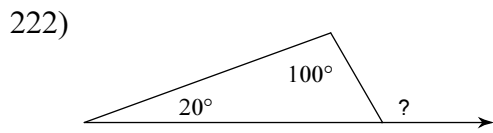

120°

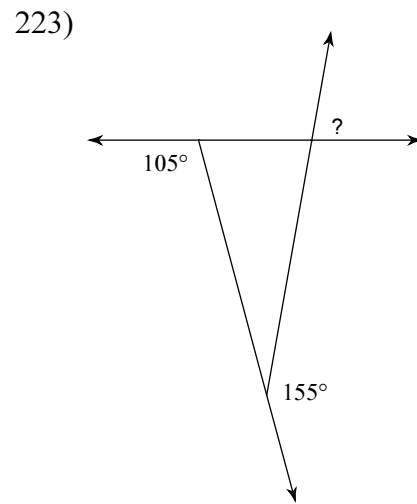

80°

224)

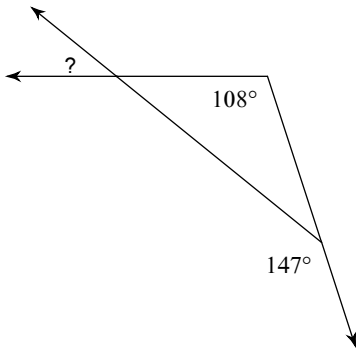

39°

225)

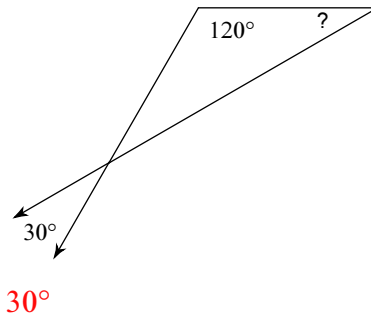

30°

226)

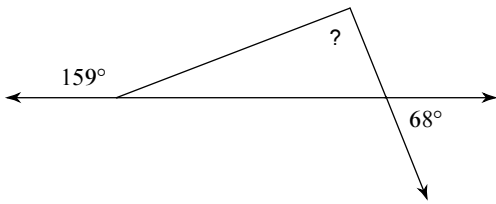

91°

227)

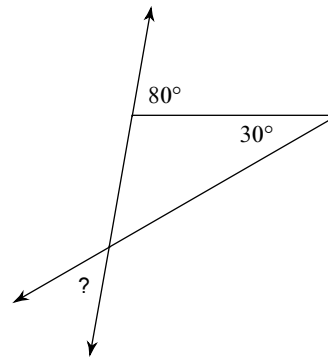

50°

228)

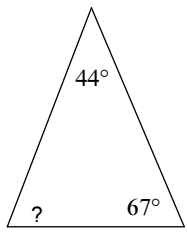

69°

229)

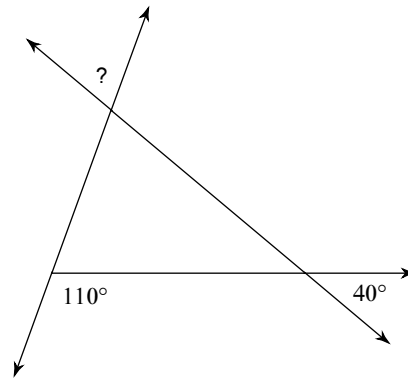

70°

230)

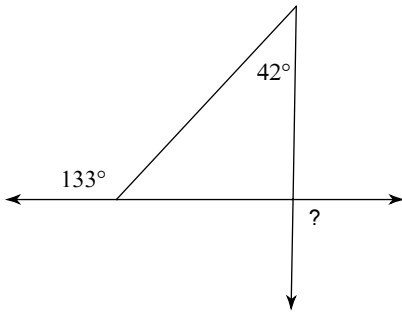

91°

231)

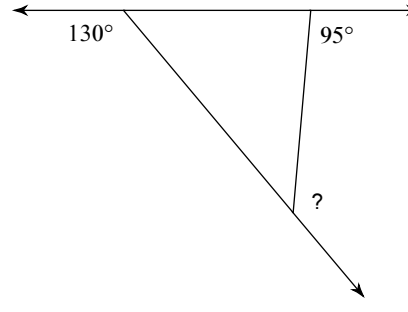

135°

232)

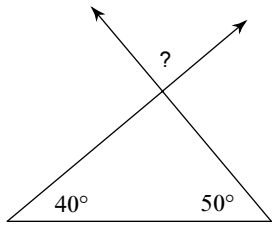

90°

233)

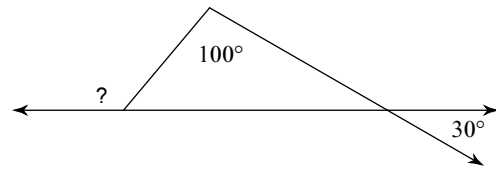

130°

234)

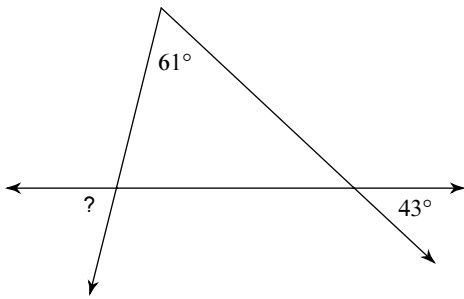

76°

235)

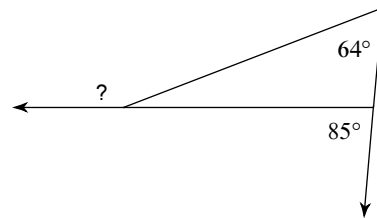

159°

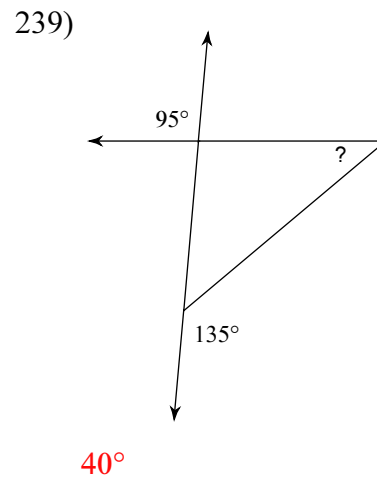
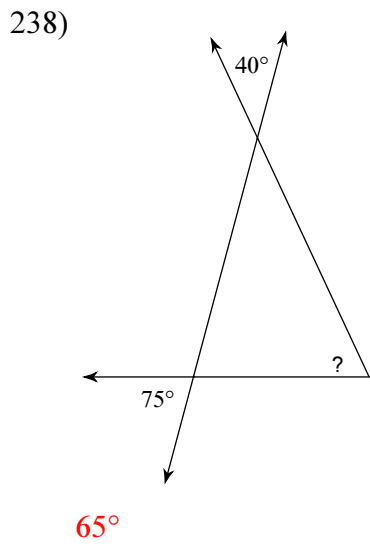
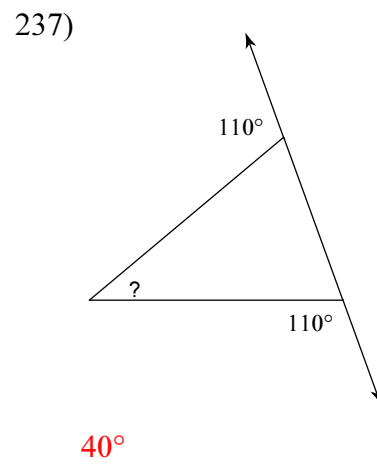
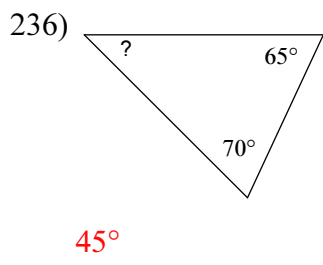

240)

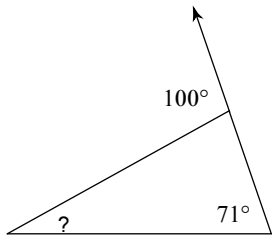

29°

241)

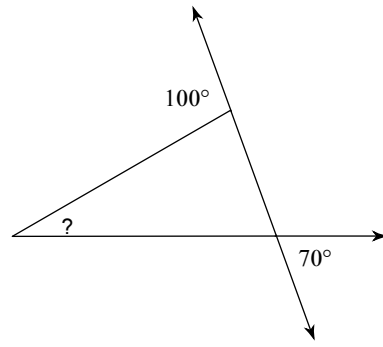

30°

242)

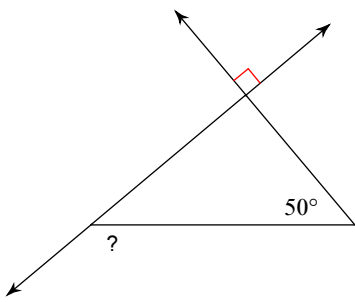

140°

243)

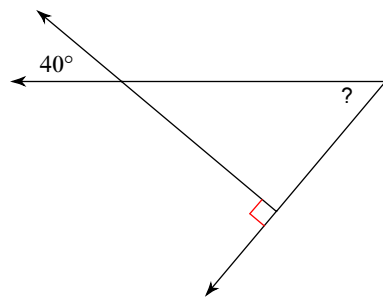

50°

244)

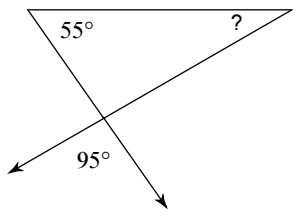

30°

245)

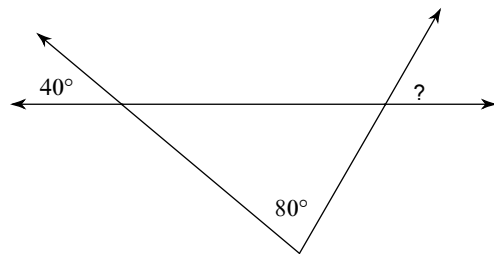

60°

246)

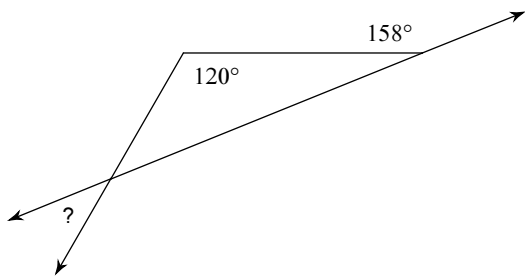

38°

247)

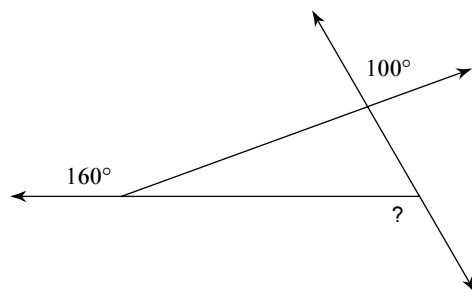

120°

248)

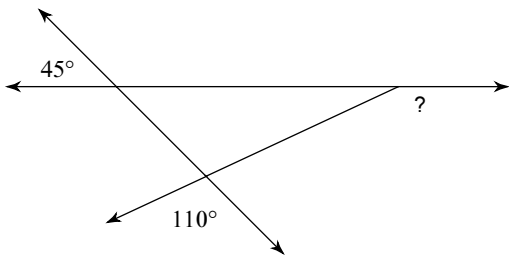

155°

249)

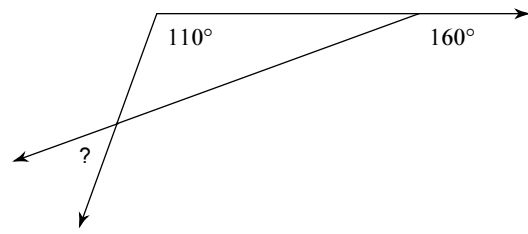

50°

250)

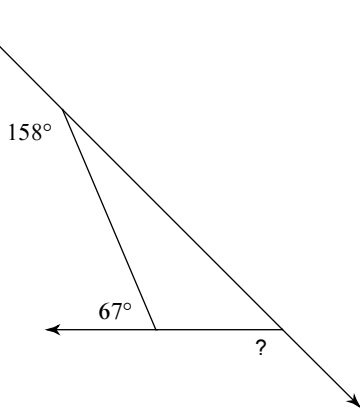

135°

251)

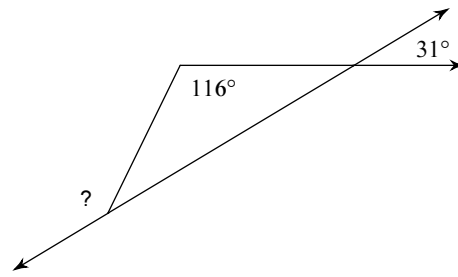

147°

252)

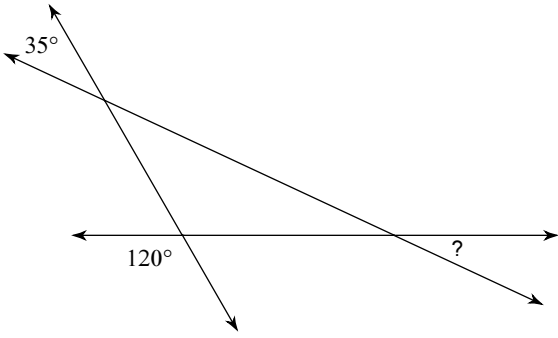

25°

253)

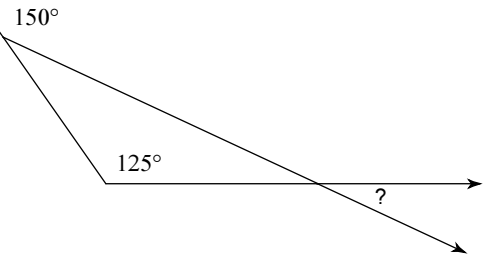

25°

254)

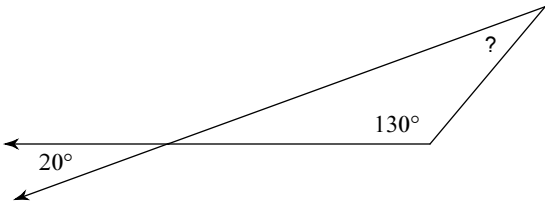

30°

255)

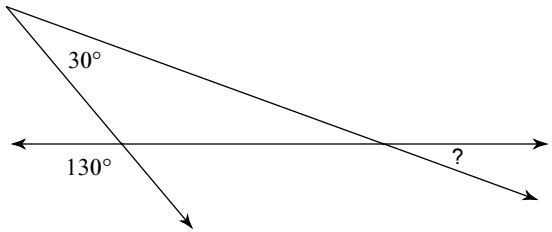

20°

256)

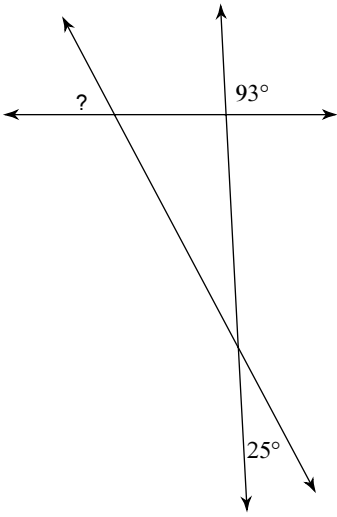

62°

257)

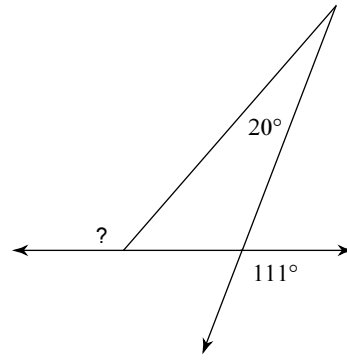

131°

258)

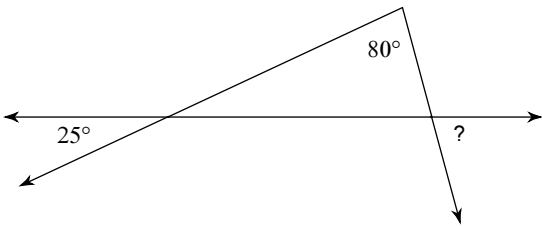

75°

259)

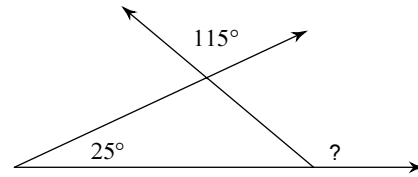

140°

260)

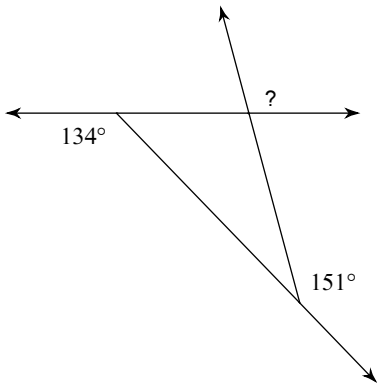

105°

261)

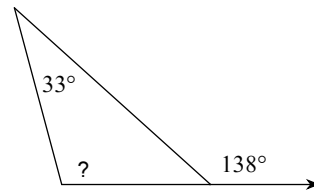

105°

262)

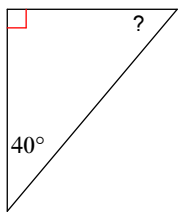

50°

263)

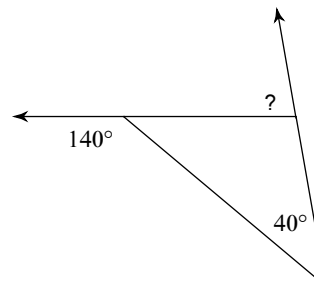

80°

264)

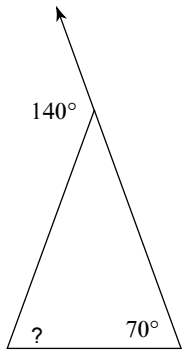

70°

265)

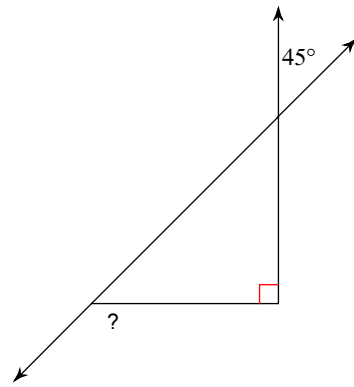

135°

266)

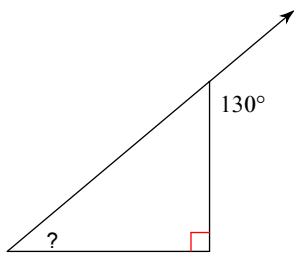

40°

267)

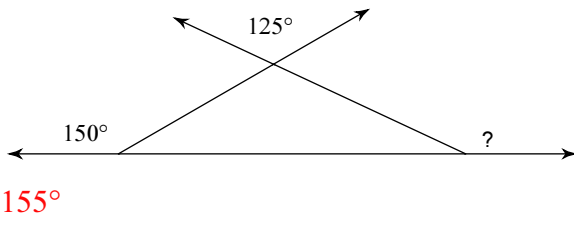

268)

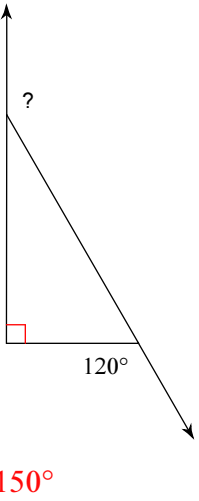

269)

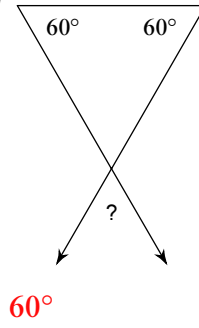

270)

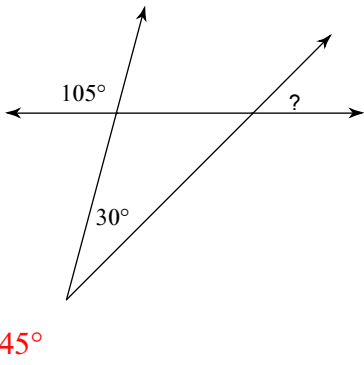

271)

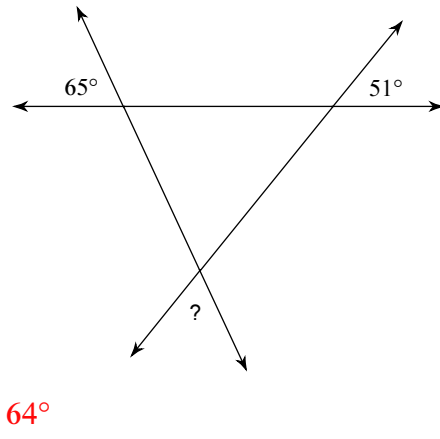

272)

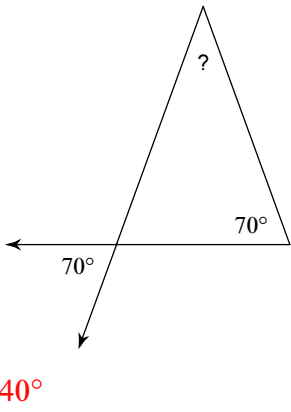

273)

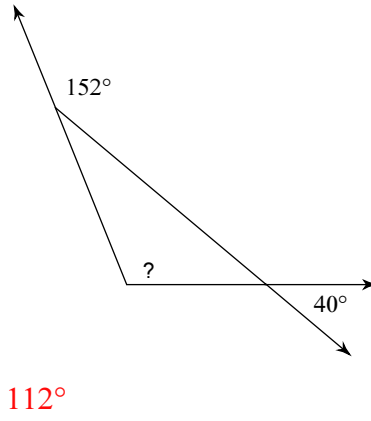

274)

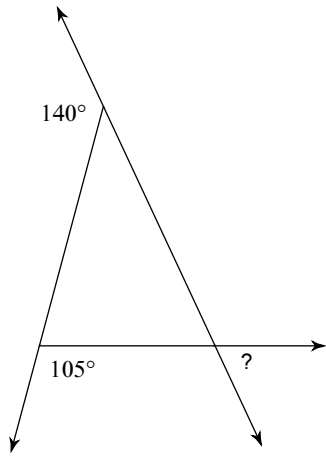

65°

275)

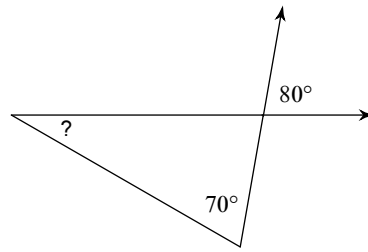

30°

276)

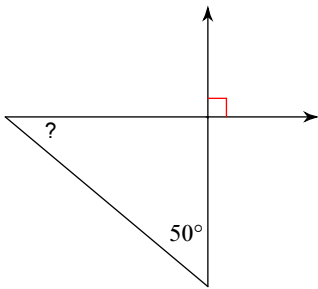

40°

277)

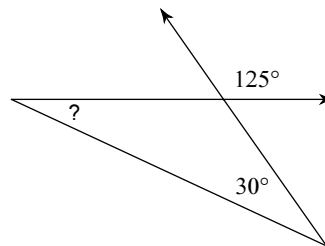

25°

278)

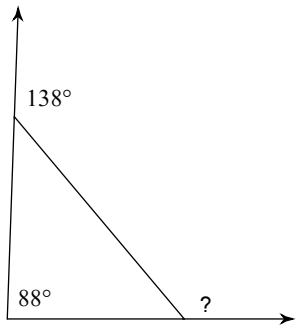

130°

279)

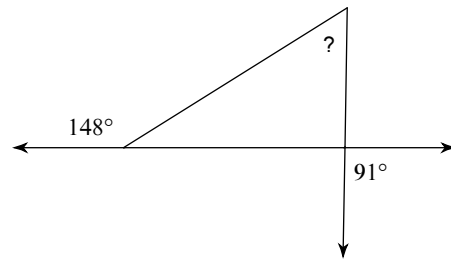

57°

280)

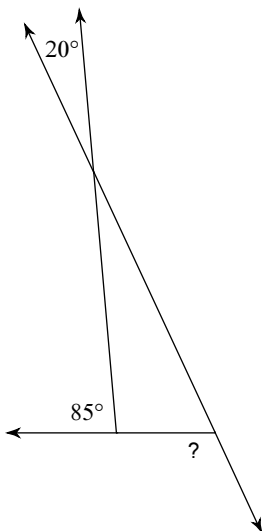

115°

281)

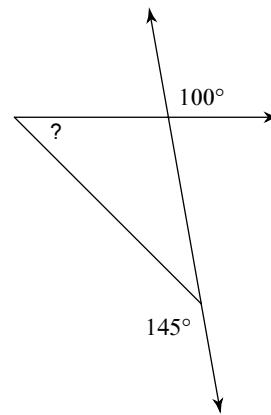

45°

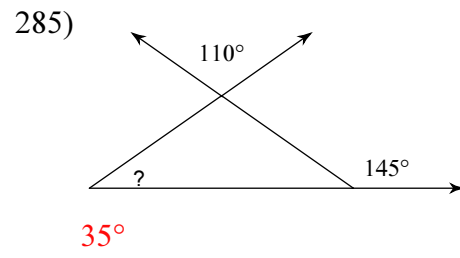
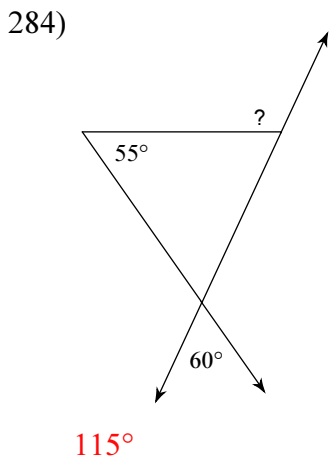
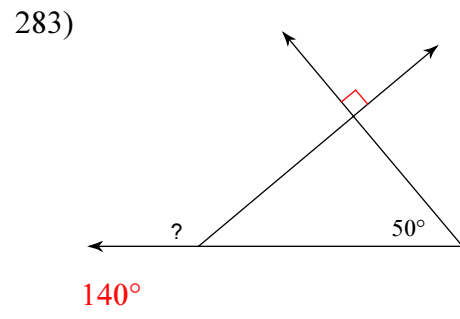
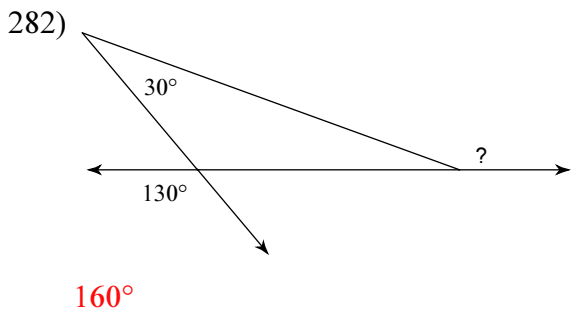

286)

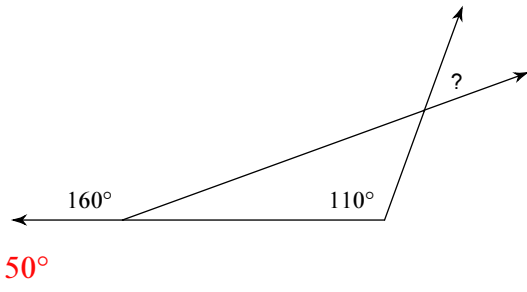

287)

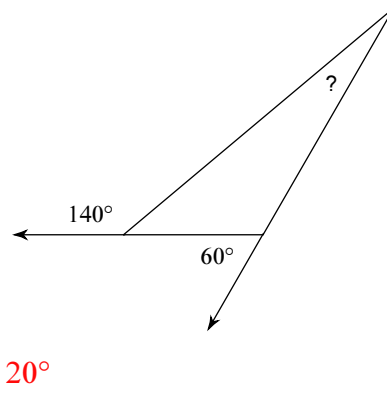

288)

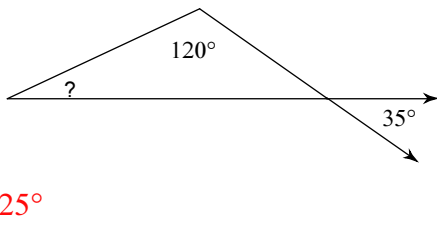

289)

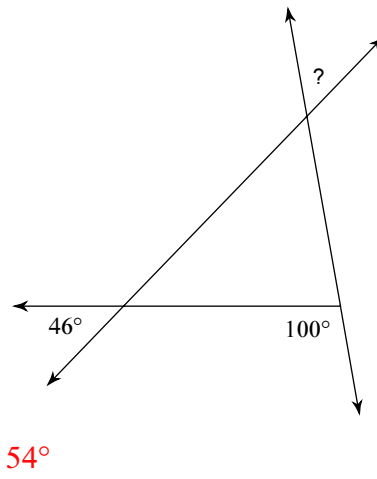

290)

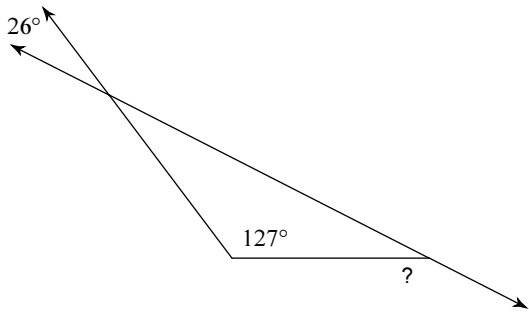

153°

291)

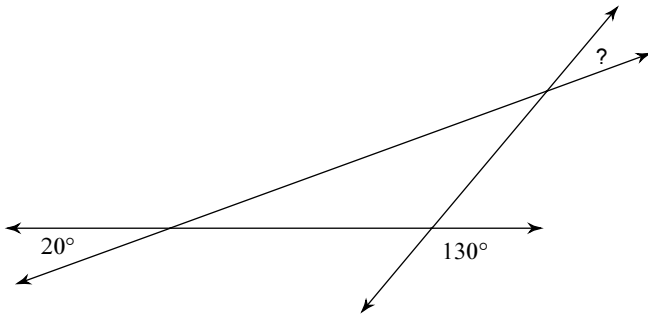

30°

292)

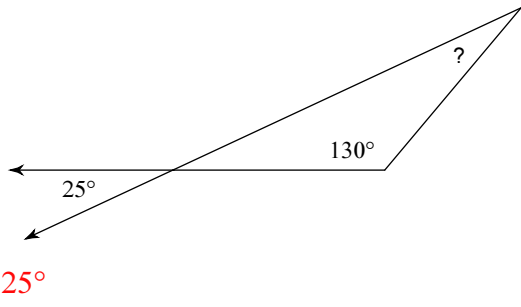

293)

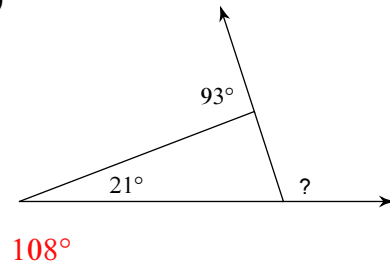

294)

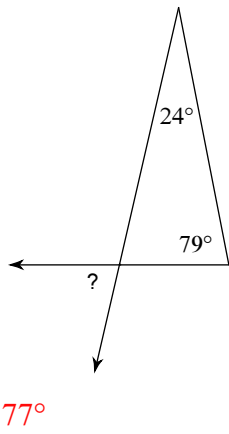

295)

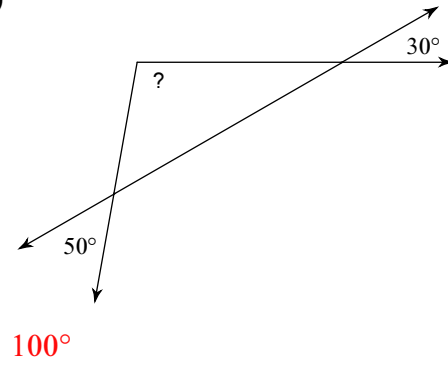

296)

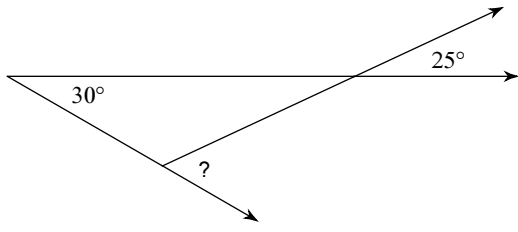

55°

297)

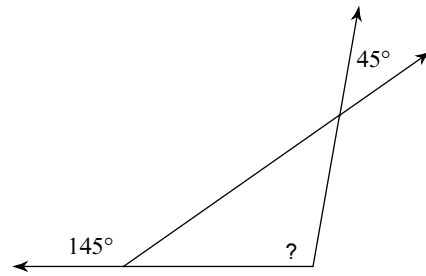

100°

298)

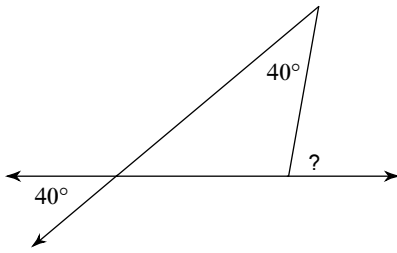

80°

299)

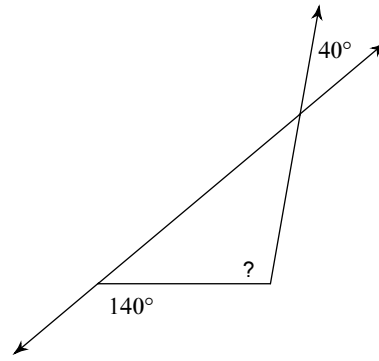

100°

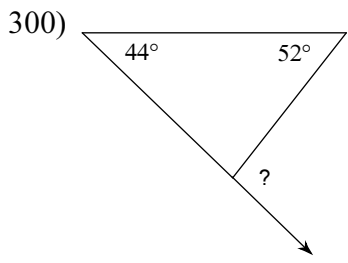

96°

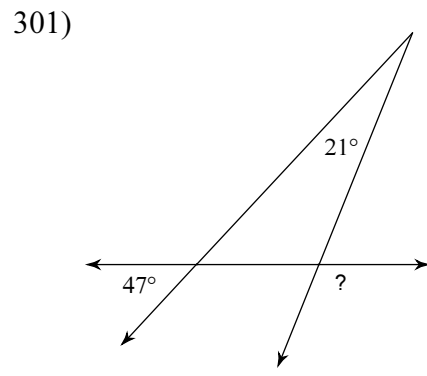

112°

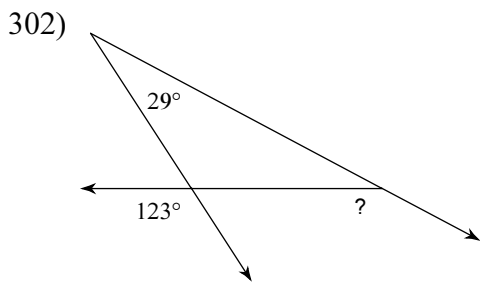

152°

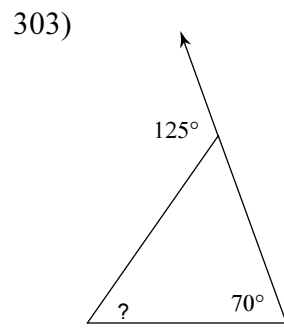

55°

304)

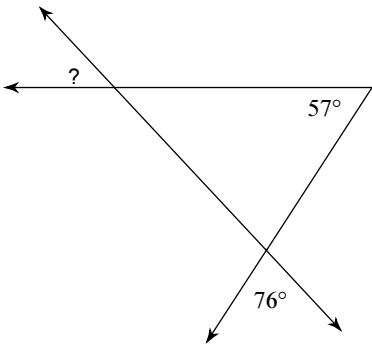

47°

305)

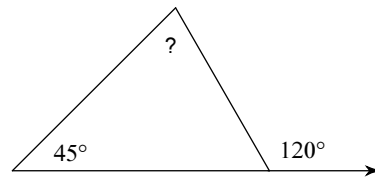

75°

306)

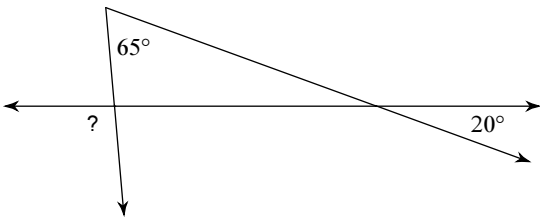

95°

307)

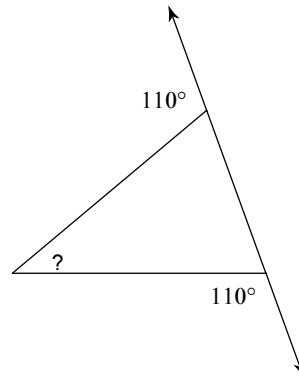

40°

308)

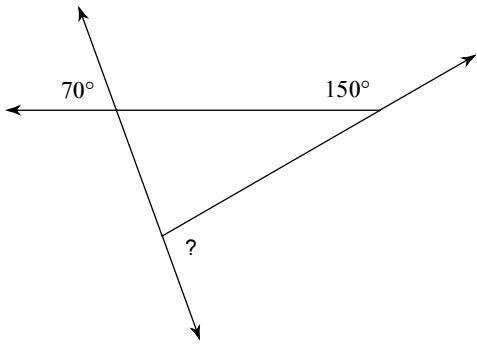

100°

309)

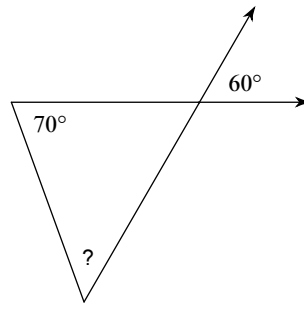

50°

310)

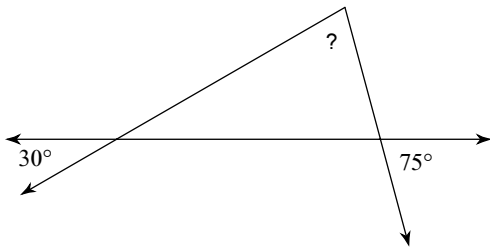

75°

311)

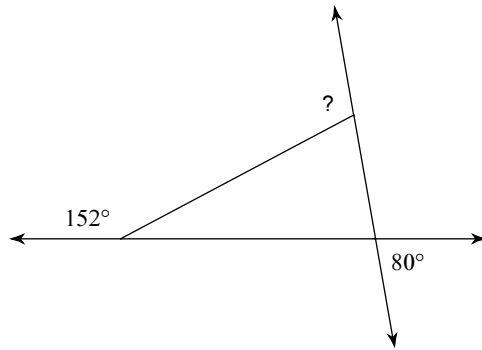

108°

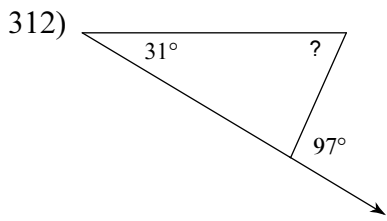

66°

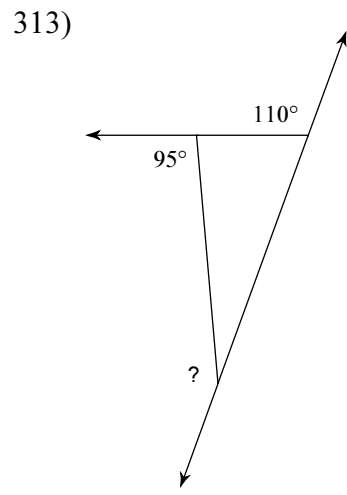

155°

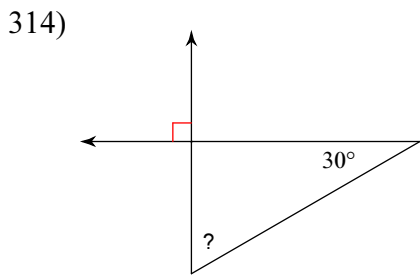

60°

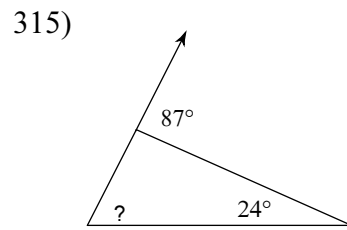

63°

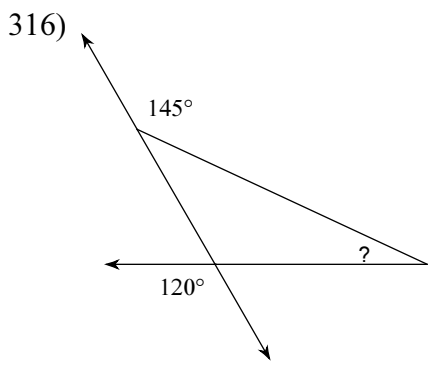

25°

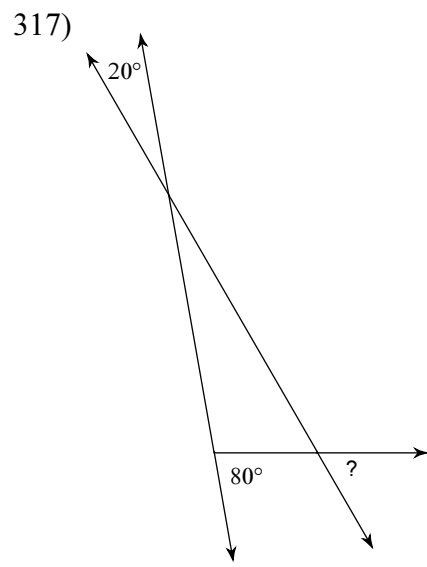

60°

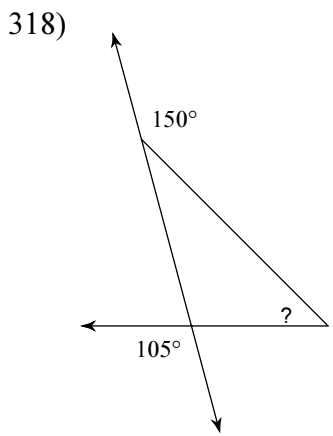

45°

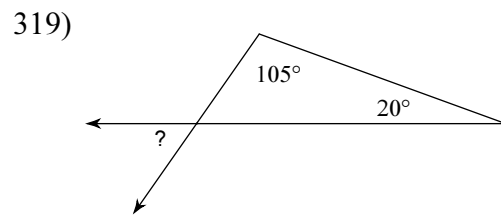

55°

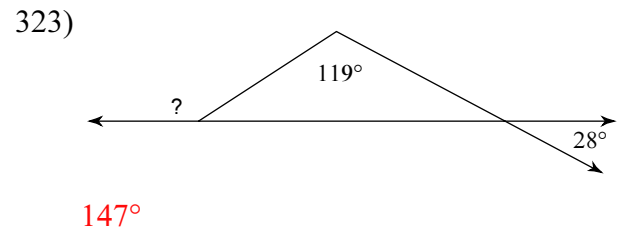
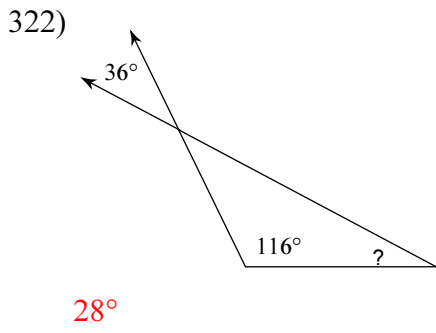
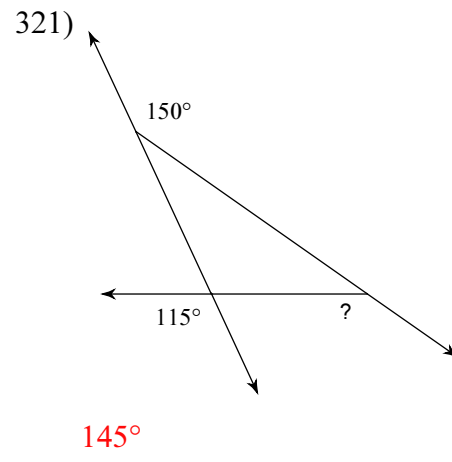
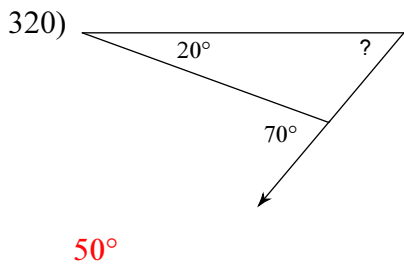

324)

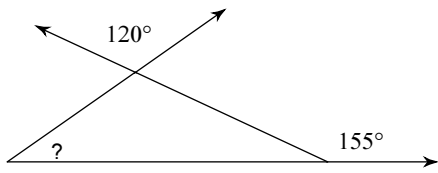

35°

325)

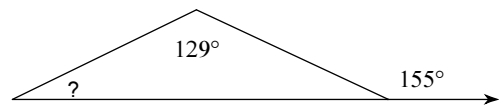

26°

326)

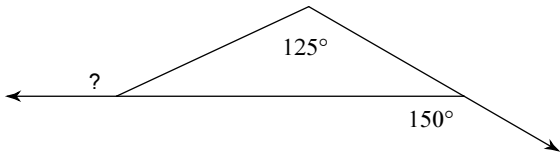

155°

327)

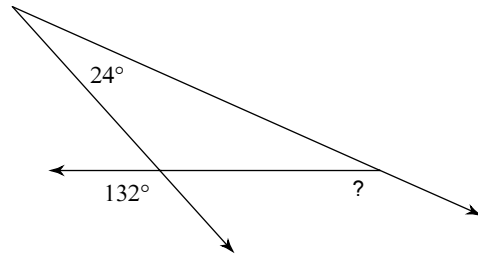

156°

328)

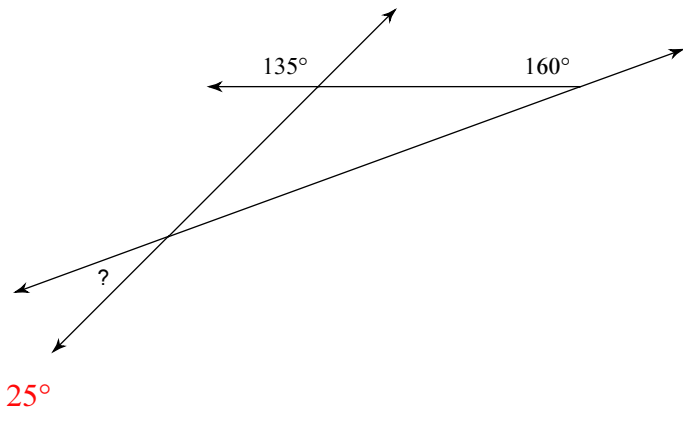

329)

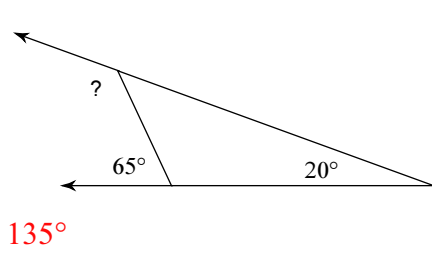

330)

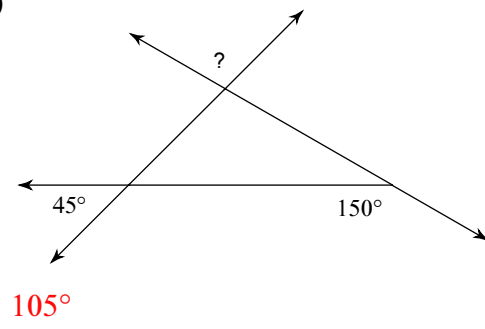

331)

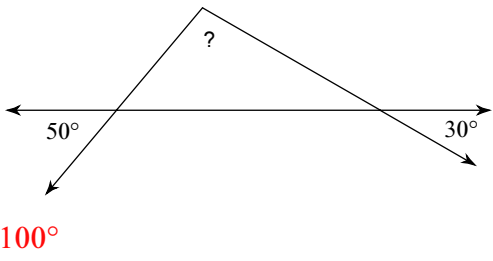

332)

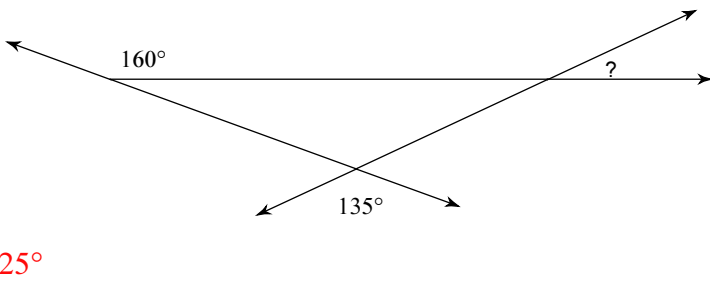

333)

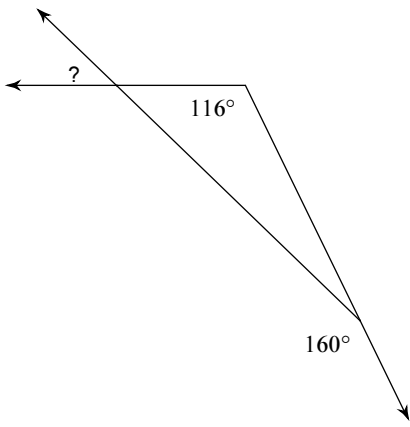

44°

334)

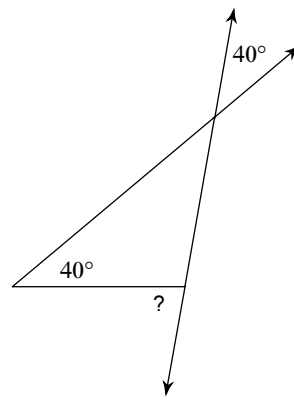

80°

335)

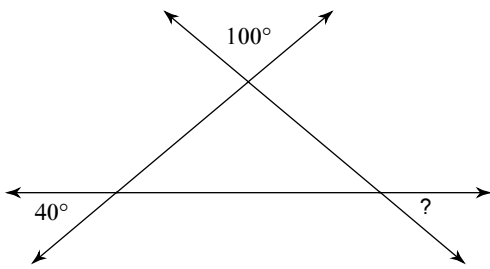

40°

336)

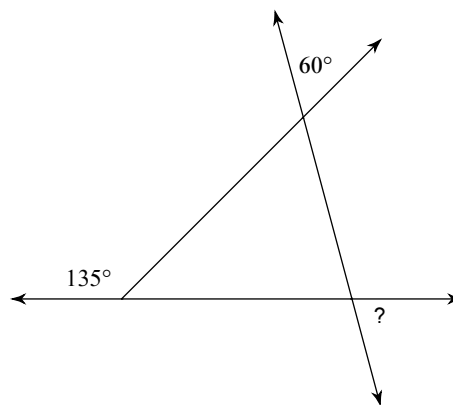

75°

337)

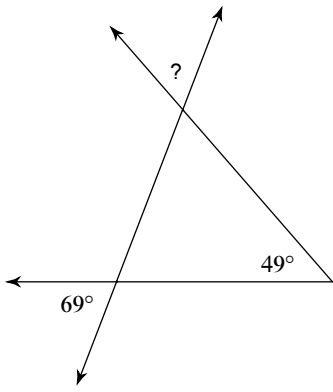

62°

338)

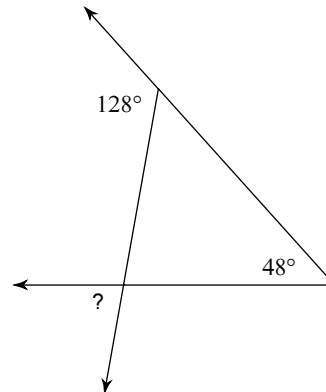

80°

339)

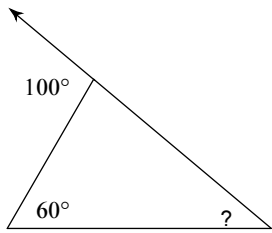

40°

340)

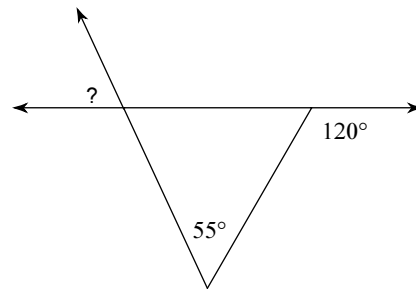

65°

341)

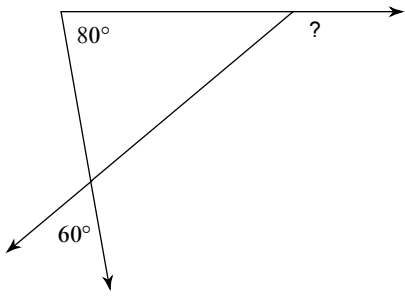

140°

342)

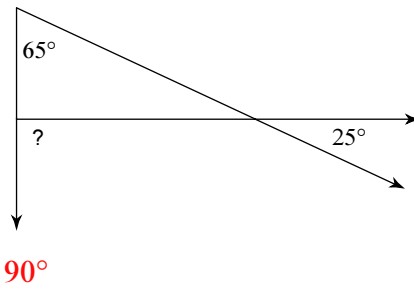

90°

343)

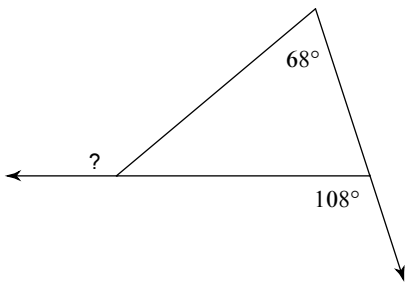

140°

344)

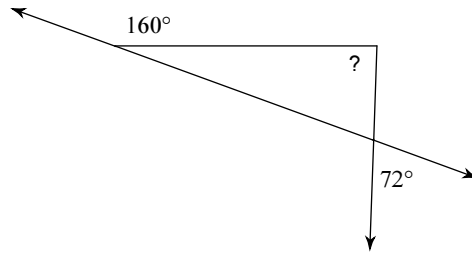

88°

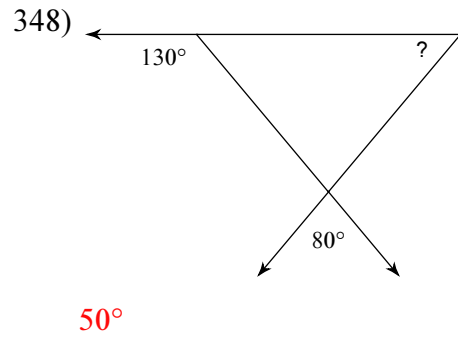
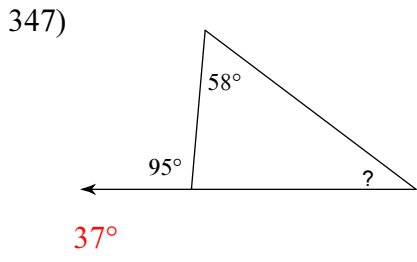
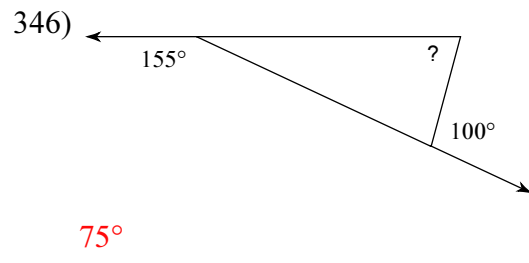
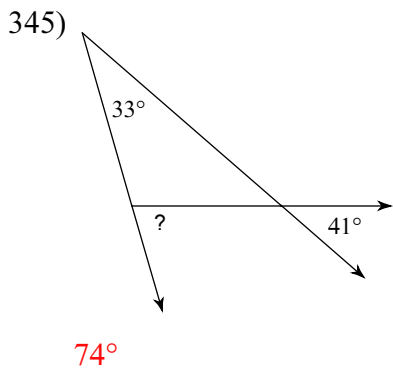

349)

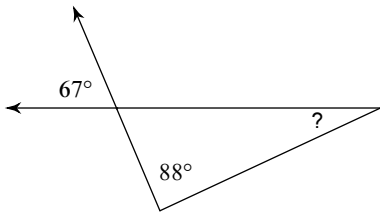

25°

350)

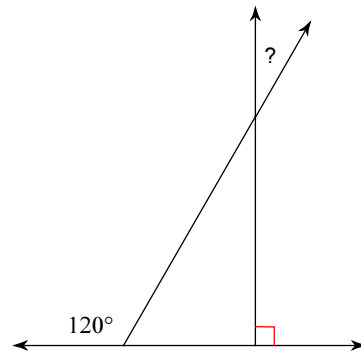

30°

351)

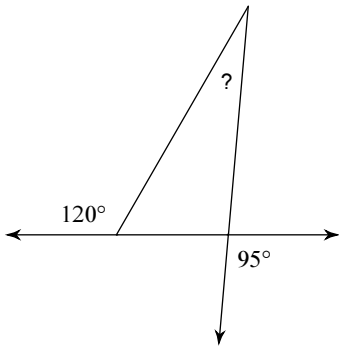

25°

352)

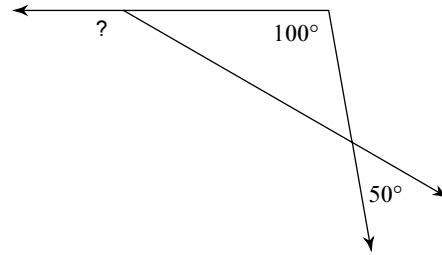

150°

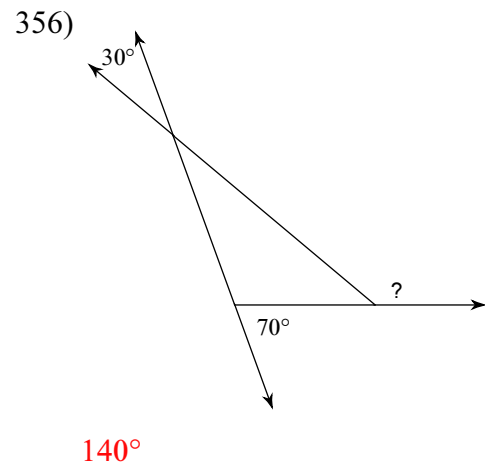
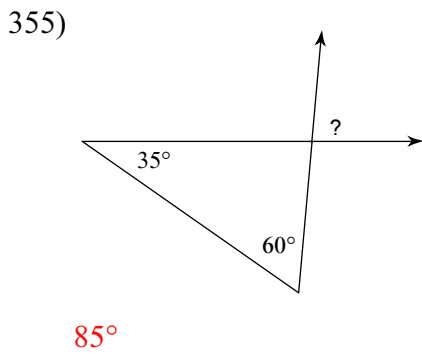
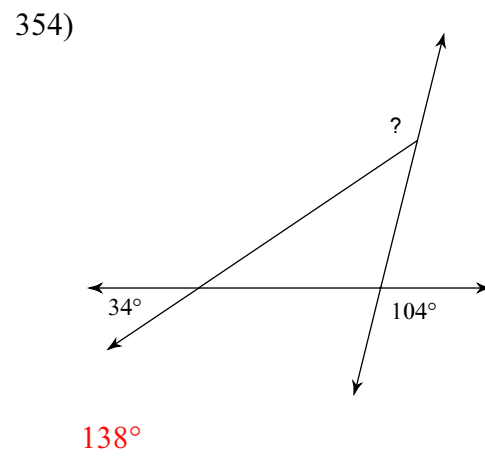
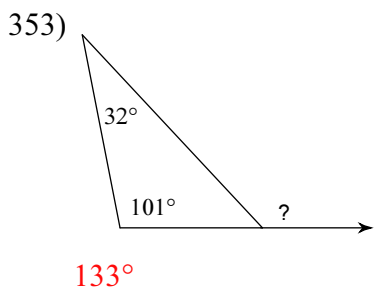

357)

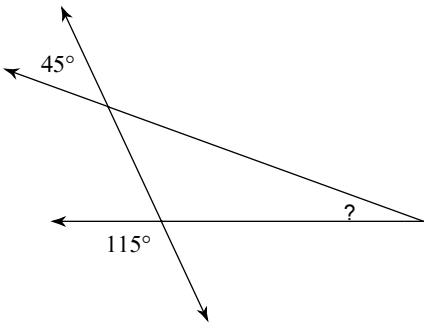

20°

358)

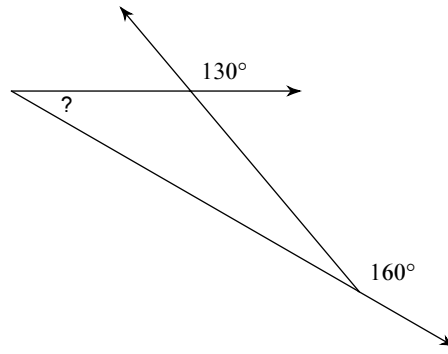

30°

359)

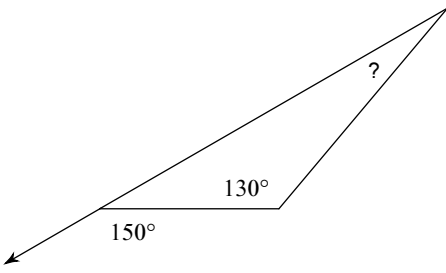

20°

360)

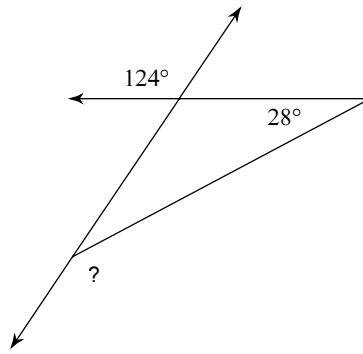

152°

361)

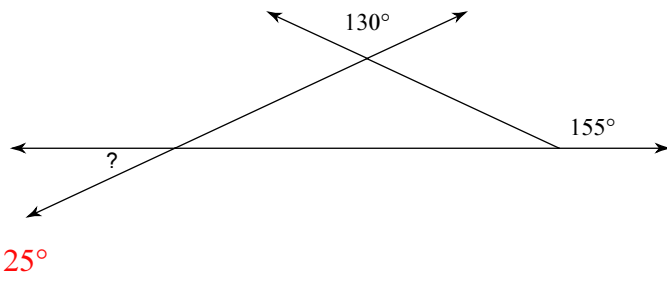

362)

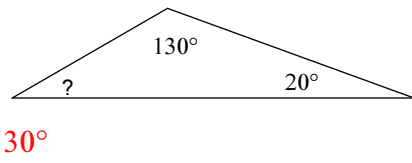

363)

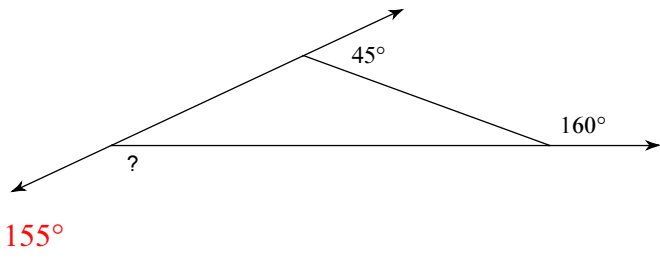

364)

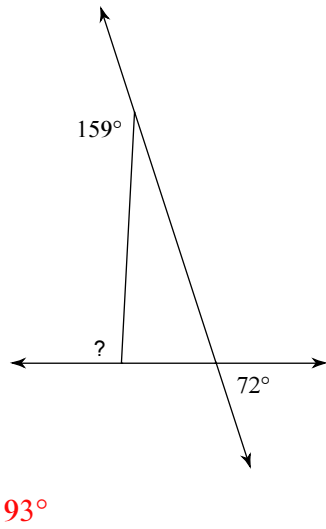

365)

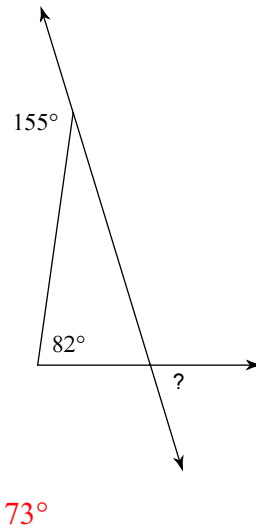

366)

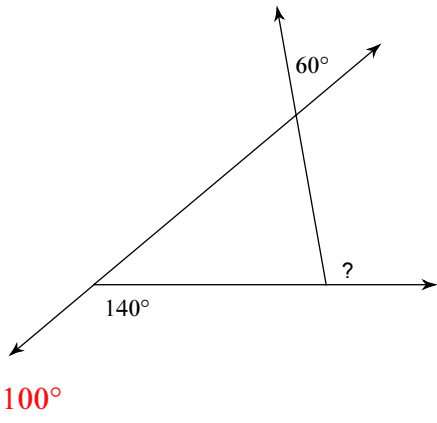

367)

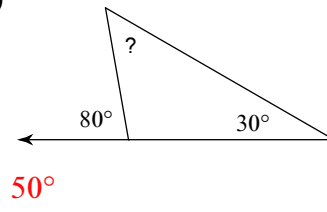

368)

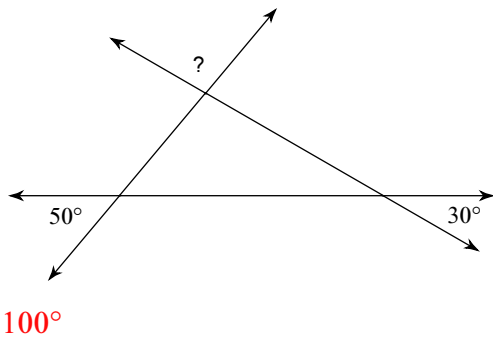

369)

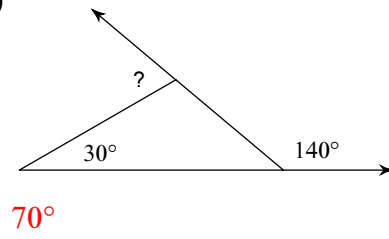

370)

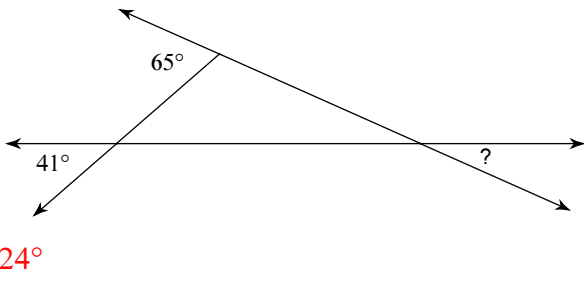

371)

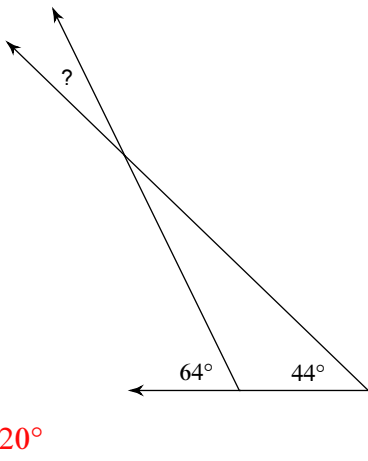

372)

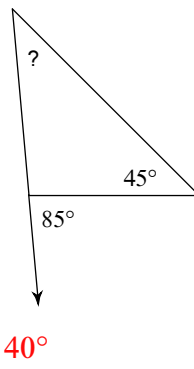

373)

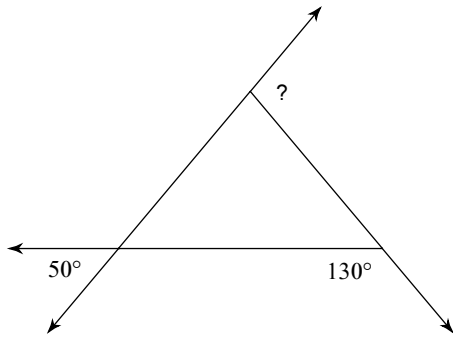

100°

374)

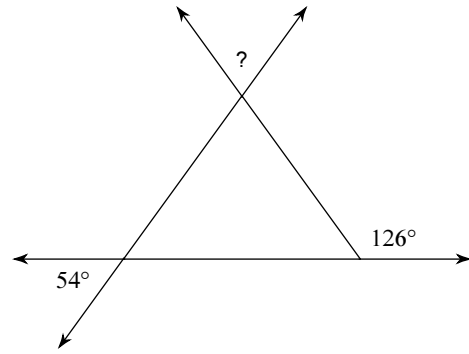

72°

375)

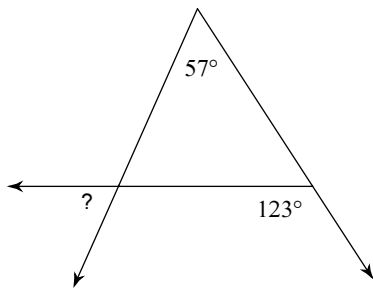

66°

376)

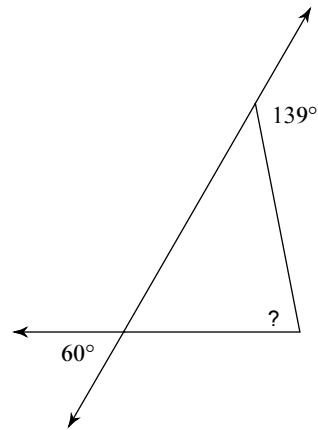

79°

377)

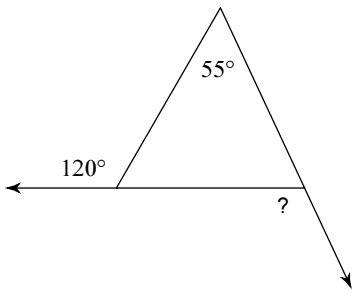

115°

378)

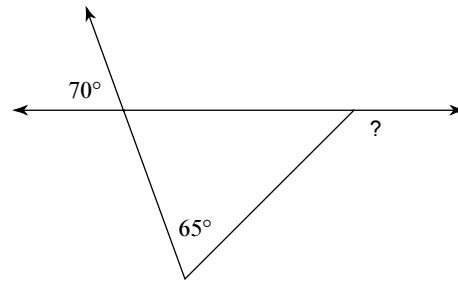

135°

379)

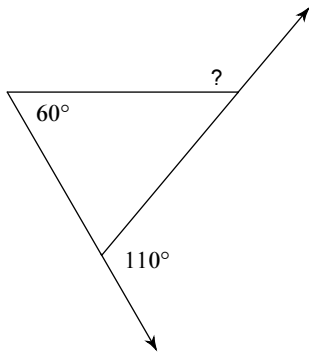

130°

380)

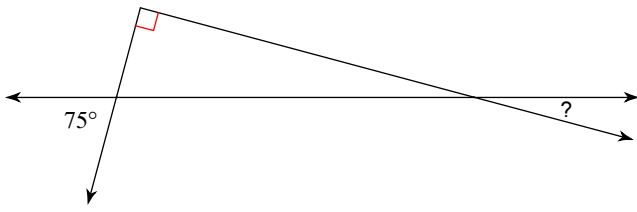

15°

381)

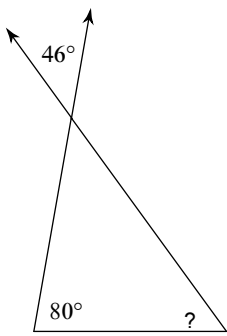

54°

382)

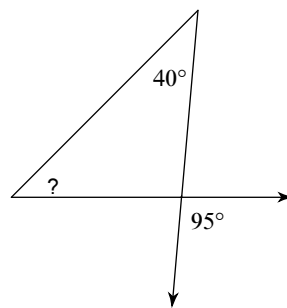

45°

383)

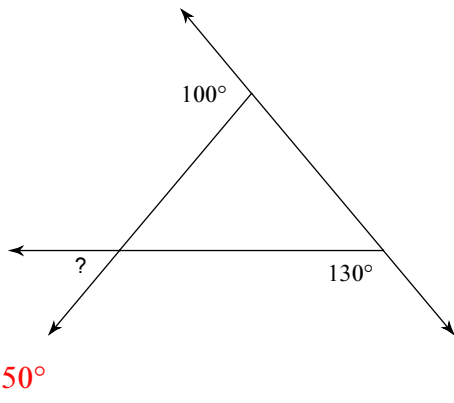

384)

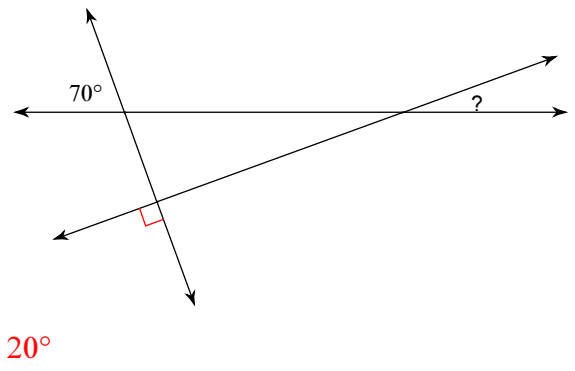

385)

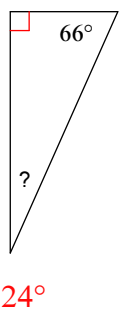

386)

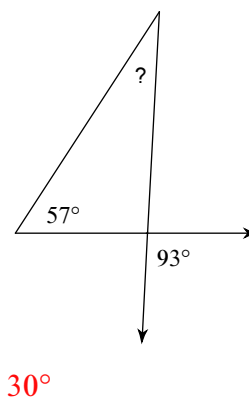

387)

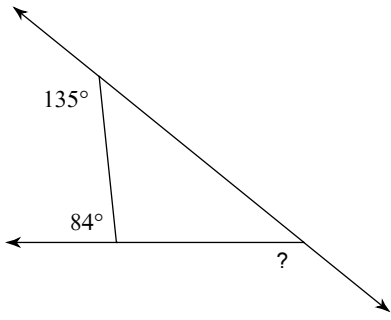

141°

388)

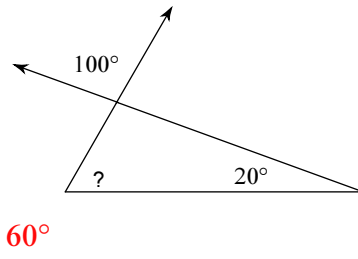

60°

389)

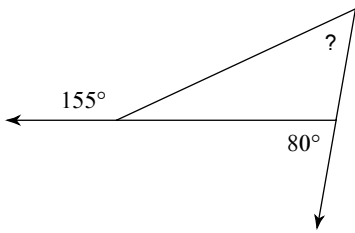

55°

390)

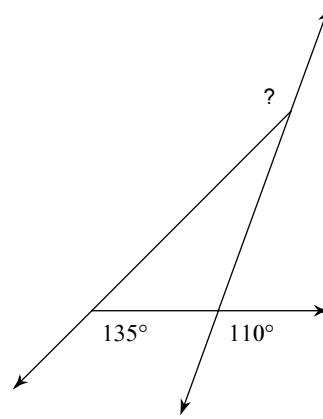

155°

391)

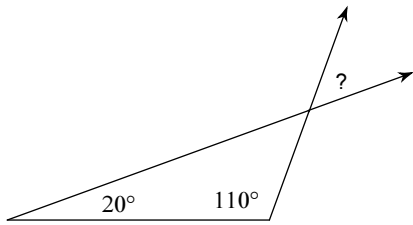

50°

392)

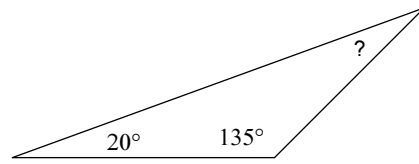

25°

393)

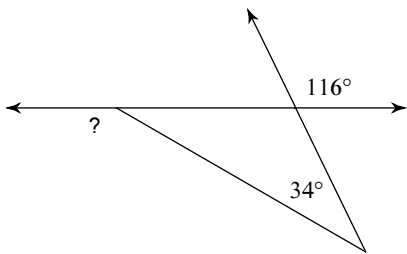

150°

394)

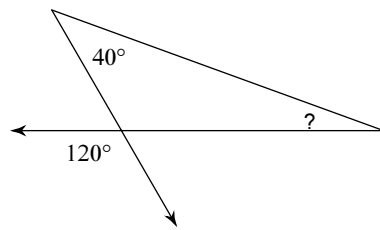

20°

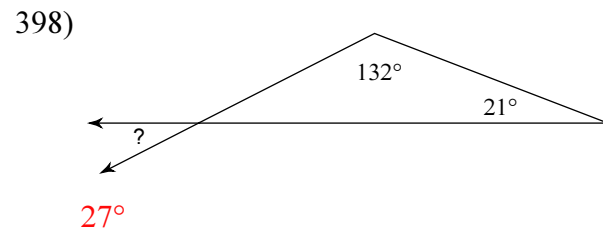
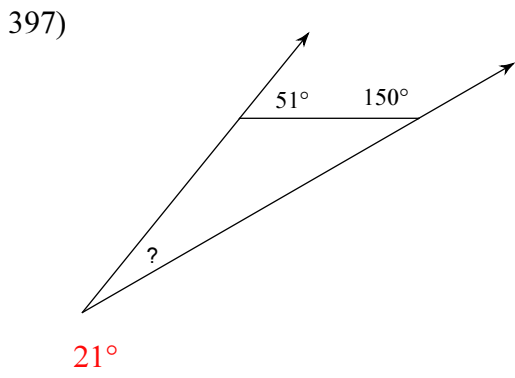
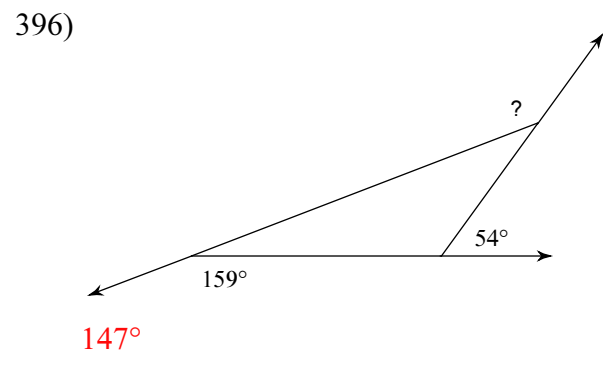
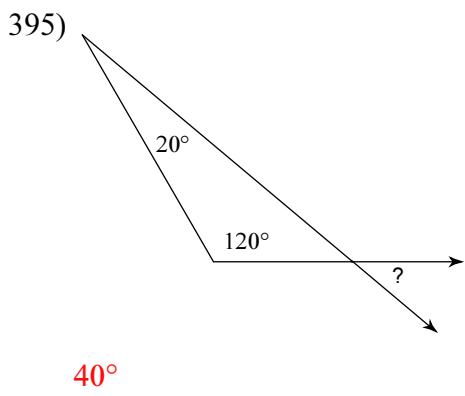

399)

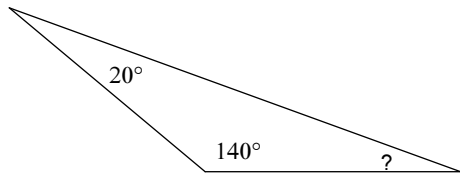

20°

400)

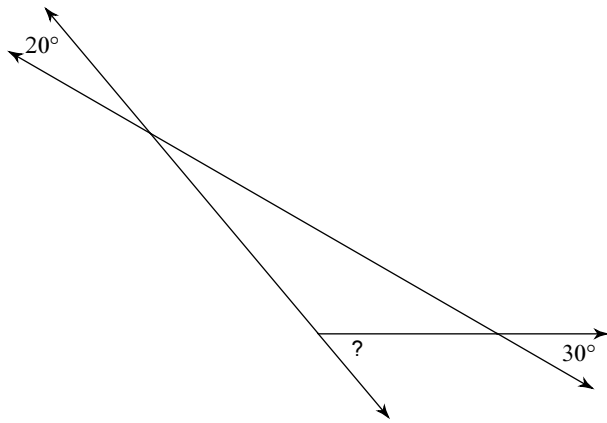

50°