

Volume of solid figures

Find the volume of triangular prisms and pyramids, square prism and pyramids, rectangular prism and pyramids:

1)

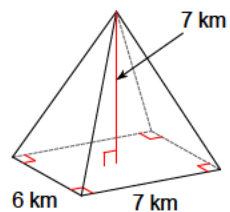

2)

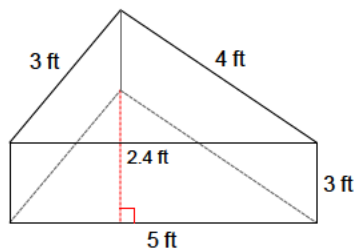

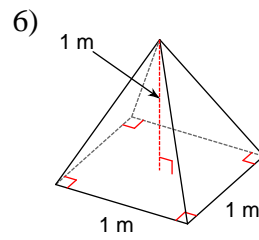
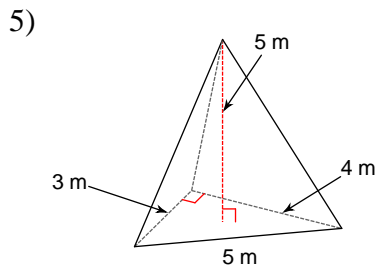
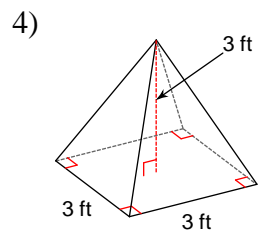
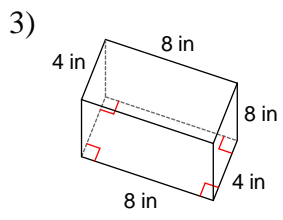

7)

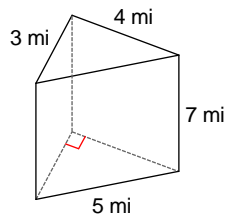

8)

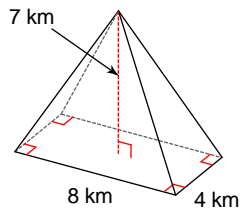

9)

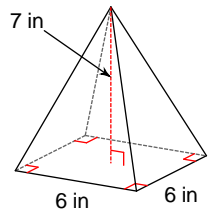

10)

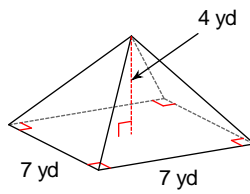

11)

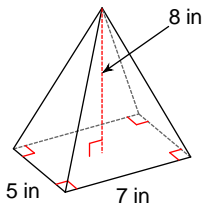

12)

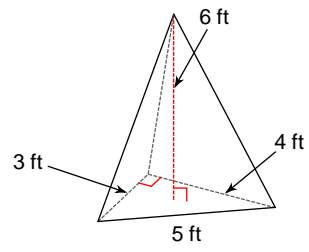

13)

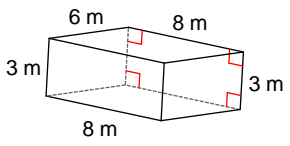

14)

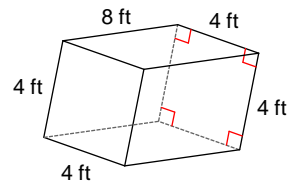

15)

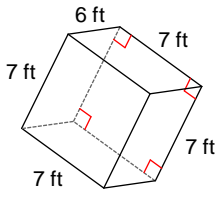

16)

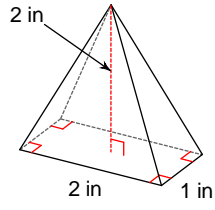

17)

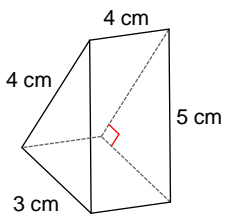

18)

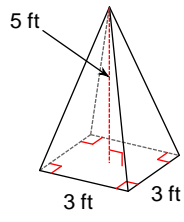

19)

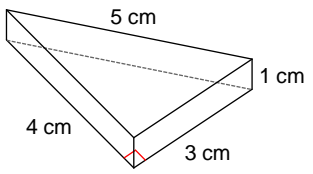

20)

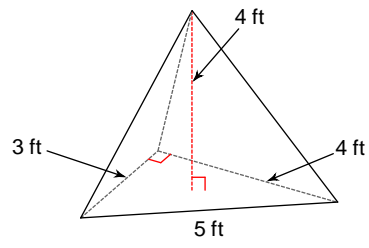

21)

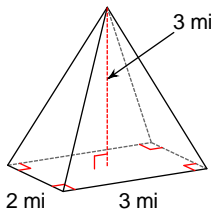

22)

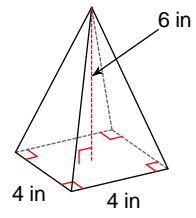

23)

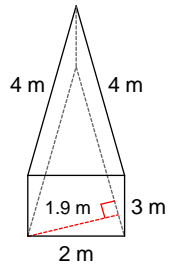

24)

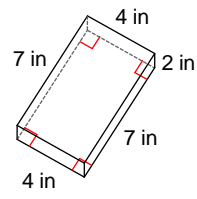

25)

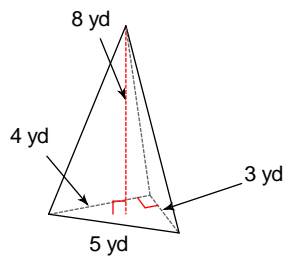

26)

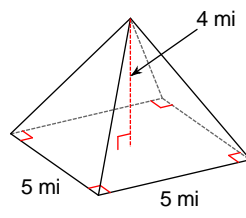

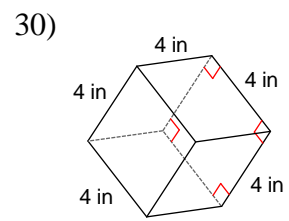
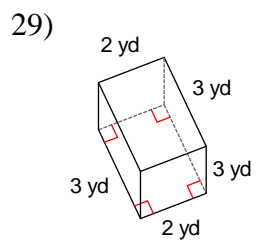
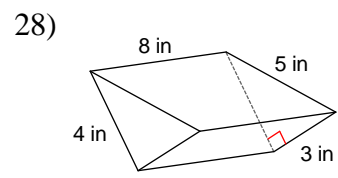
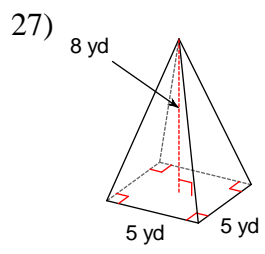

31)

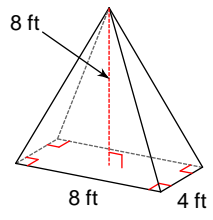

32)

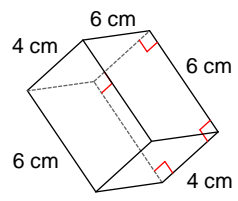

33)

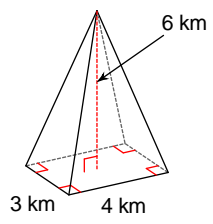

34)

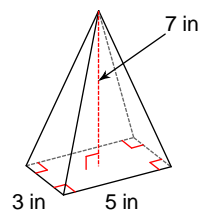

35)

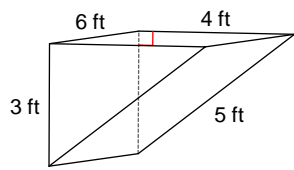

36)

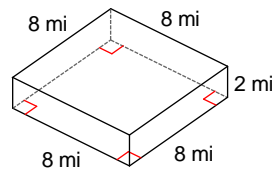

37)

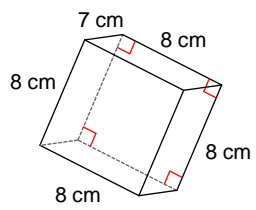

38)

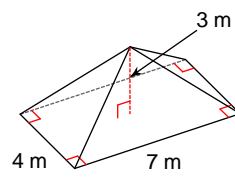

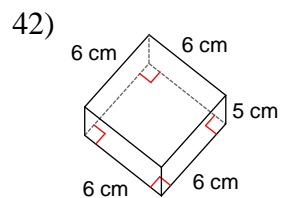
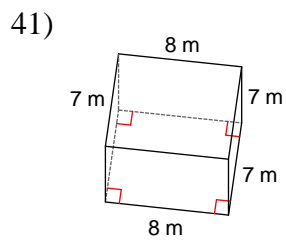
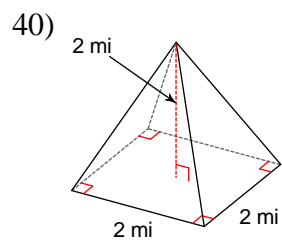
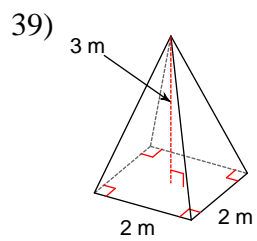

43)

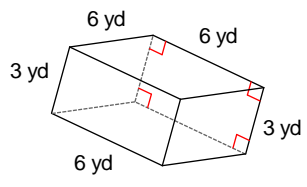

44)

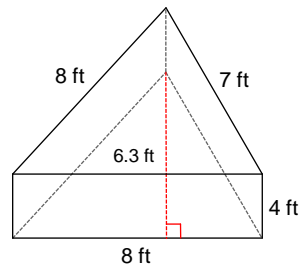

45)

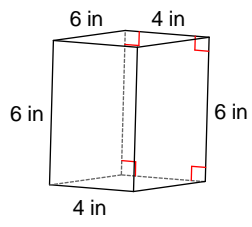

46)

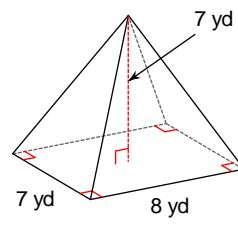

47)

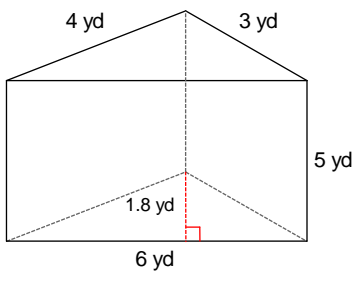

48)

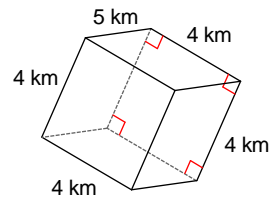

49)

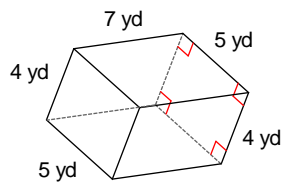

50)

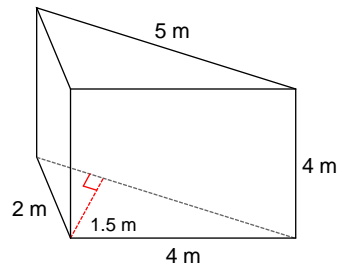

51)

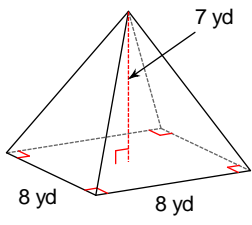

52)

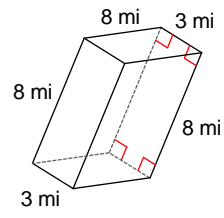

53)

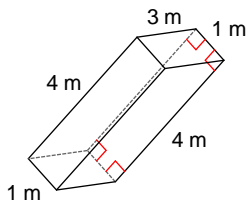

54)

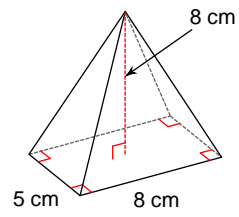

55)

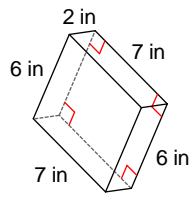

56)

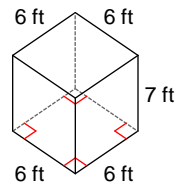

57)

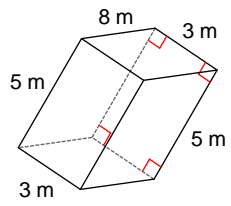

58)

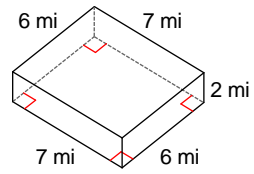

59)

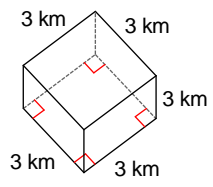

60)

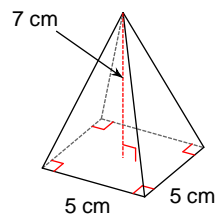

61)

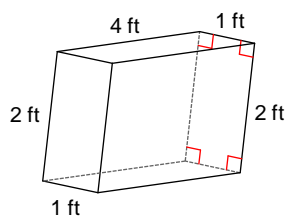

62)

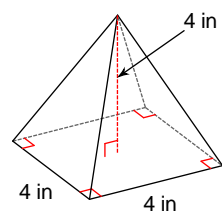

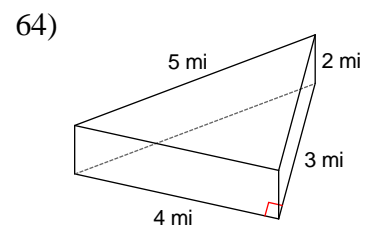
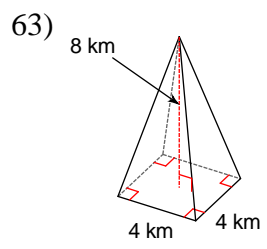

65)

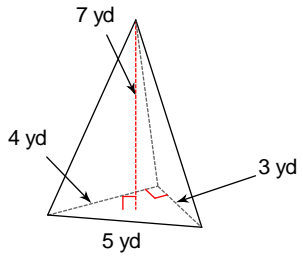

66)

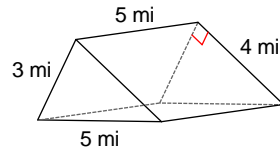

67)

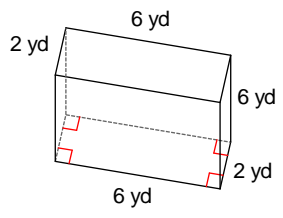

68)

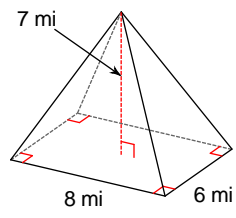

69)

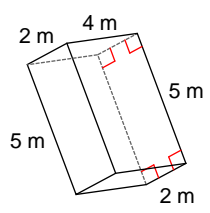

70)

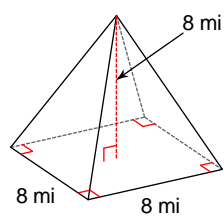

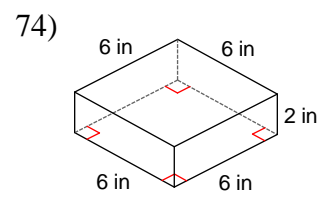
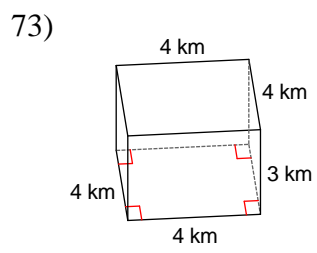
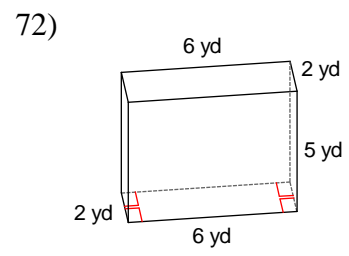
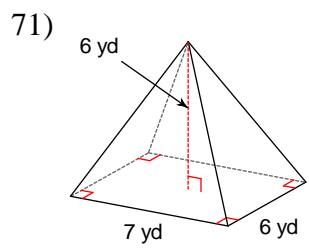

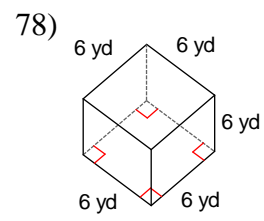
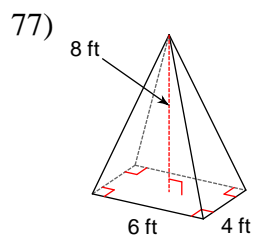
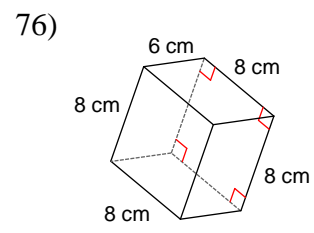
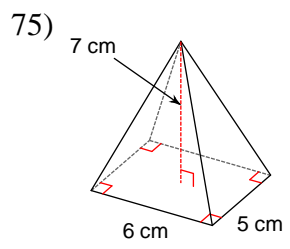

79)

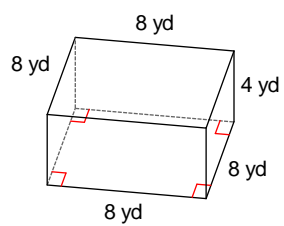

80)

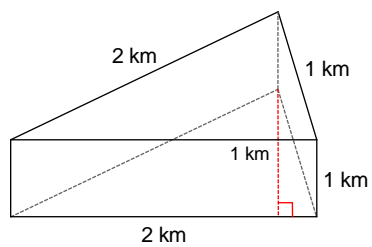

81)

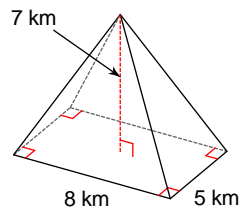

82)

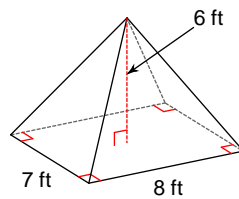

83)

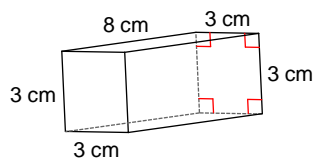

84)

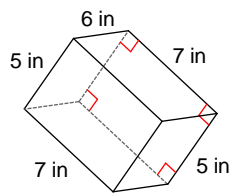

85)

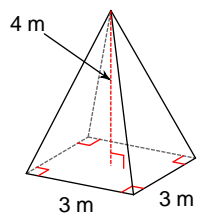

86)

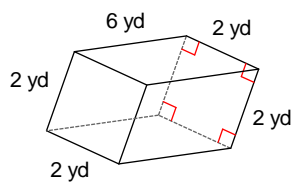

87)

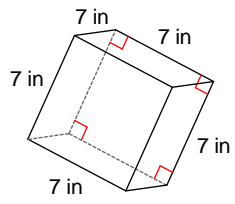

88)

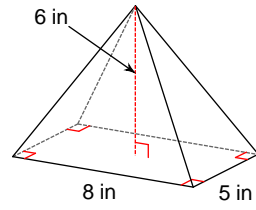

89)

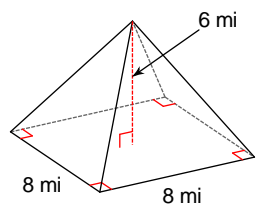

90)

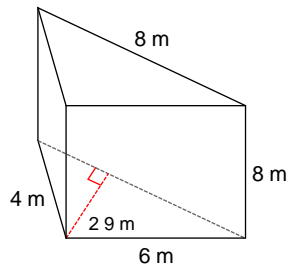

91)

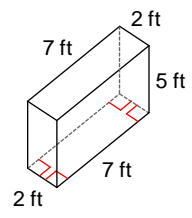

92)

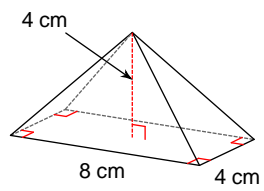

93)

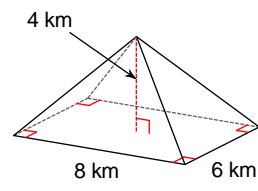

94)

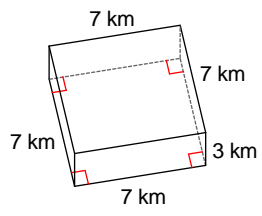

95)

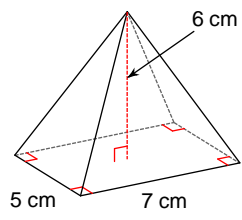

96)

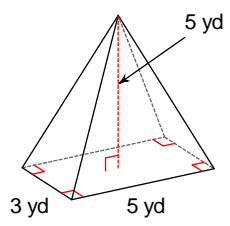

97)

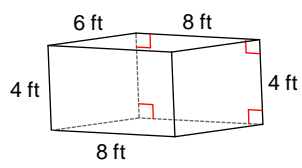

98)

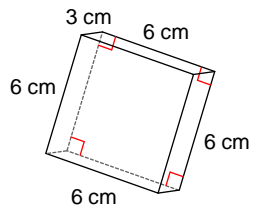

99)

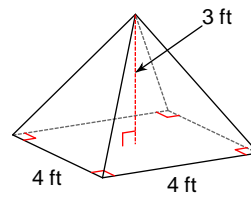

100)

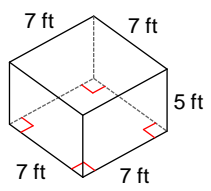

Find the volume of trapezoidal prisms, pentagonal prisms and pyramids, hexagonal prisms and pyramids:

101)

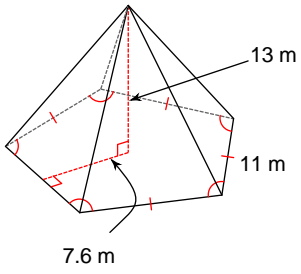

102)

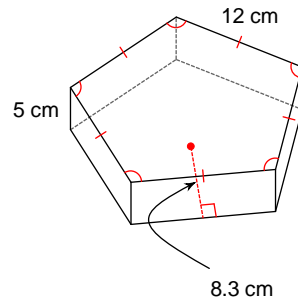

103)

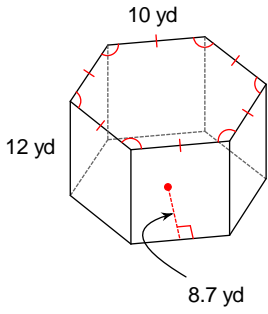

104)

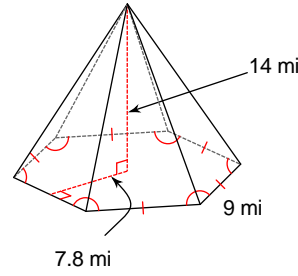

105)

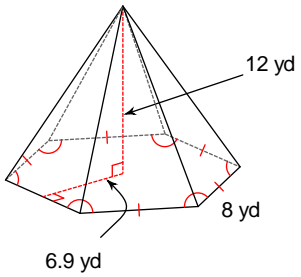

106)

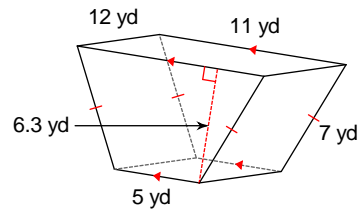

107)

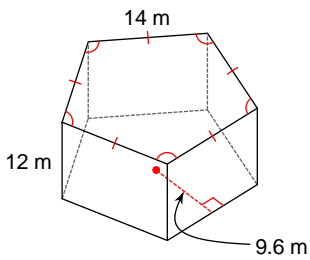

108)

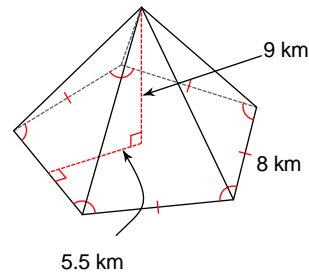

109)

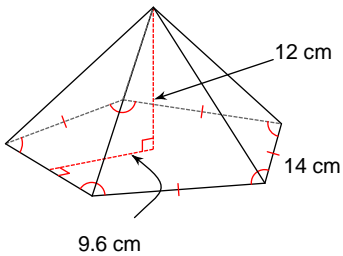

110)

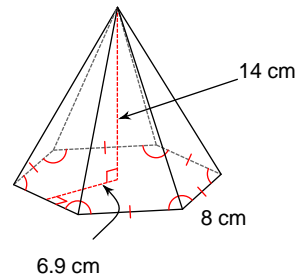

111)

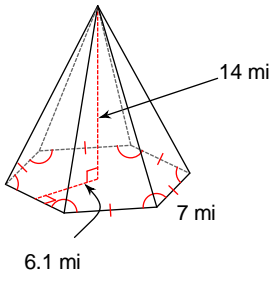

112)

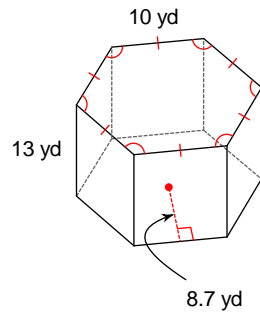

113)

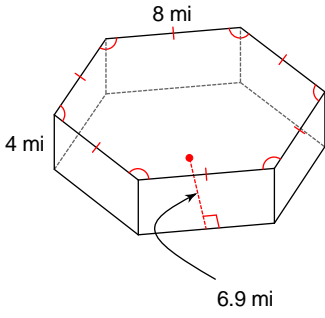

114)

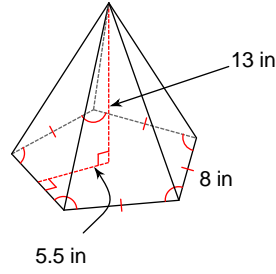

115)

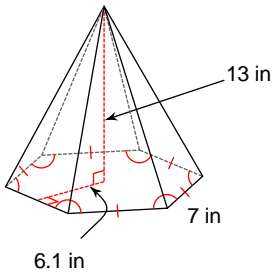

116)

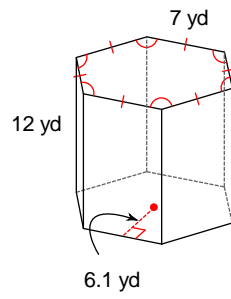

117)

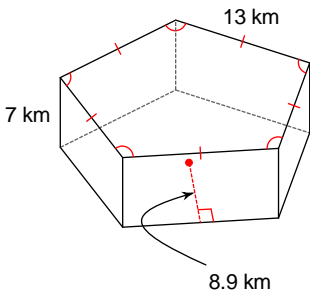

118)

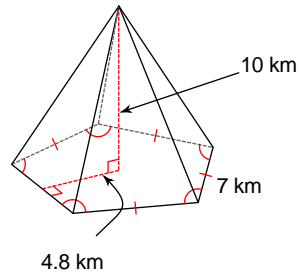

119)

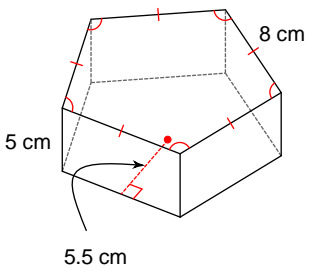

120)

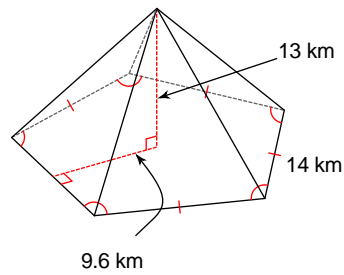

121)

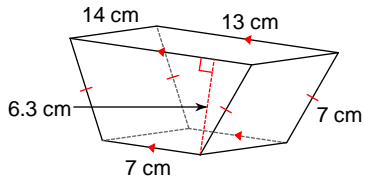

122)

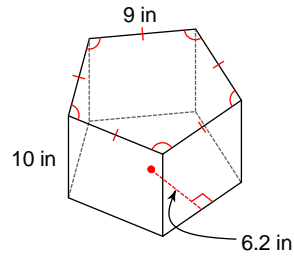

123)

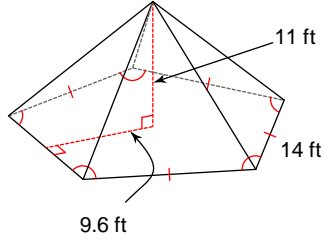

124)

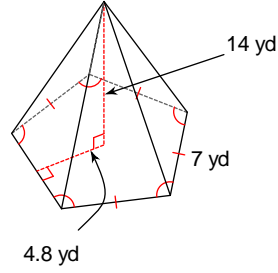

125)

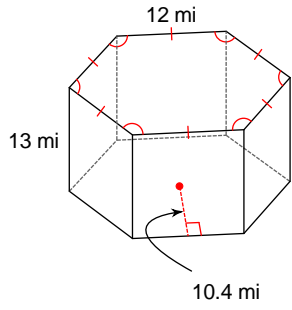

126)

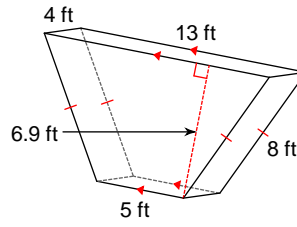

127)

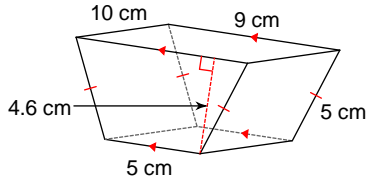

128)

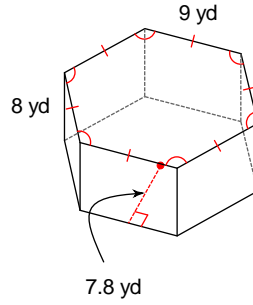

129)

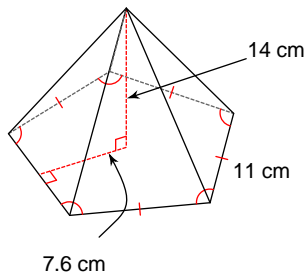

130)

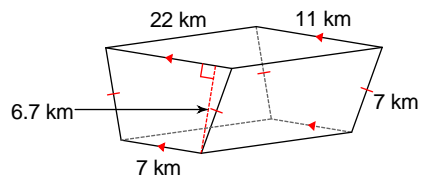

131)

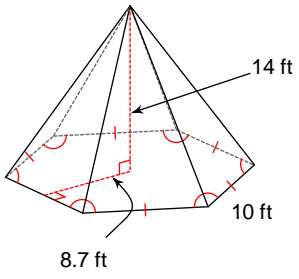

132)

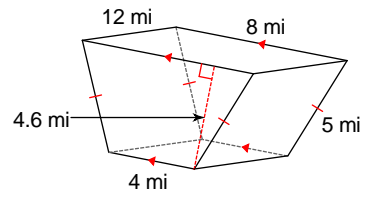

133)

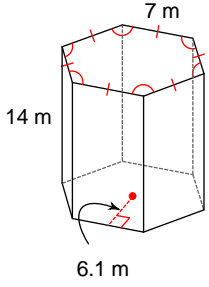

134)

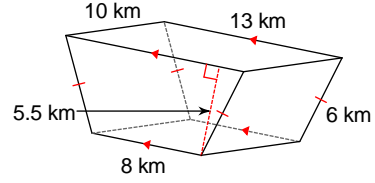

135)

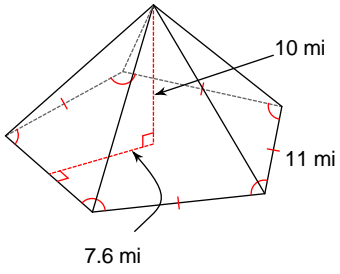

136)

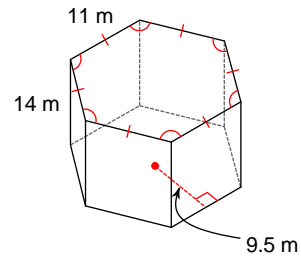

137)

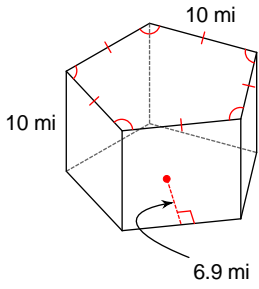

138)

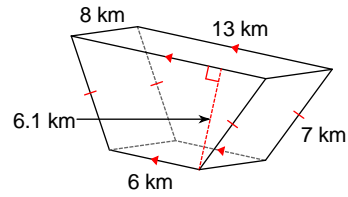

139)

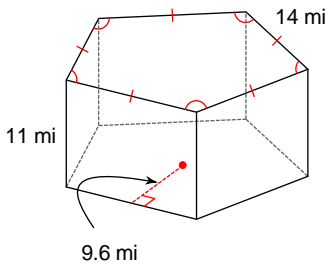

140)

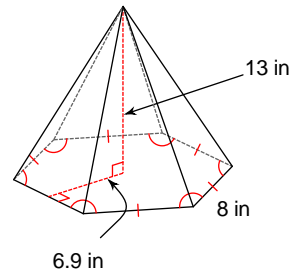

141)

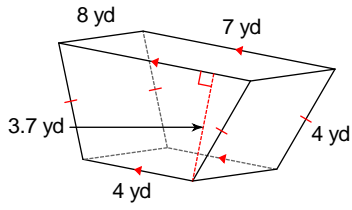

142)

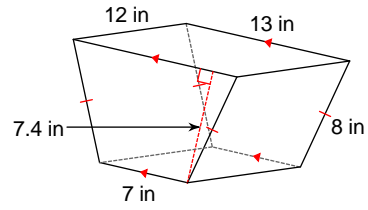

143)

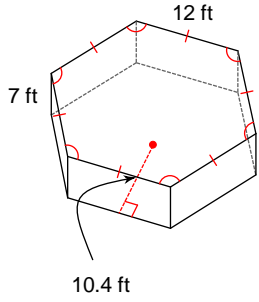

144)

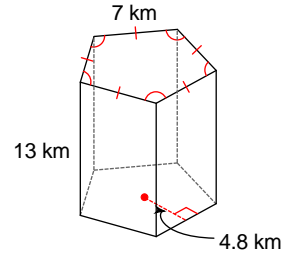

145)

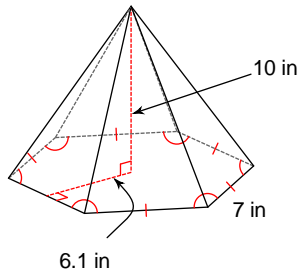

146)

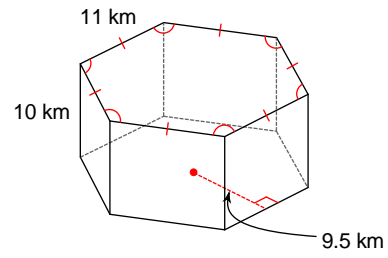

147)

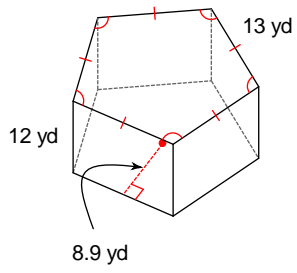

148)

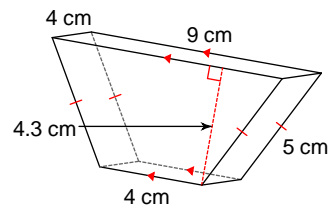

149)

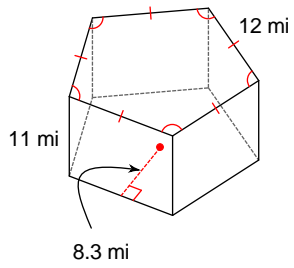

150)

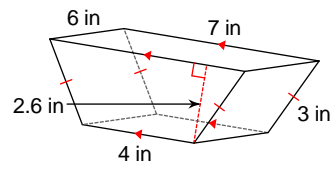

151)

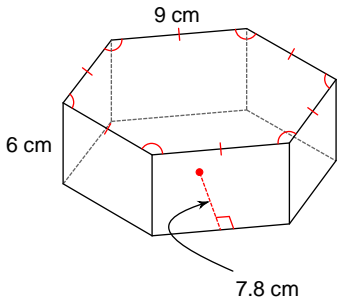

152)

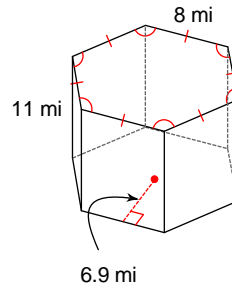

153)

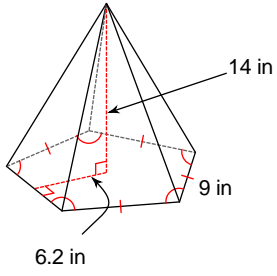

154)

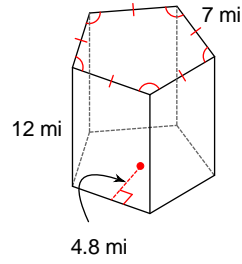

155)

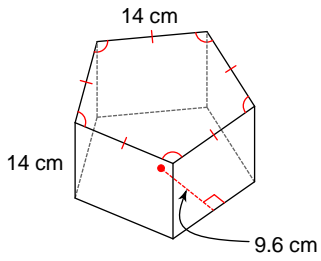

156)

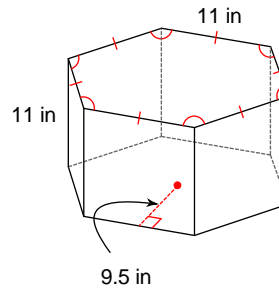

157)

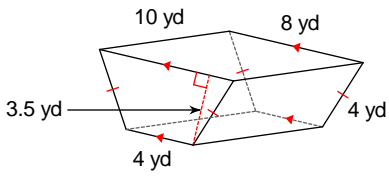

158)

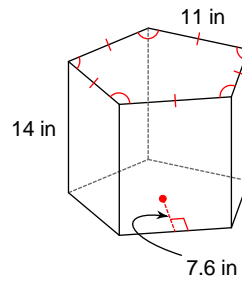

159)

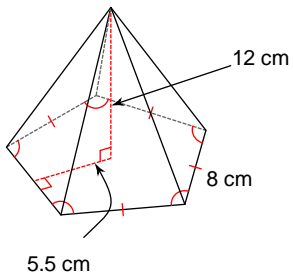

160)

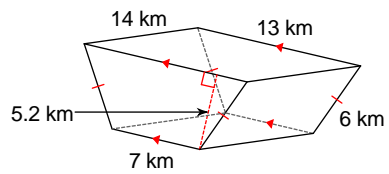

161)

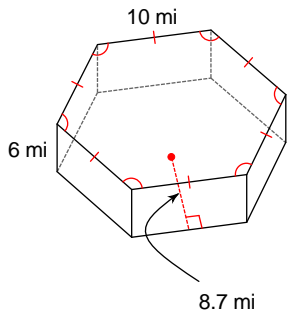

162)

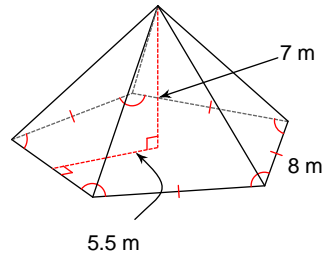

163)

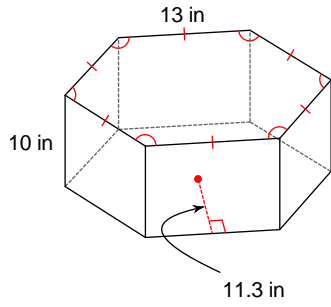

164)

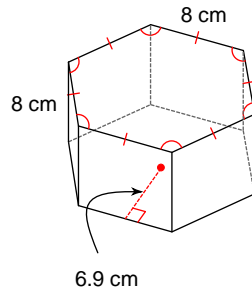

165)

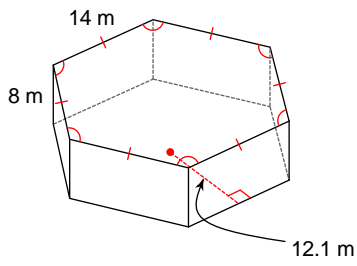

166)

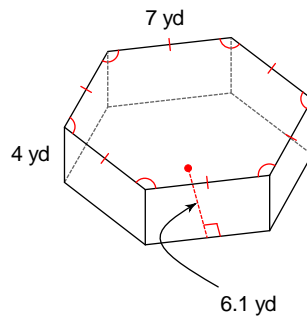

167)

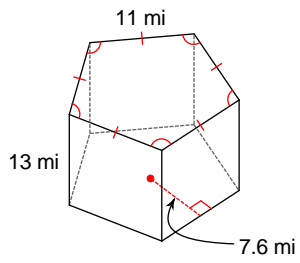

168)

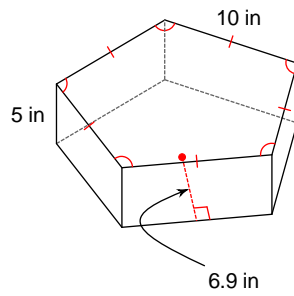

169)

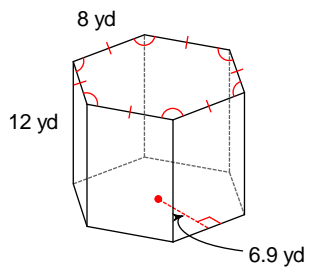

170)

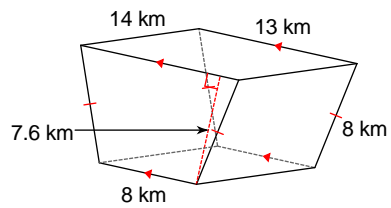

171)

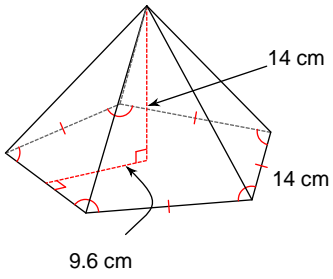

172)

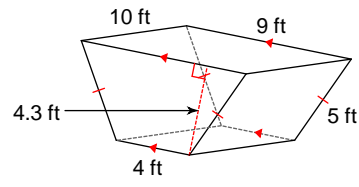

173)

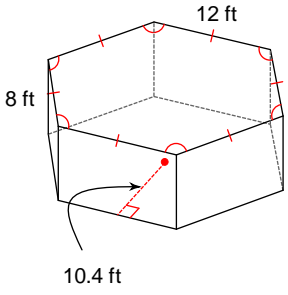

174)

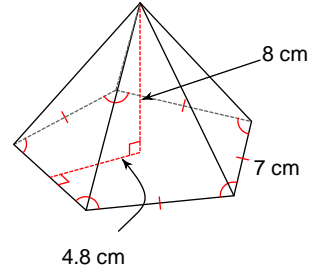

175)

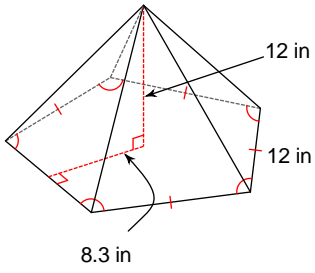

176)

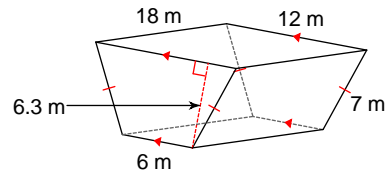

177)

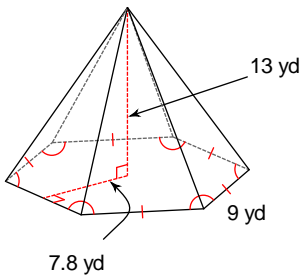

178)

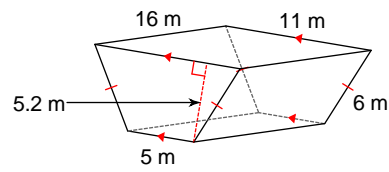

179)

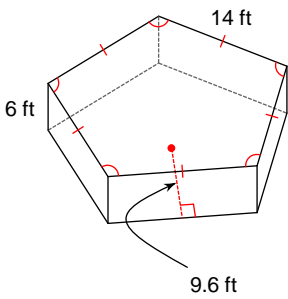

180)

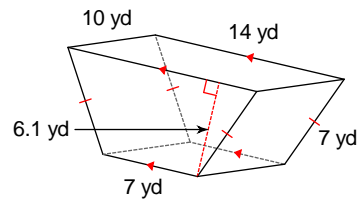

181)

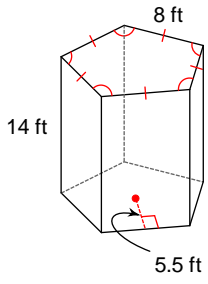

182)

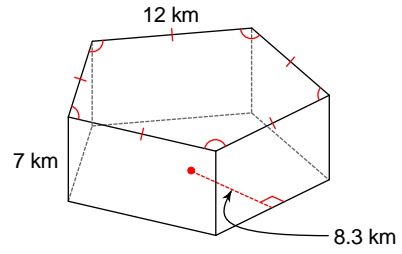

183)

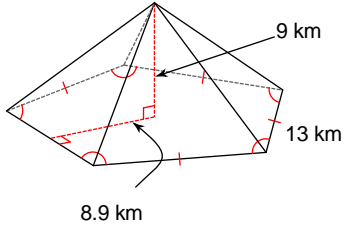

184)

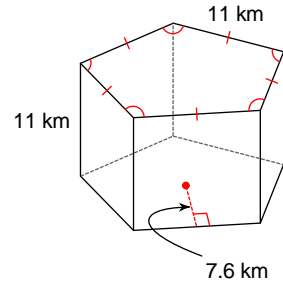

185)

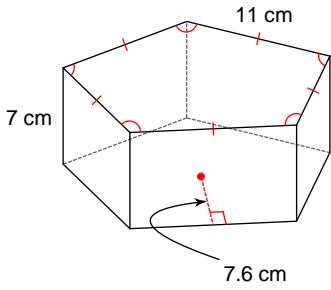

186)

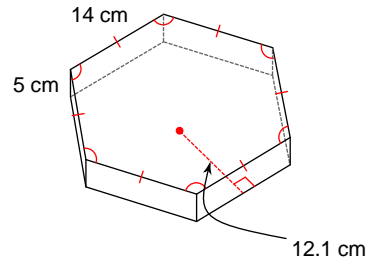

187)

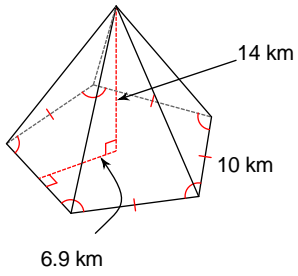

188)

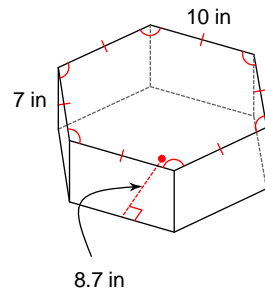

189)

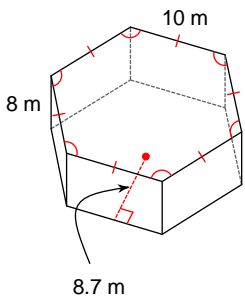

190)

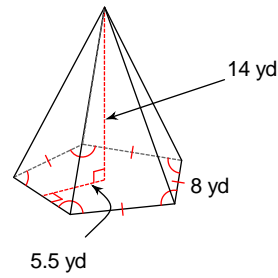

191)

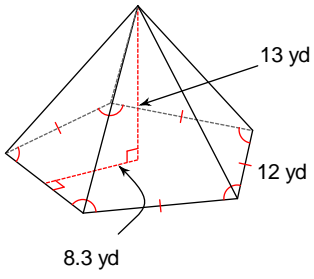

192)

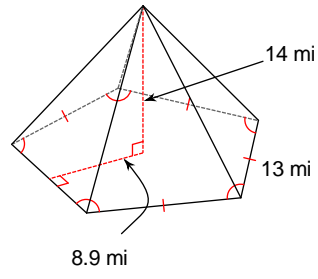

193)

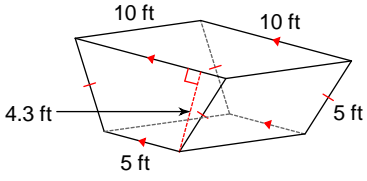

194)

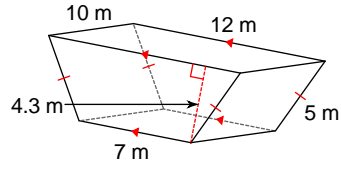

195)

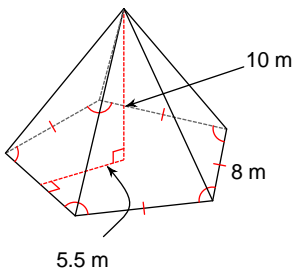

196)

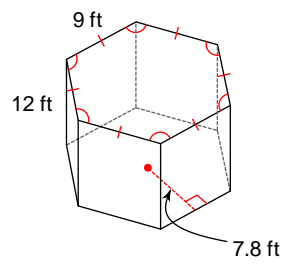

197)

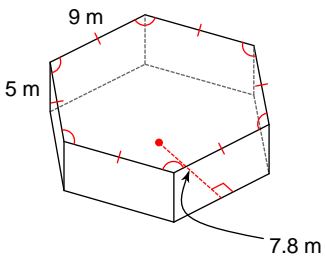

198)

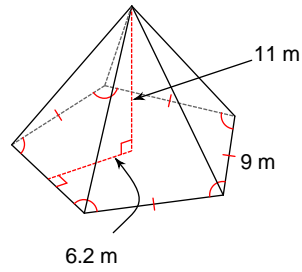

199)

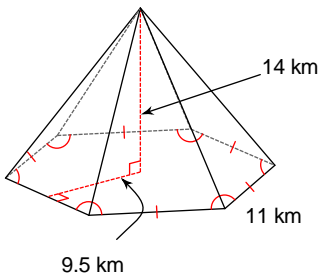

200)

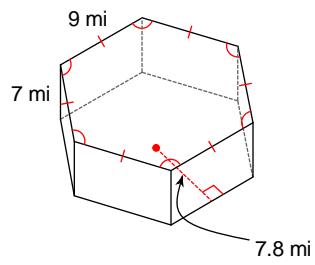

Find the volume of cylinders, cones and spheres:

201)

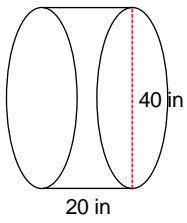

202)

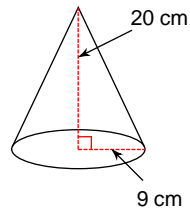

203)

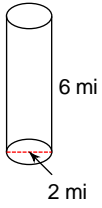

204)

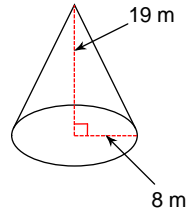

205)

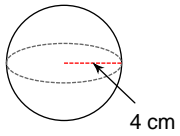

206)

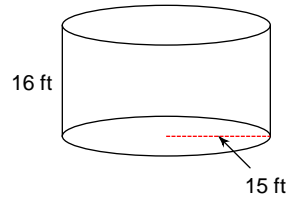

207)

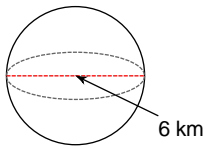

208)

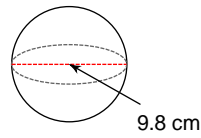

209)

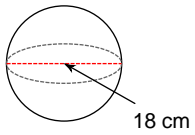

210)

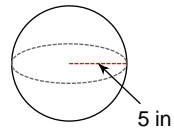

211)

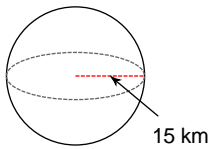

212)

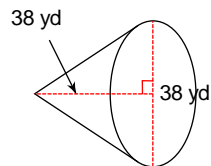

213)

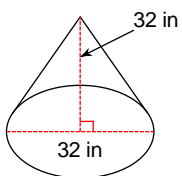

214)

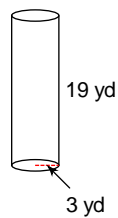

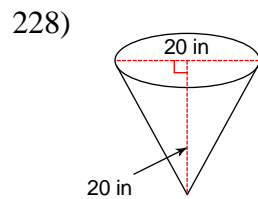
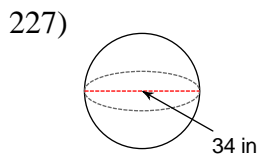
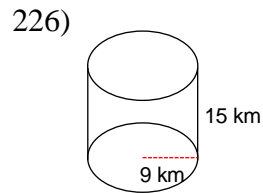
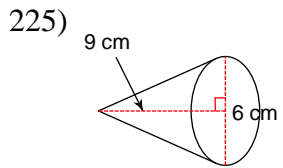
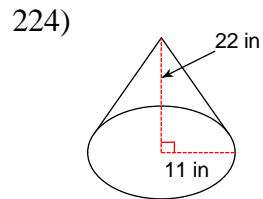
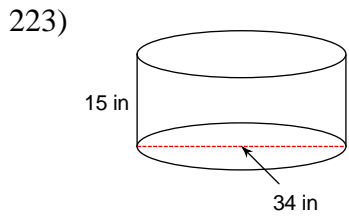
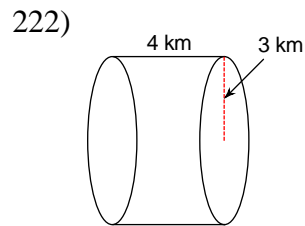
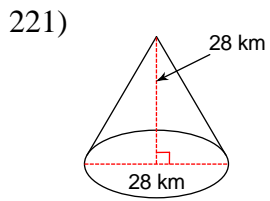
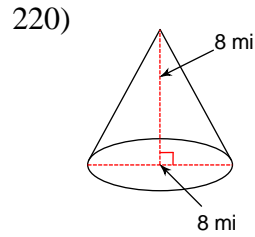
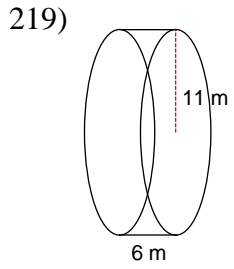
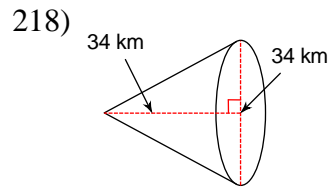
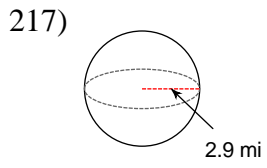
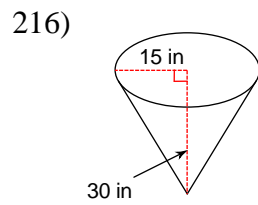
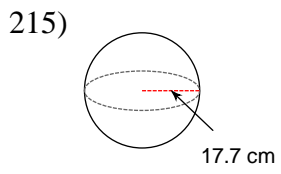

229)

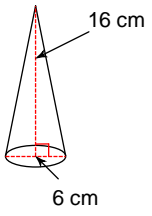

230)

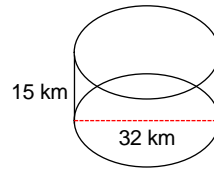

231)

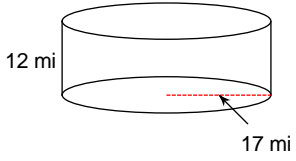

232)

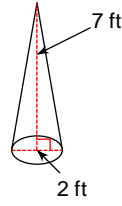

233)

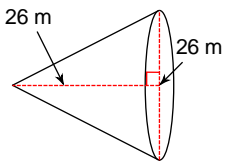

234)

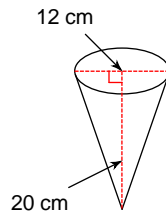

235)

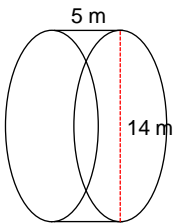

236)

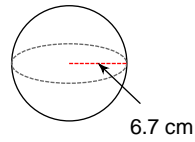

237)

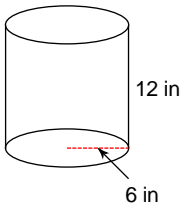

238)

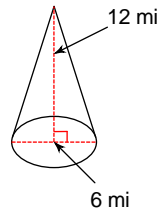

239)

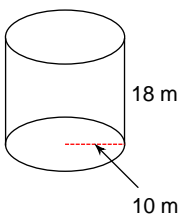

240)

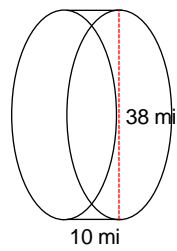

241)

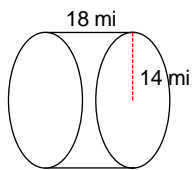

242)

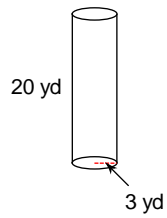

243)

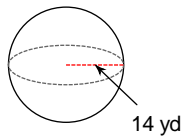

244)

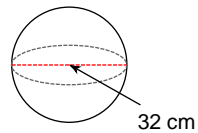

245)

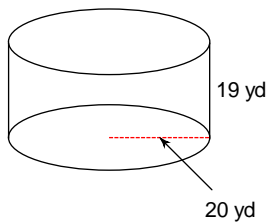

246)

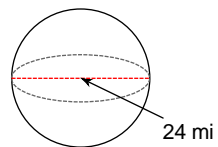

247)

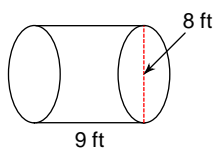

248)

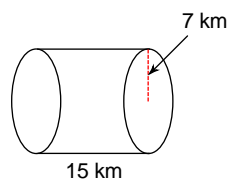

249)

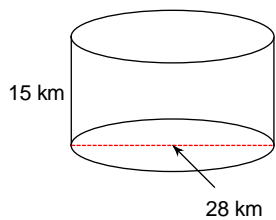

250)

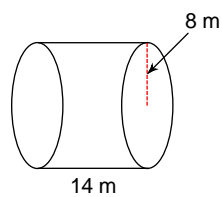

251)

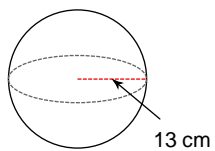

252)

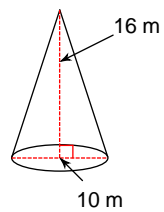

253)

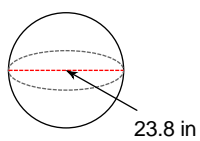

254)

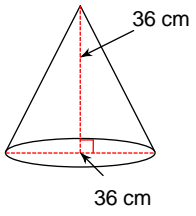

255)

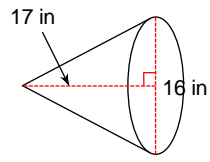

256)

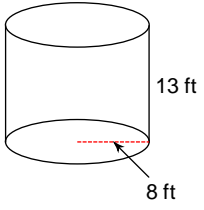

257)

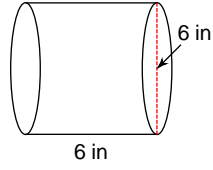

258)

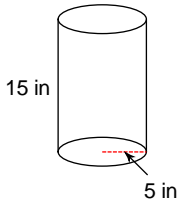

259)

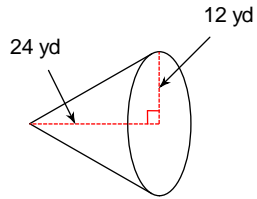

260)

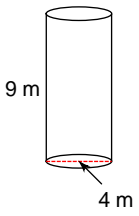

261)

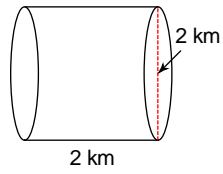

262)

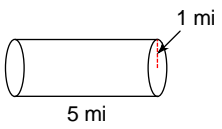

263)

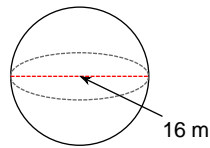

264)

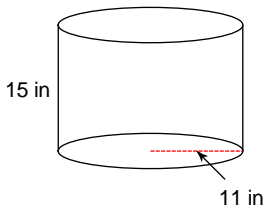

265)

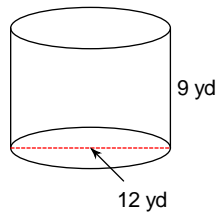

266)

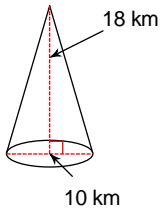

267)

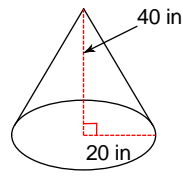

268)

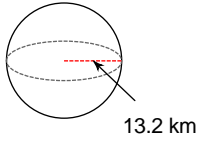

269)

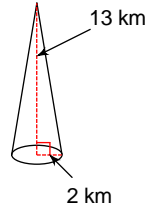

270)

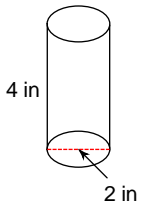

271)

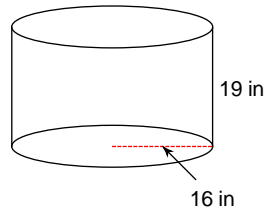

272)

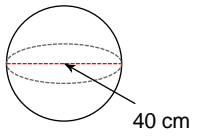

273)

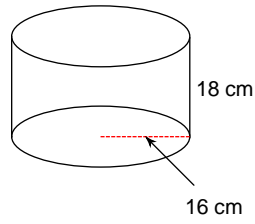

274)

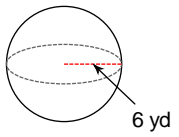

275)

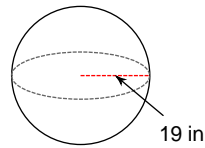

276)

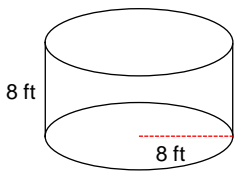

277)

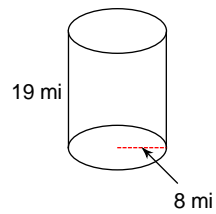

278)

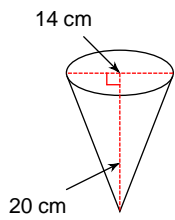

279)

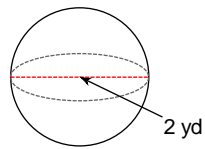

280)

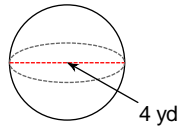

281)

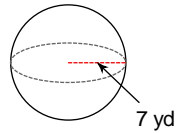

282)

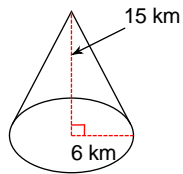

283)

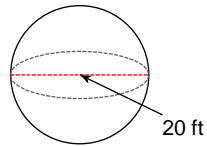

284)

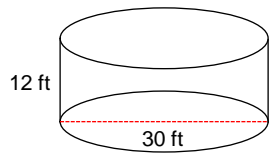

285)

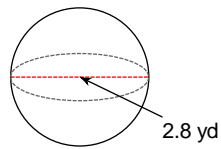

286)

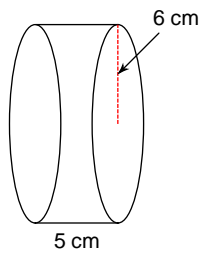

287)

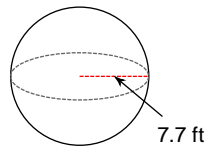

288)

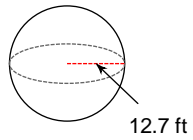

289)

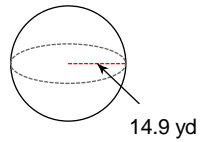

290)

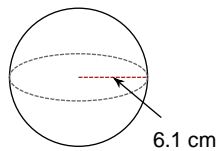

291)

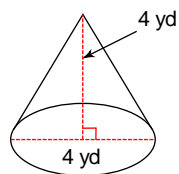

292)

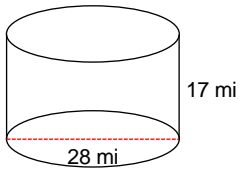

293)

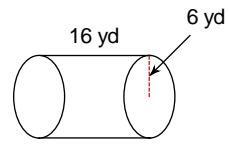

294)

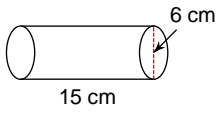

295)

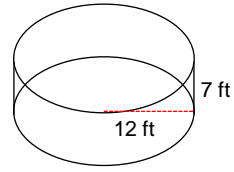

296)

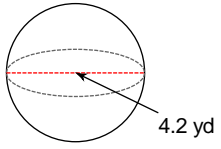

297)

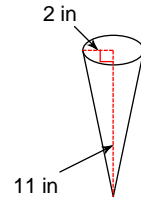

298)

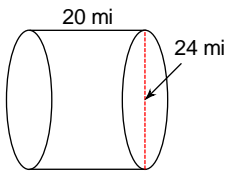

299)

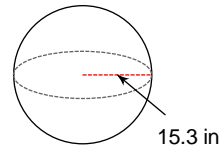

300)

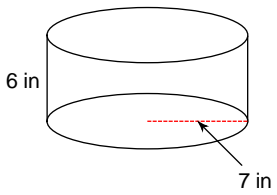

Volume of solid figures

Find the volume of triangular prisms and pyramids, square prism and pyramids, rectangular prism and pyramids:

1)

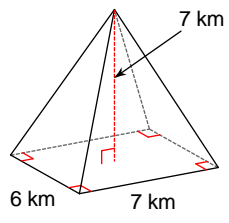

98 km^3

2)

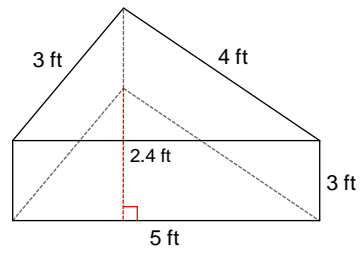

18 ft^3

3)

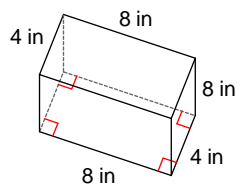

256 in^3

4)

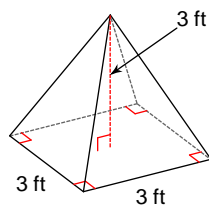

9 ft^3

5)

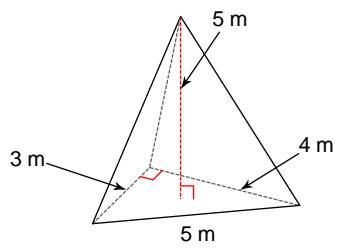

10 m^3

6)

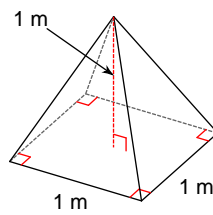

0 m^3

7)

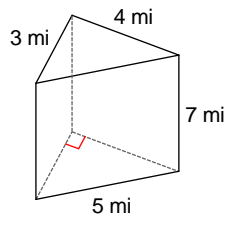

42 mi^3

8)

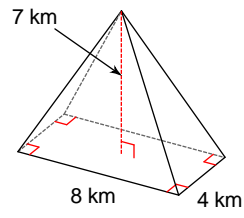

75 km^3

9)

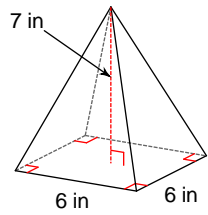

84 in^3

10)

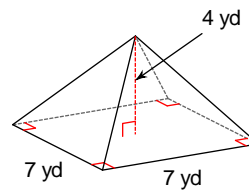

65 yd^3

11)

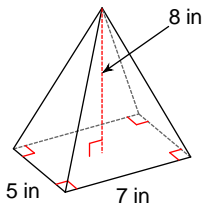

93 in³

12)

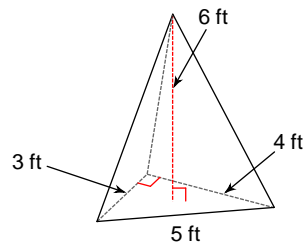

12 ft³

13)

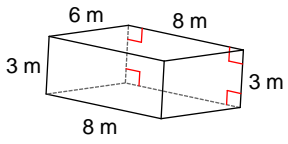

144 m³

14)

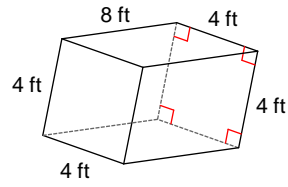

128 ft³

15)

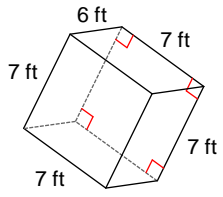

294 ft^3

16)

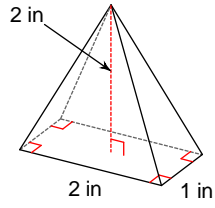

1 in^3

17)

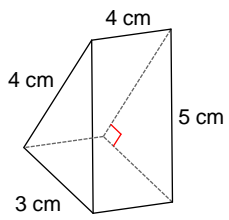

24 cm^3

18)

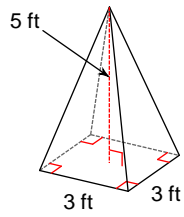

15 ft^3

19)

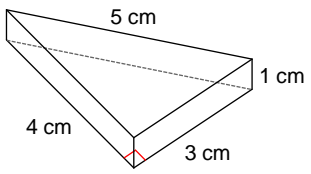

6 cm^3

20)

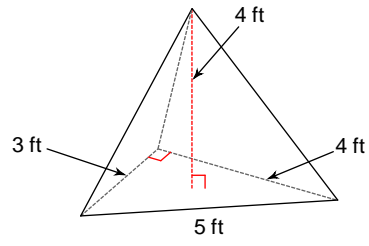

8 ft^3

21)

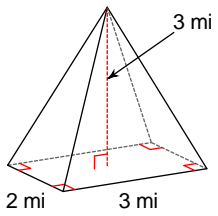

6 mi^3

22)

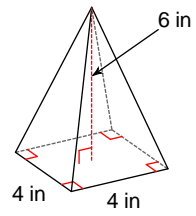

32 in^3

23)

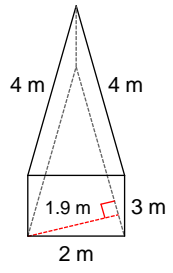

11 m^3

24)

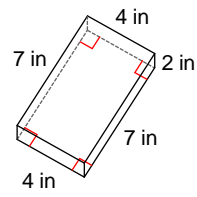

56 in^3

25)

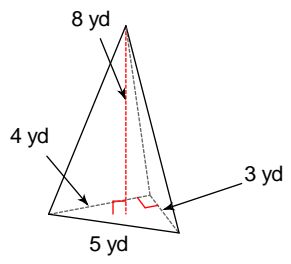

16 yd^3

26)

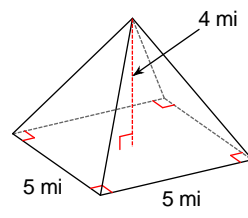

33 mi^3

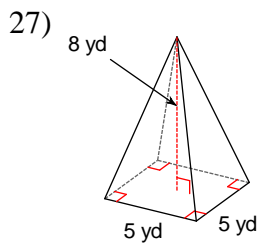

67 yd^3

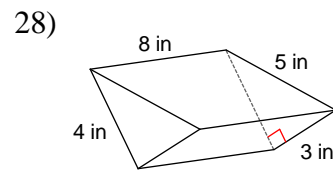

48 in^3

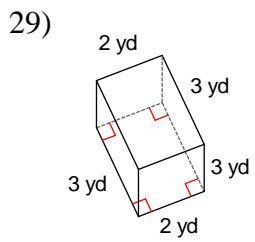

18 yd^3

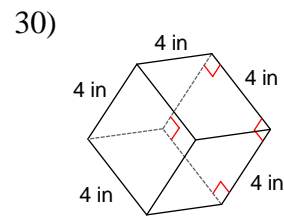

64 in^3

31)

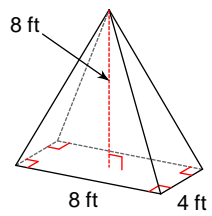

85 ft^3

32)

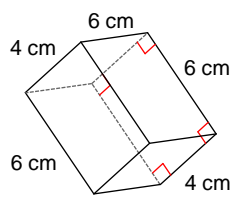

144 cm^3

33)

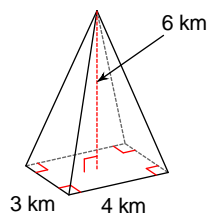

24 km^3

34)

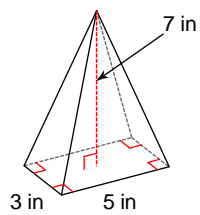

35 in^3

35)

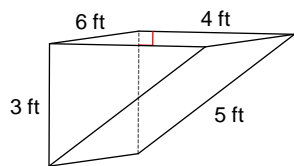

36 ft^3

36)

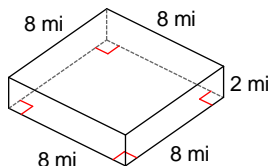

128 mi^3

37)

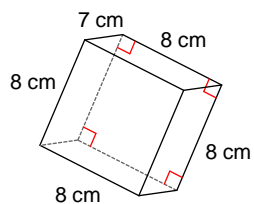

448 cm^3

38)

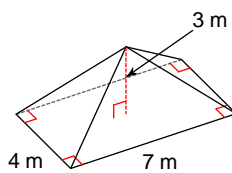

28 m^3

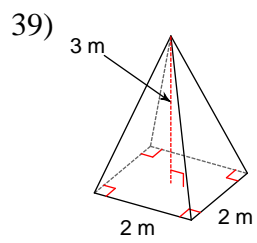

4 m^3

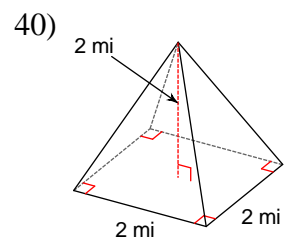

3 mi^3

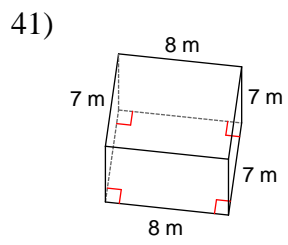

392 m^3

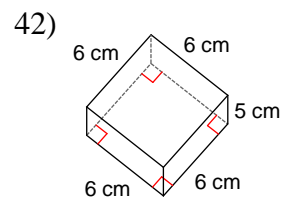

180 cm^3

43)

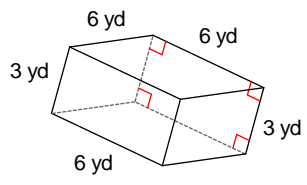

108 yd³

44)

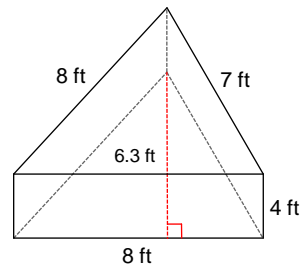

101 ft³

45)

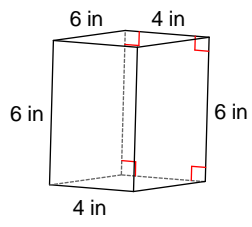

144 in³

46)

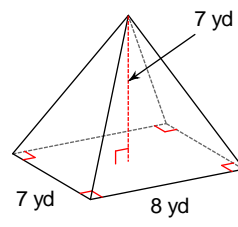

131 yd³

47)

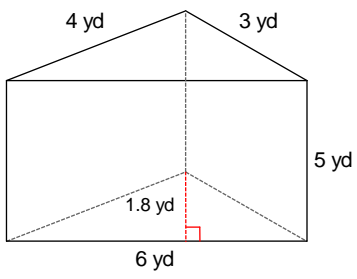

27 yd³

48)

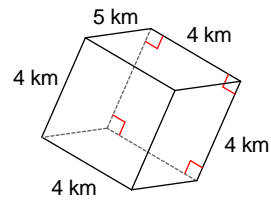

80 km³

49)

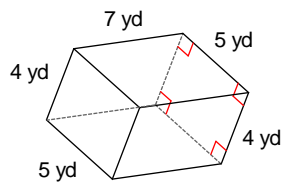

140 yd³

50)

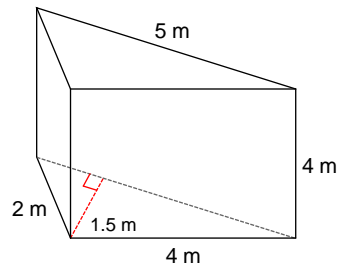

15 m³

51)

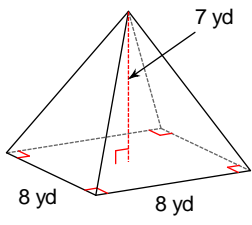

149 yd³

52)

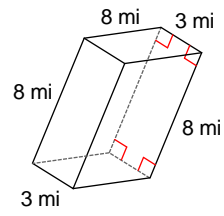

192 mi³

53)

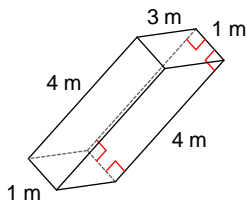

12 m³

54)

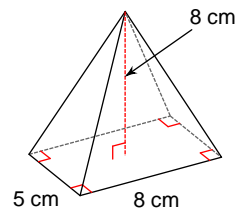

107 cm³

55)

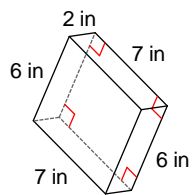

84 in^3

56)

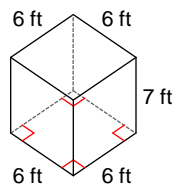

252 ft^3

57)

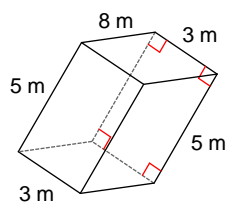

120 m^3

58)

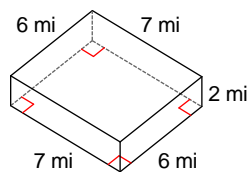

84 mi^3

59)

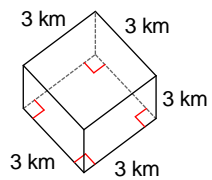

27 km^3

60)

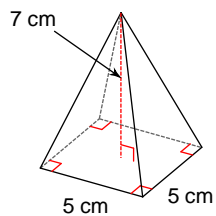

58 cm^3

61)

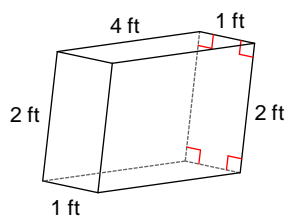

8 ft^3

62)

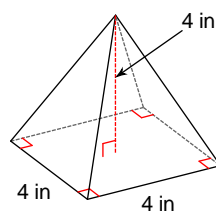

21 in^3

63)

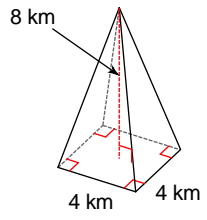

43 km^3

64)

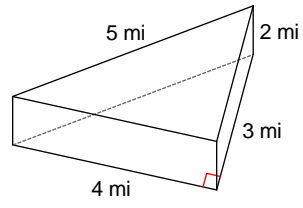

12 mi^3

65)

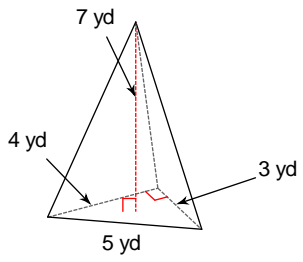

14 yd³

66)

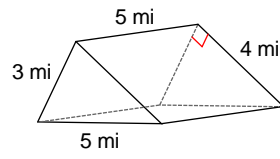

30 mi³

67)

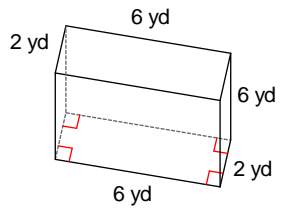

72 yd^3

68)

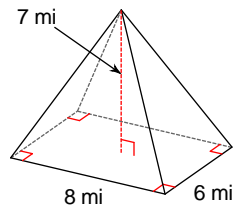

112 mi^3

69)

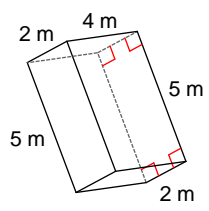

40 m^3

70)

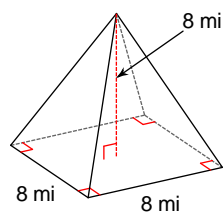

171 mi^3

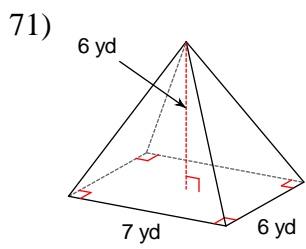

84 yd^3

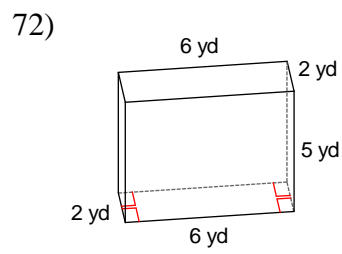

60 yd^3

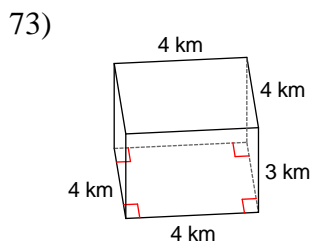

48 km^3

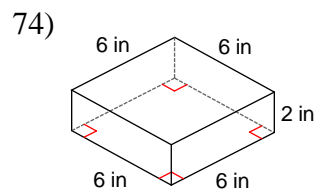

72 in^3

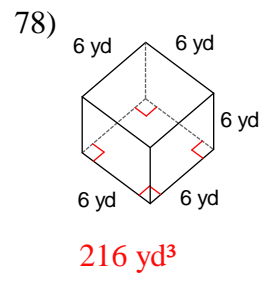
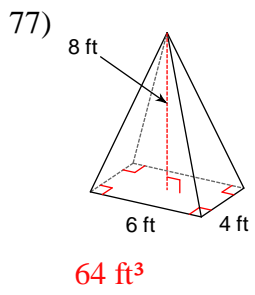
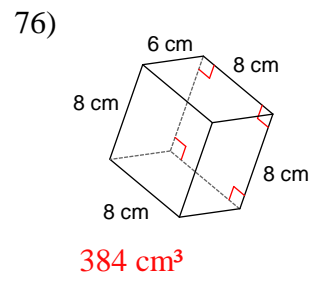
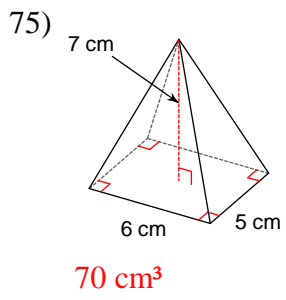

79)

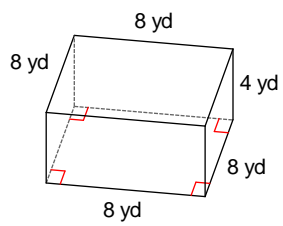

256 yd³

80)

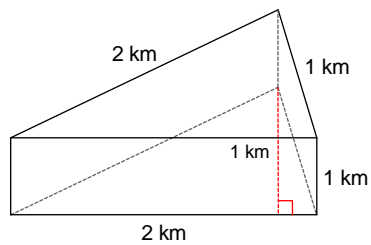

1 km³

81)

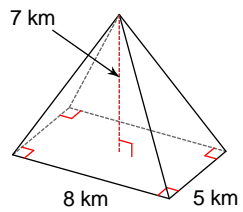

93 km³

82)

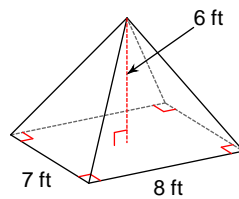

112 ft³

83)

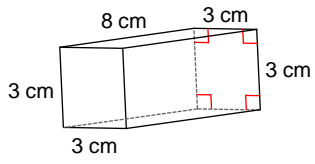

72 cm^3

84)

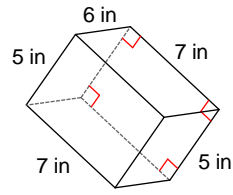

210 in^3

85)

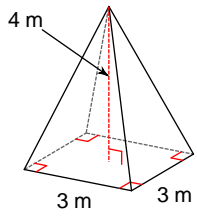

12 m^3

86)

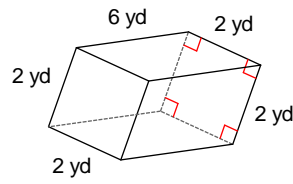

24 yd^3

87)

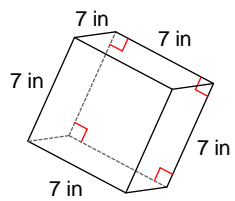

343 in^3

88)

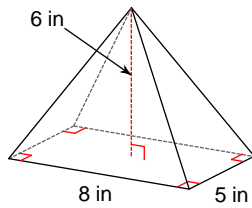

80 in^3

89)

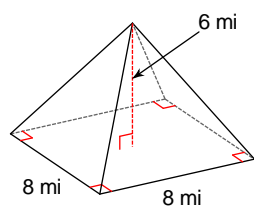

128 mi^3

90)

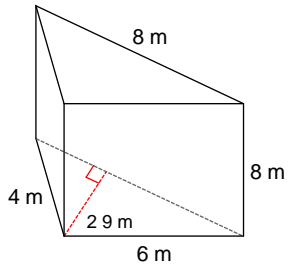

93 m^3

91)

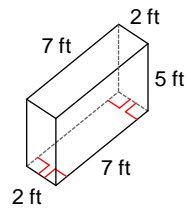

70 ft^3

92)

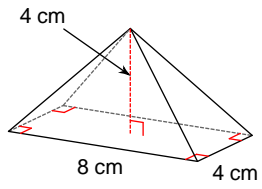

43 cm^3

93)

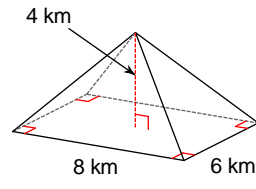

64 km^3

94)

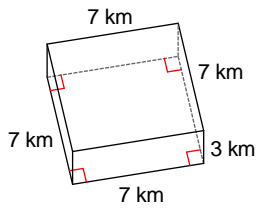

147 km³

95)

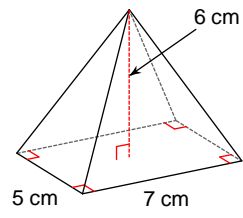

70 cm³

96)

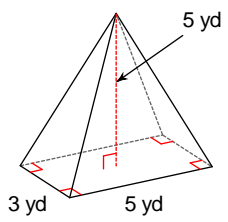

25 yd³

97)

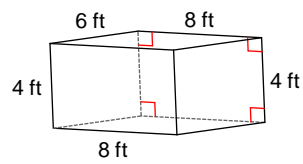

192 ft³

98)

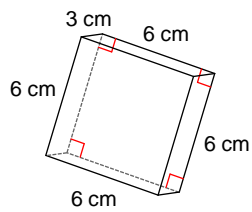

108 cm^3

99)

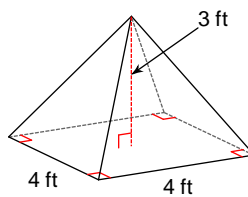

16 ft^3

100)

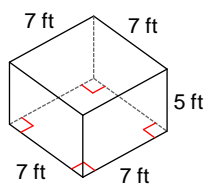

245 ft^3

Find the volume of trapezoidal prisms, pentagonal prisms and pyramids, hexagonal prisms and pyramids:

101)

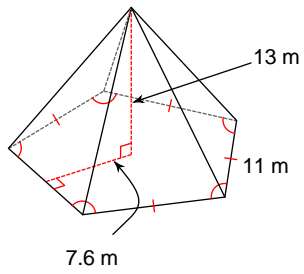

905.67 m³

102)

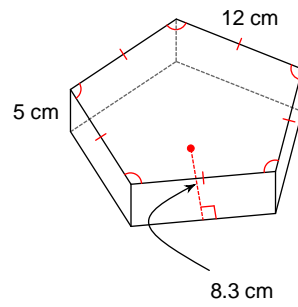

1245 cm³

103)

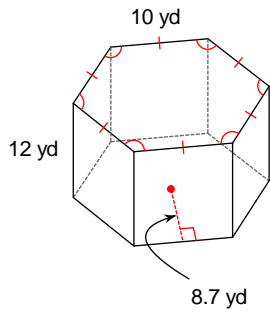

3132 yd³

104)

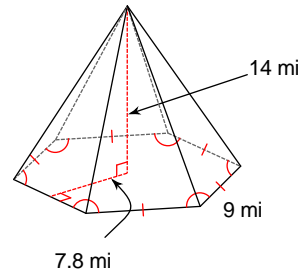

982.8 mi³

105)

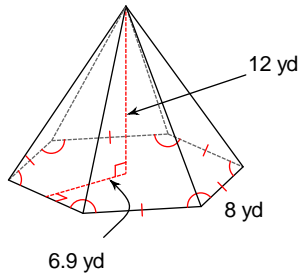

662.4 yd³

106)

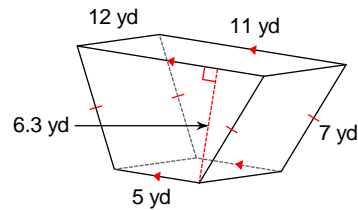

604.8 yd³

107)

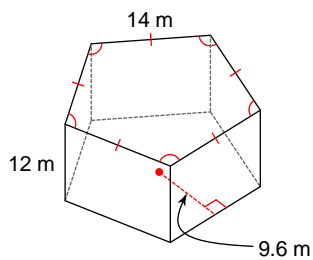

4032 m³

108)

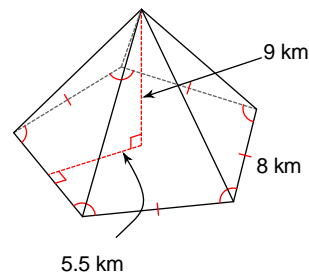

330 km³

109)

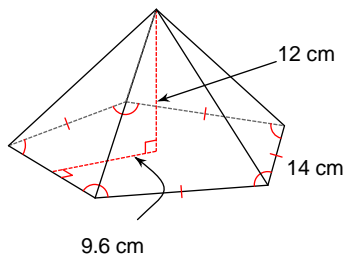

1344 cm³

110)

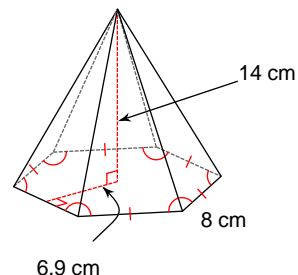

772.8 cm³

111)

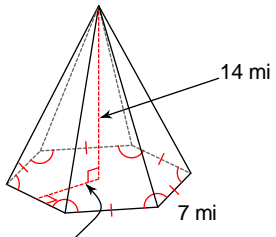

6.1 mi
597.8 mi³

112)

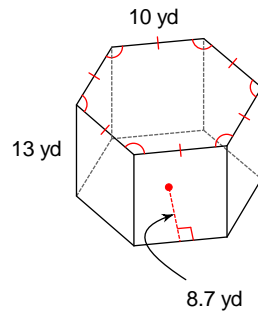

3393 yd³

113)

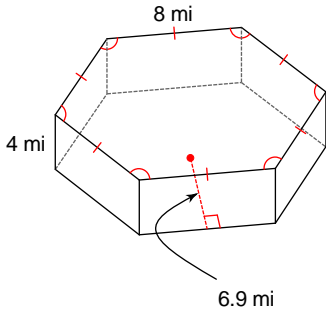

662.4 mi³

114)

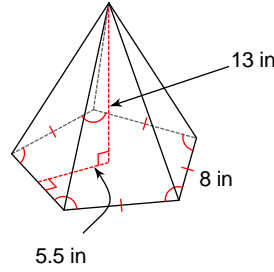

476.67 in³

115)

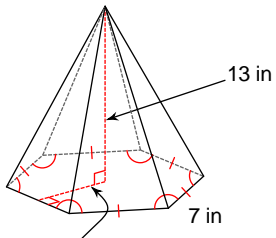

6.1 in
555.1 in³

116)

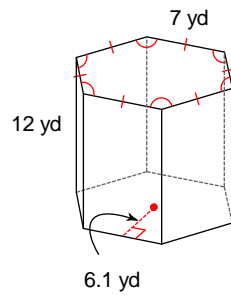

1537.2 yd³

117)

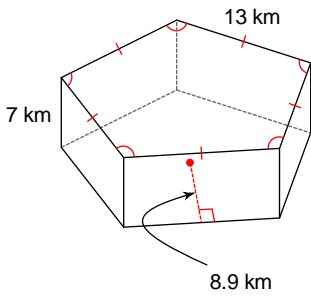

2024.75 km³

118)

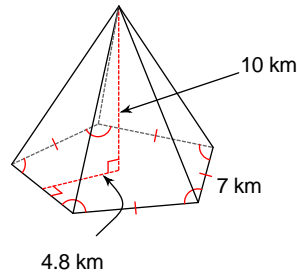

280 km³

119)

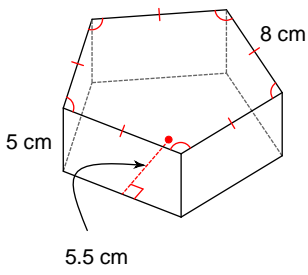

5.5 cm
550 cm³

120)

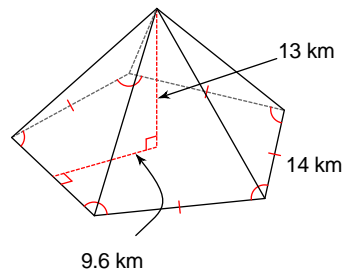

9.6 km
1456 km³

121)

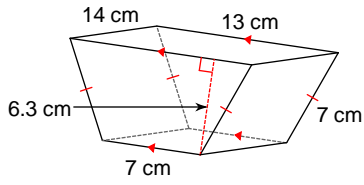

882 cm³

122)

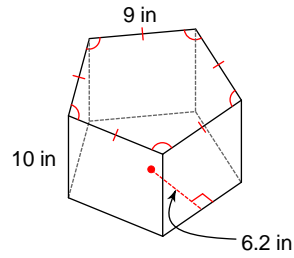

1395 in³

123)

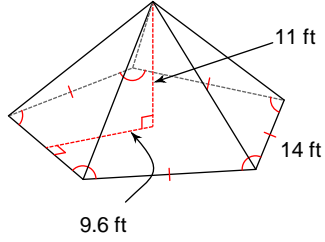

1232 ft³

124)

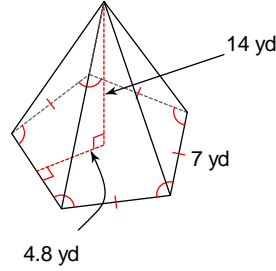

392 yd³

125)

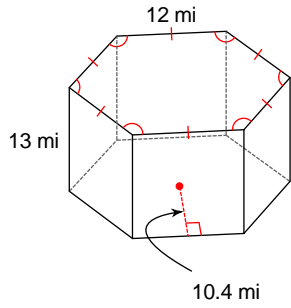

4867.2 mi³

126)

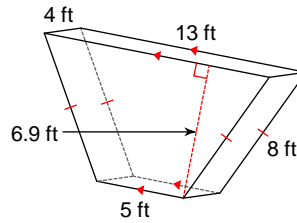

248.4 ft³

127)

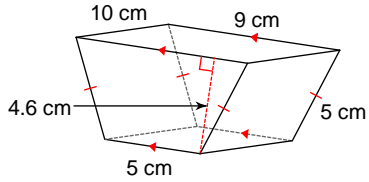

322 cm³

128)

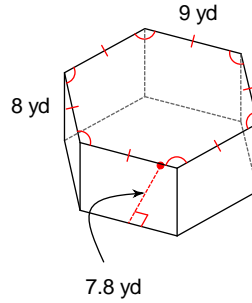

1684.8 yd³

129)

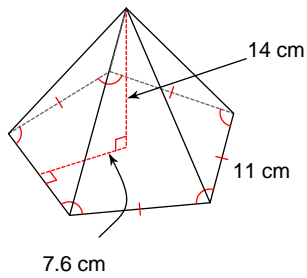

975.33 cm³

130)

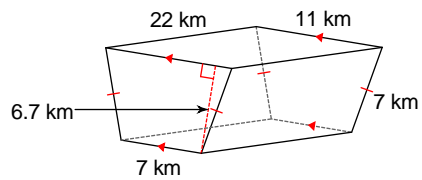

1326.6 km³

131)

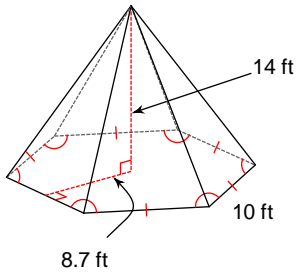

1218 ft³

132)

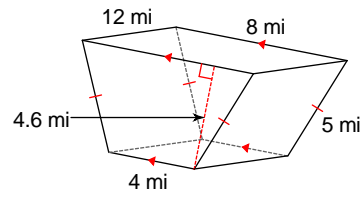

331.2 mi³

133)

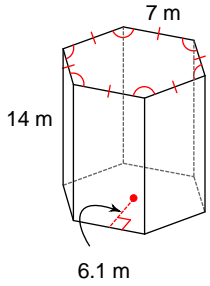

1793.4 m³

134)

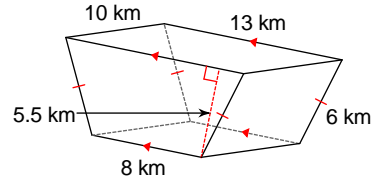

577.5 km³

135)

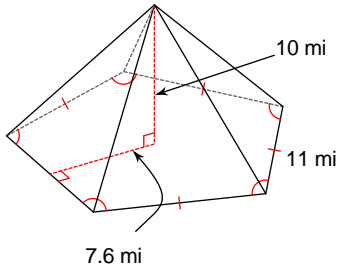

696.67 mi³

136)

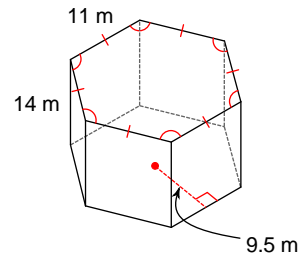

4389 m³

137)

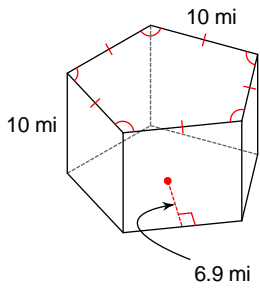

1725 mi³

138)

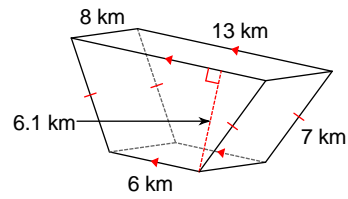

463.6 km³

139)

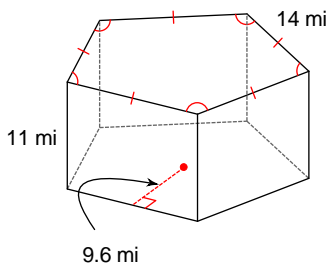

3696 mi³

140)

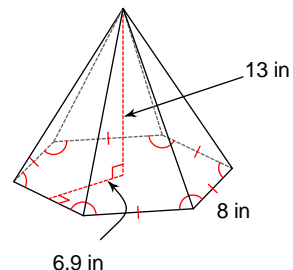

717.6 in³

141)

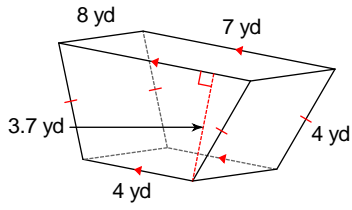

162.8 yd³

142)

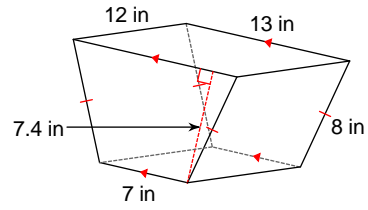

888 in³

143)

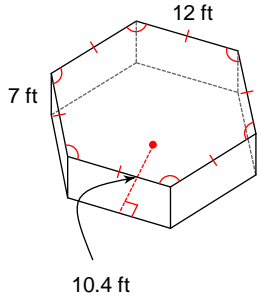

2620.8 ft³

144)

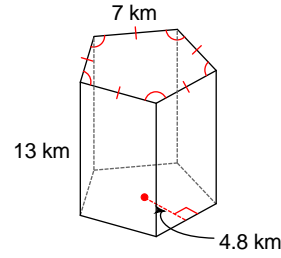

1092 km³

145)

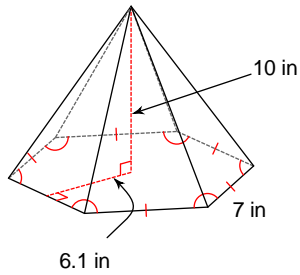

427 in³

146)

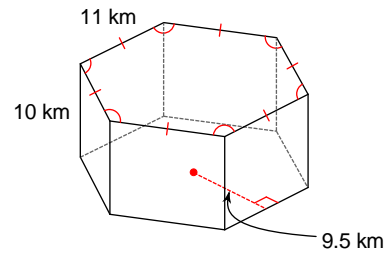

3135 km³

147)

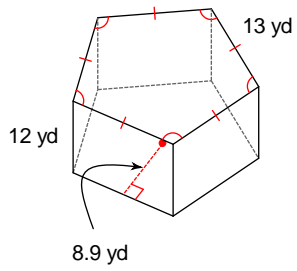

3471 yd³

148)

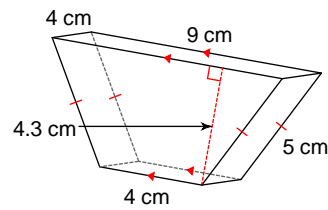

111.8 cm³

149)

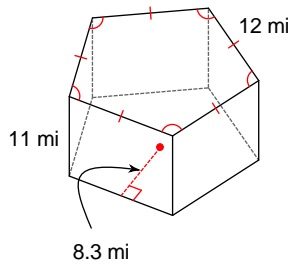

2739 mi³

150)

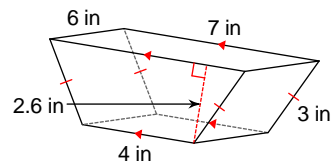

85.8 in³

151)

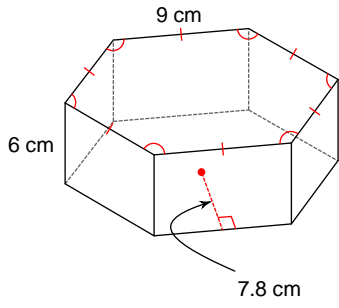

1263.6 cm³

152)

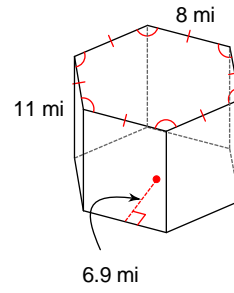

1821.6 mi³

153)

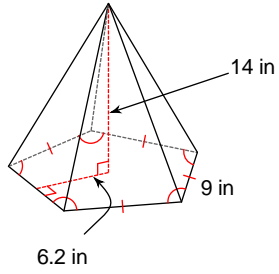

651 in³

154)

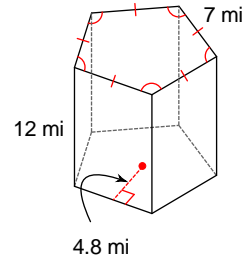

1008 mi³

155)

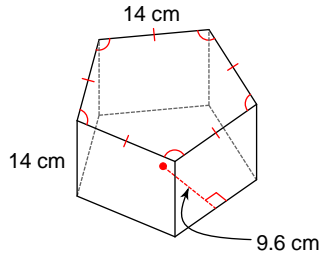

4704 cm³

156)

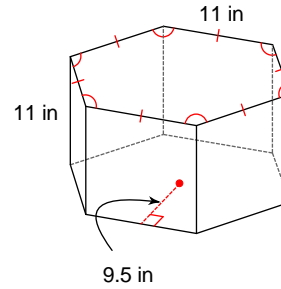

3448.5 in³

157)

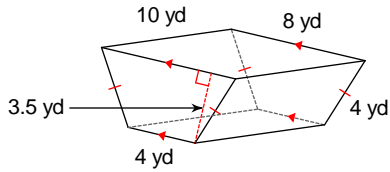

210 yd³

158)

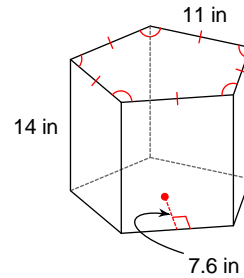

2926 in³

159)

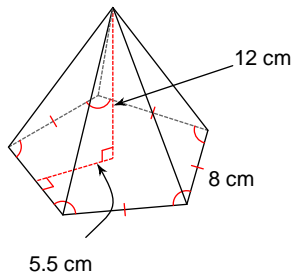

440 cm³

160)

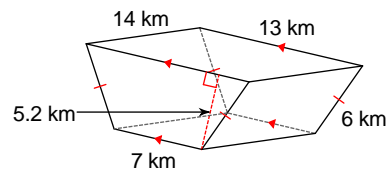

728 km³

161)

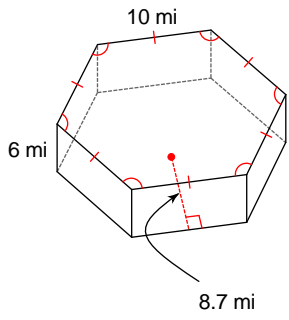

1566 mi³

162)

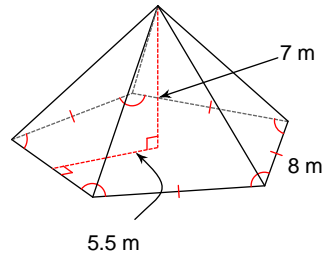

256.67 m³

163)

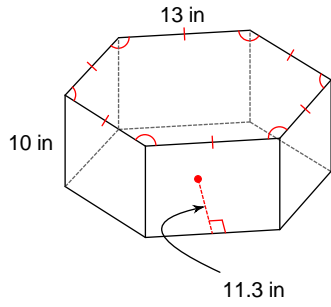

4407 in³

164)

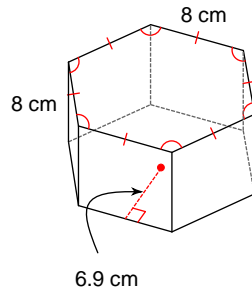

1324.8 cm³

165)

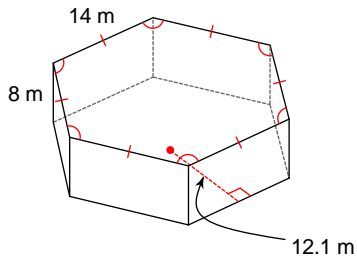

4065.6 m³

166)

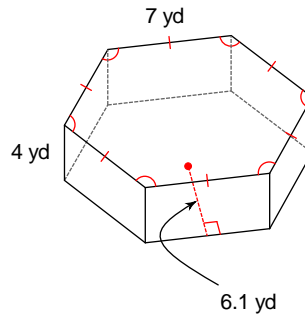

512.4 yd³

167)

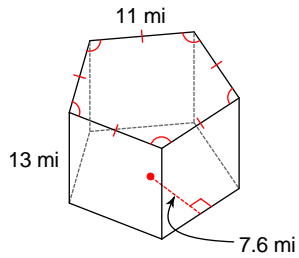

2717 mi³

168)

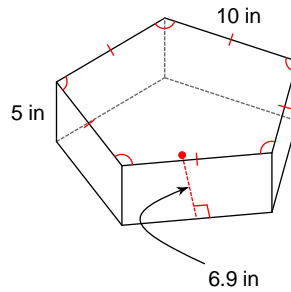

862.5 in³

169)

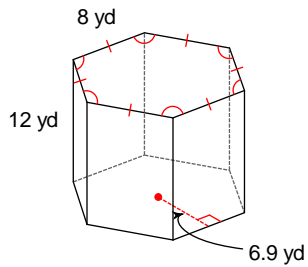

1987.2 yd³

170)

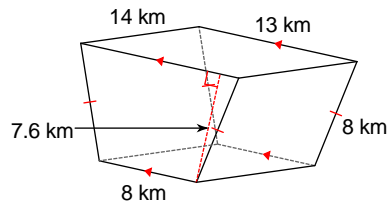

1117.2 km³

171)

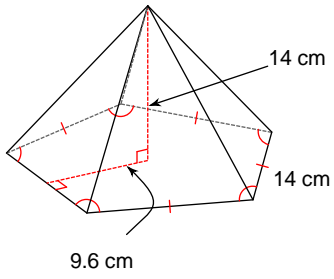

1568 cm³

172)

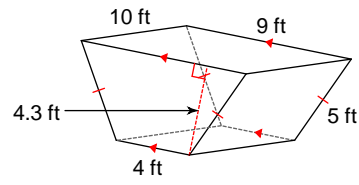

279.5 ft³

173)

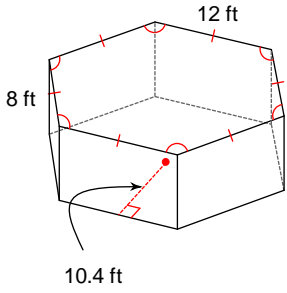

2995.2 ft³

174)

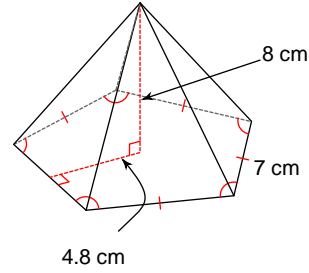

224 cm³

175)

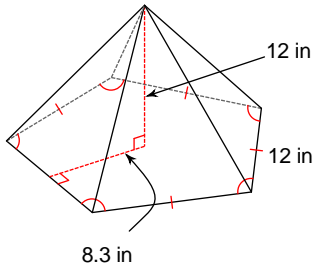

996 in³

176)

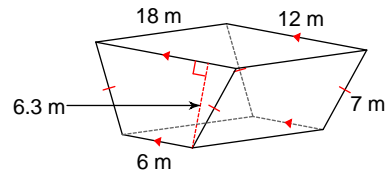

1020.6 m³

177)

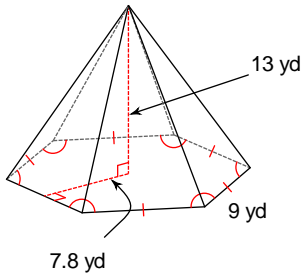

912.6 yd³

178)

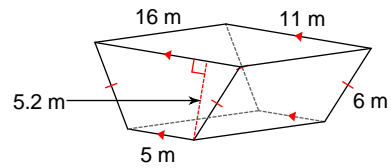

665.6 m³

179)

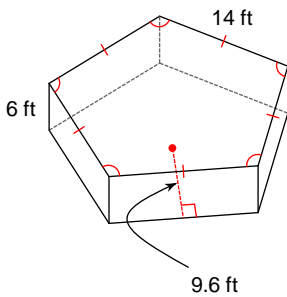

2016 ft³

180)

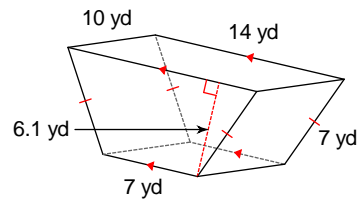

640.5 yd³

181)

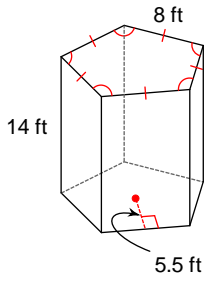

1540 ft³

182)

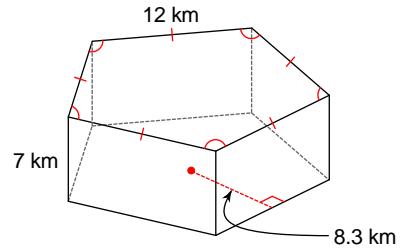

1743 km³

183)

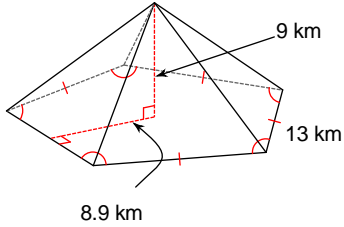

867.75 km³

184)

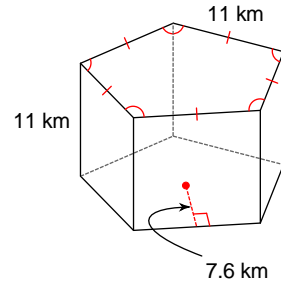

2299 km³

185)

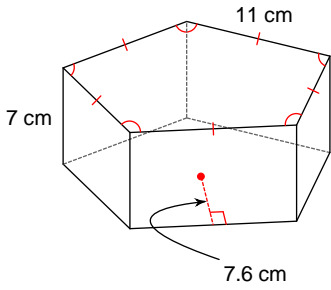

1463 cm³

186)

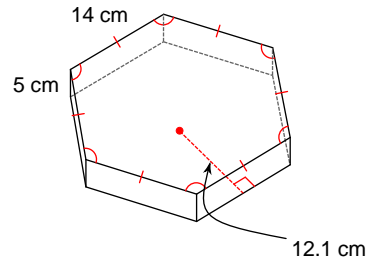

2541 cm³

187)

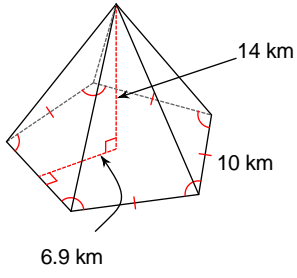

805 km³

188)

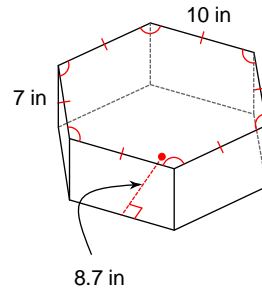

1827 in³

189)

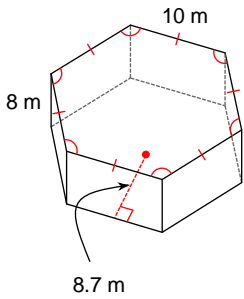

2088 m³

190)

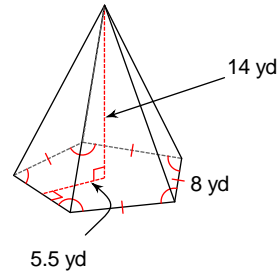

513.33 yd³

191)

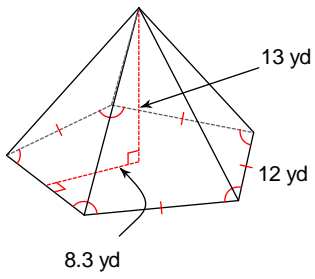

192)

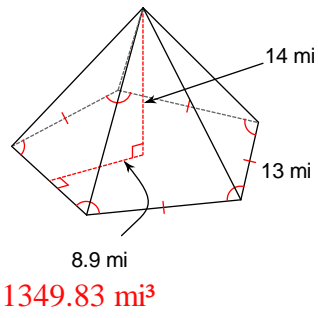

193)

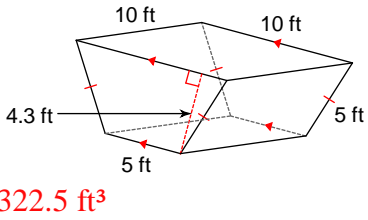

194)

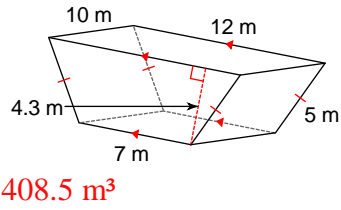

195)

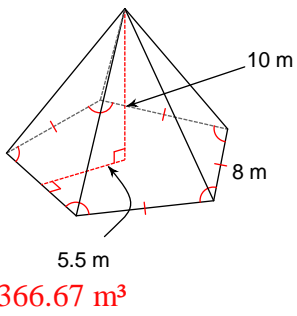

196)

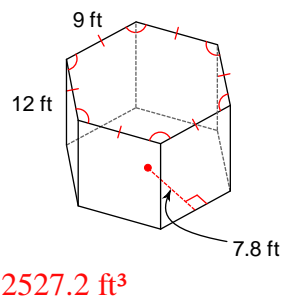

197)

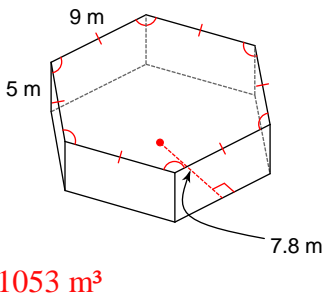

198)

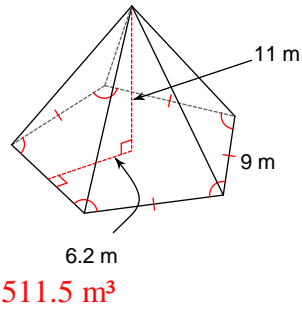

199)

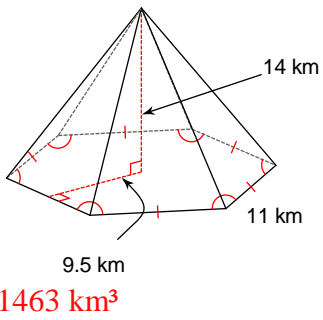

200)

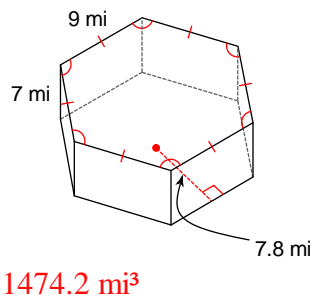

Find the volume of cylinders, cones and spheres:

201)

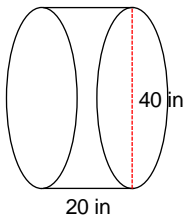

25132.7 in³

203)

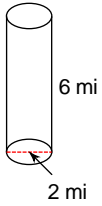

18.85 mi³

205)

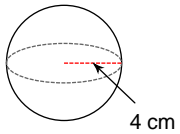

268.08 cm³

207)

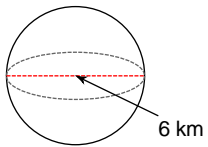

113.1 km³

209)

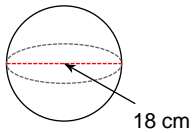

3053.63 cm³

211)

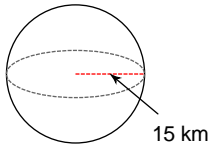

14137.2 km³

213)

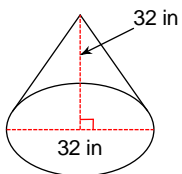

8578.64 in³

202)

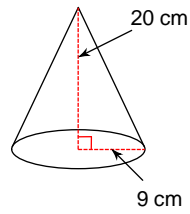

1696.46 cm³

204)

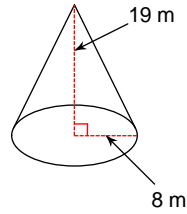

1273.39 m³

206)

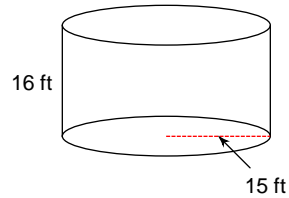

11309.7 ft³

208)

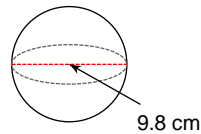

492.81 cm³

210)

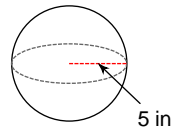

523.6 in³

212)

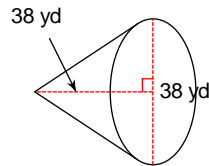

14365.5 yd³

214)

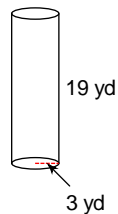

537.21 yd³

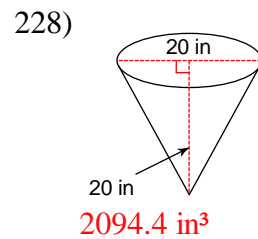
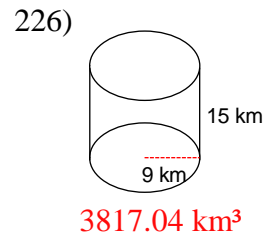
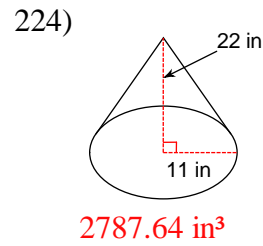
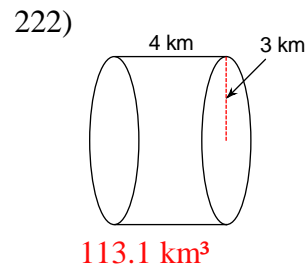
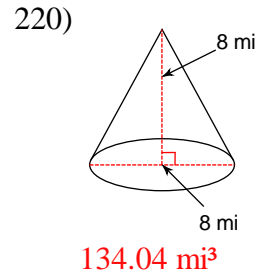
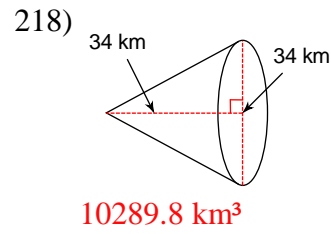
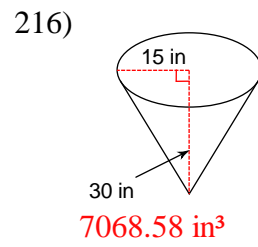
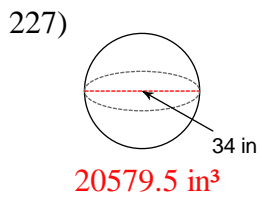
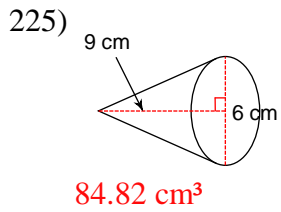
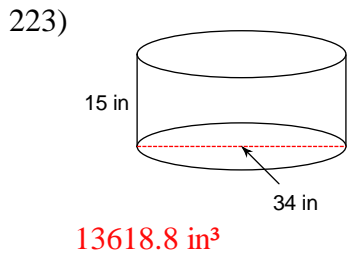
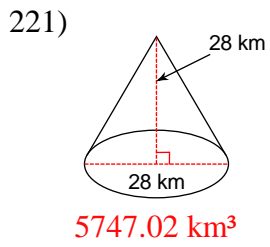
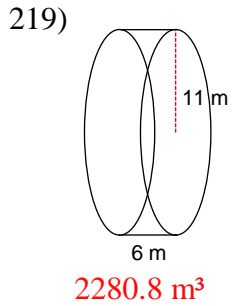
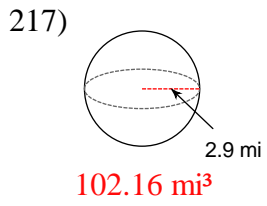
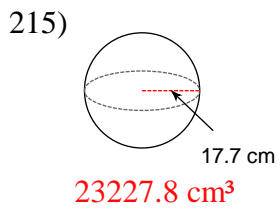

229)

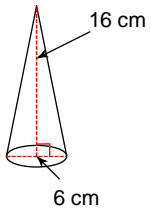

150.8 cm³

230)

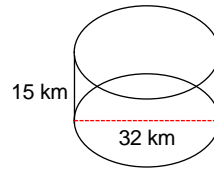

12063.7 km³

231)

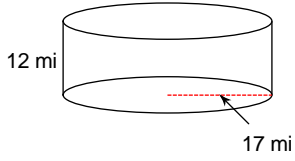

10895 mi³

232)

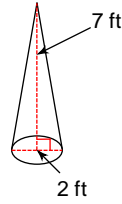

7.33 ft³

233)

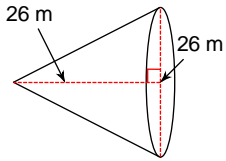

4601.39 m³

234)

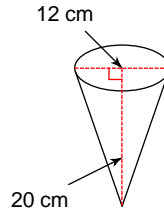

753.98 cm³

235)

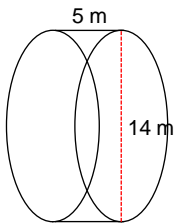

769.69 m³

236)

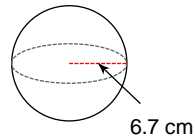

1259.83 cm³

237)

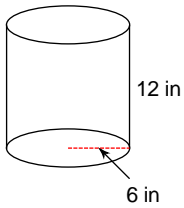

1357.17 in³

238)

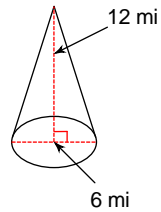

113.1 mi³

239)

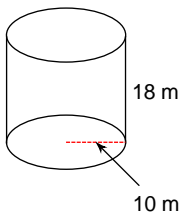

5654.87 m³

240)

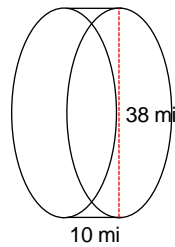

11341.2 mi³

241)

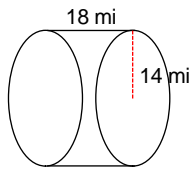

11083.5 mi³

242)

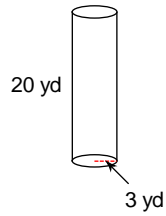

565.49 yd³

243)

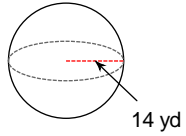

11494 yd³

244)

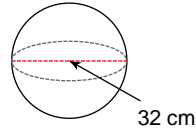

17157.3 cm³

245)

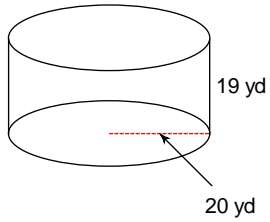

23876.1 yd³

246)

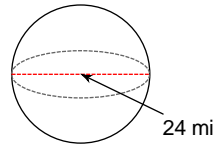

7238.23 mi³

247)

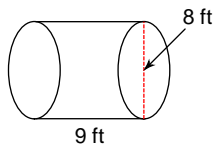

452.39 ft³

248)

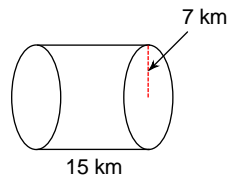

2309.07 km³

249)

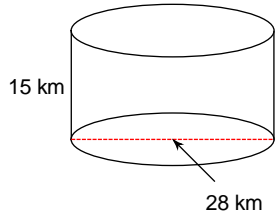

9236.28 km³

250)

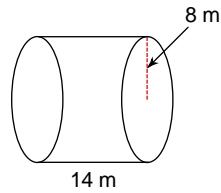

2814.87 m³

251)

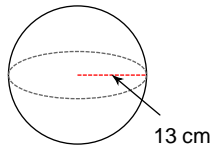

9202.77 cm³

252)

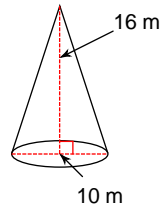

418.88 m³

253)

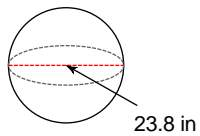

7058.78 in³

254)

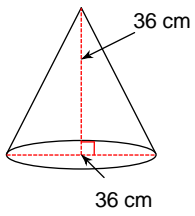

12214.5 cm³

255)

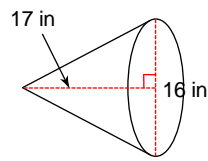

1139.35 in³

256)

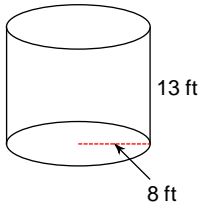

2613.81 ft³

257)

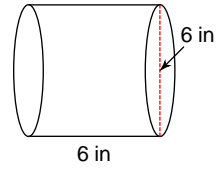

169.65 in³

258)

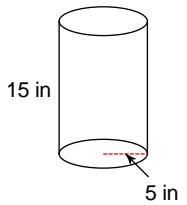

1178.1 in³

259)

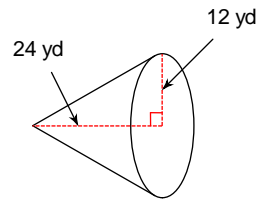

3619.11 yd³

260)

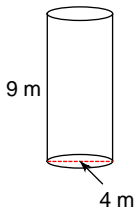

113.1 m³

261)

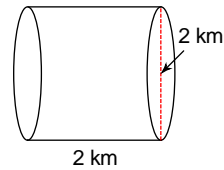

6.28 km³

262)

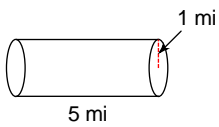

15.71 mi³

263)

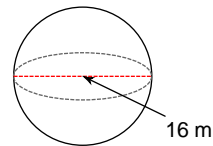

2144.66 m³

264)

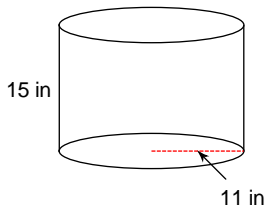

5701.99 in³

265)

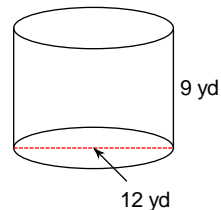

1017.88 yd³

266)

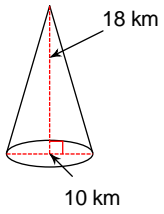

471.24 km^3

267)

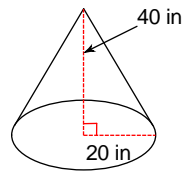

16755.2 in^3

268)

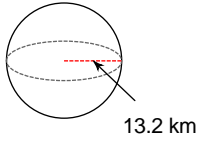

9634.08 km^3

269)

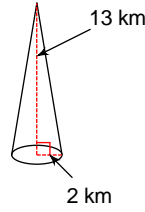

54.45 km^3

270)

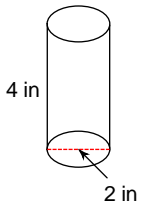

12.57 in^3

271)

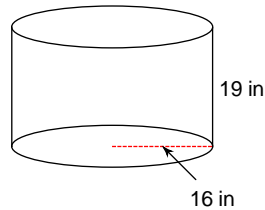

15280.7 in^3

272)

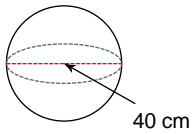

33510.3 cm^3

273)

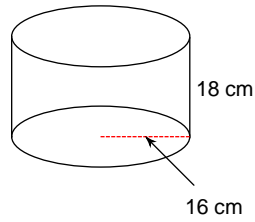

14476.5 cm^3

274)

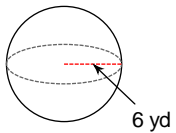

904.78 yd^3

275)

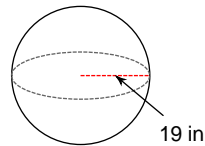

28730.9 in^3

276)

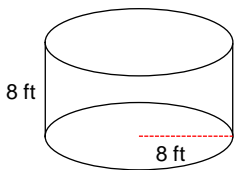

1608.5 ft^3

277)

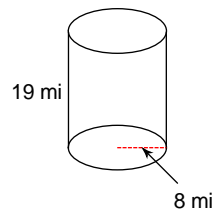

3820.18 mi^3

278)

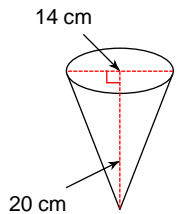

1026.25 cm³

279)

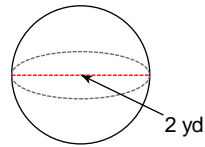

4.19 yd³

280)

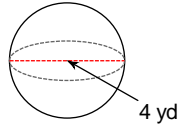

33.51 yd³

281)

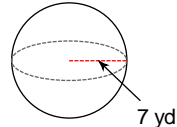

1436.76 yd³

282)

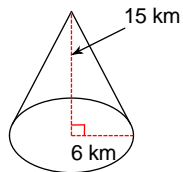

565.49 km³

283)

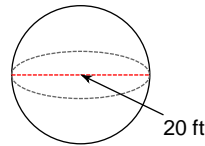

4188.79 ft³

284)

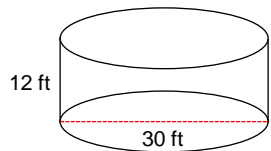

8482.3 ft³

285)

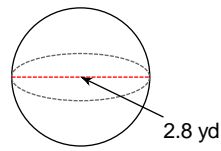

11.49 yd³

286)

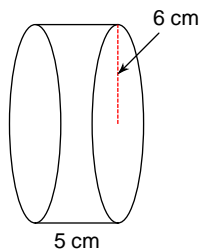

565.49 cm³

287)

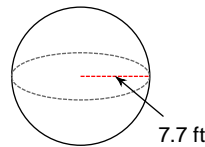

1912.32 ft³

288)

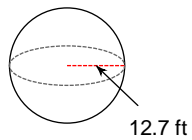

8580.25 ft³

289)

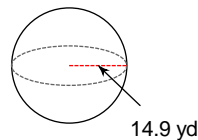

13856.3 yd³

290)

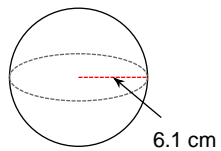

950.78 cm³

291)

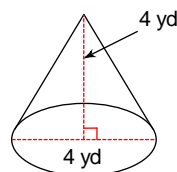

16.76 yd³

292)

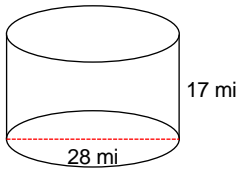

10467.8 mi^3

293)

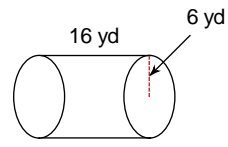

1809.56 yd^3

294)

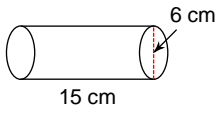

424.12 cm^3

295)

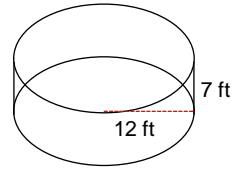

3166.73 ft^3

296)

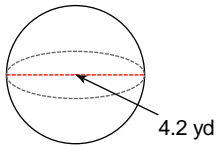

38.79 yd^3

297)

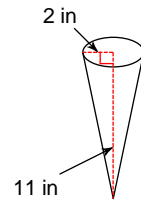

46.08 in^3

298)

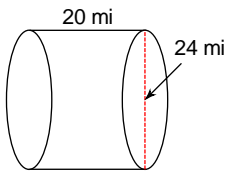

9047.79 mi^3

299)

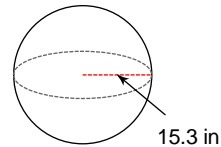

15002.5 in^3

300)

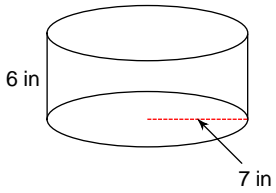

923.63 in^3